

Weatherly No.
Catalog No.
Edition/Édition
Supersedes

630
431-2088
2017
431-2088 (2015)

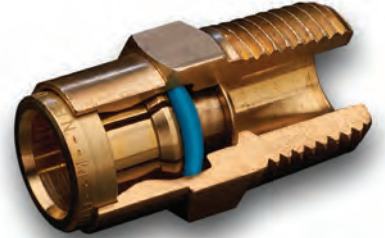

BRASS PRODUCTS

2017 AUTOMOTIVE CATALOG

Gates has the products to fit your fleet needs.

For related hydraulic products please refer to the Gates Hydraulic and Fleet Hose Products catalog 431-2080.

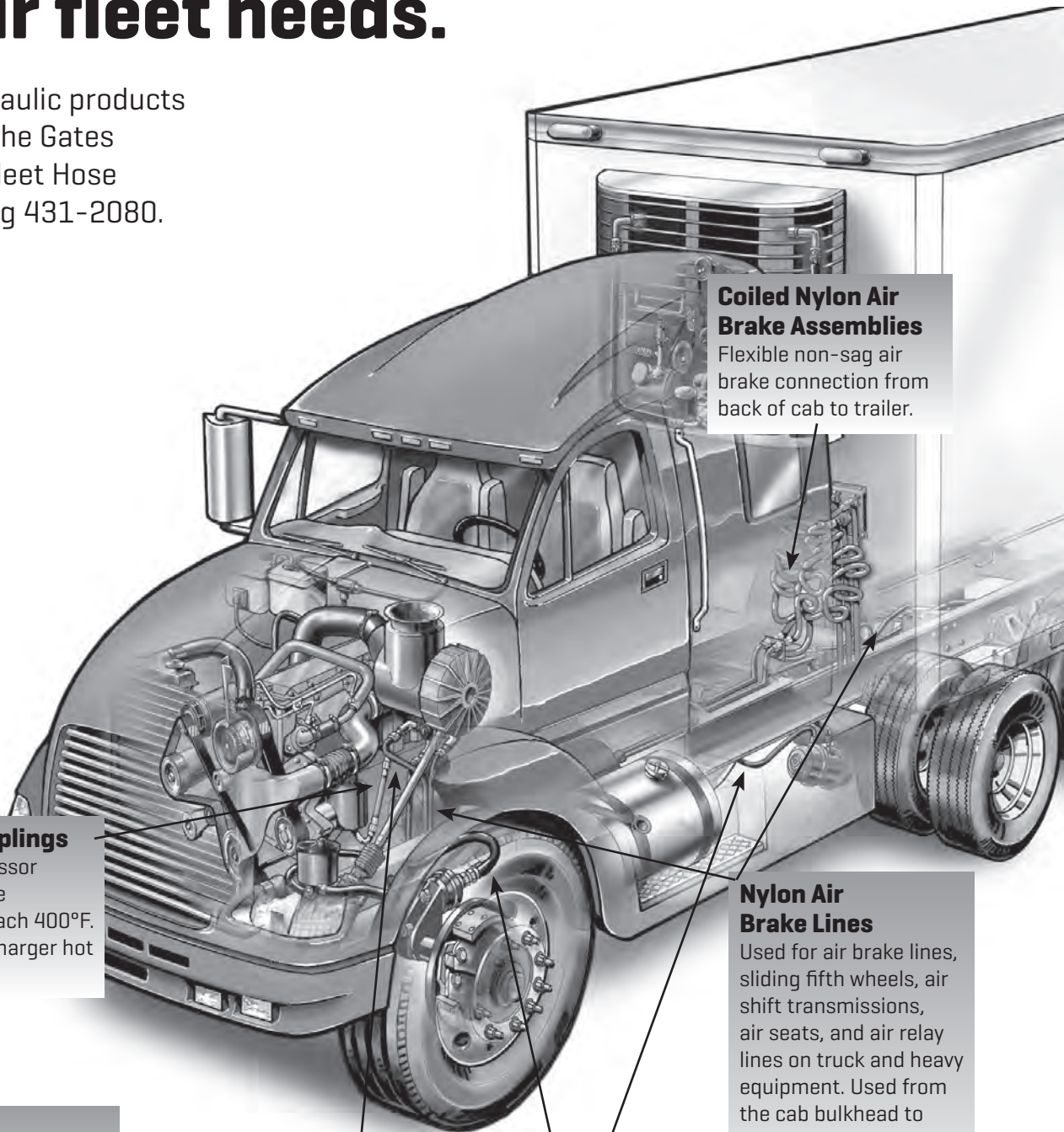

PTFE Hose & Couplings

For air brake compressor discharge lines where temperatures can reach 400°F. Also used for turbo charger hot oil lines.

Lock-On Hose (LOL & LOC)

Used for low-pressure oil and air lines under the hood or on the chassis. Not for use in air brake applications.

C5 (SAE100R5) Hose & Couplings

Used under the hood for air and oil lines where the hose could come into contact with heat sources. On air brake lines, it is used after the PTFE hose.

Rubber Air Brake Assemblies

Flexible hose used between the valve and air brake chamber.

Coiled Nylon Air Brake Assemblies

Flexible non-sag air brake connection from back of cab to trailer.

Nylon Air Brake Lines

Used for air brake lines, sliding fifth wheels, air shift transmissions, air seats, and air relay lines on truck and heavy equipment. Used from the cab bulkhead to rear of trailer. Never use near heat source or in areas where corrosives are present.





Table of Contents

Quality Brass Products from Gates	2
Coupling Visual Index	3-9
Thread ID Chart	10
Getting the Best Service Life	11
Gates Global Part Numbering System	12-15
Torque Recommendations for Brass Couplings	16
Equipment & Tools	17
Air Brake Nylon Tubing	18-19
Air Brake Copper Tubing Compression - D.O.T.	20-26
Air Brake SureLok™ - D.O.T.	27-39
Composite Air Brake SureLok™ - D.O.T.	40-41
Air Brake Compression Fittings - D.O.T.	42-50
Air Brake Couplings for Rubber Hose	51-56
Valves	57-81
Brass Lock-On Field Attachable Couplings for LOC & LOL Hose	82-89
Single Bead	90-94
Barb Stem	95-96
Inverted Flare	97-104
Automotive Adapters	105-114
Copper Tubing Industrial Compression	115-122
Industrial SureLok™	123-129
Mini-Barbed Tube	130-135
Poly Industrial Compression	136-139
Pipe Adapters	140-152
Adapters SAE Flare	153-163
Threaded Sleeve	164-166
Kits & Assortments	167
Competitive Interchange	168-183
Part Number Index	184-194

LIMITED WARRANTY FOR THE LIFE OF THE MERCHANDISE

Merchandise is warranted to be free from defects in material or workmanship for the life of the merchandise. Damages from misuse, abuse or gradual wear from normal use are excluded from this warranty. Gates Corporation will, at its option, replace or repair any merchandise proved defective in material or workmanship, or both, during the warranty period. This is the exclusive remedy. For warranty service please contact the Automotive Labor Claims Department, Gates Corporation, 1551 Wewatta Street, Denver, CO 80202. ALL OTHER EXPRESS AND IMPLIED WARRANTIES, INCLUDING THOSE OF MERCHANTABILITY AND FITNESS FOR A PARTICULAR PURPOSE, HEREBY IS DISCLAIMED TO THE EXTENT SUCH EXCLUSION IS PERMITTED BY LAW. LIABILITY FOR CONSEQUENTIAL, INDIRECT, SPECIAL, OR INCIDENTAL DAMAGES HEREBY IS DISCLAIMED TO THE EXTENT SUCH EXCLUSION IS PERMITTED BY LAW. Some states do not allow the exclusion or limitation of incidental or consequential damages, and some states do not allow limitations on how long an implied warranty lasts, so the above limitation and exclusion may not apply to you. This warranty gives you specific legal rights and you may also have other rights, which vary from state to state. We hereby certify that the goods will be produced in compliance with requirements of Sections 6 and 7 of the Fair Labor Standards Act of 1938, as amended, and of regulations and orders of the U.S. Department of Labor issued under Section 14 thereof.

International Symbols used in this catalog as column headings

DESC Description	A Tube Diameter
 Tube Inside Diameter (I.D.)	C Cut-Off
 Tube Outside Diameter (O.D.)	D Mounting Hole
 Thread Size	H1 Stem Hex
 Working Pressure (psi)	H2 Nut Hex
	L Length
	T Drop



Gates Corporation
1551 Wewatta Street
Denver, Colorado 80202-6173

Copyright 2017
Printed in U.S. of America

AIR BRAKE NYLON TUBING
AIR BRAKE COPPER TUBING
AIR BRAKE SURELOK
COMPOSITE AIR BRAKE SURELOK
AIR BRAKE COMPRESSION FITTINGS
AIR BRAKE COUPLINGS FOR RUBBER HOSE
VALVES
BRASS LOCK-ON FIELD ATTACHABLE COUPLINGS
SINGLE BEAD
BARB STEM
INVERTED FLARE
AUTOMOTIVE ADAPTERS
COPPER TUBING INDUSTRIAL COMPRESSION
INDUSTRIAL SURELOK
MINI-BARBED TUBE
POLY INDUSTRIAL COMPRESSION
PIPE ADAPTERS
ADAPTERS SAE FLARE
THREADED SLEEVE
KITS & ASSORTMENTS

Quality Brass Products from Gates

AIR BRAKE NYLON TUBING
AIR BRAKE COPPER TUBING
AIR BRAKE SURELOK
COMPOSITE AIR BRAKE SURELOK
AIR BRAKE COMPRESSION FITTINGS
AIR BRAKE COUPLINGS FOR RUBBER HOSE
VALVES
BRASS LOCK-ON FIELD ATTACHABLE COUPLINGS
SINGLE BEAD
BARB STEM
INVERTED FLARE
AUTOMOTIVE ADAPTERS
COPPER TUBING INDUSTRIAL COMPRESSION
INDUSTRIAL SURELOK
MINI-BARBED TUBE
POLY INDUSTRIAL COMPRESSION
PIPE ADAPTERS
ADAPTERS SAE FLARE
THREADED SLEEVE
KITS & ASSORTMENTS

Not all brass adapters are alike. Unlike cheap offshore-produced forged, cast or continuous cast fittings, Gates brass products are manufactured only from the highest-quality, domestic-produced bar stock of C36000 copper alloy with just 2.6% lead content. This premium bar stock meets ASTM B16, SAE J461 and J463, and UNS C36000 standards.

All finished parts are precision-machined to meet or exceed all applicable SAE standards, and come Safe Drinking Water Act (SDWA) compliant thanks to lead-free bodies and nuts. Pipe threads meet all Dryseal American National Standard Taper standards, and all parts are inspected, tested and tracked by manufacturing lot for maximum performance and safety.

Hot Extrusion

A cast billet is heated, and then extruded through a die with the desired shape. This process crystallizes the weaker cast material into the stronger, extruded structure of the shaped die.

Cold Draw

The hot, extruded stock is then pulled through a secondary, smaller die of the same shape. This further recrystallizes and refines the material while increasing elongation and strength.

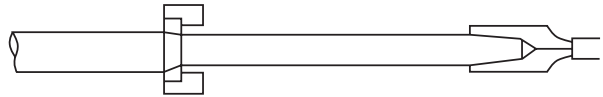
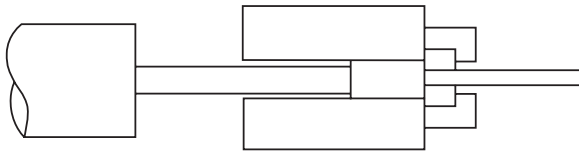

Die Shapes

Billet dies come in literally hundreds of shapes. Four of the most common are shown below:



Precision Machined

Cold bar stock is cut into individual pieces of varying sizes and lengths, then precision machined into solid, one-piece, high-quality parts offering up to 10-times the strength of competitive cast or forged fittings.



Microstructure

The Gates manufacturing process starts out by transforming the low-strength, low-ductile cast billet into the stronger, crystallized structure of the hot, extruded stock. Next, this extruded material is further refined into the ultra-strong, cold-drawn bar stock which is then cut and precision-machined on state-of-the-art CNC equipment.

Coupling Visual Index

Air Brake Copper Tubing Compression - D.O.T.
Air Brake SureLok™ - D.O.T.
Composite Air Brake SureLok™ - D.O.T.
Air Brake Compression Fittings - D.O.T.
Air Brake Couplings for Rubber Hose
Valves
Brass Lock-On Field Attachable Couplings for LOC & LOL Hose
Single Bead
Barb Stem
Inverted Flare
Automotive Adapters
Copper Tubing Industrial Compression
Industrial SureLok™
Mini-Barbed Tube
Poly Industrial Compression
Pipe Adapters
Adapters SAE Flare
Threaded Sleeve

AIR BRAKE NYLON TUBING
AIR BRAKE COPPER TUBING
AIR BRAKE SURELOK
COMPOSITE AIR BRAKE SURELOK
AIR BRAKE COMPRESSION FITTINGS
AIR BRAKE COUPLINGS FOR RUBBER HOSE
VALVES
BRASS LOCK-ON FIELD ATTACHABLE COUPLINGS
SINGLE BEAD
BARB STEM
INVERTED FLARE
AUTOMOTIVE ADAPTERS
COPPER TUBING INDUSTRIAL COMPRESSION
INDUSTRIAL SURELOK
MINI-BARBED TUBE
POLY INDUSTRIAL COMPRESSION
PIPE ADAPTERS
ADAPTERS SAE FLARE
THREADED SLEEVE
KITS & ASSORTMENTS

Coupling Visual Index

Air Brake Copper Tubing Compression - D.O.T.

Tube Sleeve G30050	Tube Sleeve Nut G30060	Air Brake to Male Pipe G30100	Air Brake to Male Pipe - 45° G30102	Air Brake to Male Pipe - 90° G30104	Air Brake to Male Pipe - 90° - Long G30106	Air Brake Run Tee to Male Pipe G30130	Air Brake Branch Tee to Male Pipe G30135
Air Brake to Female Pipe G30150	Air Brake to Female Pipe - 90° G30154	Air Brake Union G30400	Air Brake Union - 90° G30404	Air Brake Union - Tee G30450			

Air Brake SureLok™ - D.O.T.

Air Brake Plugs G31050	Air Brake Cartridge G31080	Air Brake to Male Pipe G31100	Air Brake to Male Pipe - 45° G31102	Air Brake to Male Pipe - 90° G31104	Air Brake to Male Pipe - 90° with Port G31105	Air Brake to Male Pipe Swivel - 45° G31122	Air Brake to Male Pipe Swivel - 90° G31124
Air Brake Run Tee to Male Pipe G31130, G31131, G31132	Air Brake Branch Tee to Male Pipe G31134, G31135, G31136	Air Brake Branch Y to Male Pipe - 90° G31138	Air Brake Run Tee to Male Pipe Swivel G31140	Air Brake Branch Tee to Male Pipe Swivel G31142	Air Brake to Female Pipe G31150	Air Brake to Female Pipe - 90° G31154	Air Brake Branch Tee to Female Pipe with Mounting Hole G31160
Air Brake to Male Pipe to Female Pipe Split Run Tee - Block Style G31167	Air Brake to Male Pipe to Female Pipe Split Run Tee G31168	Air Brake Bulkhead Union G31300	Air Brake to Female Pipe Bulkhead G31360	Air Brake Union G31400	Air Brake Union - 90° G31404	Air Brake Union - Tee G31450, G31451, G31452	Air Brake Union - Tee with Mounting Hole G31453

Composite Air Brake SureLok™ - D.O.T.





6-Port Manifold G31970	Air Brake Union Y G56975	Air Brake Run Y to Male Pipe G56978
---------------------------	-----------------------------	--

Air Brake Compression Fittings - D.O.T.



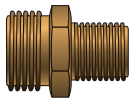
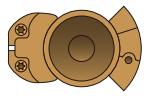

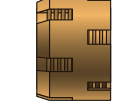
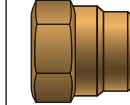
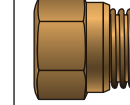
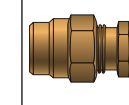
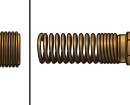
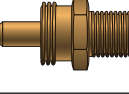
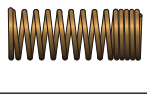
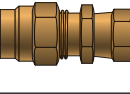

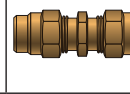



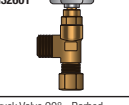

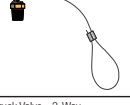
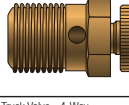
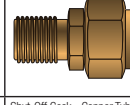

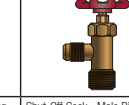
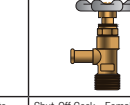





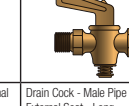
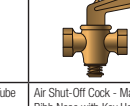
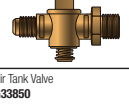
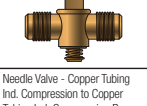
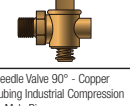
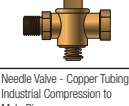
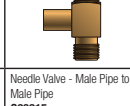
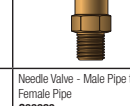
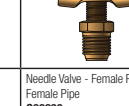
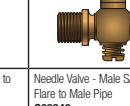
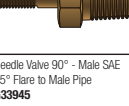
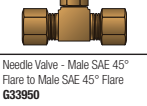









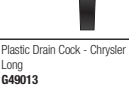



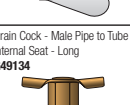

Tube Support Insert G32040	Tube Sleeve G32050	Tube Sleeve Nut G32060	Air Brake to Male Pipe G32100	Air Brake to Male Pipe - 45° G32102	Air Brake to Male Pipe - 90° G32104	Air Brake to Male Pipe - 90° - Long G32106	Air Brake Run Tee to Male Pipe G32130, G32131
Air Brake Branch Tee to Male Pipe G32134, G32136	Air Brake to Female Pipe G32150	Air Brake to Female Pipe - 90° G32154	Air Brake Branch Tee to Female Pipe G32160	Air Brake Bulkhead Union G32300	Air Brake Union G32400	Air Brake Union - 90° G32404	Air Brake Union - Tee G32450, G32452

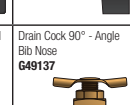
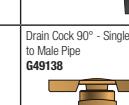
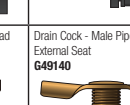
Coupling Visual Index

Air Brake Couplings for Rubber Hose

Male Air Brake to Male Pipe Adapter G33030 	Gladhand G33031 	Gladhand Seal G33032 	Sleeve G33050 	Nut G33060 	Spring Guard Nut G33061 	Air Brake to Male Pipe with Nut and Sleeve G33100 	Air Brake to Male Pipe with Spring Guard G33110 
Air Brake to Male Pipe without Nut and Sleeve G33111 	Air Brake Spring Guard G33112 	Air Brake to Female Air Brake Swivel G33150 	Air Brake to Female Air Brake Swivel with Adapter G33151 	Air Brake Union G33400 			

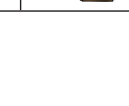
Valves

Truck Valve 90° - Air Brake Nylon Compression to Male Pipe Branch G32601 	Truck Valve 90° - Air Brake Nylon Compression to Male Pipe Run G32602 	Air Tank Drain Valve G33021 	Air Vent G33022 	One Way Check Valve G33027 	Truck Valve 90° - Male SAE 45° Flare to Male Pipe Run G33610 	Truck Valve 90° - Male SAE 45° to Male Pipe Branch G33612 	Truck Valve 90° - Single Bead to Male Pipe Run G33620 
Truck Valve 90° - Barbed to Male Pipe Branch with Pin Handle G33622 	Truck Valve 90° - Male Pipe to Female Pipe Branch G33630 	Truck Valve - 3-Way G33650 	Truck Valve - 4-Way G33655, G33656 	Shut-Off Cock - Copper Tubing Industrial Compression to Copper Tubing Industrial Compression Run G33701 	Shut-Off Cock - Copper Tubing Industrial Compression to Male Pipe Run G33705 	Shut-Off Cock - Male Pipe to Female Pipe Run G33710 	Shut-Off Cock - Female Pipe to Female Pipe Run G33715 
Shut-Off Cock - Male SAE 45° Flare to Male Pipe Run G33720 	Shut-Off Cock - Male SAE 45° Flare to Male SAE 45° Flare Run G33730 	Air Shut-Off Cock - Male Pipe to Bibb Nose G33801 	Air Drain Cock - Male Pipe to Female Pipe G33805 	Drain Cock 90° - Single Bead to Male Pipe - Long G33823 	Drain Cock - Male Pipe Internal Seat - Bibb Nose - Long G33830 	Drain Cock - Male Pipe to Tube External Seat - Long G33831 	Air Shut-Off Cock - Male Pipe - Bibb Nose with Key Handle G33832 
Air Tank Valve G33850 	Needle Valve - Copper Tubing Ind. Compression to Copper Tubing Ind. Compression Run G33901 	Needle Valve 90° - Copper Tubing Industrial Compression to Male Pipe G33905 	Needle Valve - Copper Tubing Industrial Compression to Male Pipe G33910 	Needle Valve - Male Pipe to Male Pipe G33915 	Needle Valve - Male Pipe to Female Pipe G33920 	Needle Valve - Female Pipe to Female Pipe G33930 	Needle Valve - Male SAE 45° Flare to Male Pipe G33940 
Needle Valve 90° - Male SAE 45° Flare to Male Pipe G33945 	Needle Valve - Male SAE 45° Flare to Male SAE 45° Flare G33950 	Plastic Drain Cock - Chrysler Black Key Style G49001 	Plastic Drain Cock - General Motors G49002 	Plastic Drain Cock - Ford (Short) 3 G49003 	Plastic Drain Cock - Ford (Long) 4 G49004 	Plastic Drain Cock - Metric Long Stem G49005, G49006, G49007 	Plastic Drain Cock - Metric Short Stem G49008 
Plastic Drain Cock - Metric G49009 	Plastic Drain Cock - Metric G49010 	Plastic Drain Cock - Metric Ford and Mazda G49011, G49012 	Plastic Drain Cock - Chrysler Long G49013 	Plastic Drain Cock - Metric Ford G49014 	Plastic Drain Cock - Chrysler Short G49015 	Plastic Drain Cock - Chrysler Wide Opening G49016 	Plastic Drain Cock - GM Black Key Style G49017 
Plastic Drain Cock - GM G49018 	Drain Cock - Male Pipe Internal Seat G49129, G49130 	Drain Cock - Male Pipe to Tube Internal Seat - Long G49134 	Drain Cock - Male Pipe to Tube Internal Seat - Long Tube G49135 	Drain Cock - Male Pipe Internal Seat - Bibb Nose G49136 	Drain Cock 90° - Angle G49137 	Drain Cock 90° - Single Bead to Male Pipe G49138 	Drain Cock - Male Pipe External Seat G49140 
Gasoline Shut-Off with Screen Filter G49255 							

AIR BRAKE NYLON TUBING

AIR BRAKE COPPER TUBING

AIR BRAKE SURELOK

COMPOSITE AIR BRAKE SURELOK

AIR BRAKE COMPRESSION FITTINGS

AIR BRAKE COUPLINGS FOR RUBBER HOSE

VALVES

BRASS LOCK-ON FIELD ATTACHABLE COUPLINGS

SINGLE BEAD

BARB STEM

INVERTED FLARE

AUTOMOTIVE ADAPTERS

COPPER TUBING INDUSTRIAL COMPRESSION

INDUSTRIAL SURELOK

MINI-BARBED TUBE

POLY INDUSTRIAL COMPRESSION

PIPE ADAPTERS

ADAPTERS SAE FLARE







THREADED SLEEVE

KITS & ASSORTMENTS

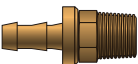
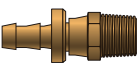
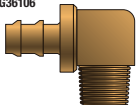
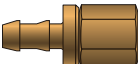
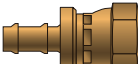
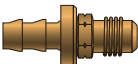

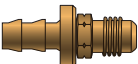
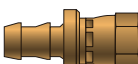
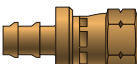
Coupling Visual Index

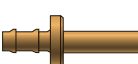
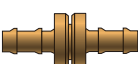
AIR BRAKE NYLON TUBING
AIR BRAKE COPPER TUBING
AIR BRAKE SURELOK
COMPOSITE AIR BRAKE SURELOK
AIR BRAKE COMPRESSION FITTINGS
AIR BRAKE COUPLINGS FOR RUBBER HOSE
VALVES
BRASS LOCK-ON FIELD ATTACHABLE COUPLINGS
SINGLE BEAD
BARB STEM
INVERTED FLARE
AUTOMOTIVE ADAPTERS
COPPER TUBING INDUSTRIAL COMPRESSION
INDUSTRIAL SURELOK
MINI-BARBED TUBE
POLY INDUSTRIAL COMPRESSION
PIPE ADAPTERS
ADAPTERS SAE FLARE
THREADED SLEEVE
KITS & ASSORTMENTS

Brass Lock-On Field Attachable Couplings for LOC & LOL Hose

Male Pipe with Cone Seat G36100 	Male Pipe Swivel without Cone Seat G36105 	Male Pipe 90° Block with Cone Seat G36106 	Female Pipe without Cone Seat G36110 	Female Pipe Swivel with Cone Seat G36111 	Male JIC 37° Flare G36165 	Female JIC 37° Flare Swivel G36170 	Male SAE 45° Flare G36195 
Female SAE 45° Flare Swivel G36200 	Dual Seat Female JIC 37°/SAE 45° Flare Swivel G36210 	Male SAE Inverted Flare Swivel G36500 	Female SAE Inverted Flare G36508 	North American Stand Pipe G36520 	Hose Length Extenders G36535 	Male British Standard Pipe Tapered G36795 	

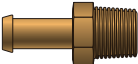
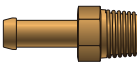
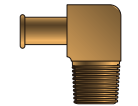
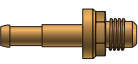
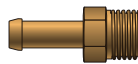
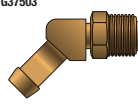
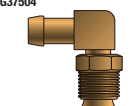





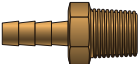
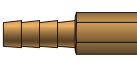

Single Bead

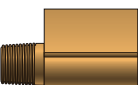
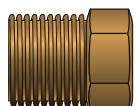
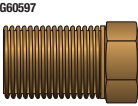
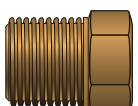
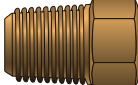
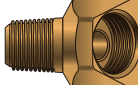
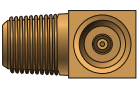
Male Pipe with Cone Seat G37100 	Male Straight Thread Connector G37103 	Male Pipe 90° Block Cone Seat 37106 	Male SAE 45° Flare Connector G37195 	Male SAE Inverted Flare G37500 	Male SAE Inverted Flare Swivel - 45° G37503 	Male SAE Inverted Flare Swivel - 90° G37504 	Female SAE Inverted Flare G37508 
--	--	--	--	---	---	--	---

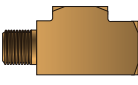
Barb Stem

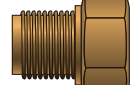
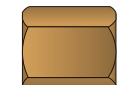



Male Pipe NPTF with Cone Seat G38100 	Female Pipe NPTF G38110 
---	--

Inverted Flare



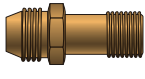
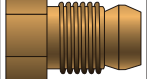
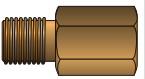
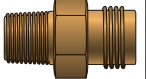
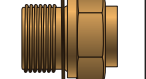
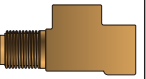
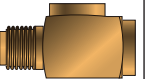
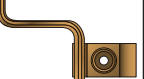

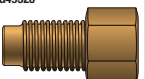
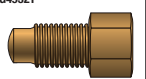
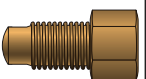
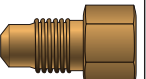
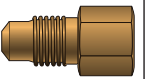
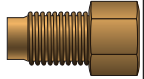
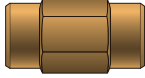
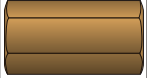
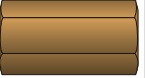
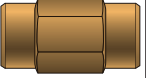
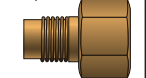
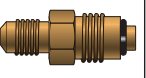
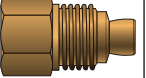
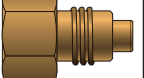

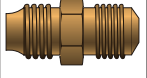
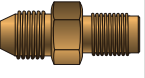
Male Pipe to Female Pipe to Female Inverted Split Run Tee G49375 	Male Inverted Tube Nut - Steel G60596 	Male Inverted Tube Nut - Steel - Long G60597 	Male Inverted Tube Nut - Brass G60599 	Female Inverted Flare to Male Pipe G60625 	Female Inverted Flare to Male Pipe - 45° G60626 	Female Inverted Flare to Male Pipe - 90° G60627 	Female Inverted Branch Tee to Male Pipe G60628 
Female Inverted Run Tee to Male Pipe G60629 	Female Inverted to Female Pipe G60630 	Male Inverted Flare Plug G60691 	Female Inverted to Female Inverted Union G60693 	Female Inverted to Female Inverted Union - 90° G60694 	Female Inverted Union - Tee G60695 	Female Inverted Branch Tee to Female Pipe G60696 	

Coupling Visual Index

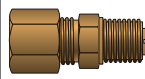
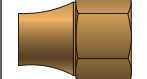

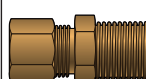
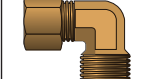
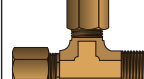
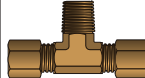
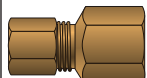
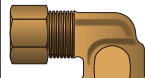

Automotive Adapters

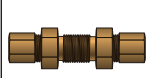
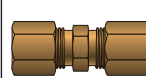
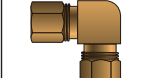
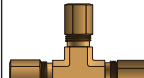
Turbo Charger Connector G49200 	Ford Nut G49230 	Carburetor to Fuel Line Adapter (Ford) G49240 	Fuel Line Adapter (Plymouth) G49250 	Carburetor Inlet - Steel G49251 	Towed Trailer Brake - Tee G49300, G49301, G49302, G49303 	Metric Towed Trailer Brake - Tee G49304, G49305 	Hydraulic Brake Strap Assembly - Tee G49310, G49312 
Hydraulic Brake - Block G49313 	Hydraulic Brake with Bolt Hole - Tee G49314 	Metric Hydraulic Brake Adapter - Male Inverted to Tube O.D. Female G49320 	Metric Hydraulic Brake Adapter - Male Bubble to Tube O.D. Female G49321 	Metric Hydraulic Brake Adapter - Bubble G49323 	Metric Hydraulic Brake Adapter - British Bubble G49324 	Standard to Metric G49325 	Adapter Standard to Metric Bubble G49326 
Hydraulic Brake Metric Union G49400 	Hydraulic Brake Union - British G49401 	Hydraulic Brake Union - European G49402 	Hydraulic Brake Union - Japanese G49403 	Dual Master Cylinder Adapter G49500, G49501, G49502, G49503, G49504, G49505, G49506, G49507 	JIC 37° Flare Power Steering Adapter G49700 	Ford Power Steering Adapter G49701 	Metric Power Steering Adapter G49702 
Transmission Oil Cooler Line Adapter G49800 	Air Conditioning Adapter G49900 	Male SAE 45° - Male Inverted G49901, G60679 					

Copper Tubing Industrial Compression

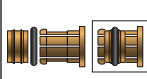
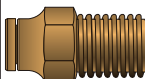
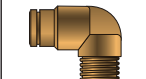
Copper Tubing Industrial to Male Pipe - Check Valve G55028 	Nut - Long G55030 	Tube Sleeve Insert G55040 	Tube Sleeve G55050 	Tube Sleeve Nut G55060 	Copper Tubing Industrial to Male Pipe G55100 	Copper Tubing Industrial to Male Pipe - 90° G55104 	Copper Tubing Industrial Run Tee to Male Pipe G55130 
Copper Tubing Industrial Branch Tee to Male Pipe G55134 	Copper Tubing Industrial to Female Pipe G55150 	Copper Tubing Industrial to Female Pipe - 90° G55154 	Copper Tubing Industrial to Male Pipe to Female Pipe Run Tee G55161 	Copper Tubing Industrial Bulkhead Union G55300 	Copper Tubing Industrial Union G55400 	Copper Tubing Industrial Union - 90° G55404 	Copper Tubing Industrial Union Tee G55450 

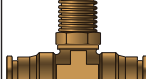
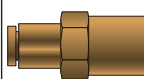
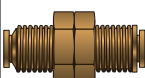
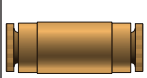
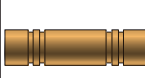
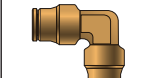
Industrial SureLok™

Industrial SureLok Plug G56050 	Industrial SureLok Cartridge G56099 	Industrial SureLok to Male Pipe G56100 	Industrial SureLok to Male Pipe - 90° G56104 	Industrial SureLok to Male Pipe Swivel - 90° G56124 	Industrial SureLok Run Tee to Male Pipe Swivel G56140 	Industrial SureLok Branch Tee to Male Pipe Swivel G56142 	Industrial SureLok to Female Pipe G56150 
Industrial SureLok Bulkhead Union G56300 	Industrial SureLok Union G56400 	Industrial SureLok Double Union G56402 	Industrial SureLok Union - 90° G56404 	Industrial SureLok Union - Tee G56450 			

AIR BRAKE
NYLON TUBING

AIR BRAKE
COPPER TUBING

AIR BRAKE
SURELOK

COMPOSITE AIR
BRAKE SURELOK

AIR BRAKE
COMPRESSION
FITTINGS

AIR BRAKE
COUPLINGS FOR
RUBBER HOSE

VALVES

BRASS LOCK-ON
FIELD
ATTACHABLE
COUPLINGS

SINGLE BEAD

BARB STEM

INVERTED FLARE

AUTOMOTIVE
ADAPTERS

COPPER TUBING
INDUSTRIAL
COMPRESSION

INDUSTRIAL
SURELOK

MINI-BARBED
TUBE

POLY
INDUSTRIAL
COMPRESSION

PIPE ADAPTERS

ADAPTERS SAE
FLARE





THREADED
SLEEVE

KITS &
ASSORTMENTS

Coupling Visual Index

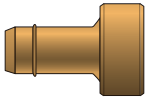
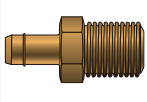
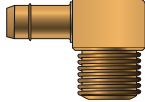
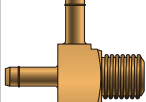
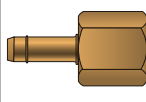
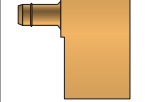
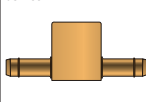
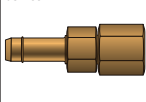
AIR BRAKE NYLON TUBING
AIR BRAKE COPPER TUBING
AIR BRAKE SURELOK
COMPOSITE AIR BRAKE SURELOK
AIR BRAKE COMPRESSION FITTINGS
AIR BRAKE COUPLINGS FOR RUBBER HOSE
VALVES
BRASS LOCK-ON FIELD ATTACHABLE COUPLINGS
SINGLE BEAD
BARB STEM
INVERTED FLARE
AUTOMOTIVE ADAPTERS
COPPER TUBING INDUSTRIAL COMPRESSION
INDUSTRIAL SURELOK
MINI-BARBED TUBE
POLY INDUSTRIAL COMPRESSION
PIPE ADAPTERS
ADAPTERS SAE FLARE
THREADED SLEEVE
KITS & ASSORTMENTS

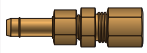
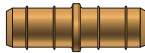
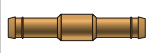

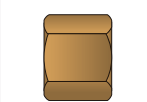
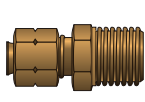
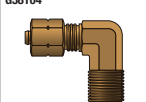
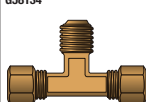
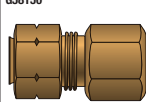
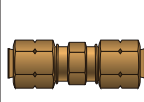

Mini-Barbed Tube

Plug G57050 	Mini-Barb to Male Pipe G57100 	Mini-Barb to Male Pipe - 90° G57104 	Mini-Barb Run Tee to Male Pipe G57130 	Mini-Barb to Female Pipe G57150 	Mini-Barb to Female Pipe - 90° G57154 	Mini-Barb Branch Tee to Female Pipe G57160 	Mini-Barb to Industrial Copper Tubing Compression G57190 
Mini-Barb Bulkhead Union G57300 	Mini-Barb to Copper Tubing Industrial Compression Assembly Bulkhead G57350 	Mini-Barb Union G57400 	Mini-Barb Union - Long G57401 	Mini-Barb Union - 90° G57404 	Mini-Barb Union - Tee G57452 		

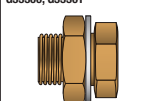
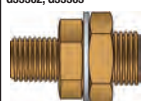
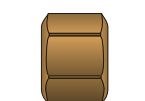
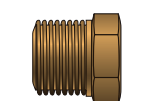
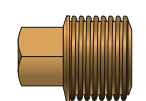
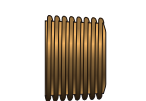
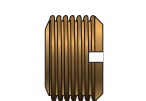
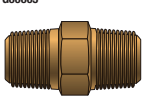
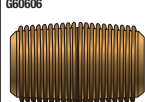
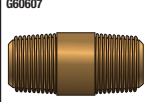
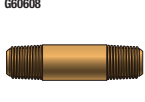
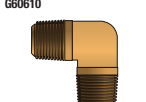
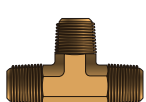
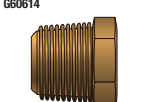
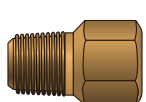
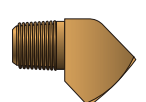
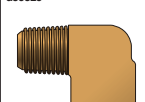

Poly Industrial Compression

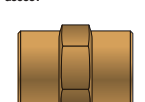
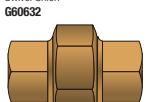
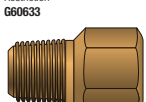
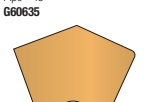
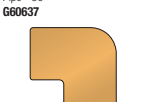
Tubing Sleeve G58050 	Tubing Sleeve Nut G58060 	Compression PVC to Male Pipe G58100 	Compression PVC to Male Pipe - 90° G58104 	Compression PVC Branch Tee to Male Pipe G58134 	Compression PVC to Female Pipe G58150 	Compression PVC Union G58400 
--	--	---	---	--	--	--

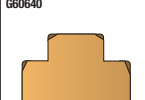
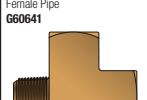
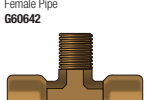
Pipe Adapters

Female Pipe to Female Pipe Bulkhead G33300, G33301 	Male Pipe to Female Pipe Bulkhead G33302, G33303 	Female Pipe Cap G60600 	Male Pipe Plug - Hex Head G60601 	Male Pipe Plug - Square Head G60602 	Male Pipe Plug - Hex Key Head G60603 	Male Pipe Plug - Slotted Head G60604 	Male Pipe to Male Pipe Hex Nipple G60605 
Male Pipe to Male Pipe Close Nipple G60606 	Male Pipe to Male Pipe Medium Nipple G60607 	Male Pipe to Male Pipe Long Nipple G60608 	Male Pipe NPTF to Male Pipe NPTF - 90° G60610 	Male Pipe NPTF Union - Tee G60612 	Male Pipe to Female Pipe - Reducer G60614 	Male Pipe to Female Pipe - Long G60615 	Male Pipe to Female Pipe - 45° G60618 
Male Pipe to Female Pipe - 90° G60620 	Male Pipe to Female Pipe to Male SAE 45° Flare - Split Run Tee G60623 	Female Pipe to Female Pipe G60631 	Female Pipe to Female Pipe Swivel Union G60632 	Male Pipe to Female Pipe - Restriction G60633 	Female Pipe to Female Pipe - 45° G60635 	Female Pipe to Female Pipe - 90° G60637 	Female Pipe - Cross G60639 
Female Pipe - Union Tee G60640 	Male Pipe Run Tee to Female Pipe G60641 	Male Pipe Branch Tee to Female Pipe G60642 					

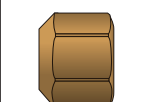
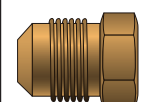
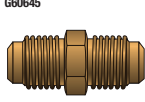
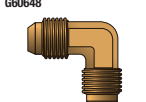
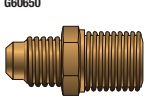
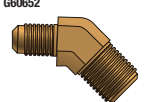
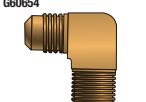
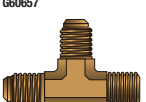
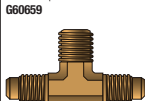
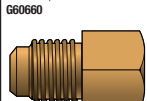
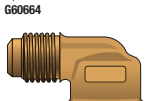
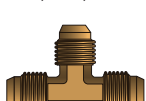
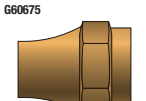
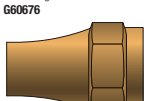
Adapters SAE Flare

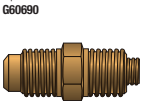
Female SAE 45° Flare Cap G60643 	Male SAE Plug G60644 	Male SAE 45° Flare to Male SAE 45° Flare G60645 	Male SAE 45° Flare to Male SAE 45° Flare - 90° G60648 	Male SAE 45° Flare to Male Pipe G60650 	Male SAE 45° Flare to Male Pipe - 45° G60652 	Male SAE 45° Flare to Male Pipe - 90° G60654 	Male SAE 45° Flare Run Tee to Male Pipe G60657 
Male SAE 45° Flare Branch Tee to Male Pipe G60659 	Male SAE 45° Flare to Female Pipe G60660 	Male SAE 45° Flare to Female Pipe - 90° G60664 	SAE 45° Flare Union Tee Brass G60669, G60670, G60671 	Female SAE 45° Flare Nut - Short G60675 	Female SAE 45° Flare Nut - Long G60676 	Male SAE 45° Flare - Cross G60680 	Male SAE 45° Flare to Male Pipe - Check Valve G60690 

Coupling Visual Index

Threaded Sleeve

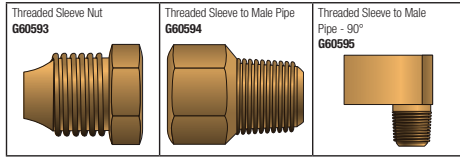

AIR BRAKE NYLON TUBING
AIR BRAKE COPPER TUBING
AIR BRAKE SURELOK
COMPOSITE AIR BRAKE SURELOK
AIR BRAKE COMPRESSION FITTINGS
AIR BRAKE COUPLINGS FOR RUBBER HOSE
VALVES
BRASS LOCK-ON FIELD ATTACHABLE COUPLINGS
SINGLE BEAD
BARB STEM
INVERTED FLARE
AUTOMOTIVE ADAPTERS
COPPER TUBING INDUSTRIAL COMPRESSION
INDUSTRIAL SURELOK
MINI-BARBED TUBE
POLY INDUSTRIAL COMPRESSION
PIPE ADAPTERS
ADAPTERS SAE FLARE
THREADED SLEEVE
KITS & ASSORTMENTS

Thread ID Chart

DASH SIZE	2	3	4	5	6	7	8	10	12	14	16	20	24	32	40	48
	1/8	3/16	1/4	5/16	3/8	7/16	1/2	5/8	3/4	7/8	1	1 1/4	1 1/2	2	2 1/2	3
NPTF Pipe Thread	1/8-27	1/4-18	3/8-18	1/2-14	5/8-14	3/4-14	7/8-14	1-11 1/2	1 1/8-11 1/2	1 1/4-11 1/2	1 1/2-11 1/2	1 5/8-11 1/2	2-11 1/2	2 1/8-11 1/2	2 1/2-8	3-8
NPSM Swivel Thread	1/8-27	1/4-18	3/8-18	1/2-14	5/8-14	3/4-14	7/8-14	1-11 1/2	1 1/8-11 1/2	1 1/4-11 1/2	1 1/2-11 1/2	1 5/8-11 1/2	2-11 1/2	2 1/8-11 1/2	2 1/2-8	3-8
JIC 37° Flare Thread	3/8-24	1/2-20	5/8-18	3/4-16	7/8-14	1 1/8-12	1 1/4-12	1 1/2-12	1 5/8-12	2-12	2 1/8-12	2 1/4-12	2 3/8-12	3-12	3 1/2-12	
SAE 45° Flare Thread	3/8-24	1/2-20	5/8-18	3/4-16	7/8-14	1 1/8-12	1 1/4-12	1 1/2-12	1 5/8-12	2-12	2 1/8-12	2 1/4-12	2 3/8-12	3-12	3 1/2-12	
SAE O-Ring Thread	3/8-24	1/2-20	5/8-18	3/4-16	7/8-14	1 1/8-12	1 1/4-12	1 1/2-12	1 5/8-12	2-12	2 1/8-12	2 1/4-12	2 3/8-12	3-12	3 1/2-12	
Flat-Face Thread	9/16-18	5/8-16	3/4-16	7/8-14	1 1/8-12	1 1/4-12	1 1/2-12	1 5/8-12	2-12	2 1/8-12	2 1/4-12	2 3/8-12	3-12	3 1/2-12		
Inverted Flare Thread	9/16-18	5/8-16	3/4-16	7/8-14	1 1/8-12	1 1/4-12	1 1/2-12	1 5/8-12	2-12	2 1/8-12	2 1/4-12	2 3/8-12	3-12	3 1/2-12		
Compression Thread	9/16-24	5/8-24	3/4-24	7/8-24	1 1/8-24	1 1/4-24	1 1/2-24	1 5/8-24	2-24	2 1/8-24	2 1/4-24	2 3/8-24	3-24	3 1/2-24		
Code 61 Flange Head O.D.																
Code 62 Flange Head O.D.																
Code 62 Flange Head O.D.																
BSP Thread	1/8-28	1/4-19	3/8-19	1/2-14	5/8-14	3/4-14	7/8-14	1-11 1/2	1 1/8-11 1/2	1 1/4-11 1/2	1 1/2-11 1/2	1 5/8-11 1/2	2-11 1/2	2 1/8-11 1/2	2 1/2-8	3-8
BSP Thread	1/8-28	1/4-19	3/8-19	1/2-14	5/8-14	3/4-14	7/8-14	1-11 1/2	1 1/8-11 1/2	1 1/4-11 1/2	1 1/2-11 1/2	1 5/8-11 1/2	2-11 1/2	2 1/8-11 1/2	2 1/2-8	3-8
Japanese Pipe Tapered Thread	1/8-28	1/4-19	3/8-19	1/2-14	5/8-14	3/4-14	7/8-14	1-11 1/2	1 1/8-11 1/2	1 1/4-11 1/2	1 1/2-11 1/2	1 5/8-11 1/2	2-11 1/2	2 1/8-11 1/2	2 1/2-8	3-8
Japanese Flare Thread	1/8-28	1/4-19	3/8-19	1/2-14	5/8-14	3/4-14	7/8-14	1-11 1/2	1 1/8-11 1/2	1 1/4-11 1/2	1 1/2-11 1/2	1 5/8-11 1/2	2-11 1/2	2 1/8-11 1/2	2 1/2-8	3-8
Copper/Nylon Air Brake Thread	7/16-24	1 1/8-20	1 1/4-18	1 1/2-18	1 3/4-18	2-18	2 1/4-18	2 3/8-18	3-18	3 1/2-18	4-18	4 1/2-18	5-18	5 1/2-18	6-18	6 1/2-18

AIR BRAKE NYLON TUBING
AIR BRAKE COPPER TUBING
AIR BRAKE SURELOK
COMPOSITE AIR BRAKE SURELOK
AIR BRAKE COMPRESSION FITTINGS
AIR BRAKE COUPLINGS FOR RUBBER HOSE
VALVES
BRASS LOCK-ON FIELD ATTACHABLE COUPLINGS
SINGLE BEAD
BARB STEM
INVERTED FLARE
AUTOMOTIVE ADAPTERS
COPPER TUBING INDUSTRIAL COMPRESSION
INDUSTRIAL SURELOK
MINI-BARBED TUBE
POLY INDUSTRIAL COMPRESSION
PIPE ADAPTERS
ADAPTERS SAE FLARE
THREADED SLEEVE
KITS & ASSORTMENTS

Getting the Best Service Life

How long will an air brake assembly last? It depends on how it's used. This catalog and other literature show the recommended limits for Gates assemblies (and also the tubing and fittings used to make the assemblies). These limits include installation, maintenance and conditions of use. These limits **MUST** be followed or the assembly may fail prematurely, possibly resulting in injury or damage. If you do not have this important information, you can get it at no cost from your local Gates distributor or Gates field representative. Tubing and assemblies in use should be inspected regularly for leaks, kinks, cover blisters, gouges, abrasion and other damage. Damaged or worn assemblies must be replaced immediately. You can maximize tubing assembly life if you observe the following:

CAUTION!

Minimum Burst Pressure – Burst pressures are intended for destructive testing purposes of samples and for design safety factors only. Burst pressures are for reference only and do not represent performance in use.

Temperature Range – Do not expose tubing to internal or external temperatures exceeding the recommended limits of -40°F to +200°F (-40°C to +93°C). Keep tubing away from external heat sources like exhaust manifolds or other hot under-the-hood locations. Actual service life at temperatures approaching the recommended limit will depend on the particular application and the fluid being conveyed by the hose. Intermittent (up to 10% operating time) refers to momentary temperatures surges. Detrimental effects increase with prolonged exposure to elevated temperatures.

Minimum Bend Radius – Do not bend or flex tubing to a radius smaller than the minimum recommended, and do not subject tubing to tension or torque. This can place excessive stress on the reinforcement and severely reduce the ability of the tubing to withstand pressure.

SAFETY CONCERNS

1. **Receive hands-on training** with Gates recommended hose assembly equipment and procedures.
2. **Follow the vehicle manufacturer's service recommendations.**
3. **Use only new (unused)** Gates recommended tubing and fittings, and follow Gates recommended assembly procedures.
4. **Use only Gates certified tubing and fittings.** Gates nylon air brake tubing conforms to SAE J844 and DOT FMVSS106.
5. **Tubing must not be stretched, kinked, crushed or twisted** during installation and use. Tubing **must not** be bent to less than the rated minimum bend radius. Replace damaged tubing immediately.

Assembly Routing – Restrain, protect or guide tubing with clamps, if necessary, to minimize the risk of damage due to excessive flexing, whipping or contacting other moving parts or surfaces. Determine proper tubing lengths and configurations that protect against abrasion, snagging or kinking, and provide leak-resistant connections.

Assembly Length – Correct tubing length should include considerations for length changes under pressure, machine vibration and motion, and assembly routing.

Tubing Shelf Life – Storage environment and materials can vary the shelf life limit. Shelf life is difficult to quantify as many variables can adversely affect tubing. Proper storage precautions can result in three to five years shelf life. Beyond this time there can be a significant reduction in service life, depending on storage environment variables. Some variables include:

- Storage in a cool, dry area never exceeding +100°F (+38°C). If stored below freezing, pre-warming may be required prior to handling, testing and placing into service.
- Direct sunlight, heaters or being near electrical equipment
- Humidity and ozone
- Oil, solvents, corrosive materials or fumes
- Insects or rodents
- Radioactivity
- Space allowance and bends

Gates recommends visually inspecting and testing tubing in extended storage prior to use. Tubing judged marginal should be replaced to avoid potential failure, property damage or bodily injury. Always stock tubing on a first-in/first-out basis. Unusually long or poor storage environment can deteriorate tubing, reduce performance and may lead to premature failure.

6. Many factors affect the assembly, installation and service of air brake assemblies. This catalog and Gates Corporation have useful information about making, installing and servicing air brake assemblies. For further assistance, contact your local Gates representative or contact Gates Corporation at 1-303-744-5070.
7. **Gates disclaims** all liability for any air brake assembly made or used in violation of Gates recommendations and procedures. The consumer's exclusive remedy with respect to any claim shall be a refund of the purchase price or replacement of the product at the option of Gates. In no event shall Gates be liable for any incidental or consequential damages whatsoever.
8. These products must not be used in aircraft, for racing or other competitive events.

AIR BRAKE NYLON TUBING
AIR BRAKE COPPER TUBING
AIR BRAKE SURELOK
COMPOSITE AIR BRAKE SURELOK
AIR BRAKE COMPRESSION FITTINGS
AIR BRAKE COUPLINGS FOR RUBBER HOSE
VALVES
BRASS LOCK-ON FIELD ATTACHABLE COUPLINGS
SINGLE BEAD
BARB STEM
INVERTED FLARE
AUTOMOTIVE ADAPTERS
COPPER TUBING INDUSTRIAL COMPRESSION
INDUSTRIAL SURELOK
MINI-BARBED TUBE
POLY INDUSTRIAL COMPRESSION
PIPE ADAPTERS
ADAPTERS SAE FLARE
THREADED SLEEVE
KITS & ASSORTMENTS

Gates Global Part Numbering System

Gates couplings feature a meaningful part number that makes coupling identification fast and easy. In the following example, the global part number G31100-0808 identifies a SureLok™ Male Pipe (MP) coupling with -8 (1/2") tube size and -8 (1/2") thread size.

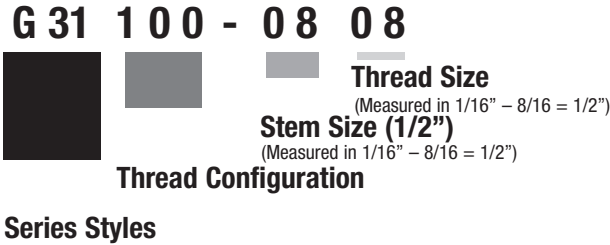

Series Styles:

Air Brake

G30—Copper Tubing
G31—SureLok™ Fittings
G32—Compression Fittings
G33—Air Brake Fittings for Rubber Hose

G49—Automotive Adapters
G55—Copper Tubing Industrial
G56—SureLok™ Industrial
G57—Mini-Barb
G58—Compression PVC

Adapters

G60—Brass Adapters

Brass Stemed Fittings

G36—Brass Lock-On Field Attachable
G37—Single Bead
G38—Barb Stem

Thread Configurations

These three-digit numbers identify the various coupling thread configurations

Air Brake – G30

050 — TS-ABCT	Tube Sleeve	135 — ABCT-ABCT-MP	Air Brake Branch Tee to Male Pipe
060 — TSN-ABCT	Tube Sleeve Nut	150 — ABCT-FP	Air Brake to Female Pipe
100 — ABCT-MP	Air Brake to Male Pipe	154 — ABCT-FP90	Air Brake to Female Pipe - 90°
102 — ABCT-MP45	Air Brake to Male Pipe - 45°	400 — ABCT-ABCT	Air Brake Union
104 — ABCT-MP90	Air Brake to Male Pipe - 90°	404 — ABCT-ABCT90	Air Brake Union - 90°
106 — ABCT-MP90L	Air Brake to Male Pipe - 90° - Long	450 — ABCT-ABCT-ABCT	Air Brake Union - Tee
130 — MP-ABCT-ABCT	Air Brake Run Tee to Male Pipe		

Air Brake – G31

050 — AB-PLUG	Air Brake Plugs	140 — MPX-AB-AB	Air Brake Run Tee to Male Pipe Swivel
080 — CARTRIDGE-AB	Air Brake Cartridge	142 — AB-AB-MPX	Air Brake Branch Tee to Male Pipe Swivel
100 — AB-MP	Air Brake to Male Pipe	150 — AB-FP	Air Brake to Female Pipe
102 — AB-MP45	Air Brake to Male Pipe - 45°	154 — AB-FP90	Air Brake to Female Pipe - 90°
104 — AB-MP90	Air Brake to Male Pipe - 90°	160 — AB-AB-FP	Air Brake Branch Tee to Female Pipe with Mounting Hole
105 — AB-MP-PT90	Air Brake to Male Pipe - 90° with Port		
122 — AB-MPX45	Air Brake to Male Pipe Swivel - 45°	167 — MP-AB-FP	Air Brake to Male Pipe to Female Pipe Split Run Tee - Block Style
124 — AB-MPX90	Air Brake to Male Pipe Swivel - 90°	168 — AB-MP-FP	Air Brake to Male Pipe to Female Pipe Split Run Tee
130 — MP-AB-AB	Air Brake Run Tee to Male Pipe	300 — AB-AB-BKHD	Air Brake Bulkhead Union
131 — MP-AB-AB	Air Brake Run Tee to Male Pipe	360 — AB-FP-BKHD	Air Brake to Female Pipe Bulkhead
132 — MP-AB-AB	Air Brake Run Tee to Male Pipe	400 — AB-AB	Air Brake Union
134 — AB-AB-MP	Air Brake Branch Tee to Male Pipe	404 — AB-AB90	Air Brake Union - 90°
135 — AB-AB-MP	Air Brake Branch Tee to Male Pipe	450 — AB-AB-AB	Air Brake Union - Tee
136 — AB-AB-MP	Air Brake Branch Tee to Male Pipe		
138 — AB-AB-MP90	Air Brake Branch Y to Male Pipe - 90°		

Gates Global Part Numbering System

Thread Configurations — continued

Air Brake – G31 — continued

451 — AB-AB-AB	Air Brake Union - Tee	453 — AB-AB-AB-MH	Air Brake Union - Tee with Mounting Hole
452 — AB-AB-AB	Air Brake Union - Tee	970 — AB-MANIFOLD	6-Port Manifold

Air Brake – G32

040 — TSI-ABC	Tube Support Insert	150 — ABC-FP	Air Brake to Female Pipe
040 — TSI-ABCB	Tube Support Insert	154 — ABC-FP90	Air Brake to Female Pipe - 90°
050 — TS-ABC	Tube Sleeve	160 — ABC-ABC-FP	Air Brake Branch Tee to Female Pipe
060 — TSN-ABC	Tube Sleeve Nut	300 — ABC-ABC-BKHD	Air Brake Bulkhead Union
100 — ABC-MP	Air Brake to Male Pipe	400 — ABC-ABC	Air Brake Union
102 — ABC-MP45	Air Brake to Male Pipe - 45°	404 — ABC-ABC90	Air Brake Union - 90°
104 — ABC-MP90	Air Brake to Male Pipe - 90°	450 — ABC-ABC-ABC	Air Brake Union - Tee
106 — ABC-MP90L	Air Brake to Male Pipe - 90° - Long	452 — ABC-ABC-ABC	Air Brake Union - Tee
130 — MP-ABC-ABC	Air Brake Run Tee to Male Pipe	601 — ABC-MP90-TV	Truck Valve 90° - Air Brake Nylon Compression to Male Pipe Branch
131 — MP-ABC-ABC	Air Brake Run Tee to Male Pipe	602 — MP-ABC90-TV	Truck Valve 90° - Air Brake Nylon Compression to Male Pipe Run
134 — ABC-ABC-MP	Air Brake Branch Tee to Male Pipe		
136 — ABC-ABC-MP	Air Brake Branch Tee to Male Pipe		

Air Brake – G33

021 — MP-ATDV	Air Tank Drain Valve	705 — MFA-MPSC	Shut-Off Cock - Copper Tubing Industrial Compression to Male Pipe Run
022 — MP-AV	Air Vent	710 — MP-FPSC	Shut-Off Cock - Male Pipe to Female Pipe Run
027 — MP-CV	One Way Check Valve	715 — FP-FPSC	Shut-Off Cock - Female Pipe to Female Pipe Run
030 — MAB-MP	Male Air Brake to Male Pipe Adapter	720 — MS-MPSC	Shut-Off Cock - Male SAE 45° Flare to Male Pipe Run
031 — GH	Gladhand	730 — MS-MSSC	Shut-Off Cock - Male SAE 45° Flare to Male SAE 45° Flare Run
032 — GH-SEAL	Gladhand Seal	801 — MP-ADC	Air Shut-Off Cock - Male Pipe to Bibb Nose
050 — TS-ABR	Sleeve	805 — FP-MPADC	Air Drain Cock - Male Pipe to Female Pipe
060 — TSN-ABR	Nut	823 — BN-MPDC90	Drain Cock 90° - Single Bead to Male Pipe - Long
061 — SGN-ABR	Spring Guard Nut	830 — MP-ISDC	Drain Cock - Male Pipe Internal Seat - Bibb Nose - Long
100 — ABR-MP	Air Brake to Male Pipe with Nut and Sleeve	831 — MP-ESDC	Drain Cock - Male Pipe to Tube External Seat - Long
110 — ABRSG-MP	Air Brake to Male Pipe with Spring Guard	832 — MP-ADCBN	Air Shut-off Cock - Male Pipe - Bibb Nose with Key Handle
111 — ABRI-MP	Air Brake to Male Pipe without Nut and Sleeve	850 — ATNKV	Air Tank Valve
112 — SGABR	Air Brake Spring Guard	901 — MFA-MFANV	Needle Valve - Copper Tubing Ind. Compression to Copper Tubing Ind. Compression Run
150 — ABR-FABX	Air Brake to Female Air Brake Swivel	905 — MFA-MP90NV	Needle Valve 90° - Copper Tubing Industrial Compression to Male Pipe
151 — ABR-FABX-MPA	Air Brake to Female Air Brake Swivel with Adapter	910 — MFA-MPNV	Needle Valve - Copper Tubing Industrial Compression to Male Pipe
300 — FP-FPBKHD	Female Pipe to Female Pipe Bulkhead	915 — MP-MPNV	Needle Valve - Male Pipe to Male Pipe
301 — FP-FPBKHDS	Female Pipe to Female Pipe Bulkhead	920 — MP-FPNV	Needle Valve - Male Pipe to Female Pipe
302 — MP-FPBKHDL	Male Pipe to Female Pipe Bulkhead	930 — FP-FPNV	Needle Valve - Female Pipe to Female Pipe
303 — MP-FPBKHD	Male Pipe to Female Pipe Bulkhead	940 — MS-MPNV	Needle Valve - Male SAE 45° Flare to Male Pipe
400 — ABR-ABR	Air Brake Union	945 — MS-MP90NV	Needle Valve 90° - Male SAE 45° Flare to Male Pipe
610 — MP-MS90-TV	Truck Valve 90° - Male SAE 45° Flare to Male Pipe Run	950 — MS-MSNV	Needle Valve - Male SAE 45° Flare to Male SAE 45° Flare
612 — MS-MP90-TV	Truck Valve 90° - Male SAE 45° to Male Pipe Branch		
620 — SB-MP90-TV	Truck Valve 90° - Single Bead to Male Pipe Run		
622 — SB-MP90-TVP	Truck Valve 90° - Barbed to Male Pipe Branch with Pin Handle		
630 — FP-MP90-TV	Truck Valve 90° - Male Pipe to Female Pipe Branch		
650 — FP-FP-FPWTV	Truck Valve - 3-Way		
655 — FP-FP-FPWTV	Truck Valve - 4-Way		
656 — FP-FP-FPWTV-L	Truck Valve - 4-Way		
701 — MFA-MFASC	Shut-Off Cock - Copper Tubing Ind. Compression to Copper Tubing Ind. Compression Run		

Air Brake – G49

240 — MPFLA-MI	Carburetor to Fuel Line Adapter (Ford)	900 — ACADAPTER-MS	Air Conditioning Adapter
321 — MMHBA-FMHBA	Metric Hydraulic Brake Adapter - Male Bubble to Tube O.D. Female		

AIR BRAKE
NYLON TUBING

AIR BRAKE
COPPER TUBING

AIR BRAKE
SURELOK

COMPOSITE AIR
BRAKE SURELOK

AIR BRAKE
COMPRESSION
FITTINGS

AIR BRAKE
COUPLINGS FOR
RUBBER HOSE

VALVES

BRASS LOCK-ON
FIELD
ATTACHABLE
COUPLINGS

SINGLE BEAD

BARB STEM

INVERTED FLARE

AUTOMOTIVE
ADAPTERS

COPPER TUBING
INDUSTRIAL
COMPRESSION

INDUSTRIAL
SURELOK

MINI-BARBED
TUBE

POLY
INDUSTRIAL
COMPRESSION

PIPE ADAPTERS

ADAPTERS SAE
FLARE

THREADED
SLEEVE

KITS &
ASSORTMENTS

Gates Global Part Numbering System

Thread Configurations — continued

Air Brake – G55

028 — CTI-MP-CV	Copper Tubing Industrial to Male Pipe - Check Valve	150 — CTI-FP	Copper Tubing Industrial to Female Pipe
030 — TN-CTI-L	Nut - Long	154 — CTI-FP90	Copper Tubing Industrial to Female Pipe - 90°
040 — TSI-CTI	Tube Sleeve Insert	161 — MP-FP-CTI	Copper Tubing Industrial to Male Pipe to Female Pipe Run Tee
050 — TS-CTI	Tube Sleeve	300 — CTI-CTI-BKHD	Copper Tubing Industrial Bulkhead Union
060 — TSN-CTI	Tube Sleeve Nut	400 — CTI-CTI	Copper Tubing Industrial Union
100 — CTI-MP	Copper Tubing Industrial to Male Pipe	404 — CTI-CTI90	Copper Tubing Industrial Union - 90°
104 — CTI-MP90	Copper Tubing Industrial to Male Pipe - 90°	450 — CTI-CTI-CTI	Copper Tubing Industrial Union - Tee
130 — MP-CTI-CTI	Copper Tubing Industrial Run Tee to Male Pipe		
134 — CTI-CTI-MP	Copper Tubing Industrial Branch Tee to Male Pipe		

Air Brake – G56

050 — PLUG-SLI	Industrial SureLok Plug	150 — SLI-FP	Industrial SureLok to Female Pipe
099 — CARTRIDGE-SLI	Industrial SureLok Cartridge	300 — SLI-SLI-BKHD	Industrial SureLok Bulkhead Union
100 — SLI-MP	Industrial SureLok to Male Pipe	400 — SLI-SLI	Industrial SureLok Union
104 — SLI-MP90	Industrial SureLok to Male Pipe - 90°	402 — SLI-SLI-D	Industrial SureLok Double Union
124 — SLI-MPX90	Industrial SureLok to Male Pipe Swivel - 90°	404 — SLI-SLI90	Industrial SureLok Union - 90°
140 — MPX-SLI-SLI	Industrial SureLok Run Tee to Male Pipe Swivel	450 — SLI-SLI-SLI	Industrial SureLok Union - Tee
142 — SLI-SLI-MPX	Industrial SureLok Branch Tee to Male Pipe Swivel	975 — SLI-SLI-SLI-Y	Air Brake Union Y
		978 — MPX-SLI-SLI-Y	Air Brake Run Y to Male Pipe

Air Brake – G57

050 — PLUG-MBT	Plug	300 — MBT-MBT-BKHD	Mini-Barb Bulkhead Union
100 — MBT-MP	Mini-Barb to Male Pipe	350 — MBT-MFA-BKHD	Mini-Barb to Copper Tubing Industrial Compression Assembly Bulkhead
104 — MBT-MP90	Mini-Barb to Male Pipe - 90°	400 — MBT-MBT	Mini-Barb Union
130 — MP-MBT-MBT	Mini-Barb Run Tee to Male Pipe	401 — MBT-MBTL	Mini-Barb Union - Long
150 — MBT-FP	Mini-Barb to Female Pipe	404 — MBT-MBT90	Mini-Barb Union - 90°
154 — MBT-FP90	Mini-Barb to Female Pipe - 90°	452 — MBT-MBT-MBT	Mini-Barb Union - Tee
160 — MBT-MBT-FP	Mini-Barb Branch Tee to Female Pipe		
190 — MBT-MFA	Mini-Barb to Industrial Copper Tubing Compression		

Air Brake – G58

050 — TSI-PVC	Tubing Sleeve	134 — PVC-PVC-MP	Compression PVC Branch Tee to Male Pipe
060 — TSN-PVC	Tubing Sleeve Nut	150 — PVC-FP	Compression PVC to Female Pipe
100 — PVC-MP	Compression PVC to Male Pipe	400 — PVC-PVC	Compression PVC Union
104 — PVC-MP90	Compression PVC to Male Pipe - 90°		

Adapters – G60

593 — DCN	Threaded Sleeve Nut	615 — MP-FPB-L	Male Pipe to Female Pipe - Long
594 — DCN-MP	Threaded Sleeve to Male Pipe	618 — MP-FP45	Male Pipe to Female Pipe - 45°
595 — DCN-MP90	Threaded Sleeve to Male Pipe - 90°	620 — MP-FPB90	Male Pipe to Female Pipe - 90°
596 — T-MIXN-S	Male Inverted Tube Nut - Steel	623 — MP-FP-MS	Male Pipe to Female Pipe to Male SAE 45° Flare - Split Run Tee
597 — T-MIXN-SL	Male Inverted Tube Nut - Steel - Long	625 — MP-FI	Female Inverted Flare to Male Pipe
599 — T-MIXN-B	Male Inverted Tube Nut - Brass	626 — MP-FI45	Female Inverted Flare to Male Pipe - 45°
600 — FPB-CAP	Female Pipe Cap	627 — MP-FI90	Female Inverted Flare to Male Pipe - 90°
601 — MPB-PLUG	Male Pipe Plug - Hex Head	628 — FI-FI-MP	Female Inverted Branch Tee to Male Pipe
602 — MPB-PLUG-SQ HEAD	Male Pipe Plug - Square Head	629 — MP-FI-FI	Female Inverted Run Tee to Male Pipe
603 — MPB-PLUG-HK HEAD	Male Pipe Plug - Hex Key Head	630 — FP-FI	Female Inverted to Female Pipe
604 — MPB-PLUG-SL	Male Pipe Plug - Slotted Head	631 — FP-FPB	Female Pipe to Female Pipe
605 — MP-MP	Male Pipe to Male Pipe Hex Nipple	632 — FP-FPXB	Female Pipe to Female Pipe Swivel Union
605 — MP-MPB	Male Pipe to Male Pipe Hex Nipple	633 — MP-FPR	Male Pipe to Female Pipe - Restriction
606 — MP-MPB-CNS	Male Pipe to Male Pipe Close Nipple	635 — FP-FPB45	Female Pipe to Female Pipe - 45°
607 — MP-MPB-CNL	Male Pipe to Male Pipe Medium Nipple	637 — FP-FPB90	Female Pipe to Female Pipe - 90°
608 — MP-MPB-CNXL	Male Pipe to Male Pipe Long Nipple	639 — FP-FP-FP-FPB	Female Pipe - Cross
610 — MP-MPB90	Male Pipe NPTF to Male Pipe NPTF - 90°	640 — FP-FP-FPB	Female Pipe - Union Tee
612 — MP-MP-MPB	Male Pipe NPTF Union - Tee	641 — FP-MP-FPB	Male Pipe Run Tee to Female Pipe
614 — MP-FPB	Male Pipe to Female Pipe - Reducer	642 — FP-FP-MPB	Male Pipe Branch Tee to Female Pipe
		643 — FSCAP	Female SAE 45° Flare Cap

Gates Global Part Numbering System

Thread Configurations — continued

Adapters – G60 — continued

644 — MS-PLUG	Male SAE Plug	671 — MS-MS-MS	SAE 45° Flare Union Tee Brass
645 — MS-MS	Male SAE 45° Flare to Male SAE 45° Flare	675 — FSN-S	Female SAE 45° Flare Nut - Short
648 — MS-MS90	Male SAE 45° Flare to Male SAE 45° Flare - 90°	676 — FSN-L	Female SAE 45° Flare Nut - Long
650 — MS-MP	Male SAE 45° Flare to Male Pipe	679 — MS-MI	Male SAE 45° - Male Inverted
652 — MS-MP45	Male SAE 45° Flare to Male Pipe - 45°	680 — MSCROSS	Male SAE 45° Flare - Cross
654 — MS-MP90	Male SAE 45° Flare to Male Pipe - 90°	690 — MS-MP-CV	Male SAE 45° Flare to Male Pipe - Check Valve
657 — MS-MS-MP	Male SAE 45° Flare Run Tee to Male Pipe	691 — MI-PLUG	Male Inverted Flare Plug
659 — MP-MS-MS	Male SAE 45° Flare Branch Tee to Male Pipe	693 — FI-FI	Female Inverted to Female Inverted Union
660 — MS-FP	Male SAE 45° Flare to Female Pipe	694 — FI-FI90	Female Inverted to Female Inverted Union - 90°
664 — MS-FP90	Male SAE 45° Flare to Female Pipe - 90°	695 — FI-FI-FI	Female Inverted Union - Tee
669 — MS-MS-MS	SAE 45° Flare Union Tee Brass	696 — FI-FI-FP	Female Inverted Branch Tee to Female Pipe
670 — MS-MS-MS	SAE 45° Flare Union Tee Brass		

Brass Stemed Fittings – G36

100 — LOC-RMP	Male Pipe with Cone Seat	210 — LOC-RFJSX	Dual Seat Female JIC 37°/SAE 45° Flare Swivel
105 — LOC-RMPX	Male Pipe Swivel without Cone Seat	500 — LOC-RMIX	Male SAE Inverted Flare Swivel
106 — LOC-RMP90	Male Pipe 90° Block with Cone Seat	508 — LOC-RFI	Female SAE Inverted Flare
110 — LOC-RFP	Female Pipe without Cone Seat	520 — LOC-RFT	North American Stand Pipe
111 — LOC-RFPX	Female Pipe Swivel with Cone Seat	520 — LOC-RSP	North American Stand Pipe
165 — LOC-RMJ	Male JIC 37° Flare	535 — LOC-RHM	Hose Length Extenders
170 — LOC-RFJX	Female JIC 37° Flare Swivel	795 — LOC-MBSPT	Male British Standard Pipe Tapered
195 — LOC-RMS	Male SAE 45° Flare		
200 — LOC-RFSX	Female SAE 45° Flare Swivel		

Brass Stemed Fittings – G37

100 — SB-RMP	Male Pipe with Cone Seat	500 — SB-RMIX	Male SAE Inverted Flare Swivel
103 — SB-MS	Male Straight Thread Connector	503 — SB-RMIX45	Male SAE Inverted Flare Swivel - 45°
106 — SB-RMP90	Male Pipe 90° Block Cone Seat	504 — SB-RMIX90	Male SAE Inverted Flare Swivel - 90°
195 — SB-RMS	Male SAE 45° Flare Connector	508 — SB-RFI	Female SAE Inverted Flare

Brass Stemed Fittings – G38

100 — BS-MP	Male Pipe NPTF with Cone Seat	110 — BS-FP	Female Pipe NPTF
--------------------	-------------------------------	--------------------	------------------

Stem Styles

100 — MP	Male Pipe with Cone Seat	210 — FJSX	Dual Seat Female JIC 37°/SAE 45° Flare Swivel
103 — MSC	Male Straight Thread Connector	500 — MIX	Male SAE Inverted Flare Swivel
105 — MPX	Male Pipe Swivel without Cone Seat	503 — MIX45	Male SAE Inverted Flare Swivel - 45°
106 — MP90	Male Pipe 90° Block	504 — MIX90	Male SAE Inverted Flare Swivel - 90°
110 — FP	Female Pipe without Cone Seat	508 — FI	Female SAE Inverted Flare
111 — FPX	Female Pipe Swivel with Cone Seat	520 — SP	North American Stand Pipe
170 — FJX	Female JIC 37° Flare Swivel	535 — HLE	Hose Length Extenders
195 — MS	Male SAE 45° Flare		
200 — FSX	Female SAE 45° Flare Swivel		

AIR BRAKE
NYLON TUBING

AIR BRAKE
COPPER TUBING

AIR BRAKE
SURELOK

COMPOSITE AIR
BRAKE SURELOK

AIR BRAKE
COMPRESSION
FITTINGS

AIR BRAKE
COUPLINGS FOR
RUBBER HOSE

VALVES

BRASS LOCK-ON
FIELD
ATTACHABLE
COUPLINGS

SINGLE BEAD

BARB STEM

INVERTED FLARE

AUTOMOTIVE
ADAPTERS

COPPER TUBING
INDUSTRIAL
COMPRESSION

INDUSTRIAL
SURELOK

MINI-BARBED
TUBE

POLY
INDUSTRIAL
COMPRESSION

PIPE ADAPTERS

ADAPTERS SAE
FLARE

THREADED
SLEEVE

KITS &
ASSORTMENTS

Torque Recommendations for Brass Couplings

AIR BRAKE NYLON TUBING
AIR BRAKE COPPER TUBING
AIR BRAKE SURELOK
COMPOSITE AIR BRAKE SURELOK
AIR BRAKE COMPRESSION FITTINGS
AIR BRAKE COUPLINGS FOR RUBBER HOSE
VALVES
BRASS LOCK-ON FIELD ATTACHABLE COUPLINGS
SINGLE BEAD
BARB STEM
INVERTED FLARE
AUTOMOTIVE ADAPTERS
COPPER TUBING INDUSTRIAL COMPRESSION
INDUSTRIAL SURELOK
MINI-BARBED TUBE
POLY INDUSTRIAL COMPRESSION
PIPE ADAPTERS
ADAPTERS SAE FLARE
THREADED SLEEVE
KITS & ASSORTMENTS

The art of making leak-proof connections with hydraulic couplings starts with tightening connectors properly at the time of installation. An over-tightened coupling may be just as apt to leak as an under-tightened connector. Over-tightening a coupling may result in nut cracking, seat damage, leaks or premature failure.

The torque values in the following tables give the minimum and maximum torque recommendations. The minimum value will create a leak-proof seal under most conditions. Applying torque values greater than the maximum recommendation will distort and/or crack the fitting. Values listed in SAE J514 are for qualification testing only and should not be used as the basis for setting up torque values for a production environment. These need to be established based on the coupling manufacturer's recommendations.

When tightening couplings, make sure that the hose does not twist on the adapter. Twisting will shorten hose life and scar the sealing surfaces of swivel-type couplings (JIC, 45°, etc.), which can create leaks. For straight couplings, use a torque wrench on the hex swivel nut and a standard box wrench on the stem hex. Bent tube couplings can be restrained by holding onto the ferrule. When a crow's foot wrench is used with a torque wrench, adjustments to the torque readings must be made, otherwise over-tightening will occur. The distance "E" as shown below from the center of the drive socket to the center of the crow's foot must be added to the torque value reading.

The following equation can be used to make these adjustments:

$$\text{Actual Torque} = \frac{(E + L)}{L} \times (\text{Torque Wrench Reading}), \text{ where:}$$

- "L" is in inches
- "E" is in inches
- Torque is in in.-lb., ft.-lb., or Newton-Meters

An example of using this equation is shown below:

Torque wrench reading = 45 ft.-lb.

E = 1.5 inches

L = 12 inches

$$\text{Actual Torque} = \frac{(1.5 + 12)}{12} \times 45 = 50.6 \text{ ft.-lb.}$$

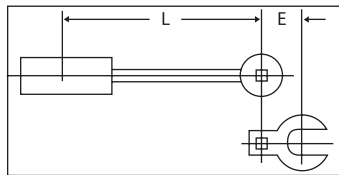

This example shows that the actual torque is approximately 10% higher than the reading indicates. All torque recommendations are based on dry threads. If oil or thread sealant is used, the maximum recommended torque values could be decreased by as much as 25%.

For 37° & 45° (Machined, Flared or Inverted Seats)

Size		Brass			
		Ft.-Lbs.		Newton-Meters	
Dash	Fractional (In.)	Min.	Max.	Min.	Max.
-4	1/4	5	6	7	9
-5	5/16	7	9	10	13
-6	3/8	12	15	17	20
-8	1/2	20	24	28	33
-10	5/8	34	40	46	55
-12	3/4	53	60	72	82

Maximum Recommended Torque for Dry NPTF (Tapered) Pipe*

Size		Ft.-Lb.	Newton-Meters
Dash	Fractional (In.)		
-2	1/8	13	16
-4	1/4	16	23
-6	3/8	23	29
-8	1/2	29	39
-12	3/4	36	49
-16	1	42	59

***NOTES:**

1. The torque values obtained from tightening pipe threads can vary considerably depending on thread condition. Adequate sealing can occur at values much lower than the maximum values listed above. Only enough torque to achieve adequate sealing should be used.
2. When using a male tapered pipe thread with a female straight or parallel pipe thread, maximum values are 50% of those listed in the table.
3. If thread sealant is used, maximum values shown should be decreased by 25%.

Equipment & Tools

Nylon Tubing Cutter – Part No. 78015

Gives straight, clean, square cuts on J844 tubing from 1/8" to 3/4".

- Lightweight and compact size.
- Designed to ensure user's safety.
- "Blade guard" offers more protection against accidental blade contact.
- Ribbed handle ensures improved grip.

Gates also offers replacement blades in a five-pack bag (Part No. 78016).



SureLok™ Quick-Release Pliers

SureLok™ push-to-connect couplings are the easiest and quickest couplings to install. But disconnecting them can be another matter. Placement near obstructions, as well as age and road debris, can adversely affect your ability to quickly disconnect SureLok couplings. Many times getting hands into an area to remove a coupling is almost impossible.

SureLok pliers allow for the quick removal of SureLok couplings from the tubing with just one hand. To help get into those tight spaces, SureLok pliers offer two different heads: one straight and one at a 90° angle. They also come in two sizes: small for tubing from 1/8" to 3/8"; and large for tubing from 3/8" to 3/4".

SureLok Plier Single Packs:

- Small Angle:** Part No. 91021
- Small Straight:** Part No. 91023
- Large Angle:** Part No. 91020
- Large Straight:** Part No. 91022

SureLok Plier Four-Pack: Part No. 91017



AIR BRAKE
NYLON TUBING

AIR BRAKE
COPPER TUBING

AIR BRAKE
SURELOK

COMPOSITE AIR
BRAKE SURELOK

AIR BRAKE
COMPRESSION
FITTINGS

AIR BRAKE
COUPLINGS FOR
RUBBER HOSE

VALVES

BRASS LOCK-ON
FIELD
ATTACHABLE
COUPLINGS

SINGLE BEAD

BARB STEM

INVERTED FLARE

AUTOMOTIVE
ADAPTERS

COPPER TUBING
INDUSTRIAL
COMPRESSION

INDUSTRIAL
SURELOK

MINI-BARBED
TUBE

POLY
INDUSTRIAL
COMPRESSION

PIPE ADAPTERS

ADAPTERS SAE
FLARE

THREADED
SLEEVE

KITS &
ASSORTMENTS

Air Brake Nylon Tubing

Recommended For: Truck, bus and mobile air brake, and service lines where heat and battery acids are not present. Conforms to SAE J844 specifications. Meets DOT FMVSS 106-74.

Tube: Heat and light stabilized seamless extruded nylon.

Reinforcement: Type A: Non-reinforced in sizes 1/8", 5/32", 3/16" and 1/4". NOTE: 1/8" and 5/32" are NOT recognized by DOT for air brake systems, these are for service lines only.

Type B: Reinforced with one open ply of fibrous nylon in sizes 5/16", 3/8", 1/2", 5/8" and 3/4".



Cover: Nylon. Available in black (NABTA), blue (NABTB), green (NABTG), red (NABTR), yellow (NABTY), orange (NABTO), purple (NABTP), brown (NABTN), silver (NABTS) and white (NABTW) colors. Other colors available upon request.

Temperature Range: -40°F to +200°F (-40°C to +93°C).



	Part No.	Desc.	Tube O.D.	Reinforcement Type			Minimum Bend Radius
			"				"
AIR BRAKE NYLON TUBING	H30000-02	2NABTAXLG REEL	1/8	A	150	800	.37
	H30000-04	4NABTAXLG REEL	1/4	A	150	800	1.0
AIR BRAKE COPPER TUBING	H30000-05	5NABTAXREEL	5/16	B	150	800	1.25
	H30000-06	6NABTAXLG REEL	3/8	B	150	800	1.5
AIR BRAKE SURELOK	H30000-08	8NABTAXREEL	1/2	B	150	760	2.0
	H30000-10	10NABTAXREEL	5/8	B	150	720	2.5
COMPOSITE AIR BRAKE SURELOK	H30000-12	12NABTAXREEL	3/4	B	150	640	3.0
	H30002-02	2NABTA X100FT	1/8	A	150	800	.37
AIR BRAKE COMPRESSION FITTINGS	H30002-03	3NABTA X100FT	3/16	A	150	800	.75
	H30002-04	4NABTA X100FT	1/4	A	150	800	1.0
AIR BRAKE COUPLINGS FOR RUBBER HOSE	H30002-05	5NABTA X100FT	5/16	B	150	800	1.25
	H30002-06	6NABTA X100FT	3/8	B	150	800	1.5
VALVES	H30002-08	8NABTA X100FT	1/2	B	150	760	2.0
	H30002-25	2.5NABTA X100FT	5/32	A	150	800	.5
BRASS LOCK-ON FIELD ATTACHABLE COUPLINGS	H30003-10	10NABTA X50FT	5/8	B	150	720	2.5
	H30003-12	12NABTA X50FT	3/4	B	150	640	3.0
SINGLE BEAD	H30005-06	6NABTAXREEL	3/8	B	150	800	1.5
	H30010-04	4NABTNXREEL	1/4	A	150	800	1.0
BARB STEM	H30010-06	6NABTNXREEL	3/8	B	150	800	1.25
	H30020-06	6NABTWXREEL	3/8	B	150	800	1.25
INVERTED FLARE	H30030-04	4NABTPXLG REEL	1/4	A	150	800	1.0
	H30040-04	4NABTGXREEL	1/4	A	150	800	1.0
AUTOMOTIVE ADAPTERS	H30040-06	6NABTGXLG REEL	3/8	B	150	800	1.25
	H30040-10	10NABTGXREEL	5/8	B	150	640	3.5
COPPER TUBING INDUSTRIAL COMPRESSION	H30042-04	4NABTG X100FT	1/4	A	150	800	1.0
	H30042-06	6NABTG X100FT	3/8	B	150	800	1.25
INDUSTRIAL SURELOK	H30042-08	8NABTG X100FT	1/2	B	150	760	2.0
	H30043-10	10NABTG X50FT	5/8	B	150	640	3.5
MINI-BARBED TUBE	H30043-12	12NABTG X50FT	3/4	B	150	640	3.0
	H30045-06	6NABTGXREEL	3/8	B	150	760	1.25
POLY INDUSTRIAL COMPRESSION	H30045-08	8NABTGXREEL	1/2	B	150	720	2.0
	H30050-04	4NABTRXREEL	1/4	A	150	800	1.0
PIPE ADAPTERS	H30050-06	6NABTRXLG REEL	3/8	B	150	800	1.25
	H30050-10	10NABTRXREEL	5/8	B	150	720	3.5
ADAPTERS SAE FLARE	H30052-04	4NABTR X100FT	1/4	A	150	800	1.0
	H30052-06	6NABTR X100FT	3/8	B	150	800	1.25
THREADED SLEEVE	H30052-08	8NABTR X100FT	1/2	B	150	760	2.0
	H30053-10	10NABTR X50FT	5/8	B	150	720	3.5
KITS & ASSORTMENTS	H30053-12	12NABTR X50FT	3/4	B	150	640	3.0
	H30055-06	6NABTRXREEL	3/8	B	150	800	1.25
	H30055-08	8NABTRXREEL	1/2	B	150	760	2.0

Air Brake Nylon Tubing - Continued

Part No.	Desc.	Tube O.D.	Reinforcement Type			Minimum Bend Radius
		"				"
H30060-04	4NABTBXREEL	1/4	A	150	800	1.0
H30060-06	6NABTBXLG REEL	3/8	B	150	800	1.25
H30061-04	4NABTBXLG REEL	1/4	A	150	800	1.0
H30062-04	4NABTB X100FT	1/4	A	150	800	1.0
H30062-06	6NABTB X100FT	3/8	B	150	800	1.25
H30062-08	8NABTB X100FT	1/2	B	150	760	2.0
H30063-10	10NABTB X50FT	5/8	B	150	720	2.5
H30063-12	12NABTB X50FT	3/4	B	150	640	3.0
H30065-06	6NABTBXREEL	3/8	B	150	800	1.25
H30065-08	8NABTBXREEL	1/2	B	150	760	2.0
H30070-04	4NABTYXREEL	1/4	A	150	800	1.0
H30070-06	6NABTYXREEL	3/8	B	150	800	1.25
H30072-04	4NABTY X100FT	1/4	A	150	800	1.0
H30072-06	6NABTY X100FT	3/8	B	150	800	1.25
H30072-08	8NABTY X100FT	1/2	B	150	760	2.0
H30073-10	10NABTY X50FT	5/8	B	150	720	2.5
H30073-12	12NABTY X50FT	3/4	B	150	640	3.0
H30080-06	6NABTOXREEL	3/8	B	150	1120	1.25
H30080-10	10NABTOXREEL	5/8	B	150	720	2.5
H30082-04	4NABTO X100FT	1/4	A	150	960	1.0
H30082-06	6NABTO X100FT	3/8	B	150	1120	1.25
H30082-08	8NABTO X100FT	1/2	B	150	760	2.0
H30083-10	10NABTO X50FT	5/8	B	150	720	2.5
H30083-12	12NABTO X50FT	3/4	B	150	640	3.0
H30090-04	4NABTSXREEL	1/4	A	150	800	1.0
H30090-08	8NABTSXREEL	1/2	B	150	760	2.0

AIR BRAKE NYLON TUBING

AIR BRAKE COPPER TUBING

AIR BRAKE SURELOK

COMPOSITE AIR BRAKE SURELOK

AIR BRAKE COMPRESSION FITTINGS

AIR BRAKE COUPLINGS FOR RUBBER HOSE

VALVES

BRASS LOCK-ON FIELD ATTACHABLE COUPLINGS

SINGLE BEAD

BARB STEM

INVERTED FLARE

AUTOMOTIVE ADAPTERS

COPPER TUBING INDUSTRIAL COMPRESSION

INDUSTRIAL SURELOK

MINI-BARBED TUBE

POLY INDUSTRIAL COMPRESSION

PIPE ADAPTERS

ADAPTERS SAE FLARE

THREADED SLEEVE

KITS & ASSORTMENTS

- AIR BRAKE NYLON TUBING
- AIR BRAKE COPPER TUBING
- AIR BRAKE SURELOK
- COMPOSITE AIR BRAKE SURELOK
- AIR BRAKE COMPRESSION FITTINGS
- AIR BRAKE COUPLINGS FOR RUBBER HOSE
- VALVES
- BRASS LOCK-ON FIELD ATTACHABLE COUPLINGS
- SINGLE BEAD
- BARB STEM
- INVERTED FLARE
- AUTOMOTIVE ADAPTERS
- COPPER TUBING INDUSTRIAL COMPRESSION
- INDUSTRIAL SURELOK
- MINI-BARBED TUBE
- POLY INDUSTRIAL COMPRESSION
- PIPE ADAPTERS
- ADAPTERS SAE FLARE
- THREADED SLEEVE
- KITS & ASSORTMENTS

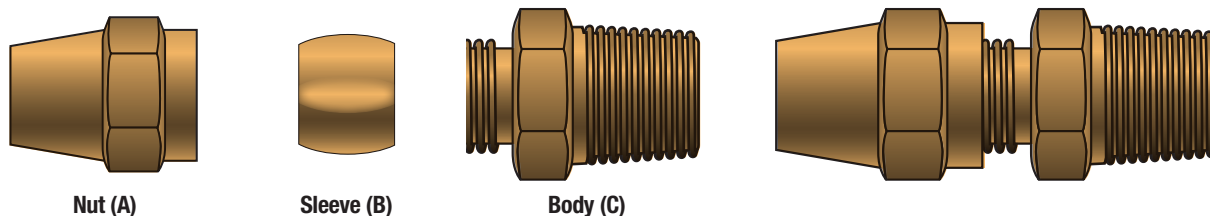

Tube O.D. (in)	1/4	3/8	1/2	5/8	3/4	1
Thread Size	7/16-24	17/32-24	11/16-20	13/16-18	1-18	1-1/4-16

Recommended For: Air brake systems - compressed air connectors or suspension, steering, engine, transmission or on auxiliary components.

Used With: Copper tubing in air brake systems.

Features and Benefits: Easy to assemble, no flaring tools required. Versatile - can be used with nylon tubing by replacing the long nut and sleeve with an insert, rigid sleeve and nut.

Conformance: Meets DOT FMVSS 571.106, SAE J246 and J1131 requirements.

Working Pressure: 150 psi (10 bar)

Temperature Range: -65°F to +250°F (-53°C to +121°C)

Material: 360 Brass

Assembly Instructions:

1. Measure tubing to required length. Using a cutting tool, cut the tubing as straight as possible making sure to remove any burrs with a wire brush or other de-burring tool.
2. Slide nut "A" and then sleeve "B" onto tubing. Threaded end of nut "A" must face toward the connector body "C".
3. Insert tubing into connector. Be sure tubing is bottomed on fitting shoulder.
4. Thread nut "A" onto connector body "C" until it is hand tight, then using a wrench, tighten the connection by the number of turns indicated in the chart below.

Tube Size O.D. (in)	1/4, 3/8	1/2, 5/8, 3/4
Turns from Hand Tight	1-3/4	3-1/4

Coiled Air Brake Tubing

Each Kit contains two color coded hoses; blue for service, red for emergency.

Recommended For: Truck air brake lines from back of cab to trailer. Conforms to SAE J844 specifications. Meets DOT FMVSS 106. 12" Leads.



Tube: Heat and light stabilized seamless extruded Nylon 11.

Reinforcement: One open ply of fibrous nylon.

Cover: Heat and light stabilized seamless extruded nylon.

Temperature Range: -40°F to +200°F



Part No.	Desc.			
		"		
G30050-1208	8CABHX12	1/2	150	600
G30050-1508	8CABHX15	1/2	150	600

Tube Sleeve

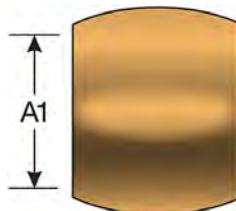

Part No.	Desc.	A1	Standard Pack
		"	
G30050-0004	4TS-ABCT	1/4	10
G30050-0006	6TS-ABCT	3/8	5
G30050-0008	8TS-ABCT	1/2	5
G30050-0010	10TS-ABCT	5/8	5
G30050-0012	12TS-ABCT	3/4	5

AIR BRAKE
NYLON TUBING

AIR BRAKE
COPPER TUBING

AIR BRAKE
SURELOK

COMPOSITE AIR
BRAKE SURELOK

AIR BRAKE
COMPRESSION
FITTINGS

AIR BRAKE
COUPLINGS FOR
RUBBER HOSE

VALVES

BRASS LOCK-ON
FIELD
ATTACHABLE
COUPLINGS

SINGLE BEAD

BARB STEM

INVERTED FLARE

AUTOMOTIVE
ADAPTERS

COPPER TUBING
INDUSTRIAL
COMPRESSION

INDUSTRIAL
SURELOK

MINI-BARBED
TUBE

POLY
INDUSTRIAL
COMPRESSION

PIPE ADAPTERS

ADAPTERS SAE
FLARE

THREADED
SLEEVE

KITS &
ASSORTMENTS

- AIR BRAKE NYLON TUBING
- AIR BRAKE COPPER TUBING
- AIR BRAKE SURELOK
- COMPOSITE AIR BRAKE SURELOK
- AIR BRAKE COMPRESSION FITTINGS
- AIR BRAKE COUPLINGS FOR RUBBER HOSE
- VALVES
- BRASS LOCK-ON FIELD ATTACHABLE COUPLINGS
- SINGLE BEAD
- BARB STEM
- INVERTED FLARE
- AUTOMOTIVE ADAPTERS
- COPPER TUBING INDUSTRIAL COMPRESSION
- INDUSTRIAL SURELOK
- MINI-BARBED TUBE
- POLY INDUSTRIAL COMPRESSION
- PIPE ADAPTERS
- ADAPTERS SAE FLARE
- THREADED SLEEVE
- KITS & ASSORTMENTS

Tube Sleeve Nut

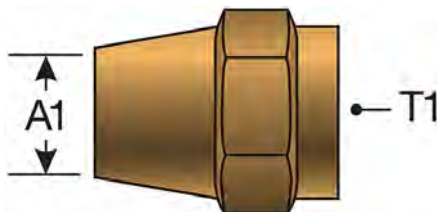

Part No.	Desc.	A1		Standard Pack
		"	T1 (in)	
G30060-0004	4TSN-ABCT	1/4	7/16-24	1
G30060-0006	6TSN-ABCT	3/8	17/32-24	1
G30060-0008	8TSN-ABCT	1/2	11/16-20	1
G30060-0010	10TSN-ABCT	5/8	13/16-18	1
G30060-0012	12TSN-ABCT	3/4	1-18	1

Air Brake to Male Pipe

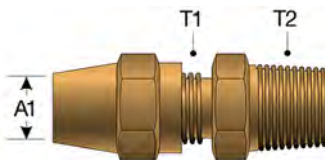

Part No.	Desc.	A1			Standard Pack
		"	T1 (in)	T2 (in)	
G30100-0402	4ABCT-2MP	1/4	7/16-24	1/8-27	1
G30100-0404	4ABCT-4MP	1/4	7/16-24	1/4-18	1
G30100-0406	4ABCT-6MP	1/4	7/16-24	3/8-18	1
G30100-0602	6ABCT-2MP	3/8	17/32-24	1/8-27	1
G30100-0604	6ABCT-4MP	3/8	17/32-24	1/4-18	1
G30100-0606	6ABCT-6MP	3/8	17/32-24	3/8-18	1
G30100-0608	6ABCT-8MP	3/8	17/32-24	1/2-14	1
G30100-0804	8ABCT-4MP	1/2	11/16-20	1/4-18	1
G30100-0806	8ABCT-6MP	1/2	11/16-20	3/8-18	1
G30100-0808	8ABCT-8MP	1/2	11/16-20	1/2-14	1
G30100-1006	10ABCT-6MP	5/8	13/16-18	3/8-18	1
G30100-1008	10ABCT-8MP	5/8	13/16-18	1/2-14	1
G30100-1208	12ABCT-8MP	3/4	1-18	1/2-14	1

Air Brake to Male Pipe - 45°

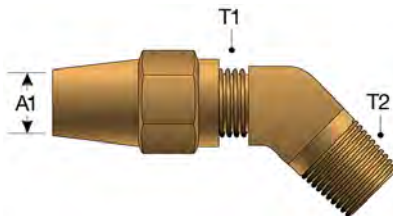

Part No.	Desc.	A1			Standard Pack	
			"	T1 (in)		T2 (in)
G30102-0604	6ABCT-4MP45	3/8		17/32-24	1/4-18	1
G30102-0606	6ABCT-6MP45	3/8		17/32-24	3/8-18	1
G30102-0806	8ABCT-6MP45	1/2		11/16-20	3/8-18	1
G30102-1008	10ABCT-8MP45	5/8		13/16-18	1/2-14	1

Air Brake to Male Pipe - 90°

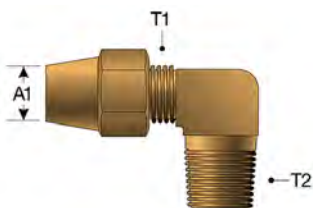

Part No.	Desc.	A1			Standard Pack	
			"	T1 (in)		T2 (in)
G30104-0402	4ABCT-2MP90	1/4		7/16-24	1/8-27	1
G30104-0404	4ABCT-4MP90	1/4		7/16-24	1/4-18	1
G30104-0602	6ABCT-2MP90	3/8		17/32-24	1/8-27	1
G30104-0604	6ABCT-4MP90	3/8		17/32-24	1/4-18	1
G30104-0606	6ABCT-6MP90	3/8		17/32-24	3/8-18	1
G30104-0608	6ABCT-8MP90	3/8		17/32-24	1/2-14	1
G30104-0804	8ABCT-4MP90	1/2		11/16-20	1/4-18	1
G30104-0806	8ABCT-6MP90	1/2		11/16-20	3/8-18	1
G30104-0808	8ABCT-8MP90	1/2		11/16-20	1/2-14	1
G30104-1006	10ABCT-6MP90	5/8		13/16-18	3/8-18	1
G30104-1008	10ABCT-8MP90	5/8		13/16-18	1/2-14	1
G30104-1208	12ABCT-8MP90	3/4		1-18	1/2-14	1

AIR BRAKE
NYLON TUBING

AIR BRAKE
COPPER TUBING

AIR BRAKE
SURELOK

COMPOSITE AIR
BRAKE SURELOK

AIR BRAKE
COMPRESSION
FITTINGS

AIR BRAKE
COUPLINGS FOR
RUBBER HOSE

VALVES

BRASS LOCK-ON
FIELD
ATTACHABLE
COUPLINGS

SINGLE BEAD

BARB STEM

INVERTED FLARE

AUTOMOTIVE
ADAPTERS

COPPER TUBING
INDUSTRIAL
COMPRESSION

INDUSTRIAL
SURELOK

MINI-BARBED
TUBE

POLY
INDUSTRIAL
COMPRESSION

PIPE ADAPTERS

ADAPTERS SAE
FLARE

THREADED
SLEEVE

KITS &
ASSORTMENTS

- AIR BRAKE NYLON TUBING
- AIR BRAKE COPPER TUBING
- AIR BRAKE SURELOK
- COMPOSITE AIR BRAKE SURELOK
- AIR BRAKE COMPRESSION FITTINGS
- AIR BRAKE COUPLINGS FOR RUBBER HOSE
- VALVES
- BRASS LOCK-ON FIELD ATTACHABLE COUPLINGS
- SINGLE BEAD
- BARB STEM
- INVERTED FLARE
- AUTOMOTIVE ADAPTERS
- COPPER TUBING INDUSTRIAL COMPRESSION
- INDUSTRIAL SURELOK
- MINI-BARBED TUBE
- POLY INDUSTRIAL COMPRESSION
- PIPE ADAPTERS
- ADAPTERS SAE FLARE
- THREADED SLEEVE
- KITS & ASSORTMENTS

Air Brake to Male Pipe - 90° - Long

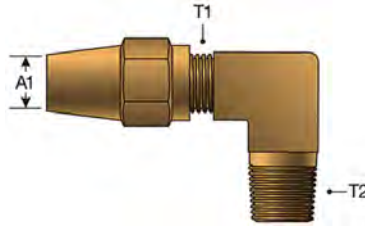

Part No.	Desc.	A1	T		Standard Pack
		"	T1 (in)	T2 (in)	
G30106-0602	6ABCT-2MP90L	3/8	17/32-24	1/8-27	1
G30106-0604	6ABCT-4MP90L	3/8	17/32-24	1/4-18	1
G30106-0806	8ABCT-6MP90L	1/2	11/16-20	3/8-18	1

Air Brake Run Tee to Male Pipe

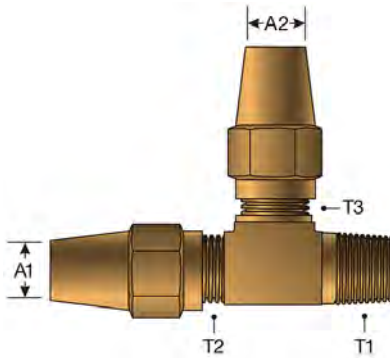

Part No.	Desc.	A1	A2	T			Standard Pack
		"	"	T1 (in)	T2 (in)	T3 (in)	
G30130-0406	4MP-6ABCT-6ABCT	3/8	3/8	1/4-18	17/32-24	17/32-24	1
G30130-0606	6MP-6ABCT-6ABCT	3/8	3/8	3/8-18	17/32-24	17/32-24	1
G30130-0608	6MP-8ABCT-8ABCT	1/2	1/2	3/8-18	11/16-20	11/16-20	1

Air Brake Branch Tee to Male Pipe

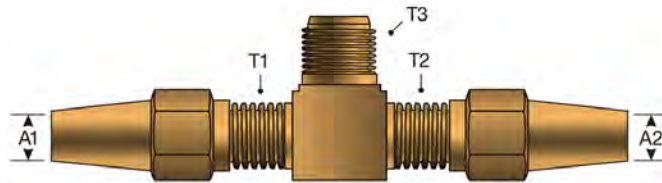



Part No.	Desc.	A1	A2	T			Standard Pack
		"	"	T1 (in)	T2 (in)	T3 (in)	
G30135-0602	6ABCT-6ABCT-2MP	3/8	3/8	17/32-24	17/32-24	1/8-27	1
G30135-0604	6ABCT-4ABCT-4MP	3/8	1/4	17/32-24	7/16-24	1/4-18	1
G30135-0606	6ABCT-6ABCT-6MP	3/8	3/8	17/32-24	17/32-24	3/8-18	1

Air Brake Branch Tee to Male Pipe - Continued

Part No.	Desc.	A1	A2				Standard Pack
		"	"	T1 (in)	T2 (in)	T3 (in)	
G30135-0806	8ABCT-6ABCT-8MP	1/2	3/8	11/16-20	17/32-24	1/2-14	1

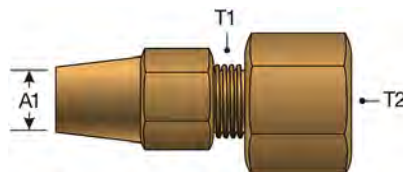
Air Brake to Female Pipe



Part No.	Desc.	A1			Standard Pack
		"	T1 (in)	T2 (in)	
G30150-0602	6ABCT-2FP	3/8	17/32-24	1/8-27	1
G30150-0604	6ABCT-4FP	3/8	17/32-24	1/4-18	1
G30150-0606	6ABCT-6FP	3/8	17/32-24	3/8-18	1
G30150-0806	8ABCT-6FP	1/2	11/16-20	3/8-18	1

Air Brake to Female Pipe - 90°

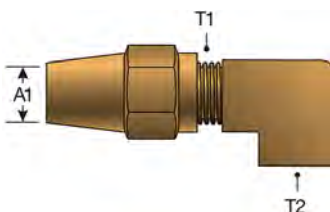

Part No.	Desc.	A1			Standard Pack
		"	T1 (in)	T2 (in)	
G30154-0604	6ABCT-4FP90	3/8	17/32-24	1/4-18	1
G30154-0806	8ABCT-6FP90	1/2	11/16-20	3/8-18	1

Air Brake Union

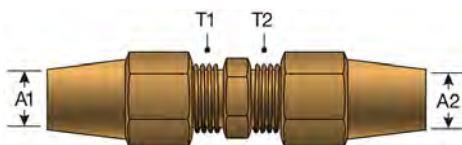

Part No.	Desc.	A1	A2			Standard Pack
		"	"	T1 (in)	T2 (in)	
G30400-0404	4ABCT-4ABCT	1/4	1/4	7/16-24	7/16-24	1
G30400-0606	6ABCT-6ABCT	3/8	3/8	17/32-24	17/32-24	1
G30400-0808	8ABCT-8ABCT	1/2	1/2	11/16-20	11/16-20	1

AIR BRAKE
NYLON TUBING

AIR BRAKE
COPPER TUBING

AIR BRAKE
SURELOK

COMPOSITE AIR
BRAKE SURELOK

AIR BRAKE
COMPRESSION
FITTINGS

AIR BRAKE
COUPLINGS FOR
RUBBER HOSE

VALVES

BRASS LOCK-ON
FIELD
ATTACHABLE
COUPLINGS

SINGLE BEAD

BARB STEM

INVERTED FLARE

AUTOMOTIVE
ADAPTERS

COPPER TUBING
INDUSTRIAL
COMPRESSION

INDUSTRIAL
SURELOK

MINI-BARBED
TUBE

POLY
INDUSTRIAL
COMPRESSION

PIPE ADAPTERS

ADAPTERS SAE
FLARE

THREADED
SLEEVE

KITS &
ASSORTMENTS

AIR BRAKE NYLON TUBING

AIR BRAKE COPPER TUBING

AIR BRAKE SURELOK

COMPOSITE AIR BRAKE SURELOK

AIR BRAKE COMPRESSION FITTINGS

AIR BRAKE COUPLINGS FOR RUBBER HOSE

VALVES

BRASS LOCK-ON FIELD ATTACHABLE COUPLINGS

SINGLE BEAD

BARB STEM

INVERTED FLARE

AUTOMOTIVE ADAPTERS

COPPER TUBING INDUSTRIAL COMPRESSION

INDUSTRIAL SURELOK

MINI-BARBED TUBE

POLY INDUSTRIAL COMPRESSION

PIPE ADAPTERS

ADAPTERS SAE FLARE

THREADED SLEEVE

KITS & ASSORTMENTS

Air Brake Union - Continued

Part No.	Desc.	A1	A2	T1 (in) T2 (in)		Standard Pack
		"	"			
G30400-1010	10ABCT-10ABCT	5/8	5/8	13/16-18	13/16-18	1
G30400-1212	12ABCT-12ABCT	3/4	3/4	1-18	1-18	1

Air Brake Union - 90°

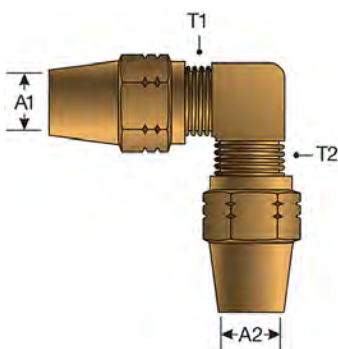

Part No.	Desc.	A1	A2	T1 (in) T2 (in)		Standard Pack
		"	"			
G30404-0606	6ABCT-6ABCT90	3/8	3/8	17/32-24	17/32-24	1
G30404-0808	8ABCT-8ABCT90	1/2	1/2	11/16-20	11/16-20	1
G30404-1010	10ABCT-10ABCT90	5/8	5/8	13/16-18	13/16-18	1

Air Brake Union - Tee

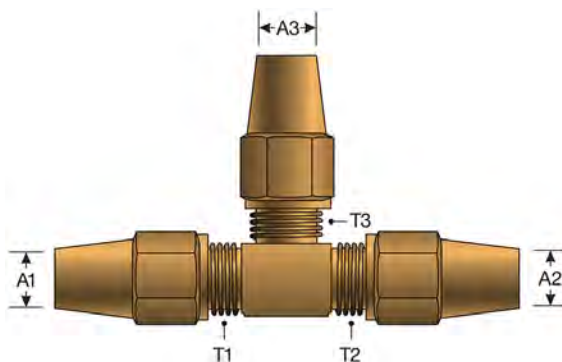

Part No.	Desc.	A1	A2	A3	T1 (in) T2 (in) T3 (in)			Standard Pack
		"	"	"				
G30450-0606	6ABCT-6ABCT-6ABCT	3/8	3/8	3/8	17/32-24	17/32-24	17/32-24	1
G30450-0808	8ABCT-8ABCT-8ABCT	1/2	1/2	1/2	11/16-20	11/16-20	11/16-20	1

Recommended For: Air brake systems - compressed air connectors or suspension, steering, engine, transmission or other onboard vehicle applications. Not for fuel, oil or water.

Used With: Nylon Tubing (SAE J844 or DIN 74324)

Features and Benefits: Easy to assemble, push to connect, one piece fitting. Reusable and field serviceable. Designed for strength and durability. Provides significant reduction in air system leakage.

Conformance: Fittings meet DOT FMVSS 571.106, SAE J1131, DIN 74324 and German TUV requirements.

Working Pressure: 150 psi (10 bar)

Temperature Range: -40°F to +200°F (-40°C to +93°C)

Material: 360 Brass

Seal: O-Ring - Ethylene Propylene

Component Functions:

Body:	Internal and external machined thread for connection to ports. Machining retains collet, tube support and O-Ring.
Tube Support:	Prevents tube collapse during severe loading conditions.
Collet:	Collet teeth grip the tube, holding it firmly in the fitting.
O-Ring:	Internal O-Ring provides a seal and necessary interference between tube and fitting body.

Assembly Instructions:

1. Ensure the tubing end is cut straight, and is clean and free of burrs.
2. Push tube through the open collet end and into the fitting.
3. Continue pushing tube through O-Ring until it bottoms out. Now pull back on tube to help set the collet teeth.
4. To disconnect, first ensure there is no residual air in system, then push the tube into fitting until it bottoms out. Hold down and compress the collet using SureLok™ Quick Release Pliers, or other tool, and remove the tube from the fitting.

AIR BRAKE
NYLON TUBING

AIR BRAKE
COPPER TUBING

AIR BRAKE
SURELOK

COMPOSITE AIR
BRAKE SURELOK

AIR BRAKE
COMPRESSION
FITTINGS

AIR BRAKE
COUPLINGS FOR
RUBBER HOSE

VALVES

BRASS LOCK-ON
FIELD
ATTACHABLE
COUPLINGS

SINGLE BEAD

BARB STEM

INVERTED FLARE

AUTOMOTIVE
ADAPTERS

COPPER TUBING
INDUSTRIAL
COMPRESSION

INDUSTRIAL
SURELOK

MINI-BARBED
TUBE

POLY
INDUSTRIAL
COMPRESSION

PIPE ADAPTERS

ADAPTERS SAE
FLARE

THREADED
SLEEVE

KITS &
ASSORTMENTS

Air Brake Plugs

Recommended For: Compressed air as a connector on all air brake systems at locations other than between chassis frame and axle or between towed and towing vehicle. Also as a connector on all air operated systems as applicable to suspension, steering, engine, transmission and auxiliary mechanisms. Fittings and tubing comply to DOT FMVSS 106, mandatory requirements for inch tube fittings is U.S.A., Society for Automotive Engineers (SAE J1131, inch tube and fittings) and meets DIN 74324 and German TUV requirements (metric tube and fittings).

Temperature Range: -40°F to +200°F (-40°C to +100°C).



Part No.	Desc.	∅	L		Standard Pack
		"	"	mm	
G31050-0004	4AB-PLUG	1/4	1.12	28.5	1
G31050-0006	6AB-PLUG	3/8	1.34	34.0	1
G31050-0008	8AB-PLUG	1/2	1.48	37.6	1
G31050-0025	2.5AB-PLUG	5/32	1.04	26.4	1

Air Brake Cartridge

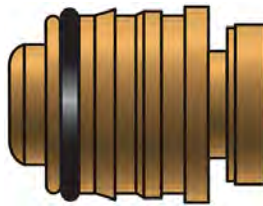

Part No.	Desc.	∅	Standard Pack
		"	
G31080-0003	3CARTRIDGE-AB	3/16	1
G31080-0004	4CARTRIDGE-AB	1/4	1
G31080-0006	6CARTRIDGE-AB	3/8	1
G31080-0008	8CARTRIDGE-AB	1/2	1
G31080-0010	10CARTRIDGE-AB	5/8	1
G31080-0012	12CARTRIDGE-AB	3/4	1
G31080-0025	25CARTRIDGE-AB	5/32	1

Air Brake to Male Pipe

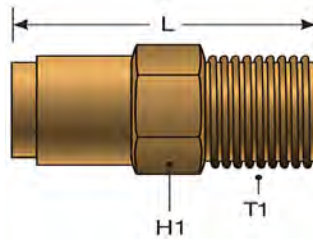

Part No.	Desc.			H1	L		Standard Pack
		"	T1 (in)		"	mm	
G31100-0202	2AB-2MP	1/8	1/8-27	7/16	.67	17.0	1
G31100-0302	3AB-2MP	3/16	1/8-27	1/2	1.02	25.9	1
G31100-0401	4AB-1MP	1/4	1/16-32	7/16	.94	23.9	1
G31100-0402	4AB-2MP	1/4	1/8-27	1/2	1.04	26.4	1
G31100-0404	4AB-4MP	1/4	1/4-18	9/16	1.17	29.7	1
G31100-0406	4AB-6MP	1/4	3/8-18	11/16	1.20	30.5	1
G31100-0602	6AB-2MP	3/8	1/8-27	11/16	1.32	33.5	1
G31100-0604	6AB-4MP	3/8	1/4-18	11/16	1.48	37.6	1
G31100-0606	6AB-6MP	3/8	3/8-18	11/16	1.42	36.1	1
G31100-0608	6AB-8MP	3/8	1/2-14	7/8	1.46	37.1	1
G31100-0804	8AB-4MP	1/2	1/4-18	7/8	1.68	42.7	1
G31100-0806	8AB-6MP	1/2	3/8-18	7/8	1.64	41.7	1
G31100-0808	8AB-8MP	1/2	1/2-14	7/8	1.72	43.7	1
G31100-1006	10AB-6MP	5/8	3/8-18	11/16	1.87	47.5	1
G31100-1008	10AB-8MP	5/8	1/2-14	11/16	2.12	53.9	1
G31100-1208	12AB-8MP	3/4	1/2-14	13/16	2.11	53.6	1
G31100-1212	12AB-12MP	3/4	3/4-14	1 1/16	2.21	56.1	1
G31100-2501	2.5AB-1MP	5/32	1/16-32	11/32	.43	10.9	1
G31100-2502	2.5AB-2MP	5/32	1/8-27	7/16	.89	22.6	1

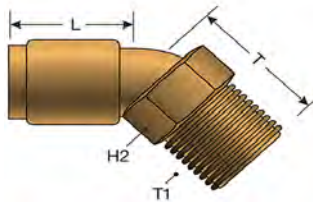

Air Brake to Male Pipe - 45°



Part No.	Desc.			H2	T		L		Standard Pack
		"	T1 (in)		"	mm	"	mm	
G31102-0402	4AB-2MP45	1/4	1/8-27	14.30	.81	20.6	1.68	42.7	1
G31102-0404	4AB-4MP45	1/4	1/4-18	14.30	.98	24.9	1.87	47.5	1
G31102-0602	6AB-2MP45	3/8	1/8-27	19	.93	23.6	1.95	49.5	1
G31102-0604	6AB-4MP45	3/8	1/4-18	19	1.10	27.9	2.16	54.9	1
G31102-0606	6AB-6MP45	3/8	3/8-18	19	1.12	28.5	2.22	56.4	1
G31102-0608	6AB-8MP45	3/8	1/2-14	22	1.30	33.0	2.44	62.0	1
G31102-0804	8AB-4MP45	1/2	1/4-18	22	1.10	27.9	2.32	58.9	1
G31102-0806	8AB-6MP45	1/2	3/8-18	22	1.12	28.5	2.38	60.5	1
G31102-0808	8AB-8MP45	1/2	1/2-14	22	1.30	33.0	2.60	66.0	1
G31102-1006	10AB-6MP45	5/8	3/8-18	27	1.02	25.9	2.48	63.0	1
G31102-1008	10AB-8MP45	5/8	1/2-14	27	1.22	31.0	2.68	68.1	1



- AIR BRAKE NYLON TUBING
- AIR BRAKE COPPER TUBING
- AIR BRAKE SURELOK**
- COMPOSITE AIR BRAKE SURELOK
- AIR BRAKE COMPRESSION FITTINGS
- AIR BRAKE COUPLINGS FOR RUBBER HOSE
- VALVES
- BRASS LOCK-ON FIELD ATTACHABLE COUPLINGS
- SINGLE BEAD
- BARB STEM
- INVERTED FLARE
- AUTOMOTIVE ADAPTERS
- COPPER TUBING INDUSTRIAL COMPRESSION
- INDUSTRIAL SURELOK
- MINI-BARBED TUBE
- POLY INDUSTRIAL COMPRESSION
- PIPE ADAPTERS
- ADAPTERS SAE FLARE
- THREADED SLEEVE
- KITS & ASSORTMENTS

Air Brake to Male Pipe - 45° - Continued

Part No.	Desc.			H2	T		L		Standard Pack
		"	T1 (in)		"	mm	"	mm	
G31102-1208	12AB-8MP45	3/4	1/2-14	25.40	1.30	33.0	2.82	71.6	1
G31102-1212	12AB-12MP45	3/4	3/4-14	27	1.91	48.5	3.92	99.6	1

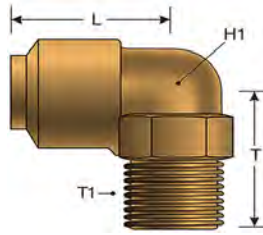
Air Brake to Male Pipe - 90°



Part No.	Desc.			H1	T		L		Standard Pack
		"	T1 (in)		mm	"	mm	"	
G31104-0202	2AB-2MP90	1/8	1/8-27	7	.66	16.8	.67	17.0	1
G31104-0302	3AB-2MP90	3/16	1/8-27	12	.75	19.1	.81	20.6	1
G31104-0402	4AB-2MP90	1/4	1/8-27	14	.79	20.1	.81	20.6	1
G31104-0404	4AB-4MP90	1/4	1/4-18	18	1.02	25.9	.87	22.1	1
G31104-0406	4AB-6MP90	1/4	3/8-18	22	1.10	27.9	.94	23.9	1
G31104-0408	4AB-8MP90	1/4	1/2-14	24	1.38	35.1	.96	24.4	1
G31104-0602	6AB-2MP90	3/8	1/8-27	18	.87	22.1	1.08	27.4	1
G31104-0604	6AB-4MP90	3/8	1/4-18	18	1.02	25.9	1.06	26.9	1
G31104-0606	6AB-6MP90	3/8	3/8-18	22	1.10	27.9	1.14	29.0	1
G31104-0608	6AB-8MP90	3/8	1/2-14	24	1.38	35.1	1.14	29.0	1
G31104-0804	8AB-4MP90	1/2	1/4-18	22	1.14	29.0	1.22	31.0	1
G31104-0806	8AB-6MP90	1/2	3/8-18	22	1.14	29.0	1.26	32.0	1
G31104-0808	8AB-8MP90	1/2	1/2-14	24	1.38	35.1	1.28	32.5	1
G31104-1006	10AB-6MP90	5/8	3/8-18	22	1.22	31.0	1.44	36.9	1
G31104-1008	10AB-8MP90	5/8	1/2-14	30	1.42	36.1	1.54	39.1	1
G31104-1208	12AB-8MP90	3/4	1/2-14	24	1.48	37.6	1.52	38.6	1
G31104-1212	12AB-12MP90	3/4	3/4-14	27	2.00	50.8	2.15	54.6	1
G31104-2501	25AB-1MP90	5/32	1/16-32	7	1.00	25.4	1.00	25.4	1
G31104-2502	2.5AB-2MP90	5/32	1/8-27	7	1.00	25.4	.87	22.1	1

Air Brake to Male Pipe - 90° with Port

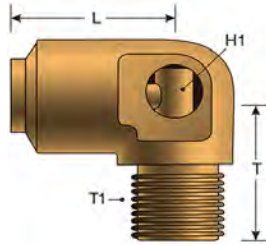

Part No.	Desc.			H1	T		L		Standard Pack
		"	T1 (in)		"	mm	"	mm	
G31105-0604P	6AB-4MP-2PT90	3/8	1/4-18	1/8	1.10	27.9	1.20	30.5	1
G31105-0606P	6AB-6MP-2PT90	3/8	3/8-18	1/8	1.10	27.9	1.12	28.5	1
G31105-0806P	8AB-6MP-2PT90	1/2	3/8-18	1/8	1.14	29.0	1.26	32.0	1
G31105-0808P	8AB-8MP-4PT90	1/2	1/2-14	1/4	1.38	35.1	1.28	32.5	1
G31105-1212P	12AB-12MP-4PT90	3/4	3/4-14	1/4	1.48	37.6	1.52	38.6	1

Air Brake to Male Pipe Swivel - 45°

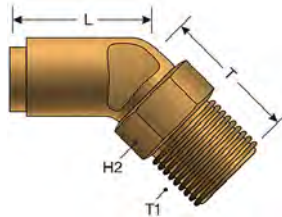

Part No.	Desc.			H2	T		L		Standard Pack
		"	T1 (in)		"	mm	"	mm	
G31122-0402	4AB-2MPX45	1/4	1/8-27	7/16	1.06	26.9	.74	18.8	1
G31122-0404	4AB-4MPX45	1/4	1/4-18	9/16	1.11	28.2	.77	19.6	1
G31122-0602	6AB-2MPX45	3/8	1/8-27	9/16	1.05	26.7	1.05	26.7	1
G31122-0604	6AB-4MPX45	3/8	1/4-18	11/16	1.26	32.0	1.05	26.7	1
G31122-0808	8AB-8MPX45	1/2	1/2-14	7/8	1.62	41.2	1.25	31.8	1
G31122-1008	10AB-8MPX45	5/8	1/2-14	7/8	1.42	36.1	1.51	38.4	1

AIR BRAKE
NYLON TUBING

AIR BRAKE
COPPER TUBING

AIR BRAKE
SURELOK

COMPOSITE AIR
BRAKE SURELOK

AIR BRAKE
COMPRESSION
FITTINGS

AIR BRAKE
COUPLINGS FOR
RUBBER HOSE

VALVES

BRASS LOCK-ON
FIELD
ATTACHABLE
COUPLINGS

SINGLE BEAD

BARB STEM

INVERTED FLARE

AUTOMOTIVE
ADAPTERS

COPPER TUBING
INDUSTRIAL
COMPRESSION

INDUSTRIAL
SURELOK

MINI-BARBED
TUBE

POLY
INDUSTRIAL
COMPRESSION

PIPE ADAPTERS

ADAPTERS SAE
FLARE

THREADED
SLEEVE

KITS &
ASSORTMENTS

Air Brake to Male Pipe Swivel - 90°

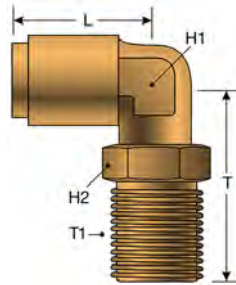

Part No.	Desc.			H1	H2	T		L		Standard Pack
		"	T1 (in)	mm	mm	"	mm	"	mm	
G31124-0402	4AB-2MPX90	1/4	1/8-27	14	11	.91	23.1	.83	21.1	1
G31124-0404	4AB-4MPX90	1/4	1/4-18	18	14	1.12	28.5	.83	21.1	1
G31124-0406	4AB-6MPX90	1/4	3/8-18	22	19	1.25	31.8	.85	21.6	1
G31124-0602	6AB-2MPX90	3/8	1/8-27	18	14	1.05	26.7	1.07	27.2	1
G31124-0604	6AB-4MPX90	3/8	1/4-18	18	19	1.29	32.8	1.07	27.2	1
G31124-0606	6AB-6MPX90	3/8	3/8-18	22	19	1.24	31.5	1.07	27.2	1
G31124-0608	6AB-8MPX90	3/8	1/2-14	24	22	1.44	36.6	1.07	27.2	1
G31124-0804	8AB-4MPX90	1/2	1/4-18	22	22	1.27	32.3	1.27	32.3	1
G31124-0806	8AB-6MPX90	1/2	3/8-18	22	22	1.42	36.1	1.27	32.3	1
G31124-0808	8AB-8MPX90	1/2	1/2-14	24	22	1.62	41.2	1.27	32.3	1
G31124-1006	10AB-6MPX90	5/8	3/8-18	30	22	1.48	37.6	1.54	39.1	1
G31124-1008	10AB-8MPX90	5/8	1/2-14	30	22	1.48	37.6	1.54	39.1	1
G31124-1208	12AB-8MPX90	3/4	1/2-14	24	22	1.53	38.9	1.55	39.4	1
G31124-2502	2.5AB-2MPX90	5/32	1/8-27	7	11	.91	23.1	.83	21.1	1

Air Brake Run Tee to Male Pipe

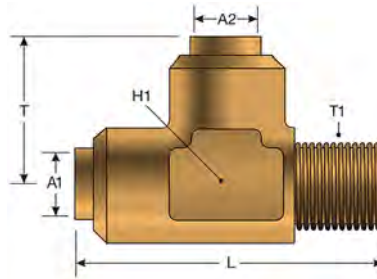



Part No.	Desc.	A1	A2		H1	T		L		Standard Pack
		"	"	T1 (in)	mm	"	mm	"	mm	
G31130-0204	2MP-4AB-4AB	1/4	1/4	1/8-27	14	.89	22.6	1.67	42.4	1
G31130-0404	4MP-4AB-4AB	1/4	1/4	1/4-18	18	.89	22.6	1.85	47.0	1
G31130-0406	4MP-6AB-6AB	3/8	3/8	1/4-18	18	1.08	27.4	2.05	52.1	1
G31130-0604	6MP-4AB-4AB	1/4	1/4	3/8-18	22	.93	23.6	2.03	51.6	1
G31130-0606	6MP-6AB-6AB	3/8	3/8	3/8-18	22	1.14	29.0	2.24	56.9	1
G31130-0608	6MP-8AB-8AB	1/2	1/2	3/8-18	22	1.30	33.0	2.44	62.0	1
G31130-0806	8MP-6AB-6AB	3/8	3/8	1/2-14	24	1.22	31.0	2.64	67.1	1
G31131-0406	4MP-4AB-6AB	1/4	3/8	1/4-18	18	1.08	27.4	1.85	47.0	1
G31131-0604	6MP-4AB-6AB	1/4	3/8	3/8-18	22	1.14	29.0	2.03	51.6	1
G31131-0608	6MP-6AB-8AB	3/8	1/2	3/8-18	22	1.30	33.0	2.36	59.9	1
G31132-0406	4MP-6AB-4AB	3/8	1/4	1/4-18	18	.93	23.6	2.05	52.1	1
G31132-0604	6MP-6AB-4AB	3/8	1/4	3/8-18	22	.93	23.6	2.24	56.9	1

Air Brake Run Tee to Male Pipe - Continued

Part No.	Desc.	A1	A2		H1	T		L		Standard Pack
		"	"	T1 (in)	mm	"	mm	"	mm	
G31132-0608	6MP-8AB-6AB	1/2	3/8	3/8-18	22	1.22	31.0	2.44	62.0	1

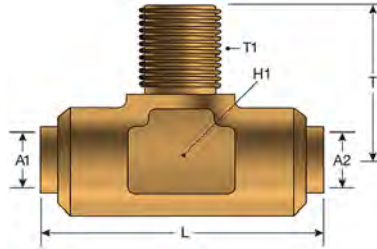
Air Brake Branch Tee to Male Pipe



Part No.	Desc.	A1	A2		H1	T		L		Standard Pack
		"	"	T1 (in)	mm	"	mm	"	mm	
G31134-0302	3AB-3AB-2MP	3/16	3/16	1/8-27	14	.79	20.1	1.69	42.9	1
G31134-0402	4AB-4AB-2MP	1/4	1/4	1/8-27	14	.79	20.1	1.69	42.9	1
G31134-0404	4AB-4AB-4MP	1/4	1/4	1/4-18	18	.96	24.4	1.77	45.0	1
G31134-0406	4AB-4AB-6MP	1/4	1/4	3/8-18	22	1.10	27.9	1.93	49.0	1
G31134-0604	6AB-6AB-4MP	3/8	3/8	1/4-18	18	.96	24.4	2.17	55.1	1
G31134-0606	6AB-6AB-6MP	3/8	3/8	3/8-18	22	1.10	27.9	2.28	57.9	1
G31134-0804	8AB-8AB-4MP	1/2	1/2	1/4-18	22	1.14	29.0	2.44	62.0	1
G31134-0806	8AB-8AB-6MP	1/2	1/2	3/8-18	22	1.14	29.0	2.60	66.0	1
G31134-0808	8AB-8AB-8MP	1/2	1/2	1/2-14	24	1.42	36.1	2.68	68.1	1
G31135-0604	6AB-4AB-4MP	3/8	1/4	1/4-18	18	.96	24.4	1.97	50.0	1
G31135-0806	8AB-6AB-8MP	1/2	3/8	1/2-14	22	1.22	31.0	2.48	63.0	1
G31136-1008	10AB-8AB-8MP	5/8	1/2	1/2-14	30	1.46	37.1	2.78	70.6	1

Air Brake Branch Y to Male Pipe - 90°

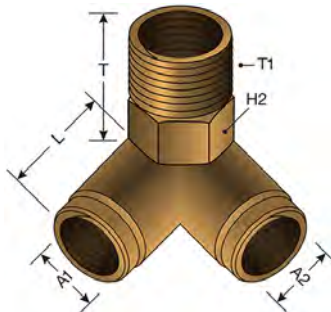

Part No.	Desc.	A1	A2		H2	T		L		Standard Pack
		"	"	T1 (in)	mm	"	mm	"	mm	
G31138-0606	6AB-6AB-6MP90	3/8	3/8	3/8-18	22	1.34	34.0	1.18	30.0	1

- AIR BRAKE NYLON TUBING
- AIR BRAKE COPPER TUBING
- AIR BRAKE SURELOK
- COMPOSITE AIR BRAKE SURELOK
- AIR BRAKE COMPRESSION FITTINGS
- AIR BRAKE COUPLINGS FOR RUBBER HOSE
- VALVES
- BRASS LOCK-ON FIELD ATTACHABLE COUPLINGS
- SINGLE BEAD
- BARB STEM
- INVERTED FLARE
- AUTOMOTIVE ADAPTERS
- COPPER TUBING INDUSTRIAL COMPRESSION
- INDUSTRIAL SURELOK
- MINI-BARBED TUBE
- POLY INDUSTRIAL COMPRESSION
- PIPE ADAPTERS
- ADAPTERS SAE FLARE
- THREADED SLEEVE
- KITS & ASSORTMENTS

Air Brake Run Tee to Male Pipe Swivel

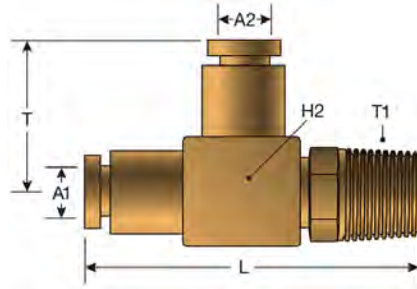

Part No.	Desc.	A1	A2		H2	T		L		Standard Pack
		"	"	T1 (in)	mm	"	mm	"	mm	
G31140-0204	2MPX-4AB-4AB	1/4	1/4	1/8-27	11	.83	21.1	1.75	44.5	1
G31140-0404	4MPX-4AB-4AB	1/4	1/4	1/4-18	14	.83	21.1	1.95	49.5	1
G31140-0406	4MPX-6AB-6AB	3/8	3/8	1/4-18	19	1.07	27.2	2.36	59.9	1
G31140-0606	6MPX-6AB-6AB	3/8	3/8	3/8-18	19	1.07	27.2	2.32	58.9	1
G31140-0608	6MPX-8AB-8AB	1/2	1/2	3/8-18	22	1.27	32.3	2.69	68.3	1
G31140-0808	8MPX-8AB-8AB	1/2	1/2	1/2-14	22	1.27	32.3	2.89	73.4	1

Air Brake Branch Tee to Male Pipe Swivel

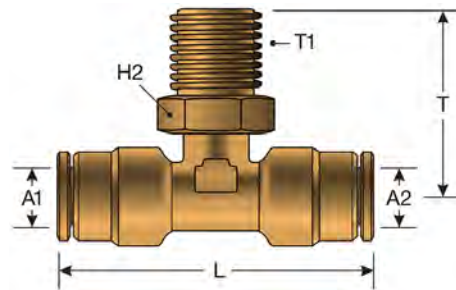

Part No.	Desc.	A1	A2		H2	T		L		Standard Pack
		"	"	T1 (in)	mm	"	mm	"	mm	
G31142-0302	3AB-3AB-2MPX	3/16	3/16	1/8-27	11	.89	22.6	1.57	39.9	1
G31142-0402	4AB-4AB-2MPX	1/4	1/4	1/8-27	11	.91	23.1	1.67	42.4	1
G31142-0404	4AB-4AB-4MPX	1/4	1/4	1/4-18	14	1.12	28.5	1.67	42.4	1
G31142-0602	6AB-6AB-2MPX	3/8	3/8	1/8-27	14	1.09	27.7	1.92	48.8	1
G31142-0604	6AB-6AB-4MPX	3/8	3/8	1/4-18	19	1.29	32.8	2.17	55.1	1
G31142-0606	6AB-6AB-6MPX	3/8	3/8	3/8-18	19	1.24	31.5	2.17	55.1	1
G31142-0804	8AB-8AB-4MPX	1/2	1/2	1/4-18	22	1.39	35.3	2.56	65.0	1
G31142-0806	8AB-8AB-6MPX	1/2	1/2	3/8-18	22	1.42	36.1	2.56	65.0	1
G31142-0808	8AB-8AB-8MPX	1/2	1/2	1/2-14	22	1.62	41.2	2.56	65.0	1

Air Brake to Female Pipe

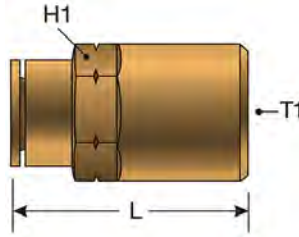

Part No.	Desc.	O		H1	L		Standard Pack
		"	T1 (in)	"	"	mm	
G31150-0402	4AB-2FP	1/4	1/8-27	9/16	1.31	33.3	1
G31150-0404	4AB-4FP	1/4	1/4-18	11/16	1.59	40.4	1
G31150-0602	6AB-2FP	3/8	1/8-27	9/16	1.74	44.2	1
G31150-0604	6AB-4FP	3/8	1/4-18	11/16	1.74	44.2	1
G31150-0606	6AB-6FP	3/8	3/8-18	7/8	1.78	45.2	1
G31150-0804	8AB-4FP	1/2	1/4-18	11/16	2.00	50.8	1
G31150-0808	8AB-8FP	1/2	1/2-14	11/16	2.11	53.6	1
G31150-2502	2.5AB-2FP	5/32	1/8-27	9/16	1.18	30.0	1

Air Brake to Female Pipe - 90°

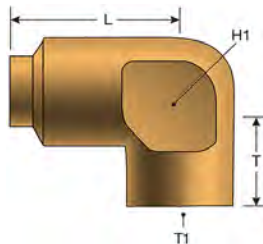

Part No.	Desc.	O		H1	T		L		Standard Pack
		"	T1 (in)	mm	"	mm	"	mm	
G31154-0302	3AB-2FP90	3/16	1/8-27	14	.71	18.0	.87	22.1	1
G31154-0402	4AB-2FP90	1/4	1/8-27	14	.71	18.0	.94	23.9	1
G31154-0404	4AB-4FP90	1/4	1/4-18	18	.79	20.1	1.08	27.4	1
G31154-0406	4AB-6FP90	1/4	3/8-18	18	.79	20.1	1.08	27.4	1
G31154-0602	6AB-2FP90	3/8	1/8-27	13	.79	20.1	1.31	33.3	1
G31154-0604	6AB-4FP90	3/8	1/4-18	18	.79	20.1	1.31	33.3	1
G31154-0606	6AB-6FP90	3/8	3/8-18	22	.79	20.1	1.31	33.3	1
G31154-0804	8AB-4FP90	1/2	1/4-18	18	.94	23.9	1.16	29.5	1
G31154-0806	8AB-6FP90	1/2	3/8-18	22	.94	23.9	1.16	29.5	1
G31154-0808	8AB-8FP90	1/2	1/2-14	16	.94	23.9	1.16	29.5	1

AIR BRAKE
NYLON TUBING

AIR BRAKE
COPPER TUBING

AIR BRAKE
SURELOK

COMPOSITE AIR
BRAKE SURELOK

AIR BRAKE
COMPRESSION
FITTINGS

AIR BRAKE
COUPLINGS FOR
RUBBER HOSE

VALVES

BRASS LOCK-ON
FIELD
ATTACHABLE
COUPLINGS

SINGLE BEAD

BARB STEM

INVERTED FLARE

AUTOMOTIVE
ADAPTERS

COPPER TUBING
INDUSTRIAL
COMPRESSION

INDUSTRIAL
SURELOK

MINI-BARBED
TUBE

POLY
INDUSTRIAL
COMPRESSION

PIPE ADAPTERS

ADAPTERS SAE
FLARE

THREADED
SLEEVE

KITS &
ASSORTMENTS

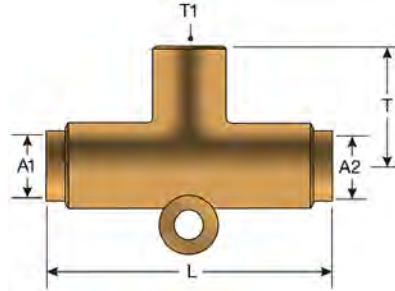

Air Brake Branch Tee to Female Pipe with Mounting Hole



Part No.	Desc.	A1	A2		T		L		Standard Pack
		"	"	T1 (in)	"	mm	"	mm	
G31160-0604	6AB-6AB-4FP	3/8	3/8	1/4-18	1.06	26.9	2.34	59.4	1

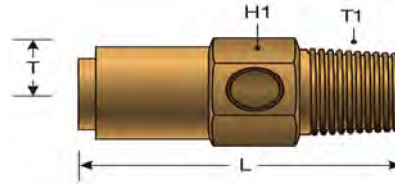

Air Brake to Male Pipe to Female Pipe Split Run Tee - Block Style

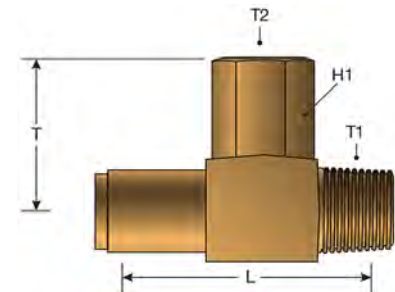

Part No.	Desc.			H1	T		L		Standard Pack
		"	T1 (in)	"	"	mm	"	mm	
G31167-0406	4MP-6AB-4FP	3/8	1/4-18	18	.96	24.4	2.05	52.1	1
G31167-0808	8MP-8AB-2FP	1/2	1/2-14	24	.96	24.4	2.40	61.0	1

Air Brake to Male Pipe to Female Pipe Split Run Tee



Part No.	Desc.			H1	T		L		Standard Pack	
		"	T1 (in)	T2 (in)	mm	"	mm	"		mm
G31168-0604	6AB-6MP-4FP	3/8	3/8-18	1/4-18	22	1.14	29.0	2.05	52.1	1

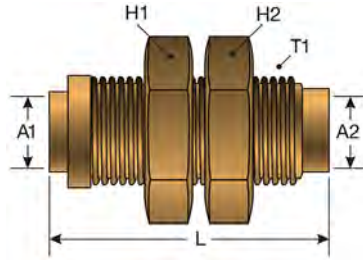

Air Brake Bulkhead Union

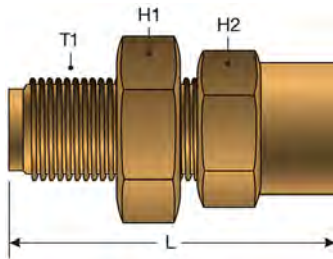

Part No.	Desc.	A1	A2		H1	H2	L		Standard Pack
		"	"	T1 (in)	"	"	"	mm	
G31300-0404	4AB-4AB-BKHD	1/4	1/4	1/4-18	15/16	15/16	1.41	35.8	1
G31300-0606	6AB-6AB-BKHD	3/8	3/8	3/8-18	1 1/8	1 1/8	1.75	44.5	1
G31300-0806	8AB-6AB-BKHD	1/2	3/8	3/8-18	1 1/8	1 1/8	1.89	48.0	1
G31300-0808	8AB-8AB-BKHD	1/2	1/2	1/2-14	1 5/16	1 5/16	2.02	51.3	1
G31300-1010	10AB-10AB-BKHD	5/8	5/8	1/2-14	1 1/2	1 1/2	2.34	59.4	1

Air Brake to Female Pipe Bulkhead



Part No.	Desc.			H1	H2	L		Standard Pack
		"	T1 (in)	mm	"	"	mm	
G31360-0402	4AB-2FP-BKHD	1/4	1/8-27	22	15/16	1.32	33.5	1
G31360-0404	4AB-4FP-BKHD	1/4	1/4-18	22	15/16	1.59	40.4	1
G31360-0604	6AB-4FP-BKHD	3/8	1/4-18	24	1 1/8	2.20	55.9	1
G31360-0606	6AB-6FP-BKHD	3/8	3/8-18	27	1 1/8	2.20	55.9	1
G31360-0608	6AB-8FP-BKHD	3/8	1/2-14	27	1 1/8	2.20	55.9	1
G31360-0806	8AB-6FP-BKHD	1/2	3/8-18	27	1 5/16	1.89	48.0	1
G31360-0808	8AB-8FP-BKHD	1/2	1/2-14	27	1 5/16	2.64	67.1	1

Air Brake Union

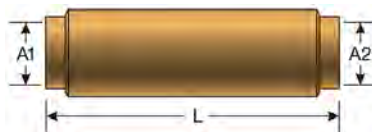

Part No.	Desc.	A1	A2	L		Standard Pack
		"	"	"	mm	
G31400-0202	2AB-2AB	1/8	1/8	1.15	27.2	1
G31400-0303	3AB-3AB	3/16	3/16	1.36	24.5	1

- AIR BRAKE NYLON TUBING
- AIR BRAKE COPPER TUBING
- AIR BRAKE SURELOK
- COMPOSITE AIR BRAKE SURELOK
- AIR BRAKE COMPRESSION FITTINGS
- AIR BRAKE COUPLINGS FOR RUBBER HOSE
- VALVES
- BRASS LOCK-ON FIELD ATTACHABLE COUPLINGS
- SINGLE BEAD
- BARB STEM
- INVERTED FLARE
- AUTOMOTIVE ADAPTERS
- COPPER TUBING INDUSTRIAL COMPRESSION
- INDUSTRIAL SURELOK
- MINI-BARBED TUBE
- POLY INDUSTRIAL COMPRESSION
- PIPE ADAPTERS
- ADAPTERS SAE FLARE
- THREADED SLEEVE
- KITS & ASSORTMENTS

Air Brake Union - Continued

Part No.	Desc.	A1	A2	L		Standard Pack
		"	"	"	mm	
G31400-0404	4AB-4AB	1/4	1/4	1.40	35.6	1
G31400-0604	6AB-4AB	3/8	1/4	1.71	43.4	1
G31400-0606	6AB-6AB	3/8	3/8	1.74	44.2	1
G31400-0806	8AB-6AB	1/2	3/8	1.91	48.5	1
G31400-0808	8AB-8AB	1/2	1/2	2.01	51.1	1
G31400-1010	10AB-10AB	5/8	5/8	2.42	61.5	1
G31400-1212	12AB-12AB	3/4	3/4	2.48	63.0	1
G31400-2525	2.5AB-2.5AB	5/32	5/32	1.18	30.0	1

Air Brake Union - 90°

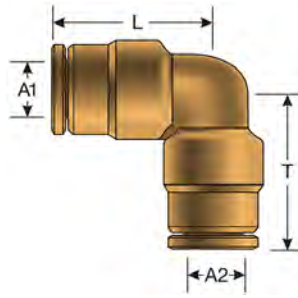

Part No.	Desc.	A1	A2	T		L		Standard Pack
		"	"	"	mm	"	mm	
G31404-0404	4AB-4AB90	1/4	1/4	.83	21.1	.83	21.1	1
G31404-0606	6AB-6AB90	3/8	3/8	1.07	27.2	1.07	27.2	1
G31404-0808	8AB-8AB90	1/2	1/2	1.26	32.0	1.26	32.0	1
G31404-1010	10AB-10AB90	5/8	5/8	1.48	37.6	1.61	40.9	1

Air Brake Union - Tee

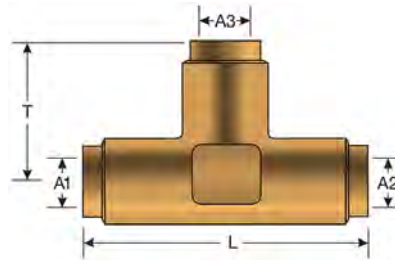

Part No.	Desc.	A1	A2	A3	T		L		Standard Pack
		"	"	"	"	mm	"	mm	
G31450-0202	2AB-2AB-2AB	1/8	1/8	1/8	.63	16.0	1.26	32.0	1
G31450-0303	3AB-3AB-3AB	3/16	3/16	3/16	.72	18.3	1.44	36.9	1
G31450-0404	4AB-4AB-4AB	1/4	1/4	1/4	.93	23.6	1.65	41.9	1
G31450-0606	6AB-6AB-6AB	3/8	3/8	3/8	1.07	27.2	2.13	54.1	1
G31450-0808	8AB-8AB-8AB	1/2	1/2	1/2	1.26	32.0	2.53	64.3	1
G31450-1010	10AB-10AB-10AB	5/8	5/8	5/8	1.54	39.1	3.07	78.0	1
G31450-1212	12AB-12AB-12AB	3/4	3/4	3/4	1.56	39.6	3.12	79.3	1

Air Brake Union - Tee - Continued

Part No.	Desc.	A1	A2	A3	T		L		Standard Pack
		"	"	"	"	mm	"	mm	
G31451-0604	6AB-6AB-4AB	3/8	3/8	1/4	.93	23.6	2.17	55.1	1
G31451-0608	6AB-6AB-8AB	3/8	3/8	1/2	1.28	32.5	2.36	59.9	1
G31451-0804	8AB-8AB-4AB	1/2	1/2	1/4	.98	24.9	2.52	64.0	1
G31451-0806	8AB-8AB-6AB	1/2	1/2	3/8	1.22	31.0	2.44	62.0	1
G31451-1008	10AB-8AB-10AB	5/8	1/2	5/8	1.56	39.6	3.01	76.5	1
G31452-0604	6AB-4AB-4AB	3/8	1/4	1/4	.93	23.6	2.01	51.1	1
G31452-0806	8AB-6AB-6AB	1/2	3/8	3/8	1.18	30.0	2.46	62.5	1

Air Brake Union - Tee with Mounting Hole

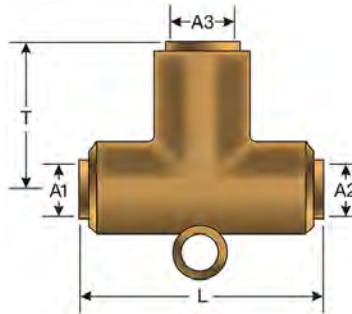

Part No.	Desc.	A1	A2	A3	T		L		Standard Pack
		"	"	"	"	mm	"	mm	
G31453-0608	6AB-6AB-8AB-MH	3/8	3/8	1/2	1.42	36.1	2.36	59.9	1

AIR BRAKE
NYLON TUBING

AIR BRAKE
COPPER TUBING

AIR BRAKE
SURELOK

COMPOSITE AIR
BRAKE SURELOK

AIR BRAKE
COMPRESSION
FITTINGS

AIR BRAKE
COUPLINGS FOR
RUBBER HOSE

VALVES

BRASS LOCK-ON
FIELD
ATTACHABLE
COUPLINGS

SINGLE BEAD

BARB STEM

INVERTED FLARE

AUTOMOTIVE
ADAPTERS

COPPER TUBING
INDUSTRIAL
COMPRESSION

INDUSTRIAL
SURELOK

MINI-BARBED
TUBE

POLY
INDUSTRIAL
COMPRESSION

PIPE ADAPTERS

ADAPTERS SAE
FLARE

THREADED
SLEEVE

KITS &
ASSORTMENTS

AIR BRAKE NYLON TUBING
AIR BRAKE COPPER TUBING
AIR BRAKE SURELOK
COMPOSITE AIR BRAKE SURELOK
AIR BRAKE COMPRESSION FITTINGS
AIR BRAKE COUPLINGS FOR RUBBER HOSE
VALVES
BRASS LOCK-ON FIELD ATTACHABLE COUPLINGS
SINGLE BEAD
BARB STEM
INVERTED FLARE
AUTOMOTIVE ADAPTERS
COPPER TUBING INDUSTRIAL COMPRESSION
INDUSTRIAL SURELOK
MINI-BARBED TUBE
POLY INDUSTRIAL COMPRESSION
PIPE ADAPTERS
ADAPTERS SAE FLARE
THREADED SLEEVE
KITS & ASSORTMENTS

Recommended For: Air brake systems - compressed air connectors or suspension, steering, engine, transmission or other onboard vehicle applications. Not for fuel, oil or water.

Used With: Nylon Tubing (SAE J844 or DIN 74324)

Features and Benefits: Easy to assemble, push to connect, one piece fitting. Reusable and field serviceable. Designed for strength and durability. Provides significant reduction in air system leakage. Composite fittings are up to 70% lighter than comparable brass fittings providing some weight reduction.

Conformance: Meets DOT FMVSS 571.106, SAE J113 and SAE J2494 impact resistance.

Working Pressure: 150 psi (10 bar)

Temperature Range: -40°F to +200°F (-40°C to +93°C)

Materials: High Impact Nylon and Brass

Seals: O-Ring - Buna N; Thread Sealant - Precote® 5

Component Functions:

Body:	Internal and external machined threads for connection to ports. Machining retains collet, tube support and O-Ring.
Tube Support:	Prevents tube collapse during severe loading conditions.
Collet:	Collet teeth grip the tube, holding it firmly in the fitting.
O-Ring:	Internal O-Ring provides a seal and necessary interference between tube and fitting body.

Assembly Instructions:

1. Ensure tubing end is cut straight, and free of burrs.
2. Push tube through the open collet end and into the fitting.
3. Continue pushing tube through O-Ring until it bottoms out. Pull back on tube to help set the collet teeth.
4. To disconnect, first ensure there is no residual air in system, then push the tube into fitting until it bottoms out. Next, compress the collet by holding down. Use SureLok™ Quick Release Pliers, or other tool, to remove tube from the fitting.

Precote® 5 is a registered trademark of omniTECHNIK, Mikroverkapselungs GmbH.

6-Port Manifold

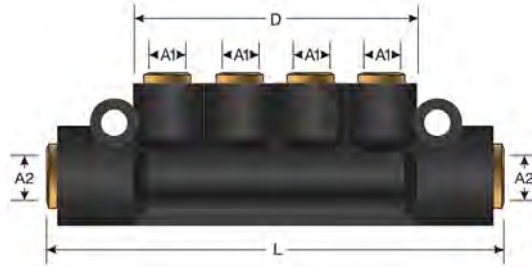

Part No.	Desc.	A1	A2	D Mounting Hole Length		L	
		"	"	"	mm	"	mm
G31970-0604	6AB-4MANIFOLD	3/8	1/4	2.76	70.10	4.10	104.1

Air Brake Union Y



Part No.	Desc.	A1	A2	A3	Standard Pack
		"	"	"	
G56975-0202	2SLI-2SLI-2SLI-Y	1/8	1/8	1/8	1
G56975-0404	4SLI-4SLI-4SLI-Y	1/4	1/4	1/4	1
G56975-2525	25SLI-25SLI-25SLI-Y	5/32	5/32	5/32	1

Air Brake Run Y to Male Pipe



Part No.	Desc.	A1	A2		Standard Pack
		"	"	T1 (in)	
G56978-0202	2MPX-2SLI-2SLI-Y	1/8	1/8	1/8-27	1
G56978-0204	2MPX-4SLI-4SLI-Y	1/4	1/4	1/8-27	1

- AIR BRAKE NYLON TUBING
- AIR BRAKE COPPER TUBING
- AIR BRAKE SURELOK
- COMPOSITE AIR BRAKE SURELOK
- AIR BRAKE COMPRESSION FITTINGS
- AIR BRAKE COUPLINGS FOR RUBBER HOSE
- VALVES
- BRASS LOCK-ON FIELD ATTACHABLE COUPLINGS
- SINGLE BEAD
- BARB STEM
- INVERTED FLARE
- AUTOMOTIVE ADAPTERS
- COPPER TUBING INDUSTRIAL COMPRESSION
- INDUSTRIAL SURELOK
- MINI-BARBED TUBE
- POLY INDUSTRIAL COMPRESSION
- PIPE ADAPTERS
- ADAPTERS SAE FLARE
- THREADED SLEEVE
- KITS & ASSORTMENTS

AIR BRAKE NYLON TUBING
AIR BRAKE COPPER TUBING
AIR BRAKE SURELOK
COMPOSITE AIR BRAKE SURELOK
AIR BRAKE COMPRESSION FITTINGS
AIR BRAKE COUPLINGS FOR RUBBER HOSE
VALVES
BRASS LOCK-ON FIELD ATTACHABLE COUPLINGS
SINGLE BEAD
BARB STEM
INVERTED FLARE
AUTOMOTIVE ADAPTERS
COPPER TUBING INDUSTRIAL COMPRESSION
INDUSTRIAL SURELOK
MINI-BARBED TUBE
POLY INDUSTRIAL COMPRESSION
PIPE ADAPTERS
ADAPTERS SAE FLARE
THREADED SLEEVE
KITS & ASSORTMENTS

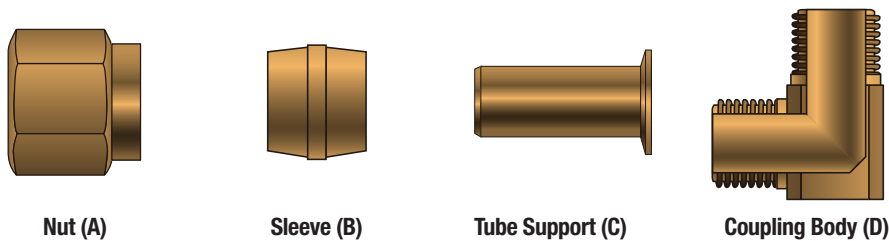

Tube O.D. (in)	1/4	3/8	1/2	5/8	3/4
Thread Size	7/16-24	9/16-24	11/16-20	13/16-18	1-18

Recommended For: Use in air brake systems - compressed air for suspension, steering, engine, transmission or other onboard vehicle applications. As a connector on all air brake systems at locations other than between chassis frame and axle or between towed and towing vehicle.

Used With: Nylon Tubing (SAE J844 or DIN 74324)

Features and Benefits: Easy to assemble, field serviceable fitting consisting of four component parts.

Conformance: Meets DOT FMVSS 571.106, SAE J246, SAE J1131, DIN 74324 and German TUV requirements.

Working Pressure: 150 psi (10 bar)

Temperature Range: -40°F to +200°F (-40°C to +93°C)

Material: 360 Brass

Assembly Instructions:

1. Ensure tubing end is cut straight, and free of burrs.
2. Slide nut "A" and then tube sleeve "B" onto tubing. The threaded end of nut "A" must face toward the coupling body "D".
3. Insert tube into the preassembled fitting until it bottoms in the coupling body "D".
4. Hand tighten nut onto fitting, mark nut and fitting as indicated in below diagrams.

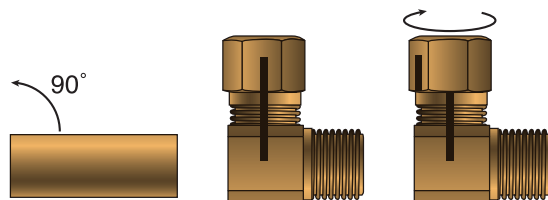

5. Using a wrench, continue tighten the connection by the number of turns indicated in the chart below.

Tube Size O.D. (in)	Turns from Hand Tight
1/4	3
3/8, 1/2, 5/8	4
3/4	3-1/2

Disassembly Instructions: Remove nut and pull the tubing out of coupling body "D". Insert will remain in tubing.

Reassembly Instructions: Push tubing and insert "C" into coupling body "D" until it bottoms, then thread nut "A" into coupling body "D" and torque per the chart below.

Tube Support Insert



Part No.	Desc.	A1	Standard Pack
		"	
G32040-0004	4TSI-ABC	1/4	1
G32040-0004B	4TSI-ABCB	1/4	10
G32040-0006	6TSI-ABC	3/8	1
G32040-0006B	6TSI-ABCB	3/8	10
G32040-0008	8TSI-ABC	1/2	1
G32040-0008B	8TSI-ABCB	1/2	5
G32040-0010	10TSI-ABC	5/8	1
G32040-0010B	10TSI-ABCB	5/8	5
G32040-0012	12TSI-ABC	3/4	1
G32040-0012B	12TSI-ABCB	3/4	5

Tube Sleeve

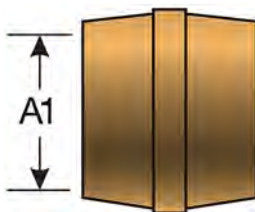

Part No.	Desc.	A1	Standard Pack
		"	
G32050-0004	4TS-ABC	1/4	10
G32050-0006	6TS-ABC	3/8	5
G32050-0008	8TS-ABC	1/2	1
G32050-0010	10TS-ABC	5/8	1
G32050-0012	12TS-ABC	3/4	1

Tube Sleeve Nut

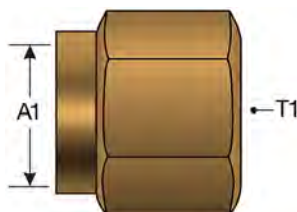

Part No.	Desc.	A1		Standard Pack
		"	T1 (in)	
G32060-0004	4TSN-ABC	1/4	7/16-24	10
G32060-0006	6TSN-ABC	3/8	17/32-24	5

AIR BRAKE
NYLON TUBING

AIR BRAKE
COPPER TUBING

AIR BRAKE
SURELOK

COMPOSITE AIR
BRAKE SURELOK

AIR BRAKE
COMPRESSION
FITTINGS

AIR BRAKE
COUPLINGS FOR
RUBBER HOSE

VALVES

BRASS LOCK-ON
FIELD
ATTACHABLE
COUPLINGS

SINGLE BEAD

BARB STEM

INVERTED FLARE

AUTOMOTIVE
ADAPTERS

COPPER TUBING
INDUSTRIAL
COMPRESSION

INDUSTRIAL
SURELOK

MINI-BARBED
TUBE

POLY
INDUSTRIAL
COMPRESSION

PIPE ADAPTERS

ADAPTERS SAE
FLARE

THREADED
SLEEVE

KITS &
ASSORTMENTS

Tube Sleeve Nut - Continued

Part No.	Desc.	A1		Standard Pack
		"	T1 (in)	
G32060-0008	8TSN-ABC	1/2	11/16-20	1
G32060-0010	10TSN-ABC	5/8	13/16-18	1
G32060-0012	12TSN-ABC	3/4	1-18	1

Air Brake to Male Pipe

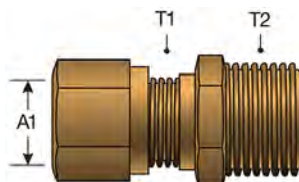

Part No.	Desc.	A1			Standard Pack
		"	T1 (in)	T2 (in)	
G32100-0401	4ABC-1MP	1/4	7/16-24	1/16-32	1
G32100-0402	4ABC-2MP	1/4	7/16-24	1/8-27	1
G32100-0404	4ABC-4MP	1/4	7/16-24	1/4-18	1
G32100-0406	4ABC-6MP	1/4	7/16-24	3/8-18	1
G32100-0602	6ABC-2MP	3/8	17/32-24	1/8-27	1
G32100-0604	6ABC-4MP	3/8	17/32-24	1/4-18	1
G32100-0606	6ABC-6MP	3/8	17/32-24	3/8-18	1
G32100-0608	6ABC-8MP	3/8	17/32-24	1/2-14	1
G32100-0804	8ABC-4MP	1/2	11/16-20	1/4-18	1
G32100-0806	8ABC-6MP	1/2	11/16-20	3/8-18	1
G32100-0808	8ABC-8MP	1/2	11/16-20	1/2-14	1
G32100-0812	8ABC-12MP	1/2	11/16-20	3/4-14	1
G32100-1006	10ABC-6MP	5/8	13/16-18	3/8-18	1
G32100-1008	10ABC-8MP	5/8	13/16-18	1/2-14	1
G32100-1012	10ABC-12MP	5/8	13/16-18	3/4-14	1
G32100-1208	12ABC-8MP	3/4	1-18	1/2-14	1
G32100-1212	12ABC-12MP	3/4	1-18	3/4-14	1

Air Brake to Male Pipe - 45°

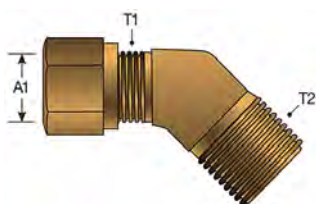



Part No.	Desc.	A1			Standard Pack
		"	T1 (in)	T2 (in)	
G32102-0402	4ABC-2MP45	1/4	7/16-24	1/8-27	1
G32102-0404	4ABC-4MP45	1/4	7/16-24	1/4-18	1
G32102-0602	6ABC-2MP45	3/8	17/32-24	1/8-27	1
G32102-0604	6ABC-4MP45	3/8	17/32-24	1/4-18	1

Air Brake to Male Pipe - 45° - Continued

Part No.	Desc.	A1			Standard Pack
		"	T1 (in)	T2 (in)	
G32102-0606	6ABC-6MP45	3/8	17/32-24	3/8-18	1
G32102-0608	6ABC-8MP45	3/8	17/32-24	1/2-14	1
G32102-0804	8ABC-4MP45	1/2	11/16-20	1/4-18	1
G32102-0806	8ABC-6MP45	1/2	11/16-20	3/8-18	1
G32102-0808	8ABC-8MP45	1/2	11/16-20	1/2-14	1
G32102-1008	10ABC-8MP45	5/8	13/16-18	1/2-14	1

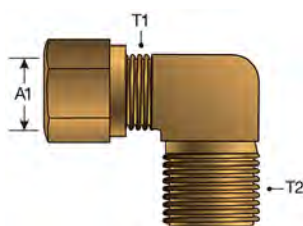
Air Brake to Male Pipe - 90°



Part No.	Desc.	A1			Standard Pack
		"	T1 (in)	T2 (in)	
G32104-0402	4ABC-2MP90	1/4	7/16-24	1/8-27	1
G32104-0404	4ABC-4MP90	1/4	7/16-24	1/4-18	1
G32104-0406	4ABC-6MP90	1/4	7/16-24	3/8-18	1
G32104-0602	6ABC-2MP90	3/8	17/32-24	1/8-27	1
G32104-0604	6ABC-4MP90	3/8	17/32-24	1/4-18	1
G32104-0606	6ABC-6MP90	3/8	17/32-24	3/8-18	1
G32104-0608	6ABC-8MP90	3/8	17/32-24	1/2-14	1
G32104-0804	8ABC-4MP90	1/2	11/16-20	1/4-18	1
G32104-0806	8ABC-6MP90	1/2	11/16-20	3/8-18	1
G32104-0808	8ABC-8MP90	1/2	11/16-20	1/2-14	1
G32104-1006	10ABC-6MP90	5/8	13/16-18	3/8-18	1
G32104-1008	10ABC-8MP90	5/8	13/16-18	1/2-14	1
G32104-1012	10ABC-12MP90	5/8	13/16-18	3/4-14	1
G32104-1206	12ABC-6MP90	3/4	1-18	3/8-18	1
G32104-1208	12ABC-8MP90	3/4	1-18	1/2-14	1
G32104-1212	12ABC-12MP90	3/4	1-18	3/4-14	1

AIR BRAKE
NYLON TUBING

AIR BRAKE
COPPER TUBING

AIR BRAKE
SURELOK

COMPOSITE AIR
BRAKE SURELOK

AIR BRAKE
COMPRESSION
FITTINGS

AIR BRAKE
COUPLINGS FOR
RUBBER HOSE

VALVES

BRASS LOCK-ON
FIELD
ATTACHABLE
COUPLINGS

SINGLE BEAD

BARB STEM

INVERTED FLARE

AUTOMOTIVE
ADAPTERS

COPPER TUBING
INDUSTRIAL
COMPRESSION

INDUSTRIAL
SURELOK

MINI-BARBED
TUBE

POLY
INDUSTRIAL
COMPRESSION

PIPE ADAPTERS

ADAPTERS SAE
FLARE

THREADED
SLEEVE

KITS &
ASSORTMENTS

- AIR BRAKE NYLON TUBING
- AIR BRAKE COPPER TUBING
- AIR BRAKE SURELOK
- COMPOSITE AIR BRAKE SURELOK
- AIR BRAKE COMPRESSION FITTINGS**
- AIR BRAKE COUPLINGS FOR RUBBER HOSE
- VALVES
- BRASS LOCK-ON FIELD ATTACHABLE COUPLINGS
- SINGLE BEAD
- BARB STEM
- INVERTED FLARE
- AUTOMOTIVE ADAPTERS
- COPPER TUBING INDUSTRIAL COMPRESSION
- INDUSTRIAL SURELOK
- MINI-BARBED TUBE
- POLY INDUSTRIAL COMPRESSION
- PIPE ADAPTERS
- ADAPTERS SAE FLARE
- THREADED SLEEVE
- KITS & ASSORTMENTS

Air Brake to Male Pipe - 90° - Long



Part No.	Desc.	A1			Standard Pack
		"	T1 (in)	T2 (in)	
G32106-0602	6ABC-2MP90L	3/8	17/32-24	1/8-27	1
G32106-0604	6ABC-4MP90L	3/8	17/32-24	1/4-18	1
G32106-0806	8ABC-6MP90L	1/2	11/16-20	3/8-18	1

Air Brake Run Tee to Male Pipe

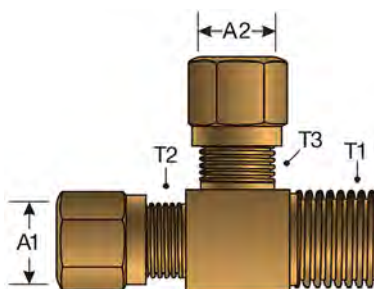

Part No.	Desc.	A1	A2				Standard Pack
		"	"	T1 (in)	T2 (in)	T3 (in)	
G32130-0204	2MP-4ABC-4ABC	1/4	1/4	1/8-27	7/16-24	7/16-24	1
G32130-0406	4MP-6ABC-6ABC	3/8	3/8	1/4-18	17/32-24	17/32-24	1
G32130-0606	6MP-6ABC-6ABC	3/8	3/8	3/8-18	17/32-24	17/32-24	1
G32130-0608	6MP-8ABC-8ABC	1/2	1/2	3/8-18	11/16-20	11/16-20	1
G32130-0808	8MP-8ABC-8ABC	1/2	1/2	1/2-14	11/16-20	11/16-20	1
G32130-0810	8MP-10ABC-10ABC	5/8	5/8	1/2-14	13/16-18	13/16-18	1
G32131-0406	4MP-4ABC-6ABC	1/4	3/8	1/4-18	7/16-24	17/32-24	1

Air Brake Branch Tee to Male Pipe

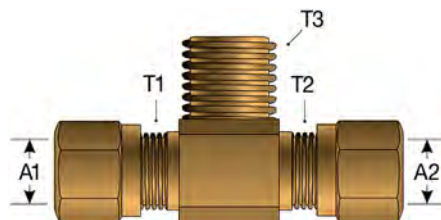

Part No.	Desc.	A1	A2				Standard Pack
		"	"	T1 (in)	T2 (in)	T3 (in)	
G32134-0402	4ABC-4ABC-2MP	1/4	1/4	7/16-24	7/16-24	1/8-27	1
G32134-0404	4ABC-4ABC-4MP	1/4	1/4	7/16-24	7/16-24	1/4-18	1
G32134-0602	6ABC-6ABC-2MP	3/8	3/8	17/32-24	17/32-24	1/8-27	1
G32134-0604	6ABC-6ABC-4MP	3/8	3/8	17/32-24	17/32-24	1/4-18	1
G32134-0606	6ABC-6ABC-6MP	3/8	3/8	17/32-24	17/32-24	3/8-18	1
G32134-0806	8ABC-8ABC-6MP	1/2	1/2	11/16-20	11/16-20	3/8-18	1
G32134-0808	8ABC-8ABC-8MP	1/2	1/2	11/16-20	11/16-20	1/2-14	1
G32134-1008	10ABC-10ABC-8MP	5/8	5/8	13/16-18	13/16-18	1/2-14	1
G32136-0604	6ABC-4ABC-4MP	3/8	1/4	17/32-24	7/16-24	1/4-18	1
G32136-0804	8ABC-8ABC-4MP	1/2	1/2	11/16-20	11/16-20	1/4-18	1
G32136-0806	8ABC-6ABC-6MP	1/2	3/8	11/16-20	17/32-24	3/8-18	1

Air Brake to Female Pipe

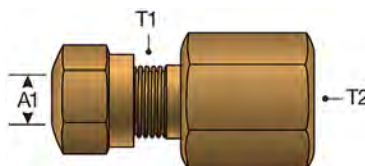

Part No.	Desc.	A1			Standard Pack
		"	T1 (in)	T2 (in)	
G32150-0402	4ABC-2FP	1/4	7/16-24	1/8-27	1
G32150-0404	4ABC-4FP	1/4	7/16-24	1/4-18	1
G32150-0602	6ABC-2FP	3/8	17/32-24	1/8-27	1
G32150-0604	6ABC-4FP	3/8	17/32-24	1/4-18	1
G32150-0606	6ABC-6FP	3/8	17/32-24	3/8-18	1
G32150-0806	8ABC-6FP	1/2	11/16-20	3/8-18	1
G32150-0808	8ABC-8FP	1/2	11/16-20	1/2-14	1
G32150-1006	10ABC-6FP	5/8	13/16-18	3/8-18	1
G32150-1008	10ABC-8FP	5/8	13/16-18	1/2-14	1
G32150-1208	12ABC-8FP	3/4	1-18	1/2-14	1

AIR BRAKE
NYLON TUBING

AIR BRAKE
COPPER TUBING

AIR BRAKE
SURELOK

COMPOSITE AIR
BRAKE SURELOK

AIR BRAKE
COMPRESSION
FITTINGS

AIR BRAKE
COUPLINGS FOR
RUBBER HOSE

VALVES

BRASS LOCK-ON
FIELD
ATTACHABLE
COUPLINGS

SINGLE BEAD

BARB STEM

INVERTED FLARE

AUTOMOTIVE
ADAPTERS

COPPER TUBING
INDUSTRIAL
COMPRESSION

INDUSTRIAL
SURELOK

MINI-BARBED
TUBE

POLY
INDUSTRIAL
COMPRESSION

PIPE ADAPTERS

ADAPTERS SAE
FLARE

THREADED
SLEEVE

KITS &
ASSORTMENTS

Air Brake to Female Pipe - 90°

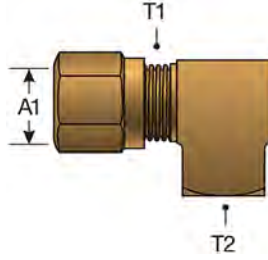

Part No.	Desc.	A1			Standard Pack
		"	T1 (in)	T2 (in)	
G32154-0402	4ABC-2FP90	1/4	7/16-24	1/8-27	1
G32154-0404	4ABC-4FP90	1/4	7/16-24	1/4-18	1
G32154-0602	6ABC-2FP90	3/8	17/32-24	1/8-27	1
G32154-0604	6ABC-4FP90	3/8	17/32-24	1/4-18	1
G32154-0606	6ABC-6FP90	3/8	17/32-24	3/8-18	1
G32154-0806	8ABC-6FP90	1/2	11/16-20	3/8-18	1
G32154-0808	8ABC-8FP90	1/2	11/16-20	1/2-14	1
G32154-1008	10ABC-8FP90	5/8	13/16-18	1/2-14	1

Air Brake Branch Tee to Female Pipe

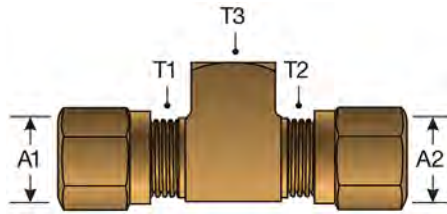

Part No.	Desc.	A1	A2				Standard Pack
		"	"	T1 (in)	T2 (in)	T3 (in)	
G32160-0604	6ABC-6ABC-4FP	3/8	3/8	17/32-24	17/32-24	1/4-18	1
G32160-0804	8ABC-8ABC-4FP	1/2	1/2	11/16-20	11/16-20	1/4-18	1
G32160-1004	10ABC-10ABC-4FP	5/8	5/8	13/16-18	13/16-18	1/4-18	1

Air Brake Bulkhead Union

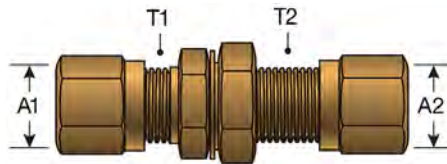



Part No.	Desc.	A1	A2			Standard Pack
		"	"	T1 (in)	T2 (in)	
G32300-0404	4ABC-4ABC-BKHD	1/4	1/4	7/16-24	7/16-24	1
G32300-0606	6ABC-6ABC-BKHD	3/8	3/8	17/32-24	17/32-24	1
G32300-0808	8ABC-8ABC-BKHD	1/2	1/2	11/16-20	11/16-20	1

Air Brake Bulkhead Union - Continued

Part No.	Desc.	A1	A2			Standard Pack
		"	"	T1 (in)	T2 (in)	
G32300-1010	10ABC-10ABC-BKHD	5/8	5/8	13/16-18	13/16-18	1

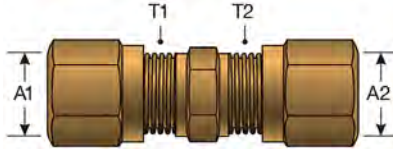
Air Brake Union



Part No.	Desc.	A1	A2			Standard Pack
		"	"	T1 (in)	T2 (in)	
G32400-0404	4ABC-4ABC	1/4	1/4	7/16-24	7/16-24	1
G32400-0606	6ABC-6ABC	3/8	3/8	17/32-24	17/32-24	1
G32400-0808	8ABC-8ABC	1/2	1/2	11/16-20	11/16-20	1
G32400-1010	10ABC-10ABC	5/8	5/8	13/16-18	13/16-18	1
G32400-1212	12ABC-12ABC	3/4	3/4	1-18	1-18	1

Air Brake Union - 90°

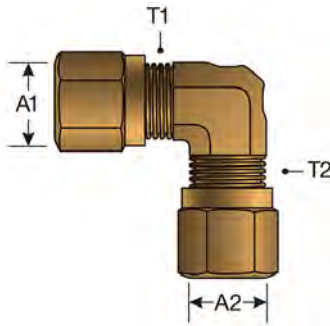

Part No.	Desc.	A1	A2			Standard Pack
		"	"	T1 (in)	T2 (in)	
G32404-0404	4ABC-4ABC90	1/4	1/4	7/16-24	7/16-24	1
G32404-0606	6ABC-6ABC90	3/8	3/8	17/32-24	17/32-24	1
G32404-0808	8ABC-8ABC90	1/2	1/2	11/16-20	11/16-20	1
G32404-1010	10ABC-10ABC90	5/8	5/8	13/16-18	13/16-18	1

- AIR BRAKE NYLON TUBING
- AIR BRAKE COPPER TUBING
- AIR BRAKE SURELOK
- COMPOSITE AIR BRAKE SURELOK
- AIR BRAKE COMPRESSION FITTINGS
- AIR BRAKE COUPLINGS FOR RUBBER HOSE
- VALVES
- BRASS LOCK-ON FIELD ATTACHABLE COUPLINGS
- SINGLE BEAD
- BARB STEM
- INVERTED FLARE
- AUTOMOTIVE ADAPTERS
- COPPER TUBING INDUSTRIAL COMPRESSION
- INDUSTRIAL SURELOK
- MINI-BARBED TUBE
- POLY INDUSTRIAL COMPRESSION
- PIPE ADAPTERS
- ADAPTERS SAE FLARE
- THREADED SLEEVE
- KITS & ASSORTMENTS

Air Brake Union - Tee

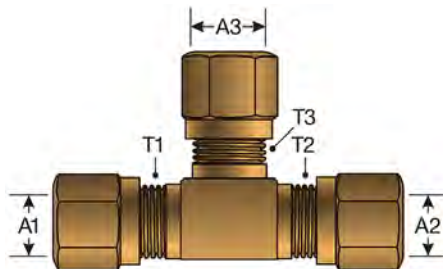

Part No.	Desc.	A1	A2	A3				Standard Pack
		"	"	"	T1 (in)	T2 (in)	T3 (in)	
G32450-0404	4ABC-4ABC-4ABC	1/4	1/4	1/4	7/16-24	7/16-24	7/16-24	1
G32450-0406	4ABC-6ABC-6ABC	1/4	3/8	3/8	7/16-24	17/32-24	17/32-24	1
G32450-0604	6ABC-6ABC-4ABC	3/8	3/8	1/4	17/32-24	17/32-24	7/16-24	1
G32450-0606	6ABC-6ABC-6ABC	3/8	3/8	3/8	17/32-24	17/32-24	17/32-24	1
G32450-0608	6ABC-6ABC-8ABC	3/8	3/8	1/2	17/32-24	17/32-24	11/16-20	1
G32450-0806	8ABC-8ABC-6ABC	1/2	1/2	3/8	11/16-20	11/16-20	17/32-24	1
G32450-0808	8ABC-8ABC-8ABC	1/2	1/2	1/2	11/16-20	11/16-20	11/16-20	1
G32450-1010	10ABC-10ABC-10ABC	5/8	5/8	5/8	13/16-18	13/16-18	13/16-18	1
G32452-0806	8ABC-6ABC-8ABC	1/2	3/8	1/2	11/16-20	17/32-24	11/16-20	1

- AIR BRAKE NYLON TUBING
- AIR BRAKE COPPER TUBING
- AIR BRAKE SURELOK
- COMPOSITE AIR BRAKE SURELOK
- AIR BRAKE COMPRESSION FITTINGS
- AIR BRAKE COUPLINGS FOR RUBBER HOSE
- VALVES
- BRASS LOCK-ON FIELD ATTACHABLE COUPLINGS
- SINGLE BEAD
- BARB STEM
- INVERTED FLARE
- AUTOMOTIVE ADAPTERS
- COPPER TUBING INDUSTRIAL COMPRESSION
- INDUSTRIAL SURELOK
- MINI-BARBED TUBE
- POLY INDUSTRIAL COMPRESSION
- PIPE ADAPTERS
- ADAPTERS SAE FLARE
- THREADED SLEEVE
- KITS & ASSORTMENTS

Air Brake Couplings For Rubber Hose

Recommended For: Air brake systems on trucks and buses. Offering includes a broad range of application coverage for use in the air brake system and with AB Series Rubber Air Brake Hose.

Used With: AB Series Rubber Air Brake Hose. **NOT** recommended for Nylon Air Brake Tubing.

Features and Benefits: Many fittings can be detached and reattached for reuse.

Conformance: Meets SAE J1402 and D.O.T. FMVSS-106 requirements.

Working Pressure: 225 psi (15 bar)

Maximum Burst Pressure: 900 psi (62 bar)

Temperature Range: -63°F to +250°F (-52° to +121°C)

Material: 360 Brass

AIR BRAKE
NYLON TUBING

AIR BRAKE
COPPER TUBING

AIR BRAKE
SURELOK

COMPOSITE AIR
BRAKE SURELOK

AIR BRAKE
COMPRESSION
FITTINGS

AIR BRAKE
COUPLINGS FOR
RUBBER HOSE

VALVES

BRASS LOCK-ON
FIELD
ATTACHABLE
COUPLINGS

SINGLE BEAD

BARB STEM

INVERTED FLARE

AUTOMOTIVE
ADAPTERS

COPPER TUBING
INDUSTRIAL
COMPRESSION

INDUSTRIAL
SURELOK

MINI-BARBED
TUBE

POLY
INDUSTRIAL
COMPRESSION

PIPE ADAPTERS

ADAPTERS SAE
FLARE

THREADED
SLEEVE

KITS &
ASSORTMENTS

Male Air Brake to Male Pipe Adapter

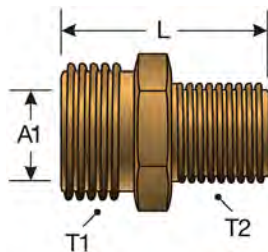

Part No.	Desc.	A1				L		Standard Pack
		"	mm	T1 (in)	T2 (in)	"	mm	
G33030-0604	6MAB-4MP	3/8	9.7	3/4-20	1/4-18	1.06	26.9	1
G33030-0606	6MAB-6MP	3/8	9.7	3/4-20	3/8-18	1.12	28.5	1
G33030-0608	6MAB-8MP	3/8	9.7	3/4-20	1/2-14	1.18	30.0	1
G33030-0806	8MAB-6MP	1/2	12.7	7/8-20	3/8-18	1.18	30.0	1
G33030-0808	8MAB-8MP	1/2	12.7	7/8-20	1/2-14	1.37	34.8	1

Gladhand

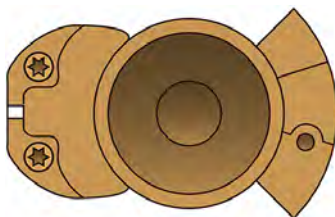

Part No.	Desc.	Type	Standard Pack
G33031-0508	8GH-S	Service	1
G33031-0608	8GH-U	Universal	1
G33031-0708	8GH-E	Emergency	1

Gladhand Seal



Part No.	Desc.	Standard Pack
G33032-0006	6GH-SEAL	1

Sleeve

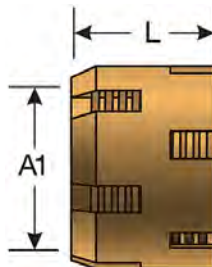

Part No.	Desc.	A1		L		Standard Pack
		"	mm	"	mm	
G33050-0006	6TS-6ABR	3/8	9.7	.69	17.5	1
G33050-0008	8TS-8ABR	1/2	12.7	.69	17.5	1

Nut

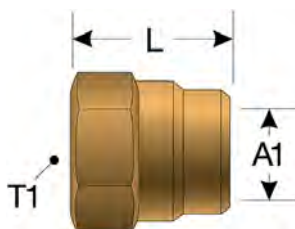

Part No.	Desc.	A1		T1 (in)	L		Standard Pack
		"	mm		"	mm	
G33060-0006	6TSN-6ABR	3/8	9.7	1 1/16	1.12	28.5	1
G33060-0008	8TSN-8ABR	1/2	12.7	1 1/4	1.12	28.5	1

Spring Guard Nut

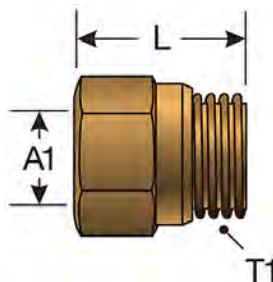

Part No.	Desc.	A1		T1 (in)	L		Standard Pack
		"	mm		"	mm	
G33061-0006	6SGN-6ABR	3/8	9.7	1 1/16	1.22	31.0	1
G33061-0008	8SGN-8ABR	1/2	12.7	1 1/4	1.19	30.2	1

AIR BRAKE NYLON TUBING

AIR BRAKE COPPER TUBING

AIR BRAKE SURELOK

COMPOSITE AIR BRAKE SURELOK

AIR BRAKE COMPRESSION FITTINGS

AIR BRAKE COUPLINGS FOR RUBBER HOSE

VALVES

BRASS LOCK-ON FIELD ATTACHABLE COUPLINGS

SINGLE BEAD

BARB STEM

INVERTED FLARE

AUTOMOTIVE ADAPTERS

COPPER TUBING INDUSTRIAL COMPRESSION

INDUSTRIAL SURELOK

MINI-BARBED TUBE

POLY INDUSTRIAL COMPRESSION

PIPE ADAPTERS

ADAPTERS SAE FLARE

THREADED SLEEVE

KITS & ASSORTMENTS

- AIR BRAKE NYLON TUBING
- AIR BRAKE COPPER TUBING
- AIR BRAKE SURELOK
- COMPOSITE AIR BRAKE SURELOK
- AIR BRAKE COMPRESSION FITTINGS
- AIR BRAKE COUPLINGS FOR RUBBER HOSE**
- VALVES
- BRASS LOCK-ON FIELD ATTACHABLE COUPLINGS
- SINGLE BEAD
- BARB STEM
- INVERTED FLARE
- AUTOMOTIVE ADAPTERS
- COPPER TUBING INDUSTRIAL COMPRESSION
- INDUSTRIAL SURELOK
- MINI-BARBED TUBE
- POLY INDUSTRIAL COMPRESSION
- PIPE ADAPTERS
- ADAPTERS SAE FLARE
- THREADED SLEEVE
- KITS & ASSORTMENTS

Air Brake to Male Pipe with Nut and Sleeve

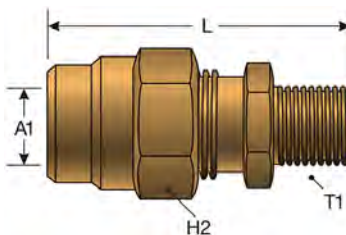

Part No.	Desc.	A1			H2	L		Standard Pack
		"	mm	T1 (in)	"	"	mm	
G33100-0604	6ABR-4MP	3/8	9.7	1/4-18	31/32	2.12	53.9	1
G33100-0606	6ABR-6MP	3/8	9.7	3/8-18	31/32	2.12	53.9	1
G33100-0608	6ABR-8MP	3/8	9.7	1/2-14	31/32	2.27	57.7	1
G33100-0806	8ABR-6MP	1/2	12.7	3/8-18	1 1/8	2.13	54.1	1
G33100-0808	8ABR-8MP	1/2	12.7	1/2-14	1 1/8	2.29	58.2	1

Air Brake to Male Pipe with Spring Guard

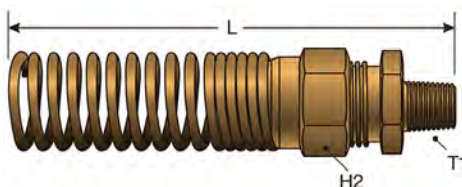

Part No.	Desc.		H2	L		Standard Pack
		T1 (in)	"	"	mm	
G33110-0604	6ABRSG-4MP	1/4-18	31/32	4.80	121.9	1
G33110-0606	6ABRSG-6MP	3/8-18	31/32	4.80	121.9	1
G33110-0608	6ABRSG-8MP	1/2-14	31/32	4.90	124.5	1
G33110-0806	8ABRSG-6MP	3/8-18	1 1/8	5.00	127.0	1
G33110-0808	8ABRSG-8MP	1/2-14	1 1/8	5.20	132.1	1

Air Brake to Male Pipe without Nut and Sleeve

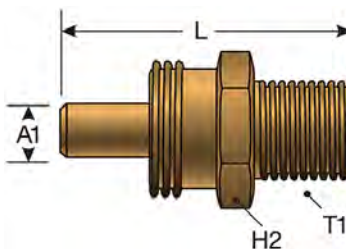

Part No.	Desc.	A1			H2	L		Standard Pack
		"	mm	T1 (in)	"	"	mm	
G33111-0604	6ABRI-4MP	3/8	9.7	1/4-18	31/32	1.91	48.5	1
G33111-0606	6ABRI-6MP	3/8	9.7	3/8-18	31/32	1.91	48.5	1
G33111-0608	6ABRI-8MP	3/8	9.7	1/2-14	31/32	2.06	52.3	1

Air Brake to Male Pipe without Nut and Sleeve - Continued

Part No.	Desc.	A1			H2	L		Standard Pack
		"	mm	T1 (in)	"	"	mm	
G33111-0806	8ABRI-6MP	1/2	12.7	3/8-18	1 1/8	1.90	48.3	1
G33111-0808	8ABRI-8MP	1/2	12.7	1/2-14	1 1/8	2.07	52.6	1

Air Brake Spring Guard

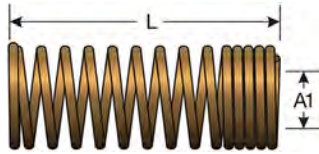

Part No.	Desc.	A1		L		Standard Pack
		"	mm	"	mm	
G33112-0006	6SGABR	3/8	9.7	2.75	69.9	1
G33112-0008	8SGABR	1/2	12.7	3.00	76.2	1

Air Brake to Female Air Brake Swivel

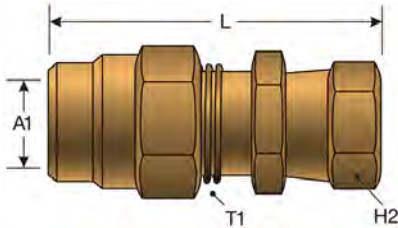

Part No.	Desc.	A1			H2	L		Standard Pack
		"	mm	T1 (in)	"	"	mm	
G33150-0606	6ABR-6FABX	3/8	9.7	3/4-20	31/32	2.30	58.4	1
G33150-0808	8ABR-8FABX	1/2	12.7	7/8-20	1 1/8	2.36	59.9	1

Air Brake to Female Air Brake Swivel with Adapter

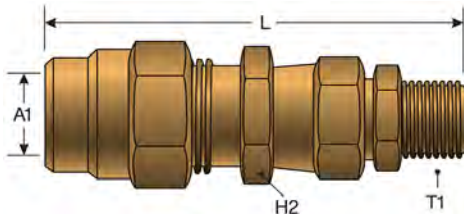

Part No.	Desc.	A1			H2	L		Standard Pack
		"	mm	T1 (in)	"	"	mm	
G33151-0604	6ABR-6FABX-4MPA	3/8	9.7	1/4-18	15/16	2.94	74.7	1
G33151-0606	6ABR-6FABX-6MPA	3/8	9.7	3/8-18	1 1/8	2.94	74.7	1

- AIR BRAKE NYLON TUBING
- AIR BRAKE COPPER TUBING
- AIR BRAKE SURELOK
- COMPOSITE AIR BRAKE SURELOK
- AIR BRAKE COMPRESSION FITTINGS
- AIR BRAKE COUPLINGS FOR RUBBER HOSE
- VALVES
- BRASS LOCK-ON FIELD ATTACHABLE COUPLINGS
- SINGLE BEAD
- BARB STEM
- INVERTED FLARE
- AUTOMOTIVE ADAPTERS
- COPPER TUBING INDUSTRIAL COMPRESSION
- INDUSTRIAL SURELOK
- MINI-BARBED TUBE
- POLY INDUSTRIAL COMPRESSION
- PIPE ADAPTERS
- ADAPTERS SAE FLARE
- THREADED SLEEVE
- KITS & ASSORTMENTS

Air Brake to Female Air Brake Swivel with Adapter - Continued

Part No.	Desc.	A1		T1 (in)	H2	L		Standard Pack
		"	mm			"	mm	
G33151-0608	6ABR-8FABX-8MPA	3/8	9.7	1/2-14	1 1/8	2.94	74.7	1
G33151-0806	8ABR-6FABX-6MPA	1/2	12.7	3/8-18	1 1/8	2.94	74.7	1

Air Brake Union

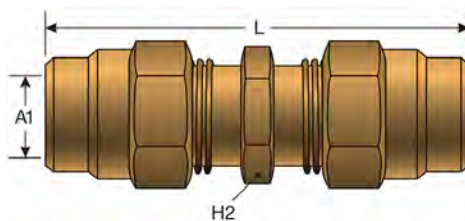

Part No.	Desc.	A1		H2	L		Standard Pack
		"	mm		"	mm	
G33400-0606	6ABR-6ABR	3/8	9.7	31/32	2.98	75.7	1
G33400-0808	8ABR-8ABR	1/2	12.7	1 1/8	2.99	75.9	1

- AIR BRAKE NYLON TUBING
- AIR BRAKE COPPER TUBING
- AIR BRAKE SURELOK
- COMPOSITE AIR BRAKE SURELOK
- AIR BRAKE COMPRESSION FITTINGS
- AIR BRAKE COUPLINGS FOR RUBBER HOSE
- VALVES
- BRASS LOCK-ON FIELD ATTACHABLE COUPLINGS
- SINGLE BEAD
- BARB STEM
- INVERTED FLARE
- AUTOMOTIVE ADAPTERS
- COPPER TUBING INDUSTRIAL COMPRESSION
- INDUSTRIAL SURELOK
- MINI-BARBED TUBE
- POLY INDUSTRIAL COMPRESSION
- PIPE ADAPTERS
- ADAPTERS SAE FLARE
- THREADED SLEEVE
- KITS & ASSORTMENTS

Recommended For: Oil, coolant and water. Commonly used for fuel line connections in heavy-duty truck and trailer applications.

Used With: Copper, aluminum, steel and plastic tubing

Features and Benefits: Robust construction with metal to metal seats for high heat and fluid compatibility. A fine thread screw provides easy adjustment and flow control.

Conformance: Recommended for fleet, heavy-duty or industrial use. Not recommended for natural gas or LPG applications.

Working Pressure: 150 psi (10 bar)

Temperature Range: -30°F to +250°F (-34°C to +121°C)

Material: 360 Brass

Assembly Instructions:

1. Be sure to apply pressure against the seat of the valve during installation.
2. When installing angle valves, pressure should always be directed against the seat, not the stem threads of the valve.

AIR BRAKE NYLON TUBING
AIR BRAKE COPPER TUBING
AIR BRAKE SURELOK
COMPOSITE AIR BRAKE SURELOK
AIR BRAKE COMPRESSION FITTINGS
AIR BRAKE COUPLINGS FOR RUBBER HOSE
VALVES
BRASS LOCK-ON FIELD ATTACHABLE COUPLINGS
SINGLE BEAD
BARB STEM
INVERTED FLARE
AUTOMOTIVE ADAPTERS
COPPER TUBING INDUSTRIAL COMPRESSION
INDUSTRIAL SURELOK
MINI-BARBED TUBE
POLY INDUSTRIAL COMPRESSION
PIPE ADAPTERS
ADAPTERS SAE FLARE
THREADED SLEEVE
KITS & ASSORTMENTS

Truck Valve 90° - Air Brake Nylon Compression to Male Pipe Branch

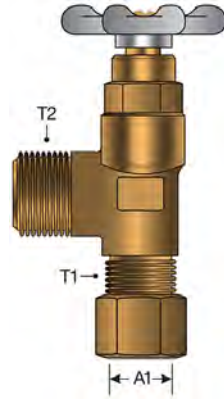

Part No.	Desc.	A1			Standard Pack
		"	T1 (in)	T2 (in)	
G32601-0808	8ABC-8MP90-TV	1/2	11/16-20	1/2-14	1

Truck Valve 90° - Air Brake Nylon Compression to Male Pipe Run

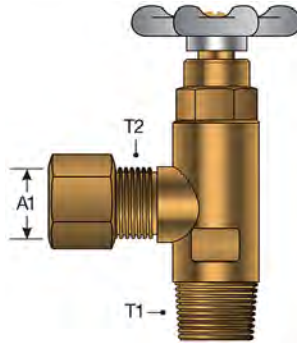

Part No.	Desc.	A1			Standard Pack
		"	T1 (in)	T2 (in)	
G32602-0808	8MP-8ABC90-TV	1/2	1/2-14	11/16-20	1

- AIR BRAKE NYLON TUBING
- AIR BRAKE COPPER TUBING
- AIR BRAKE SURELOK
- COMPOSITE AIR BRAKE SURELOK
- AIR BRAKE COMPRESSION FITTINGS
- AIR BRAKE COUPLINGS FOR RUBBER HOSE
- VALVES**
- BRASS LOCK-ON FIELD ATTACHABLE COUPLINGS
- SINGLE BEAD
- BARB STEM
- INVERTED FLARE
- AUTOMOTIVE ADAPTERS
- COPPER TUBING INDUSTRIAL COMPRESSION
- INDUSTRIAL SURELOK
- MINI-BARBED TUBE
- POLY INDUSTRIAL COMPRESSION
- PIPE ADAPTERS
- ADAPTERS SAE FLARE
- THREADED SLEEVE
- KITS & ASSORTMENTS

Air Tank Drain Valve

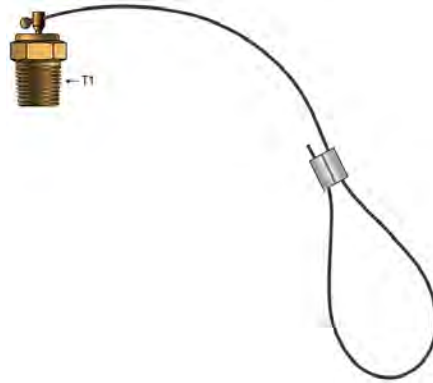

Part No.	Desc.		Standard Pack
		T1 (in)	
G33021-0004	4MP-ATDV	1/4-18	1

Air Vent

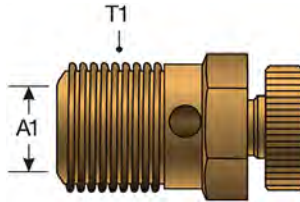

Part No.	Desc.	A1		Standard Pack
		"	T1 (in)	
G33022-0002	2MP-AV	1/8	1/8-27	1

One Way Check Valve

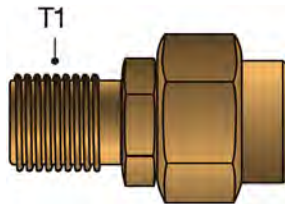

Part No.	Desc.		Standard Pack
		T1 (in)	
G33027-0006	6MP-CV	3/8-18	1
G33027-0008	8MP-CV	1/2-14	1

- AIR BRAKE NYLON TUBING
- AIR BRAKE COPPER TUBING
- AIR BRAKE SURELOK
- COMPOSITE AIR BRAKE SURELOK
- AIR BRAKE COMPRESSION FITTINGS
- AIR BRAKE COUPLINGS FOR RUBBER HOSE
- VALVES**
- BRASS LOCK-ON FIELD ATTACHABLE COUPLINGS
- SINGLE BEAD
- BARB STEM
- INVERTED FLARE
- AUTOMOTIVE ADAPTERS
- COPPER TUBING INDUSTRIAL COMPRESSION
- INDUSTRIAL SURELOK
- MINI-BARBED TUBE
- POLY INDUSTRIAL COMPRESSION
- PIPE ADAPTERS
- ADAPTERS SAE FLARE
- THREADED SLEEVE
- KITS & ASSORTMENTS

Truck Valve 90° - Male SAE 45° Flare to Male Pipe Run

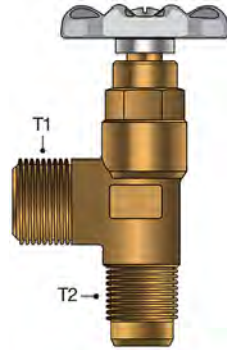

Part No.	Desc.			Standard Pack
		T1 (in)	T2 (in)	
G33610-0810	8MP-10MS90-TV	1/2-14	7/8-14	1

Truck Valve 90° - Male SAE 45° to Male Pipe Branch

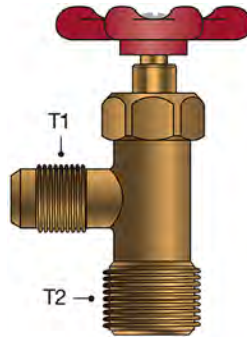

Part No.	Desc.			Standard Pack
		T1 (in)	T2 (in)	
G33612-0604	6MS-4MP90-TV	5/8-18	1/4-18	1
G33612-0606	6MS-6MP90-TV	5/8-18	3/8-18	1
G33612-0608	6MS-8MP90-TV	5/8-18	1/2-14	1
G33612-0806	8MS-6MP90-TV	3/4-16	3/8-18	1
G33612-0808	8MS-8MP90-TV	3/4-16	1/2-14	1
G33612-1008	10MS-8MP90-TV	7/8-14	1/2-14	1
G33612-1208	12MS-8MP90-TV	1 1/16-14	1/2-14	1

Truck Valve 90° - Single Bead to Male Pipe Run

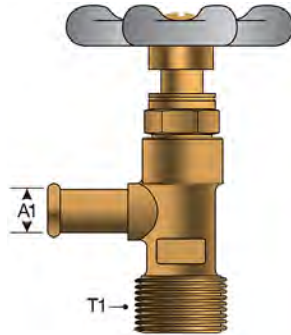

Part No.	Desc.	A1		Standard Pack
		"	T1 (in)	
G33620-0606	6SB-6MP90-TV	3/8	3/8-18	1
G33620-0806	8SB-6MP90-TV	1/2	3/8-18	1
G33620-1006	10SB-6MP90-TV	5/8	3/8-18	1
G33620-1008	10SB-8MP90-TV	5/8	1/2-14	1
G33620-1206	12SB-6MP90-TV	3/4	3/8-18	1
G33620-1208	12SB-8MP90-TV	3/4	1/2-14	1

Truck Valve 90° - Barbed to Male Pipe Branch with Pin Handle

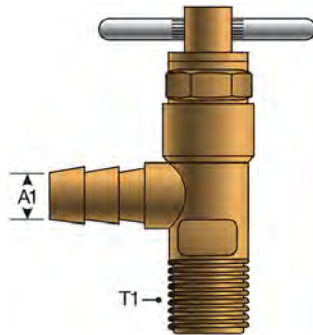

Part No.	Desc.	A1		Standard Pack
		"	T1 (in)	
G33622-0606	6SB-6MP90-TVP	3/8	3/8-18	1
G33622-1006	10SB-6MP90-TVP	5/8	3/8-18	1

- AIR BRAKE NYLON TUBING
- AIR BRAKE COPPER TUBING
- AIR BRAKE SURELOK
- COMPOSITE AIR BRAKE SURELOK
- AIR BRAKE COMPRESSION FITTINGS
- AIR BRAKE COUPLINGS FOR RUBBER HOSE
- VALVES**
- BRASS LOCK-ON FIELD ATTACHABLE COUPLINGS
- SINGLE BEAD
- BARB STEM
- INVERTED FLARE
- AUTOMOTIVE ADAPTERS
- COPPER TUBING INDUSTRIAL COMPRESSION
- INDUSTRIAL SURELOK
- MINI-BARBED TUBE
- POLY INDUSTRIAL COMPRESSION
- PIPE ADAPTERS
- ADAPTERS SAE FLARE
- THREADED SLEEVE
- KITS & ASSORTMENTS

Truck Valve 90° - Male Pipe to Female Pipe Branch

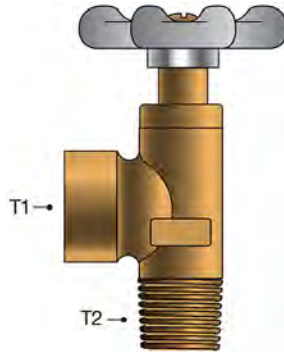

Part No.	Desc.			Standard Pack
		T1 (in)	T2 (in)	
G33630-0606	6FP-6MP90-TV	3/8-18	3/8-18	1
G33630-0608	6FP-8MP90-TV	3/8-18	1/2-14	1
G33630-0808	8FP-8MP90-TV	1/2-14	1/2-14	1

Truck Valve - 3-Way

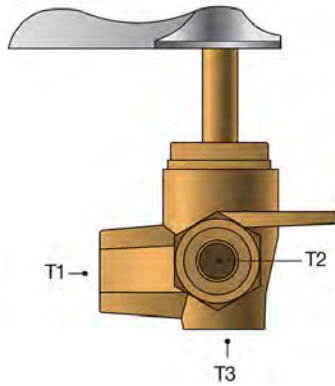

Part No.	Desc.				Standard Pack
		T1 (in)	T2 (in)	T3 (in)	
G33650-0202	2FP-2FP-2FP3WTV	1/8-27	1/8-27	1/8-27	1
G33650-0404	4FP-4FP-4FP3WTV	1/4-18	1/4-18	1/4-18	1
G33650-0606	6FP-6FP-6FP3WTV	3/8-18	3/8-18	3/8-18	1

Truck Valve - 4-Way

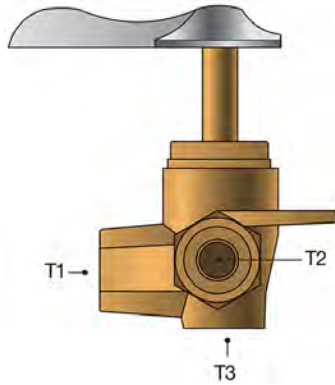

Part No.	Desc.	Tubing			Standard Pack
		T1 (in)	T2 (in)	T3 (in)	
G33655-0404	4FP-4FP-4FP4WTV	1/4-18	1/4-18	1/4-18	1
G33655-0606	6FP-6FP-6FP4WTV	3/8-18	3/8-18	3/8-18	1
G33656-0404	4FP-4FP-4FP4WTV-L	1/4-18	1/4-18	1/4-18	1
G33656-0606	6FP-6FP-6FP4WTV-L	3/8-18	3/8-18	3/8-18	1

Shut-Off Cock - Copper Tubing Ind. Compression to Copper Tubing Ind. Compression Run

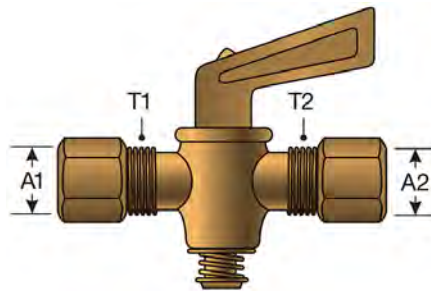

Part No.	Desc.	A1	A2	Tubing		Standard Pack
		"	"	T1 (in)	T2 (in)	
G33701-0404	4MFA-4MFASC	1/4	1/4	7/16-24	7/16-24	1
G33701-0505	5MFA-5MFASC	5/16	5/16	1/2-24	1/2-24	1
G33701-0606	6MFA-6MFASC	3/8	3/8	9/16-24	9/16-24	1
G33701-0808	8MFA-8MFASC	1/2	1/2	11/16-20	11/16-20	1

- AIR BRAKE NYLON TUBING
- AIR BRAKE COPPER TUBING
- AIR BRAKE SURELOK
- COMPOSITE AIR BRAKE SURELOK
- AIR BRAKE COMPRESSION FITTINGS
- AIR BRAKE COUPLINGS FOR RUBBER HOSE
- VALVES**
- BRASS LOCK-ON FIELD ATTACHABLE COUPLINGS
- SINGLE BEAD
- BARB STEM
- INVERTED FLARE
- AUTOMOTIVE ADAPTERS
- COPPER TUBING INDUSTRIAL COMPRESSION
- INDUSTRIAL SURELOK
- MINI-BARBED TUBE
- POLY INDUSTRIAL COMPRESSION
- PIPE ADAPTERS
- ADAPTERS SAE FLARE
- THREADED SLEEVE
- KITS & ASSORTMENTS

Shut-Off Cock - Copper Tubing Industrial Compression to Male Pipe Run

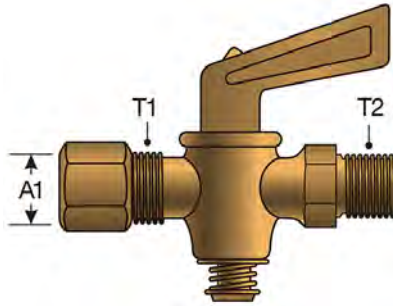

Part No.	Desc.	A1	🌀		Standard Pack
			T1 (in)	T2 (in)	
G33705-0402	4MFA-2MPSC	1/4	7/16-24	1/8-27	1
G33705-0404	4MFA-4MPSC	1/4	7/16-24	1/4-18	1
G33705-0502	5MFA-2MPSC	5/16	1/2-24	1/8-27	1
G33705-0504	5MFA-4MPSC	5/16	1/2-24	1/4-18	1
G33705-0604	6MFA-4MPSC	3/8	9/16-24	1/4-18	1
G33705-0806	8MFA-6MPSC	1/2	11/16-20	3/8-18	1

Shut-Off Cock - Male Pipe to Female Pipe Run

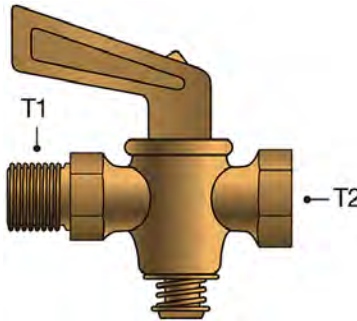

Part No.	Desc.	🌀		Standard Pack
		T1 (in)	T2 (in)	
G33710-0202	2MP-2FPSC	1/8-27	1/8-27	1
G33710-0404	4MP-4FPSC	1/4-18	1/4-18	1
G33710-0606	6MP-6FPSC	3/8-18	3/8-18	1
G33710-0808	8MP-8FPSC	1/2-14	1/2-14	1

Shut-Off Cock - Female Pipe to Female Pipe Run

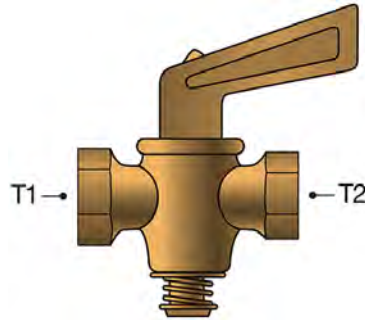

Part No.	Desc.	Spring		Standard Pack
		T1 (in)	T2 (in)	
G33715-0202	2FP-2FPSC	1/8-27	1/8-27	1
G33715-0404	4FP-4FPSC	1/4-18	1/4-18	1
G33715-0606	6FP-6FPSC	3/8-18	3/8-18	1
G33715-0808	8FP-8FPSC	1/2-14	1/2-14	1

Shut-Off Cock - Male SAE 45° Flare to Male Pipe Run

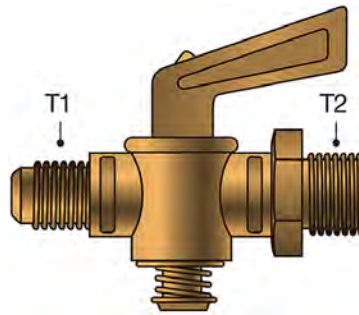

Part No.	Desc.	Spring		Standard Pack
		T1 (in)	T2 (in)	
G33720-0402	4MS-2MPSC	7/16-20	1/8-27	1
G33720-0404	4MS-4MPSC	7/16-20	1/4-18	1
G33720-0502	5MS-2MPSC	1/2-20	1/8-27	1
G33720-0504	5MS-4MPSC	1/2-20	1/4-18	1
G33720-0604	6MS-4MPSC	5/8-18	1/4-18	1
G33720-0606	6MS-6MPSC	5/8-18	3/8-18	1
G33720-0608	6MS-8MPSC	5/8-18	1/2-14	1
G33720-0806	8MS-6MPSC	3/4-16	3/8-18	1
G33720-0808	8MS-8MPSC	3/4-16	1/2-14	1

- AIR BRAKE NYLON TUBING
- AIR BRAKE COPPER TUBING
- AIR BRAKE SURELOK
- COMPOSITE AIR BRAKE SURELOK
- AIR BRAKE COMPRESSION FITTINGS
- AIR BRAKE COUPLINGS FOR RUBBER HOSE
- VALVES**
- BRASS LOCK-ON FIELD ATTACHABLE COUPLINGS
- SINGLE BEAD
- BARB STEM
- INVERTED FLARE
- AUTOMOTIVE ADAPTERS
- COPPER TUBING INDUSTRIAL COMPRESSION
- INDUSTRIAL SURELOK
- MINI-BARBED TUBE
- POLY INDUSTRIAL COMPRESSION
- PIPE ADAPTERS
- ADAPTERS SAE FLARE
- THREADED SLEEVE
- KITS & ASSORTMENTS

Shut-Off Cock - Male SAE 45° Flare to Male SAE 45° Flare Run

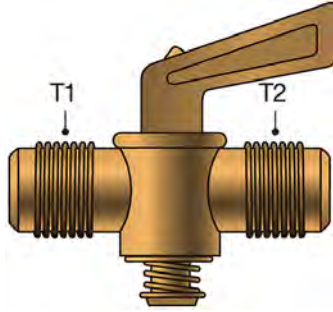

Part No.	Desc.			Standard Pack
		T1 (in)	T2 (in)	
G33730-0404	4MS-4MSSC	7/16-20	7/16-20	1
G33730-0505	5MS-5MSSC	1/2-20	1/2-20	1
G33730-0606	6MS-6MSSC	5/8-18	5/8-18	1
G33730-0808	8MS-8MSSC	3/4-16	3/4-16	1
G33730-1010	10MS-10MSSC	7/8-14	7/8-14	1

Air Shut-Off Cock - Male Pipe to Bibb Nose

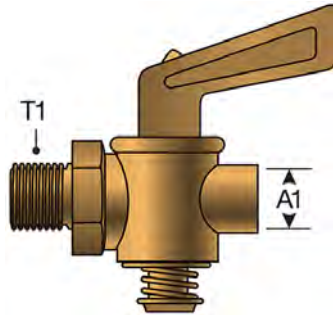

Part No.	Desc.	A1		Standard Pack
		"	T1 (in)	
G33801-0002	2MP-ADC	1/8	1/8-27	1
G33801-0004	4MP-ADC	1/4	1/4-18	1
G33801-0006	6MP-ADC	3/8	3/8-18	1
G33801-0008	8MP-ADC	1/2	1/2-14	1

Air Drain Cock - Male Pipe to Female Pipe

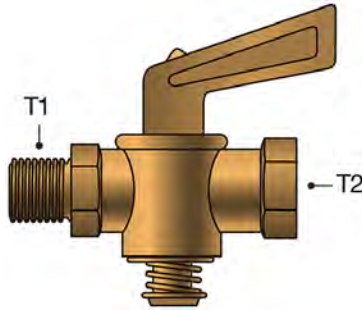

Part No.	Desc.			Standard Pack
		T1 (in)	T2 (in)	
G33805-0202	2FP-2MPADC	1/8-27	1/8-27	1
G33805-0404	4FP-4MPADC	1/4-18	1/4-18	1
G33805-0808	8FP-8MPADC	1/2-14	1/2-14	1

Drain Cock 90° - Single Bead to Male Pipe - Long

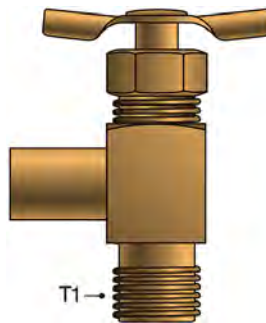

Part No.	Desc.		Standard Pack
		T1 (in)	
G33823-1006	10BN-6MPDC90	3/8-18	1

- AIR BRAKE NYLON TUBING
- AIR BRAKE COPPER TUBING
- AIR BRAKE SURELOK
- COMPOSITE AIR BRAKE SURELOK
- AIR BRAKE COMPRESSION FITTINGS
- AIR BRAKE COUPLINGS FOR RUBBER HOSE
- VALVES**
- BRASS LOCK-ON FIELD ATTACHABLE COUPLINGS
- SINGLE BEAD
- BARB STEM
- INVERTED FLARE
- AUTOMOTIVE ADAPTERS
- COPPER TUBING INDUSTRIAL COMPRESSION
- INDUSTRIAL SURELOK
- MINI-BARBED TUBE
- POLY INDUSTRIAL COMPRESSION
- PIPE ADAPTERS
- ADAPTERS SAE FLARE
- THREADED SLEEVE
- KITS & ASSORTMENTS

Drain Cock - Male Pipe Internal Seat - Bibb Nose - Long

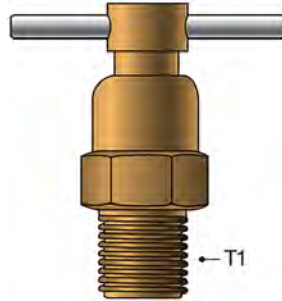

Part No.	Desc.		Standard Pack
		T1 (in)	
G33830-0002	2MP-ISDC	1/8-27	1
G33830-0004	4MP-ISDC	1/4-18	1
G33830-0006	6MP-ISDC	3/8-18	1

Drain Cock - Male Pipe to Tube External Seat - Long

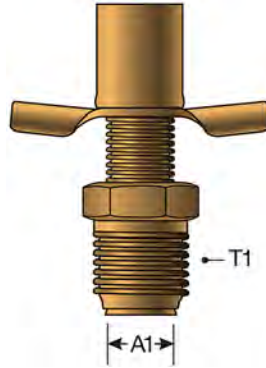

Part No.	Desc.	A1		Standard Pack
		"	T1 (in)	
G33831-0004	4MP-ESDC	1/4	1/4-18	1

- AIR BRAKE NYLON TUBING
- AIR BRAKE COPPER TUBING
- AIR BRAKE SURELOK
- COMPOSITE AIR BRAKE SURELOK
- AIR BRAKE COMPRESSION FITTINGS
- AIR BRAKE COUPLINGS FOR RUBBER HOSE
- VALVES**
- BRASS LOCK-ON FIELD ATTACHABLE COUPLINGS
- SINGLE BEAD
- BARB STEM
- INVERTED FLARE
- AUTOMOTIVE ADAPTERS
- COPPER TUBING INDUSTRIAL COMPRESSION
- INDUSTRIAL SURELOK
- MINI-BARBED TUBE
- POLY INDUSTRIAL COMPRESSION
- PIPE ADAPTERS
- ADAPTERS SAE FLARE
- THREADED SLEEVE
- KITS & ASSORTMENTS

Air Shut-Off Cock - Male Pipe - Bibb Nose with Key Handle

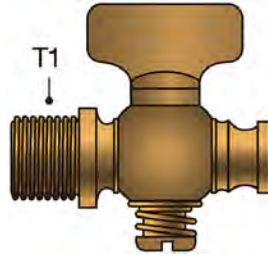

Part No.	Desc.			Standard Pack
		T1 (in)		
G33832-0202	2MP-ADCBN	1/8-27		1
G33832-0404	4MP-ADCBN	1/4-18		1
G33832-0808	8MP-ADCBN	1/2-14		1

Air Tank Valve

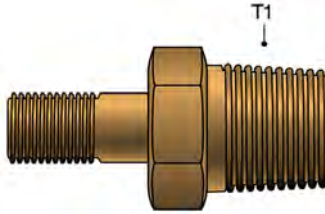

Part No.	Desc.			Standard Pack
		T1 (in)		
G33850-0202	2ATNKV	1/8-27		1
G33850-0404	4ATNKV	1/4-18		1

Needle Valve - Copper Tubing Ind. Compression to Copper Tubing Ind. Compression Run

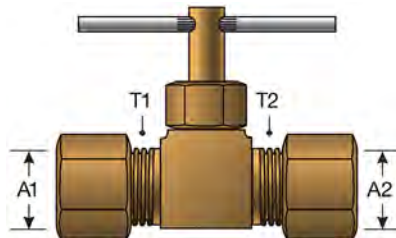

Part No.	Desc.	A1	A2			Standard Pack
		"	"	T1 (in)	T2 (in)	
G33901-0303	3MFA-3MFANV	3/16	3/16	3/8-24	3/8-24	1
G33901-0404	4MFA-4MFANV	1/4	1/4	7/16-24	7/16-24	1
G33901-0505	5MFA-5MFANV	5/16	5/16	1/2-24	1/2-24	1
G33901-0606	6MFA-6MFANV	3/8	3/8	9/16-24	9/16-24	1

AIR BRAKE
NYLON TUBING

AIR BRAKE
COPPER TUBING

AIR BRAKE
SURELOK

COMPOSITE AIR
BRAKE SURELOK

AIR BRAKE
COMPRESSION
FITTINGS

AIR BRAKE
COUPLINGS FOR
RUBBER HOSE

VALVES

BRASS LOCK-ON
FIELD
ATTACHABLE
COUPLINGS

SINGLE BEAD

BARB STEM

INVERTED FLARE

AUTOMOTIVE
ADAPTERS

COPPER TUBING
INDUSTRIAL
COMPRESSION

INDUSTRIAL
SURELOK

MINI-BARBED
TUBE

POLY
INDUSTRIAL
COMPRESSION

PIPE ADAPTERS

ADAPTERS SAE
FLARE

THREADED
SLEEVE

KITS &
ASSORTMENTS

Needle Valve 90° - Copper Tubing Industrial Compression to Male Pipe

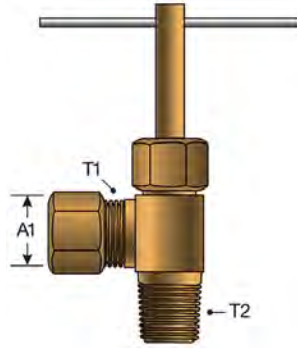

Part No.	Desc.	A1			Standard Pack
		"	T1 (in)	T2 (in)	
G33905-0302	3MFA-2MP90NV	3/16	3/8-24	1/8-27	1
G33905-0402	4MFA-2MP90NV	1/4	7/16-24	1/8-27	1
G33905-0404	4MFA-4MP90NV	1/4	7/16-24	1/4-18	1
G33905-0502	5MFA-2MP90NV	5/16	1/2-24	1/8-27	1
G33905-0504	5MFA-4MP90NV	5/16	1/2-24	1/4-18	1
G33905-0602	6MFA-2MP90NV	3/8	9/16-24	1/8-27	1
G33905-0604	6MFA-4MP90NV	3/8	9/16-24	1/4-18	1

Needle Valve - Copper Tubing Industrial Compression to Male Pipe

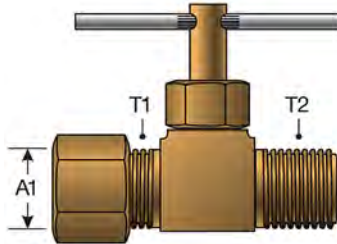

Part No.	Desc.	A1			Standard Pack
		"	T1 (in)	T2 (in)	
G33910-0202	2MFA-2MPNV	1/8	5/16-24	1/8-27	1
G33910-0302	3MFA-2MPNV	3/16	3/8-24	1/8-27	1
G33910-0402	4MFA-2MPNV	1/4	7/16-24	1/8-27	1
G33910-0404	4MFA-4MPNV	1/4	7/16-24	1/4-18	1
G33910-0502	5MFA-2MPNV	5/16	1/2-24	1/8-27	1
G33910-0504	5MFA-4MPNV	5/16	1/2-24	1/4-18	1
G33910-0604	6MFA-4MPNV	3/8	9/16-24	1/4-18	1

Needle Valve - Male Pipe to Male Pipe

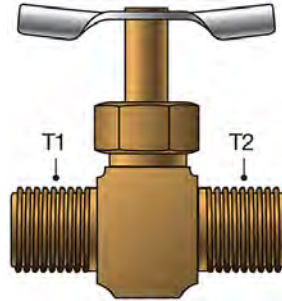

Part No.	Desc.			Standard Pack
		T1 (in)	T2 (in)	
G33915-0202	2MP-2MPNV	1/8-27	1/8-27	1
G33915-0404	4MP-4MPNV	1/4-18	1/4-18	1

Needle Valve - Male Pipe to Female Pipe

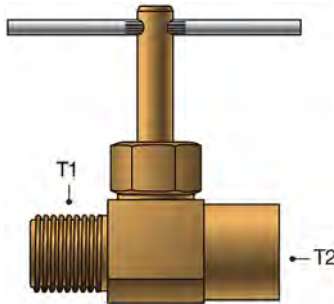

Part No.	Desc.			Standard Pack
		T1 (in)	T2 (in)	
G33920-0202	2MP-2FPNV	1/8-27	1/8-27	1
G33920-0404	4MP-4FPNV	1/4-18	1/4-18	1

Needle Valve - Female Pipe to Female Pipe

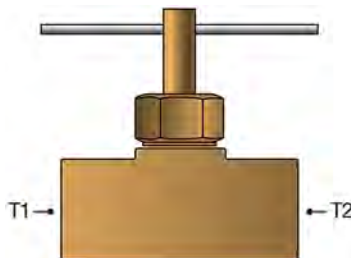

Part No.	Desc.			Standard Pack
		T1 (in)	T2 (in)	
G33930-0202	2FP-2FPNV	1/8-27	1/8-27	1
G33930-0404	4FP-4FPNV	1/4-18	1/4-18	1

- AIR BRAKE NYLON TUBING
- AIR BRAKE COPPER TUBING
- AIR BRAKE SURELOK
- COMPOSITE AIR BRAKE SURELOK
- AIR BRAKE COMPRESSION FITTINGS
- AIR BRAKE COUPLINGS FOR RUBBER HOSE

VALVES

- BRASS LOCK-ON FIELD ATTACHABLE COUPLINGS
- SINGLE BEAD
- BARB STEM
- INVERTED FLARE
- AUTOMOTIVE ADAPTERS
- COPPER TUBING INDUSTRIAL COMPRESSION
- INDUSTRIAL SURELOK
- MINI-BARBED TUBE
- POLY INDUSTRIAL COMPRESSION
- PIPE ADAPTERS
- ADAPTERS SAE FLARE
- THREADED SLEEVE
- KITS & ASSORTMENTS

Needle Valve - Male SAE 45° Flare to Male Pipe

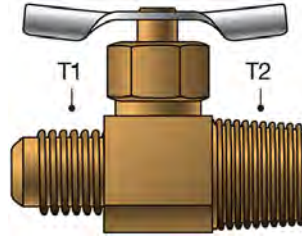

Part No.	Desc.			Standard Pack
		T1 (in)	T2 (in)	
G33940-0402	4MS-2MPNV	7/16-20	1/8-27	1
G33940-0404	4MS-4MPNV	7/16-20	1/4-18	1
G33940-0502	5MS-2MPNV	1/2-20	1/8-27	1
G33940-0504	5MS-4MPNV	1/2-20	1/4-18	1
G33940-0604	6MS-4MPNV	5/8-18	1/4-18	1

Needle Valve 90° - Male SAE 45° Flare to Male Pipe

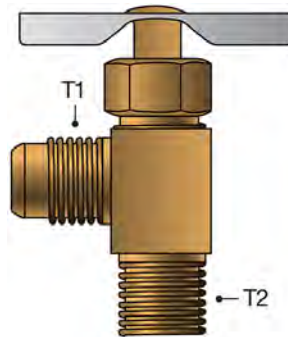

Part No.	Desc.			Standard Pack
		T1 (in)	T2 (in)	
G33945-0402	4MS-2MP90NV	7/16-20	1/8-27	1
G33945-0502	5MS-2MP90NV	1/2-20	1/8-27	1
G33945-0504	5MS-4MP90NV	1/2-20	1/4-18	1
G33945-0604	6MS-4MP90NV	5/8-18	1/4-18	1

Needle Valve - Male SAE 45° Flare to Male SAE 45° Flare

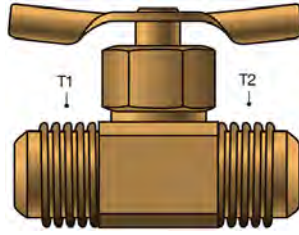

Part No.	Desc.			Standard Pack
		T1 (in)	T2 (in)	
G33950-0404	4MS-4MSNV	7/16-20	7/16-20	1
G33950-0606	6MS-6MSNV	5/8-18	5/8-18	1

Plastic Drain Cock - Chrysler Black Key Style



Part No.	Desc.			Standard Pack
		T1 (in)		
G49001-0000		Captive		1

Plastic Drain Cock - General Motors

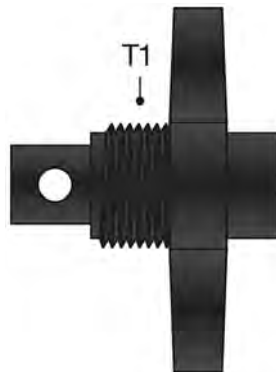

Part No.	Desc.			Standard Pack
		T1 (in)		
G49002-0000		Oversized		1

- AIR BRAKE NYLON TUBING
- AIR BRAKE COPPER TUBING
- AIR BRAKE SURELOK
- COMPOSITE AIR BRAKE SURELOK
- AIR BRAKE COMPRESSION FITTINGS
- AIR BRAKE COUPLINGS FOR RUBBER HOSE

VALVES

- BRASS LOCK-ON FIELD ATTACHABLE COUPLINGS
- SINGLE BEAD
- BARB STEM
- INVERTED FLARE
- AUTOMOTIVE ADAPTERS
- COPPER TUBING INDUSTRIAL COMPRESSION
- INDUSTRIAL SURELOK
- MINI-BARBED TUBE
- POLY INDUSTRIAL COMPRESSION
- PIPE ADAPTERS
- ADAPTERS SAE FLARE
- THREADED SLEEVE
- KITS & ASSORTMENTS

AIR BRAKE NYLON TUBING
AIR BRAKE COPPER TUBING
AIR BRAKE SURELOK
COMPOSITE AIR BRAKE SURELOK
AIR BRAKE COMPRESSION FITTINGS
AIR BRAKE COUPLINGS FOR RUBBER HOSE
VALVES
BRASS LOCK-ON FIELD ATTACHABLE COUPLINGS
SINGLE BEAD
BARB STEM
INVERTED FLARE
AUTOMOTIVE ADAPTERS
COPPER TUBING INDUSTRIAL COMPRESSION
INDUSTRIAL SURELOK
MINI-BARBED TUBE
POLY INDUSTRIAL COMPRESSION
PIPE ADAPTERS
ADAPTERS SAE FLARE
THREADED SLEEVE
KITS & ASSORTMENTS

Plastic Drain Cock - Ford (Short) 3



Part No.	Desc.		Standard Pack
		T1 (in)	
G49003-0000		Captive	1

Plastic Drain Cock - Ford (Long) 4



Part No.	Desc.		Standard Pack
		T1 (in)	
G49004-0000		Captive	1

Plastic Drain Cock - Metric Long Stem

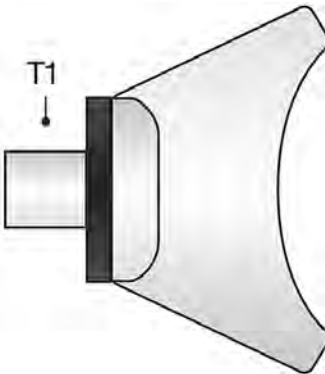

Part No.	Desc.		Standard Pack
		T1 (in)	
G49005-0000		M12X1.25	1
G49006-0000		M14X1.25	1
G49007-0000		M10X1.25	1

Plastic Drain Cock - Metric Short Stem

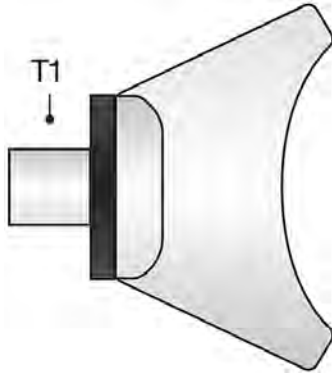

Part No.	Desc.			Standard Pack
		T1 (in)		
G49008-0000		M14X1.25		1

Plastic Drain Cock - Metric

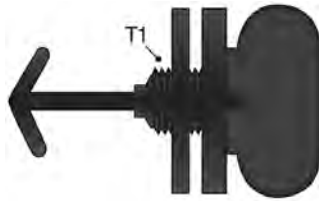

Part No.	Desc.			Standard Pack
		T1 (in)		
G49009-0000		M10X1.25		1

Plastic Drain Cock - Metric Single Bead

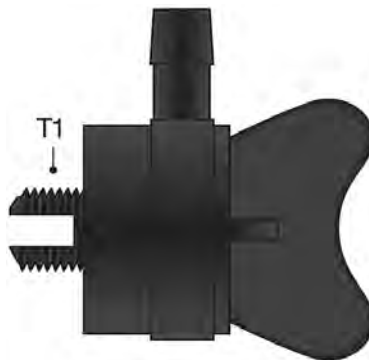

Part No.	Desc.			Standard Pack
		T1 (in)		
G49010-0000		M12X1.5		1

- AIR BRAKE NYLON TUBING
- AIR BRAKE COPPER TUBING
- AIR BRAKE SURELOK
- COMPOSITE AIR BRAKE SURELOK
- AIR BRAKE COMPRESSION FITTINGS
- AIR BRAKE COUPLINGS FOR RUBBER HOSE
- VALVES**
- BRASS LOCK-ON FIELD ATTACHABLE COUPLINGS
- SINGLE BEAD
- BARB STEM
- INVERTED FLARE
- AUTOMOTIVE ADAPTERS
- COPPER TUBING INDUSTRIAL COMPRESSION
- INDUSTRIAL SURELOK
- MINI-BARBED TUBE
- POLY INDUSTRIAL COMPRESSION
- PIPE ADAPTERS
- ADAPTERS SAE FLARE
- THREADED SLEEVE
- KITS & ASSORTMENTS

Plastic Drain Cock - Metric Ford and Mazda

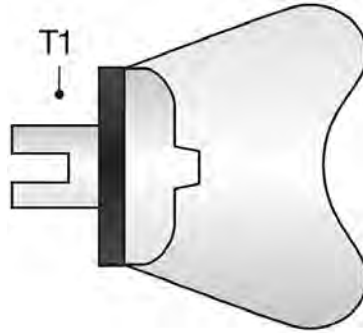

Part No.	Desc.		
		T1 (in)	Standard Pack
G49011-0000		M10X1.25	1
G49012-0000		M14X2.0	1

Plastic Drain Cock - Chrysler Long

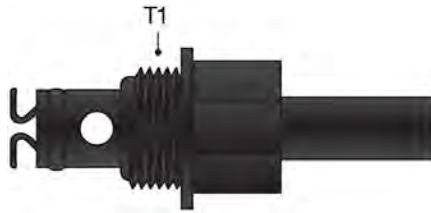

Part No.	Desc.		
		T1 (in)	Standard Pack
G49013-0000		5/8-18	1

Plastic Drain Cock - Metric Ford



Part No.	Desc.		
		T1 (in)	Standard Pack
G49014-0000		M14X2.0	1

Plastic Drain Cock - Chrysler Short

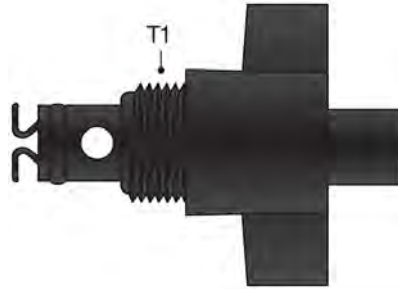

Part No.	Desc.		Standard Pack
		T1 (in)	
G49015-0000		5/8-18	1

Plastic Drain Cock - Chrysler Wide Opening

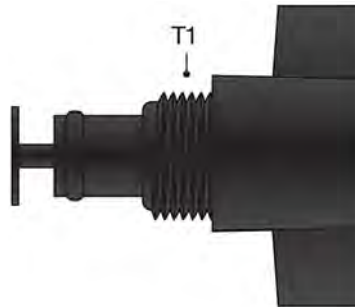

Part No.	Desc.		Standard Pack
		T1 (in)	
G49016-0000		5/8-18	1

Plastic Drain Cock - GM Black Key Style





Part No.	Desc.		Standard Pack
		T1 (in)	
G49017-0000		Captive	1

- AIR BRAKE NYLON TUBING
- AIR BRAKE COPPER TUBING
- AIR BRAKE SURELOK
- COMPOSITE AIR BRAKE SURELOK
- AIR BRAKE COMPRESSION FITTINGS
- AIR BRAKE COUPLINGS FOR RUBBER HOSE
- VALVES**
- BRASS LOCK-ON FIELD ATTACHABLE COUPLINGS
- SINGLE BEAD
- BARB STEM
- INVERTED FLARE
- AUTOMOTIVE ADAPTERS
- COPPER TUBING INDUSTRIAL COMPRESSION
- INDUSTRIAL SURELOK
- MINI-BARBED TUBE
- POLY INDUSTRIAL COMPRESSION
- PIPE ADAPTERS
- ADAPTERS SAE FLARE
- THREADED SLEEVE
- KITS & ASSORTMENTS

- AIR BRAKE NYLON TUBING
- AIR BRAKE COPPER TUBING
- AIR BRAKE SURELOK
- COMPOSITE AIR BRAKE SURELOK
- AIR BRAKE COMPRESSION FITTINGS
- AIR BRAKE COUPLINGS FOR RUBBER HOSE
- VALVES**
- BRASS LOCK-ON FIELD ATTACHABLE COUPLINGS
- SINGLE BEAD
- BARB STEM
- INVERTED FLARE
- AUTOMOTIVE ADAPTERS
- COPPER TUBING INDUSTRIAL COMPRESSION
- INDUSTRIAL SURELOK
- MINI-BARBED TUBE
- POLY INDUSTRIAL COMPRESSION
- PIPE ADAPTERS
- ADAPTERS SAE FLARE
- THREADED SLEEVE
- KITS & ASSORTMENTS

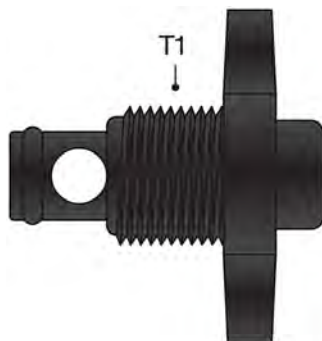
Plastic Drain Cock - GM



Part No.	Desc.		Standard Pack
		T1 (in)	
G49018-0000		1/2-18	1

Drain Cock - Male Pipe Internal Seat

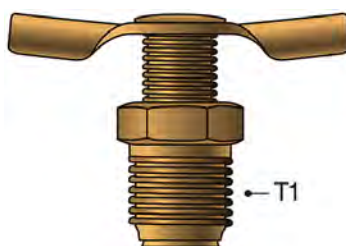

Part No.	Desc.		Standard Pack
		T1 (in)	
G49129-0004		1/4-18	1
G49130-0002		1/8-27	1
G49130-0004		1/4-18	1
G49130-0006		3/8-18	1

Drain Cock - Male Pipe to Tube Internal Seat - Long

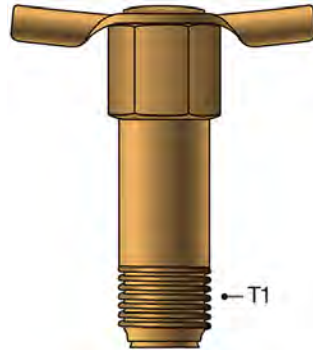

Part No.	Desc.		Standard Pack
		T1 (in)	
G49134-0002		1/8-27	1

Drain Cock - Male Pipe to Tube Internal Seat - Long Tube

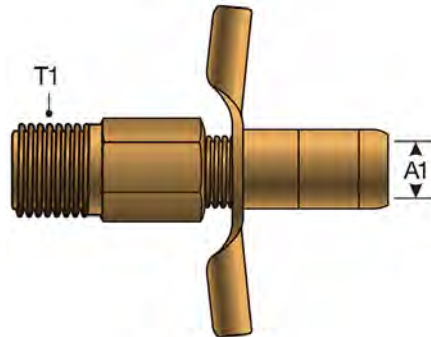

Part No.	Desc.	A1		Standard Pack
		"	T1 (in)	
G49135-0002		1/8	1/8-27	1

- AIR BRAKE NYLON TUBING
- AIR BRAKE COPPER TUBING
- AIR BRAKE SURELOK
- COMPOSITE AIR BRAKE SURELOK
- AIR BRAKE COMPRESSION FITTINGS
- AIR BRAKE COUPLINGS FOR RUBBER HOSE
- VALVES**
- BRASS LOCK-ON FIELD ATTACHABLE COUPLINGS
- SINGLE BEAD
- BARB STEM
- INVERTED FLARE
- AUTOMOTIVE ADAPTERS
- COPPER TUBING INDUSTRIAL COMPRESSION
- INDUSTRIAL SURELOK
- MINI-BARBED TUBE
- POLY INDUSTRIAL COMPRESSION
- PIPE ADAPTERS
- ADAPTERS SAE FLARE
- THREADED SLEEVE
- KITS & ASSORTMENTS

Drain Cock - Male Pipe Internal Seat - Bibb Nose

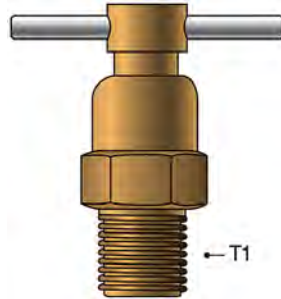

Part No.	Desc.		Standard Pack
		T1 (in)	
G49136-0002		1/8-27	1
G49136-0004		1/4-18	1
G49136-0006		3/8-18	1

Drain Cock 90° - Angle Bib Nose

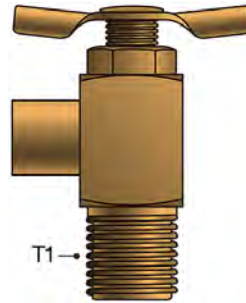

Part No.	Desc.		Standard Pack
		T1 (in)	
G49137-0002		1/8-27	1
G49137-0004		1/4-18	1

Drain Cock 90° - Single Bead to Male Pipe

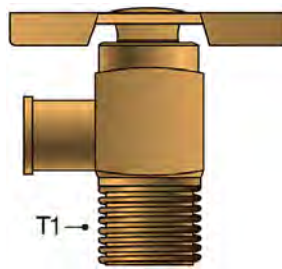

Part No.	Desc.		Standard Pack
		T1 (in)	
G49138-0604		1/4-18	1

Drain Cock - Male Pipe External Seat

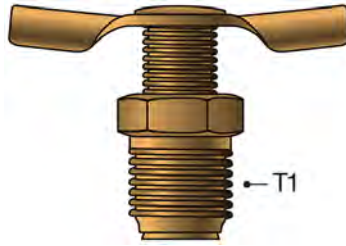

Part No.	Desc.		Standard Pack
		T1 (in)	
G49140-0002		1/8-27	1
G49140-0004		1/4-18	1
G49140-0006		3/8-18	1
G49140-0008		1/2-14	1

Gasoline Shut-Off with Screen Filter

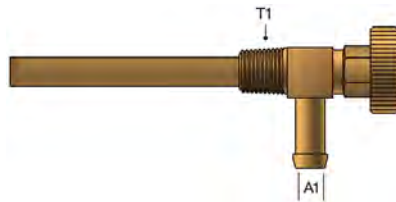

Part No.	Desc.	A1		Standard Pack
		"	T1 (in)	
G49255-0402		1/4	1/8-27	1

- AIR BRAKE NYLON TUBING
- AIR BRAKE COPPER TUBING
- AIR BRAKE SURELOK
- COMPOSITE AIR BRAKE SURELOK
- AIR BRAKE COMPRESSION FITTINGS
- AIR BRAKE COUPLINGS FOR RUBBER HOSE
- VALVES**
- BRASS LOCK-ON FIELD ATTACHABLE COUPLINGS
- SINGLE BEAD
- BARB STEM
- INVERTED FLARE
- AUTOMOTIVE ADAPTERS
- COPPER TUBING INDUSTRIAL COMPRESSION
- INDUSTRIAL SURELOK
- MINI-BARBED TUBE
- POLY INDUSTRIAL COMPRESSION
- PIPE ADAPTERS
- ADAPTERS SAE FLARE
- THREADED SLEEVE
- KITS & ASSORTMENTS

AIR BRAKE NYLON TUBING
AIR BRAKE COPPER TUBING
AIR BRAKE SURELOK
COMPOSITE AIR BRAKE SURELOK
AIR BRAKE COMPRESSION FITTINGS
AIR BRAKE COUPLINGS FOR RUBBER HOSE
VALVES
BRASS LOCK-ON FIELD ATTACHABLE COUPLINGS
SINGLE BEAD
BARB STEM
INVERTED FLARE
AUTOMOTIVE ADAPTERS
COPPER TUBING INDUSTRIAL COMPRESSION
INDUSTRIAL SURELOK
MINI-BARBED TUBE
POLY INDUSTRIAL COMPRESSION
PIPE ADAPTERS
ADAPTERS SAE FLARE
THREADED SLEEVE
KITS & ASSORTMENTS

Recommended For: Fuel lines, fluid lines or vacuum lines in low and medium pressure applications.

Used With: LOC and LOL Hose

Features and Benefits: Lock-On barbed stem fittings are quick connecting and resistant to damage from high vibration diesel applications. Hose clamps or ferrules are not needed or recommended.

Working Pressure: 300 psi (21 bar)

Temperature Range: -40°F to 250°F (-40°C to +121°C)

Material: 360 Brass

Assembly Instructions:

1. Measure and mark the hose length to be cut. When cutting, be sure to make the cut as even as possible. We recommended using a hand held hose cutter or a sharp knife.
2. Lubricate the hose and/or fittings with light oil or soapy water. Heavy oils or grease are not recommended as a lubricant.
3. Insert fitting until the first barb is in the hose.
4. Place the fitting end against a flat hard surface, such as a work bench, to finish inserting the fitting stem into the hose. You'll need to grip the hose approximately one inch from the end of the fitting and push until the end of the hose is fully over the stem and against the yellow plastic stop cap or the stop below the hex on the fitting. Note: a yellow stop cap is normally part of a Lock-On fitting.

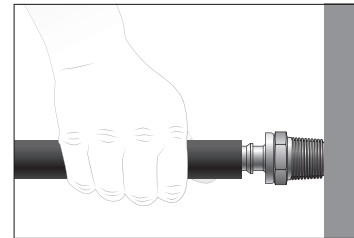

Precautions:

- Make sure the Lock-On fitting is fully inserted into the hose. Lock-On fittings will properly grip hose only when pushed all the way in, with the cut end of the hose completely concealed by the plastic cap.
- Using clamps with LOC Lock-On fittings is not recommended. Clamps will damage the seal causing leaks and an unsafe assembly.

Lock-On Fitting and Hose Disassembly Instructions:

1. Secure the fitting using a vise, sturdy workbench or other stable surface.
2. Starting at the yellow plastic stop cap, carefully cut the hose lengthwise approximately one inch away from the yellow stop cap.

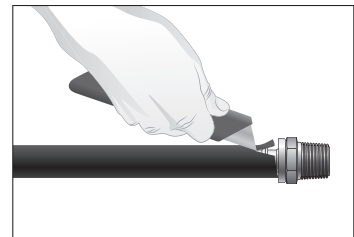

3. Cut slowly, making sure not to nick the fitting barbs.
4. Grip the hose firmly and give it a sharp downward tug away from the fitting to separate the fitting from the hose.

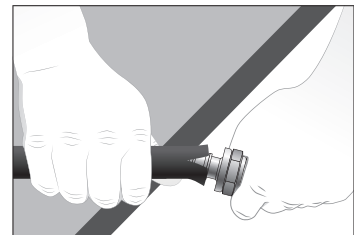

Male Pipe with Cone Seat

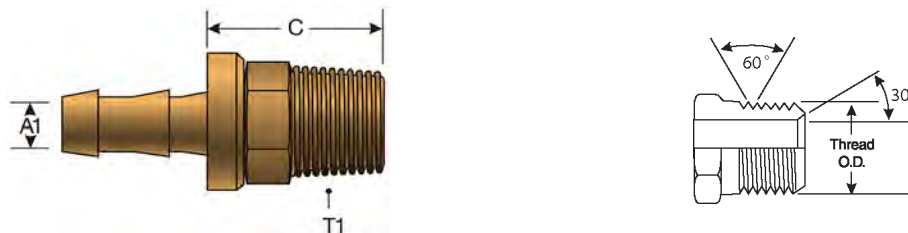

Part No.	Desc.	A1		T1 (in)	C		Standard Pack
		"	mm		"	mm	
G36100-0402	4LOC-2RMP	1/4	6.4	1/8-27	.56	14.2	1
G36100-0404	4LOC-4RMP	1/4	6.4	1/4-18	.81	20.6	1
G36100-0406	4LOC-6RMP	1/4	6.4	3/8-18	.88	22.4	1
G36100-0502	5LOC-2RMP	5/16	7.9	1/8-27	.81	20.6	1
G36100-0504	5LOC-4RMP	5/16	7.9	1/4-18	.77	19.6	1
G36100-0602	6LOC-2RMP	3/8	9.5	1/8-27	.56	14.2	1
G36100-0604	6LOC-4RMP	3/8	9.5	1/4-18	.81	20.6	1
G36100-0606	6LOC-6RMP	3/8	9.5	3/8-18	.88	22.4	1
G36100-0608	6LOC-8RMP	3/8	9.5	1/2-14	.88	22.4	1
G36100-0804	8LOC-4RMP	1/2	12.7	1/4-18	.81	20.6	1
G36100-0806	8LOC-6RMP	1/2	12.7	3/8-18	.88	22.4	1
G36100-0808	8LOC-8RMP	1/2	12.7	1/2-14	.88	22.4	1
G36100-0812	8LOC-12RMP	1/2	12.7	3/4-14	1.13	28.7	1
G36100-1006	10LOC-6RMP	5/8	15.9	3/8-18	.88	22.4	1
G36100-1008	10LOC-8RMP	5/8	15.9	1/2-14	1.06	26.9	1
G36100-1012	10LOC-12RMP	5/8	15.9	3/4-14	.88	22.4	1
G36100-1208	12LOC-8RMP	3/4	19.1	1/2-14	.88	22.4	1
G36100-1212	12LOC-12RMP	3/4	19.1	3/4-14	1.13	28.7	1

Male Pipe Swivel without Cone Seat

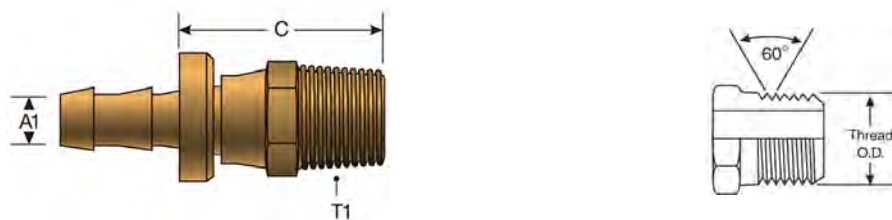

Part No.	Desc.	A1		T1 (in)	C		Standard Pack
		"	mm		"	mm	
G36105-0404	4LOC-4RMPX	1/4	6.4	1/4-18	1.81	46.0	1
G36105-0606	6LOC-6RMPX	3/8	9.5	3/8-18	2.00	50.8	1
G36105-0808	8LOC-8RMPX	1/2	12.7	1/2-14	2.38	60.5	1
G36105-1212	12LOC-12RMPX	3/4	19.1	3/4-14	2.68	68.1	1

AIR BRAKE NYLON TUBING

AIR BRAKE COPPER TUBING

AIR BRAKE SURELOK

COMPOSITE AIR BRAKE SURELOK

AIR BRAKE COMPRESSION FITTINGS

AIR BRAKE COUPLINGS FOR RUBBER HOSE

VALVES

BRASS LOCK-ON FIELD ATTACHABLE COUPLINGS

SINGLE BEAD

BARB STEM

INVERTED FLARE

AUTOMOTIVE ADAPTERS

COPPER TUBING INDUSTRIAL COMPRESSION

INDUSTRIAL SURELOK

MINI-BARBED TUBE

POLY INDUSTRIAL COMPRESSION

PIPE ADAPTERS

ADAPTERS SAE FLARE

THREADED SLEEVE

KITS & ASSORTMENTS

Male Pipe 90° Block with Cone Seat



Part No.	Desc.	A1		T1 (in)	C		Standard Pack
		"	mm		"	mm	
G36106-0402	4LOC-2RMP90	1/4	6.4	1/8-27	.31	7.9	1
G36106-0404	4LOC-4RMP90	1/4	6.4	1/4-18	.38	9.7	1
G36106-0502	5LOC-2RMP90	5/16	7.9	1/8-27	.31	7.9	1
G36106-0504	5LOC-4RMP90	5/16	7.9	1/4-18	.38	9.7	1
G36106-0602	6LOC-2RMP90	3/8	9.5	1/8-27	.38	9.7	1
G36106-0604	6LOC-4RMP90	3/8	9.5	1/4-18	.40	10.2	1
G36106-0606	6LOC-6RMP90	3/8	9.5	3/8-18	.43	10.9	1
G36106-0808	8LOC-8RMP90	1/2	12.7	1/2-14	.50	12.7	1
G36106-1212	12LOC-12RMP90	3/4	19.1	3/4-14	.76	19.3	1

Female Pipe without Cone Seat

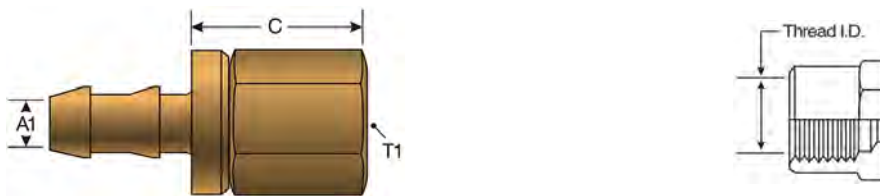

Part No.	Desc.	A1		T1 (in)	C		Standard Pack
		"	mm		"	mm	
G36110-0404	4LOC-4RFP	1/4	6.4	1/4-18	.50	12.7	1
G36110-0504	5LOC-4RFP	5/16	7.9	1/4-18	.50	12.7	1
G36110-0606	6LOC-6RFP	3/8	9.5	3/8-18	.63	16.0	1
G36110-0806	8LOC-6RFP	1/2	12.7	3/8-18	.63	16.0	1
G36110-0808	8LOC-8RFP	1/2	12.7	1/2-14	.75	19.1	1
G36110-1008	10LOC-8RFP	5/8	15.9	1/2-14	.75	19.1	1
G36110-1212	12LOC-12RFP	3/4	19.1	3/4-14	.93	23.6	1

Female Pipe Swivel with Cone Seat

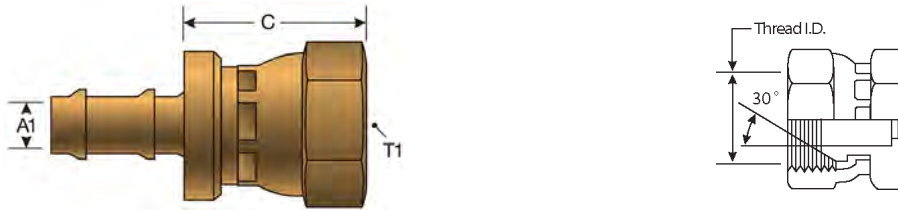

Part No.	Desc.	A1		T1 (in)	C		Standard Pack
		"	mm		"	mm	
G36111-0402	4LOC-2RFPX	1/4	6.4	1/8-27	1.81	46.0	1
G36111-0404	4LOC-4RFPX	1/4	6.4	1/4-18	1.81	46.0	1
G36111-0406	4LOC-6RFPX	1/4	6.4	3/8-18	2.00	50.8	1
G36111-0604	6LOC-4RFPX	3/8	9.5	1/4-18	1.81	46.0	1
G36111-0606	6LOC-6RFPX	3/8	9.5	3/8-18	2.00	50.8	1
G36111-0608	6LOC-8RFPX	3/8	9.5	1/2-14	2.38	60.5	1
G36111-0808	8LOC-8RFPX	1/2	12.7	1/2-14	2.38	60.5	1
G36111-0812	8LOC-12RFPX	1/2	12.7	3/4-14	2.68	68.1	1
G36111-1012	10LOC-12RFPX	5/8	15.9	3/4-14	2.68	68.1	1
G36111-1212	12LOC-12RFPX	3/4	19.1	3/4-14	2.68	68.1	1

Male JIC 37° Flare

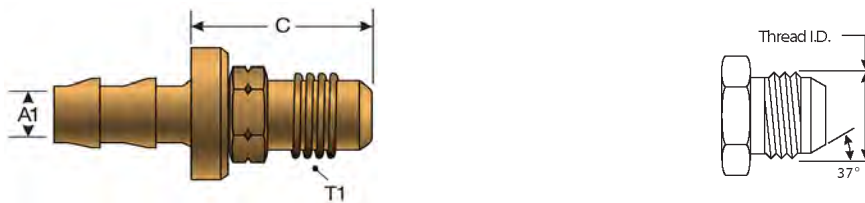

Part No.	Desc.	A1		T1 (in)	C		Standard Pack
		"	mm		"	mm	
G36165-0404	4LOC-4RMJ	1/4	6.4	7/16-20	.81	20.6	1
G36165-0405	4LOC-5RMJ	1/4	6.4	1/2-20	.94	23.9	1
G36165-0406	4LOC-6RMJ	1/4	6.4	9/16-18	1.00	25.4	1
G36165-0604	6LOC-4RMJ	3/8	9.5	7/16-20	.88	22.4	1
G36165-0605	6LOC-5RMJ	3/8	9.5	1/2-20	.94	23.9	1
G36165-0606	6LOC-6RMJ	3/8	9.5	9/16-18	1.00	25.4	1
G36165-0608	6LOC-8RMJ	3/8	9.5	3/4-16	1.19	30.2	1
G36165-0808	8LOC-8RMJ	1/2	12.7	3/4-16	1.19	30.2	1
G36165-0810	8LOC-10RMJ	1/2	12.7	7/8-14	1.27	32.3	1
G36165-1008	10LOC-8RMJ	5/8	15.9	3/4-16	1.19	30.2	1
G36165-1010	10LOC-10RMJ	5/8	15.9	7/8-14	1.27	32.3	1
G36165-1210	12LOC-10RMJ	3/4	19.1	7/8-14	1.27	32.3	1
G36165-1212	12LOC-12RMJ	3/4	19.1	1 1/16-12	1.33	33.8	1

- AIR BRAKE NYLON TUBING
- AIR BRAKE COPPER TUBING
- AIR BRAKE SURELOK
- COMPOSITE AIR BRAKE SURELOK
- AIR BRAKE COMPRESSION FITTINGS
- AIR BRAKE COUPLINGS FOR RUBBER HOSE
- VALVES
- BRASS LOCK-ON FIELD ATTACHABLE COUPLINGS
- SINGLE BEAD
- BARB STEM
- INVERTED FLARE
- AUTOMOTIVE ADAPTERS
- COPPER TUBING INDUSTRIAL COMPRESSION
- INDUSTRIAL SURELOK
- MINI-BARBED TUBE
- POLY INDUSTRIAL COMPRESSION
- PIPE ADAPTERS
- ADAPTERS SAE FLARE
- THREADED SLEEVE
- KITS & ASSORTMENTS

Female JIC 37° Flare Swivel

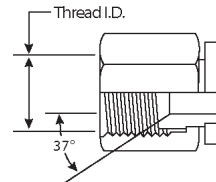
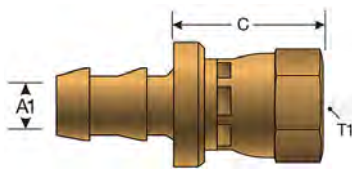

Part No.	Desc.	A1		T1 (in)	C		Standard Pack
		"	mm		"	mm	
G36170-0406	4LOC-6RFJX	1/4	6.4	9/16-18	.74	18.8	1
G36170-0606	6LOC-6RFJX	3/8	9.5	9/16-18	.81	20.6	1
G36170-1212	12LOC-12RFJX	3/4	19.1	1 1/16-12	1.09	27.7	1

Male SAE 45° Flare

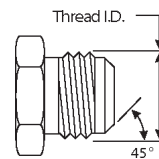
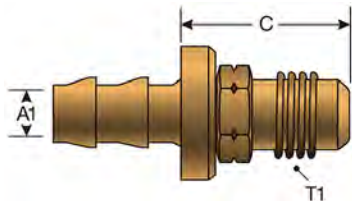

Part No.	Desc.	A1		T1 (in)	C		Standard Pack
		"	mm		"	mm	
G36195-0404	4LOC-4RMS	1/4	6.4	7/16-20	.69	17.5	1
G36195-0405	4LOC-5RMS	1/4	6.4	1/2-20	.38	9.7	1
G36195-0406	4LOC-6RMS	1/4	6.4	5/8-18	.88	22.4	1
G36195-0505	5LOC-5RMS	5/16	7.9	1/2-20	.81	20.6	1
G36195-0604	6LOC-4RMS	3/8	9.5	7/16-20	.69	17.5	1
G36195-0605	6LOC-5RMS	3/8	9.5	1/2-20	.81	20.6	1
G36195-0606	6LOC-6RMS	3/8	9.5	5/8-18	.88	22.4	1
G36195-0608	6LOC-8RMS	3/8	9.5	3/4-16	1.31	33.3	1
G36195-0808	8LOC-8RMS	1/2	12.7	3/4-16	1.13	28.7	1
G36195-0810	8LOC-10RMS	1/2	12.7	7/8-14	1.27	32.3	1
G36195-1008	10LOC-8RMS	5/8	15.9	3/4-16	1.13	28.7	1
G36195-1010	10LOC-10RMS	5/8	15.9	7/8-14	1.27	32.3	1
G36195-1210	12LOC-10RMS	3/4	19.1	7/8-14	1.27	32.3	1
G36195-1212	12LOC-12RMS	3/4	19.1	1 1/16-14	1.83	46.5	1

Female SAE 45° Flare Swivel



Part No.	Desc.	A1		T1 (in)	C		Standard Pack
		"	mm		"	mm	
G36200-0406	4LOC-6RFSX	1/4	6.4	5/8-18	.69	17.5	1
G36200-0506	5LOC-6RFSX*	5/16	7.9	5/8-18	.81	20.6	1
G36200-0606	6LOC-6RFSX	3/8	9.5	5/8-18	.84	21.3	1
G36200-0606X	6LOC-6RFSX XBULK	3/8	9.5	5/8-18	.84	21.3	100
G36200-0806	8LOC-6RFSX	1/2	12.7	5/8-18	.84	21.3	1
G36200-1212	12LOC-12RFSX	3/4	19.1	1 1/16-14	1.09	27.7	1

*Steel

Dual Seat Female JIC 37°/SAE 45° Flare Swivel

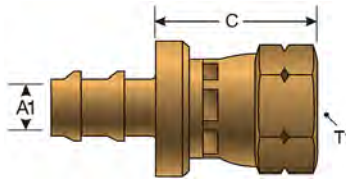

Part No.	Desc.	A1		T1 (in)	C		Standard Pack
		"	mm		"	mm	
G36210-0404	4LOC-4RFJSX	1/4	6.4	7/16-20	.75	19.1	1
G36210-0405	4LOC-5RFJSX	1/4	6.4	1/2-20	.78	19.8	1
G36210-0505	5LOC-5RFJSX*	5/16	7.9	1/2-20	.81	20.6	1
G36210-0605	6LOC-5RFJSX	3/8	9.5	1/2-20	.81	20.6	1
G36210-0608	6LOC-8RFJSX	3/8	9.5	3/4-16	.97	24.6	1
G36210-0808	8LOC-8RFJSX	1/2	12.7	3/4-16	.97	24.6	1
G36210-0810	8LOC-10RFJSX	1/2	12.7	7/8-14	1.00	25.4	1
G36210-1010	10LOC-10RFJSX	5/8	15.9	7/8-14	1.00	25.4	1
G36210-1210	12LOC-10RFJSX	3/4	19.1	7/8-14	1.00	25.4	1

*Steel

AIR BRAKE
NYLON TUBING

AIR BRAKE
COPPER TUBING

AIR BRAKE
SURELOK

COMPOSITE AIR
BRAKE SURELOK

AIR BRAKE
COMPRESSION
FITTINGS

AIR BRAKE
COUPLINGS FOR
RUBBER HOSE

VALVES

BRASS LOCK-ON
FIELD
ATTACHABLE
COUPLINGS

SINGLE BEAD

BARB STEM

INVERTED FLARE

AUTOMOTIVE
ADAPTERS

COPPER TUBING
INDUSTRIAL
COMPRESSION

INDUSTRIAL
SURELOK

MINI-BARBED
TUBE

POLY
INDUSTRIAL
COMPRESSION

PIPE ADAPTERS

ADAPTERS SAE
FLARE

THREADED
SLEEVE

KITS &
ASSORTMENTS

Male SAE Inverted Flare Swivel

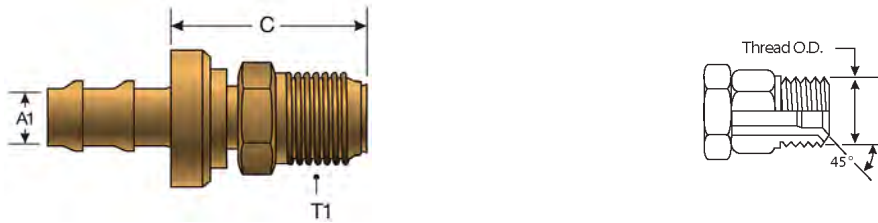

Part No.	Desc.	A1		T1 (in)	C		Standard Pack
		"	mm		"	mm	
G36500-0403	4LOC-3RMIX	1/4	6.4	3/8-24	.78	19.8	1
G36500-0404	4LOC-4RMIX	1/4	6.4	7/16-24	.78	19.8	1
G36500-0405	4LOC-5RMIX	1/4	6.4	1/2-20	.78	19.8	1
G36500-0504	5LOC-4RMIX	5/16	7.9	1/2-20	.78	19.8	1
G36500-0505	5LOC-5RMIX	5/16	7.9	1/2-20	.82	20.8	1
G36500-0506	5LOC-6RMIX	5/16	7.9	5/8-18	.86	21.8	1
G36500-0605	6LOC-5RMIX	3/8	9.5	1/2-20	.82	20.8	1
G36500-0606	6LOC-6RMIX	3/8	9.5	5/8-18	.97	24.6	1
G36500-0608	6LOC-8RMIX	3/8	9.5	3/4-18	1.00	25.4	1
G36500-0806	8LOC-6RMIX	1/2	12.7	5/8-18	.97	24.6	1
G36500-0808	8LOC-8RMIX	1/2	12.7	3/4-18	1.00	25.4	1
G36500-1010	10LOC-10RMIX	5/8	15.9	7/8-18	1.00	25.4	1

Female SAE Inverted Flare

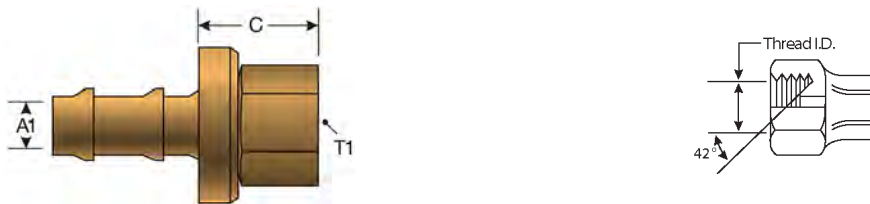

Part No.	Desc.	A1		T1 (in)	C		Standard Pack
		"	mm		"	mm	
G36508-0403	4LOC-3RFI	1/4	6.4	3/8-24	.75	19.1	1
G36508-0404	4LOC-4RFI	1/4	6.4	7/16-24	.75	19.1	1
G36508-0405	4LOC-5RFI	1/4	6.4	1/2-20	.75	19.1	1
G36508-0505	5LOC-5RFI	5/16	7.9	1/2-20	.75	19.1	1
G36508-0605	6LOC-5RFI	3/8	9.5	1/2-20	.75	19.1	1
G36508-0606	6LOC-6RFI	3/8	9.5	5/8-18	.88	22.4	1
G36508-0808	8LOC-8RFI	1/2	12.7	5/8-18	.93	23.6	1

North American Stand Pipe

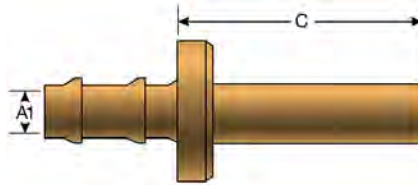

Part No.	Desc.	A1		C		Standard Pack
		"	mm	"	mm	
G36520-0403	4LOC-3RFT	1/4	6.4	.75	19.1	1
G36520-0404	4LOC-4RFT	1/4	6.4	1.00	25.4	1
G36520-0405	4LOC-5RFT	1/4	6.4	1.13	28.7	1
G36520-0505	5LOC-5RFT	5/16	7.9	1.13	28.7	1
G36520-0606	6LOC-6RSP	3/8	9.5	1.25	31.8	1
G36520-0808	8LOC-8RSP	1/2	12.7	1.00	25.4	1
G36520-1010	10LOC-10RSP	5/8	15.9	1.00	25.4	1

Hose Length Extenders



Part No.	Desc.	A1	A2	Standard Pack
		"	"	
G36535-0404	4LOC-4RHM	1/4	1/4	1
G36535-0505	5LOC-5RHM	5/16	5/16	1
G36535-0606	6LOC-6RHM	3/8	3/8	1
G36535-0808	8LOC-8RHM	1/2	1/2	1
G36535-0808X	8LOC-8RHMXBULK	1/2	1/2	30
G36535-1010	10LOC-10RHM	5/8	5/8	1
G36535-1212	12LOC-12RHM	3/4	3/4	1

Male British Standard Pipe Tapered

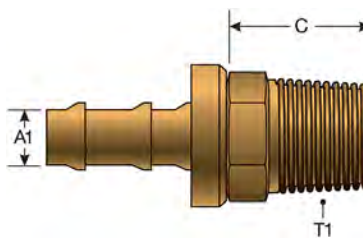

Part No.	Desc.	A1		T1 (in)	C		Standard Pack
		"	mm		"	mm	
G36795-0504	5LOC-4MBSPT	5/16	7.9	1/4-19	.63	16.0	1

- AIR BRAKE NYLON TUBING
- AIR BRAKE COPPER TUBING
- AIR BRAKE SURELOK
- COMPOSITE AIR BRAKE SURELOK
- AIR BRAKE COMPRESSION FITTINGS
- AIR BRAKE COUPLINGS FOR RUBBER HOSE
- VALVES
- BRASS LOCK-ON FIELD ATTACHABLE COUPLINGS
- SINGLE BEAD
- BARB STEM
- INVERTED FLARE
- AUTOMOTIVE ADAPTERS
- COPPER TUBING INDUSTRIAL COMPRESSION
- INDUSTRIAL SURELOK
- MINI-BARBED TUBE
- POLY INDUSTRIAL COMPRESSION
- PIPE ADAPTERS
- ADAPTERS SAE FLARE
- THREADED SLEEVE
- KITS & ASSORTMENTS

AIR BRAKE NYLON TUBING
AIR BRAKE COPPER TUBING
AIR BRAKE SURELOK
COMPOSITE AIR BRAKE SURELOK
AIR BRAKE COMPRESSION FITTINGS
AIR BRAKE COUPLINGS FOR RUBBER HOSE
VALVES
BRASS LOCK-ON FIELD ATTACHABLE COUPLINGS
SINGLE BEAD
BARB STEM
INVERTED FLARE
AUTOMOTIVE ADAPTERS
COPPER TUBING INDUSTRIAL COMPRESSION
INDUSTRIAL SURELOK
MINI-BARBED TUBE
POLY INDUSTRIAL COMPRESSION
PIPE ADAPTERS
ADAPTERS SAE FLARE
THREADED SLEEVE
KITS & ASSORTMENTS

Recommended For: Low pressure fuel, oil, compressed air and water lines used in small engines, vacuum advance and evaporative emission control systems.

Used With: Low pressure hose such as multi-purpose or general purpose hose.

Features and Benefits: Single bead fittings are quick connecting, field attachable and reusable. An economical choice for general purpose fluid applications. Single bead is sometimes referred to as beaded nipple.

Conformance: Contact Gates to verify compliance to desired specifications and suitability for particular applications.

Working Pressure: 60 psi (4 bar)

Temperature Range: -40°F to +250°F (-40°C to +121°C)

Material: 360 Brass

Assembly Instructions:

1. Cut hose as straight as possible.
2. Slide clamp on hose then lubricate hose or fitting.
3. Push hose on fitting until hose bottoms against hex or stop ring.
4. Position hose clamp between fitting bead on stem and end of hose and tighten.
5. Hose clamps required.

Male Pipe with Cone Seat

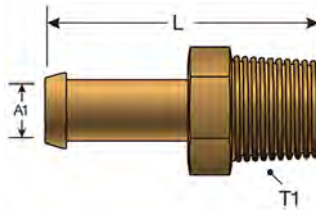

Part No.	Desc.	A1		T1 (in)	L		Standard Pack
		"	mm		"	mm	
G37100-0302	3SB-2RMP	3/16	4.8	1/8-27	1.26	32.0	1
G37100-0402	4SB-2RMP	1/4	6.4	1/8-27	1.32	33.5	1
G37100-0404	4SB-4RMP	1/4	6.4	1/4-18	1.63	41.4	1
G37100-0502	5SB-2RMP	5/16	7.9	1/8-27	1.55	39.4	1
G37100-0504	5SB-4RMP	5/16	7.9	1/4-18	1.55	39.4	1
G37100-0602	6SB-2RMP	3/8	9.7	1/8-27	1.55	39.4	1
G37100-0604	6SB-4RMP	3/8	9.7	1/4-18	1.63	41.4	1
G37100-0606	6SB-6RMP	3/8	9.7	3/8-18	1.72	43.7	1
G37100-0806	8SB-6RMP	1/2	12.7	3/8-18	1.72	43.7	1
G37100-0808	8SB-8RMP	1/2	12.7	1/2-14	1.79	45.5	1
G37100-1006	10SB-6RMP	5/8	15.9	3/8-18	1.78	45.2	1
G37100-1008	10SB-8RMP	5/8	15.9	1/2-14	1.78	45.2	1
G37100-1012	10SB-12RMP	5/8	15.9	3/4-14	1.92	48.8	1
G37100-1208	12SB-8RMP	3/4	19.1	1/2-14	1.78	45.2	1
G37100-1212	12SB-12RMP	3/4	19.1	3/4-14	1.92	48.8	1

Male Straight Thread Connector

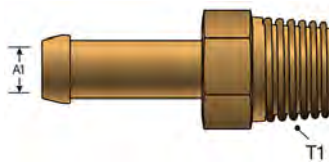

Part No.	Desc.	A1		T1 (in)	Standard Pack
		"	mm		
G37103-0609	6SB-9MSC	3/8	9.7	9/16-24	1
G37103-0610	6SB-10MSC	3/8	9.7	5/8-20	1
G37103-0614	6SB-14MSC	3/8	9.7	7/8-20	1

- AIR BRAKE NYLON TUBING
- AIR BRAKE COPPER TUBING
- AIR BRAKE SURELOK
- COMPOSITE AIR BRAKE SURELOK
- AIR BRAKE COMPRESSION FITTINGS
- AIR BRAKE COUPLINGS FOR RUBBER HOSE
- VALVES
- BRASS LOCK-ON FIELD ATTACHABLE COUPLINGS
- SINGLE BEAD**
- BARB STEM
- INVERTED FLARE
- AUTOMOTIVE ADAPTERS
- COPPER TUBING INDUSTRIAL COMPRESSION
- INDUSTRIAL SURELOK
- MINI-BARBED TUBE
- POLY INDUSTRIAL COMPRESSION
- PIPE ADAPTERS
- ADAPTERS SAE FLARE
- THREADED SLEEVE
- KITS & ASSORTMENTS

Male Pipe 90° Block Cone Seat

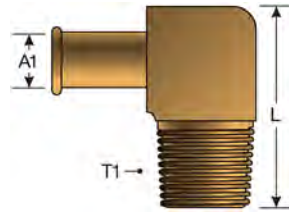

Part No.	Desc.	A1		T1 (in)	L		Standard Pack
		"	mm		"	mm	
G37106-0402	4SB-2RMP90	1/4	6.4	1/8-27	1.00	25.4	1
G37106-0502	5SB-2RMP90	5/16	7.9	1/8-27	1.01	25.7	1
G37106-0504	5SB-4RMP90	5/16	7.9	1/4-18	1.01	25.7	1
G37106-0602	6SB-2RMP90	3/8	9.7	1/8-27	1.01	25.7	1
G37106-0604	6SB-4RMP90	3/8	9.7	1/4-18	1.04	26.4	1
G37106-0606	6SB-6RMP90	3/8	9.7	3/8-14	1.08	27.4	1
G37106-0806	8SB-6RMP90	1/2	12.7	3/8-14	1.08	27.4	1
G37106-0808	8SB-8RMP90	1/2	12.7	1/2-14	1.16	29.5	1
G37106-1006	10SB-6RMP90	5/8	15.9	3/8-18	1.13	28.7	1
G37106-1008	10SB-8RMP90	5/8	15.9	1/2-14	1.21	30.7	1
G37106-1208	12SB-8RMP90	3/4	19.1	1/2-14	1.28	32.5	1

Male SAE 45° Flare Connector

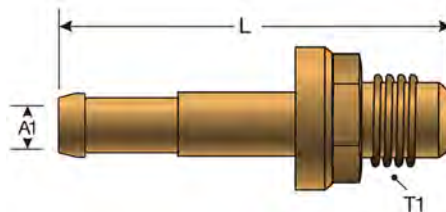

Part No.	Desc.	A1		T1 (in)	L		Standard Pack
		"	mm		"	mm	
G37195-0605	6SB-5RMS	3/8	9.7	1/2-20	2.00	50.8	1
G37195-0606	6SB-6RMS	3/8	9.7	3/8-18	2.00	50.8	1

Male SAE Inverted Flare Swivel

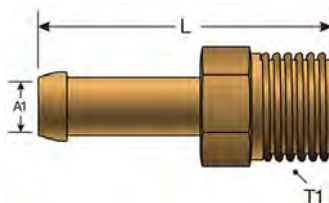

Part No.	Desc.	A1		T1 (in)	L		Standard Pack
		"	mm		"	mm	
G37500-0404	4SB-4RMIX	1/4	6.4	7/16-24	1.72	43.7	1

Male SAE Inverted Flare Swivel - Continued

Part No.	Desc.	A1		T1 (in)	L		Standard Pack
		"	mm		"	mm	
G37500-0405	4SB-5RMIX	1/4	6.4	1/2-20	1.78	45.2	1
G37500-0504	5SB-4RMIX	5/16	7.9	7/16-24	1.58	40.1	1
G37500-0505	5SB-5RMIX	5/16	7.9	1/2-20	1.58	40.1	1
G37500-0506	5SB-6RMIX	5/16	7.9	5/8-18	1.63	41.4	1
G37500-0605	6SB-5RMIX	3/8	9.7	1/2-20	1.73	44.0	1
G37500-0606	6SB-6RMIX	3/8	9.7	5/8-18	2.00	50.8	1

Male SAE Inverted Flare Swivel - 45°

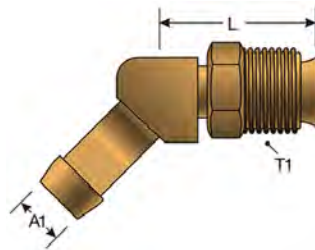

Part No.	Desc.	A1		T1 (in)	L		Standard Pack
		"	mm		"	mm	
G37503-0605	6SB-5RMIX45	3/8	9.7	1/2-20	1.25	31.8	1

Male SAE Inverted Flare Swivel - 90°

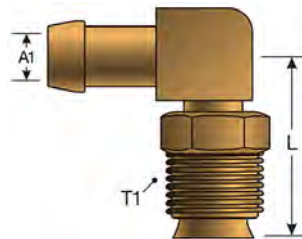

Part No.	Desc.	A1		T1 (in)	L		Standard Pack
		"	mm		"	mm	
G37504-0404	4SB-4RMIX90	1/4	6.4	7/16-24	1.01	25.7	1
G37504-0405	4SB-5RMIX90	1/4	6.4	1/2-20	1.01	25.7	1
G37504-0506	5SB-6RMIX90	5/16	7.9	5/8-18	1.21	30.7	1
G37504-0605	6SB-5RMIX90	3/8	9.7	1/2-20	1.21	30.7	1
G37504-0606	6SB-6RMIX90	3/8	9.7	5/8-18	1.40	35.6	1

- AIR BRAKE NYLON TUBING
- AIR BRAKE COPPER TUBING
- AIR BRAKE SURELOK
- COMPOSITE AIR BRAKE SURELOK
- AIR BRAKE COMPRESSION FITTINGS
- AIR BRAKE COUPLINGS FOR RUBBER HOSE
- VALVES
- BRASS LOCK-ON FIELD ATTACHABLE COUPLINGS
- SINGLE BEAD**
- BARB STEM
- INVERTED FLARE
- AUTOMOTIVE ADAPTERS
- COPPER TUBING INDUSTRIAL COMPRESSION
- INDUSTRIAL SURELOK
- MINI-BARBED TUBE
- POLY INDUSTRIAL COMPRESSION
- PIPE ADAPTERS
- ADAPTERS SAE FLARE
- THREADED SLEEVE
- KITS & ASSORTMENTS

Female SAE Inverted Flare

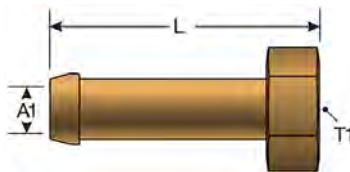

Part No.	Desc.	A1		T1 (in)	L		Standard Pack
		"	mm		"	mm	
G37508-0505	5SB-5RFI	5/16	7.9	1/2-20	2.03	51.6	1
G37508-0605	6SB-5RFI	3/8	9.7	1/2-20	2.09	53.1	1
G37508-0606	6SB-6RFI	3/8	9.7	5/8-18	2.16	54.9	1

- AIR BRAKE NYLON TUBING
- AIR BRAKE COPPER TUBING
- AIR BRAKE SURELOK
- COMPOSITE AIR BRAKE SURELOK
- AIR BRAKE COMPRESSION FITTINGS
- AIR BRAKE COUPLINGS FOR RUBBER HOSE
- VALVES
- BRASS LOCK-ON FIELD ATTACHABLE COUPLINGS
- SINGLE BEAD**
- BARB STEM
- INVERTED FLARE
- AUTOMOTIVE ADAPTERS
- COPPER TUBING INDUSTRIAL COMPRESSION
- INDUSTRIAL SURELOK
- MINI-BARBED TUBE
- POLY INDUSTRIAL COMPRESSION
- PIPE ADAPTERS
- ADAPTERS SAE FLARE
- THREADED SLEEVE
- KITS & ASSORTMENTS

Recommended For: Low pressure fuel, oil, compressed air, water and cooling lines. Typically used in heavy-duty truck, construction, industrial and mobile applications.

Used With: Low pressure multi-purpose or general purpose rubber hose and thermoplastic tubing.

Features and Benefits: Field attachable and reusable. An economical choice for general purpose fluid and pneumatic applications. The one-piece fitting is compact and great for use in tight spaces.

Conformance: Contact Gates to verify compliance to desired specifications and suitability for particular applications.

Working Pressure: 150 psi (10 bar)

Temperature Range: -40°F to +160°F (-40°C to +71°C)

Material: 360 Brass

Assembly Instructions:

1. Cut hose as straight as is possible.
2. Slide clamp on hose, then lubricate hose.
3. Push hose on fitting until hose bottoms against hex or stop ring.
4. Position hose clamp between fitting end and end of hose. Tighten the clamp.
5. Hose clamps are recommended when using a barbed stem.

AIR BRAKE NYLON TUBING
AIR BRAKE COPPER TUBING
AIR BRAKE SURELOK
COMPOSITE AIR BRAKE SURELOK
AIR BRAKE COMPRESSION FITTINGS
AIR BRAKE COUPLINGS FOR RUBBER HOSE
VALVES
BRASS LOCK-ON FIELD ATTACHABLE COUPLINGS
SINGLE BEAD
BARB STEM
INVERTED FLARE
AUTOMOTIVE ADAPTERS
COPPER TUBING INDUSTRIAL COMPRESSION
INDUSTRIAL SURELOK
MINI-BARBED TUBE
POLY INDUSTRIAL COMPRESSION
PIPE ADAPTERS
ADAPTERS SAE FLARE
THREADED SLEEVE
KITS & ASSORTMENTS

Male Pipe NPTF with Cone Seat

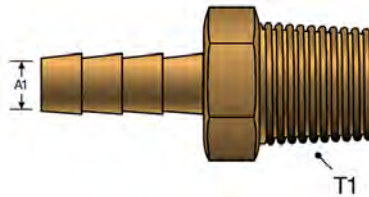

Part No.	Desc.	A1		Standard Pack
		"	T1 (in)	
G38100-0202	2BS-2MP	1/8	1/8-27	1
G38100-0302	3BS-2MP	3/16	1/8-27	1
G38100-0304	3BS-4MP	3/16	1/4-18	1
G38100-0402	4BS-2MP	1/4	1/8-27	1
G38100-0404	4BS-4MP	1/4	1/4-18	1
G38100-0406	4BS-6MP	1/4	3/8-18	1
G38100-0502	5BS-2MP	5/16	1/8-27	1
G38100-0504	5BS-4MP	5/16	1/4-18	1
G38100-0602	6BS-2MP	3/8	1/8-27	1
G38100-0604	6BS-4MP	3/8	1/4-18	1
G38100-0606	6BS-6MP	3/8	3/8-18	1
G38100-0608	6BS-8MP	3/8	1/2-14	1
G38100-0804	8BS-4MP	1/2	1/4-18	1
G38100-0806	8BS-6MP	1/2	3/8-18	1
G38100-0808	8BS-8MP	1/2	1/2-14	1
G38100-0812	8BS-12MP	1/2	3/4-14	1
G38100-1006	10BS-6MP	5/8	3/8-18	1
G38100-1008	10BS-8MP	5/8	1/2-14	1
G38100-1012	10BS-12MP	5/8	3/4-14	1
G38100-1208	12BS-8MP	3/4	1/2-14	1
G38100-1212	12BS-12MP	3/4	3/4-14	1

Female Pipe NPTF



Part No.	Desc.	A1		Standard Pack
		"	T1 (in)	
G38110-0202	2BS-2FP	1/8	1/8-27	1
G38110-0302	3BS-2FP	3/16	1/8-27	1
G38110-0402	4BS-2FP	1/4	1/8-27	1
G38110-0404	4BS-4FP	1/4	1/4-18	1
G38110-0502	5BS-2FP	5/16	1/8-27	1
G38110-0504	5BS-4FP	5/16	1/4-18	1
G38110-0602	6BS-2FP	3/8	1/8-27	1
G38110-0604	6BS-4FP	3/8	1/4-18	1
G38110-0606	6BS-6FP	3/8	3/8-18	1
G38110-0804	8BS-4FP	1/2	1/4-18	1
G38110-0806	8BS-6FP	1/2	3/8-18	1
G38110-0808	8BS-8FP	1/2	1/2-14	1

Recommended For: Hydraulic brake, fuel and oil lines, refrigerant in engine, air conditioning, marine and mobile applications. Products for use in LP and natural gas applications require special order.

Used With: Aluminum, brass, copper and steel tubing that can be flared.

Features and Benefits: An economical and reusable solution that can be field installed. Threads and seats can be assembled and disassembled for long service life. Tighter tube bends can be achieved using a short nut (brass or steel), whereas a long nut is recommended in applications where excessive, high vibration exists.

Conformance: Meets functional requirements of SAE J512 and specifications/standards of ASA, ASME, SAE and MS (Military Standards). Underwriters Laboratories listed (available special order only) for fuel equipment and gas.

Working Pressure: Dependent upon the tubing size (See below chart).

Tube O.D. (in)	1/8	3/16	1/4	5/16	3/8	7/16	1/2	5/8	3/4	7/8	1
Thread Size	5/16-28	3/8-24	7/16-24	1/2-20	5/8-18	11/16-18	3/4-18	7/8-18	1-1/16-16	1-3/16-16	1-5/16-16
PSI*	2800	1900	1400	1200	1000	875	750	650	550	450	350

*Lists typical PSI values at 73°F (23°C)

Burst Pressure: 5,000 psi with Bundy weld tubing (double-flared) and 3,500 psi with copper tubing, depending on size.

Temperature Range: -65°F to +250°F (-53°C to +121°C)

Material: 360 Brass

Assembly Instructions:

1. Measure and cut the tubing as straight as is possible to desired length.
2. Slide nut over the tubing, with threaded end of nut must face out, toward the tubing end to be flared.
3. Flare end of tube with a 45° flaring tool.
 - a) Measure the flare diameter and inspect for excessive thin out of the flare.
 - b) On thin wall, welded or brazed tubing, use double flare to prevent pinch-off and cracked flares.
4. Lubricate threads and assemble to connector body. Nut should be turned hand tight.
5. Tighten assembly with a wrench until a solid feeling and resistance is felt. Apply a one-sixth turn.

Caution: Do not over torque or you may damage the connectors or split the tubing at the flare.

- AIR BRAKE NYLON TUBING
- AIR BRAKE COPPER TUBING
- AIR BRAKE SURELOK
- COMPOSITE AIR BRAKE SURELOK
- AIR BRAKE COMPRESSION FITTINGS
- AIR BRAKE COUPLINGS FOR RUBBER HOSE
- VALVES
- BRASS LOCK-ON FIELD ATTACHABLE COUPLINGS
- SINGLE BEAD
- BARB STEM
- INVERTED FLARE**
- AUTOMOTIVE ADAPTERS
- COPPER TUBING INDUSTRIAL COMPRESSION
- INDUSTRIAL SURELOK
- MINI-BARBED TUBE
- POLY INDUSTRIAL COMPRESSION
- PIPE ADAPTERS
- ADAPTERS SAE FLARE
- THREADED SLEEVE
- KITS & ASSORTMENTS

Male Pipe to Female Pipe to Female Inverted Split Run Tee

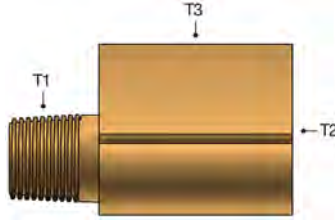

Part No.	Desc.				Standard Pack
		T1 (in)	T2 (in)	T3 (in)	
G49375-0204		1/8-27	1/8-27	3/8-24	1

Male Inverted Tube Nut - Steel

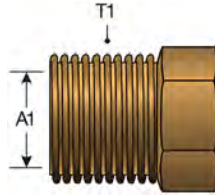

Part No.	Desc.	A1		Standard Pack
		"	T1 (in)	
G60596-0202	2T-2MIXN-S	1/8	5/16-28	1
G60596-0303	3T-3MIXN-S	3/16	3/8-24	1
G60596-0404	4T-4MIXN-S	1/4	7/16-24	1
G60596-0505	5T-5MIXN-S	5/16	1/2-20	1
G60596-0606	6T-6MIXN-S	3/8	5/8-18	1
G60596-0607	6T-7MIXN-S	3/8	11/16-18	1
G60596-0707	7T-7MIXN-S	7/16	11/16-18	1
G60596-0808	8T-8MIXN-S	1/2	3/4-18	1
G60596-1010	10T-10MIXN-S	5/8	7/8-18	1
G60596-1212	12T-12MIXN-S	3/4	1 1/16-16	1
G60596-1414	14T-14MIXN-S	7/8	1 3/16-16	1
G60596-1616	16T-16MIXN-S	1	1 5/16-16	1

Male Inverted Tube Nut - Steel - Long

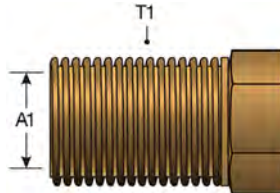

Part No.	Desc.	A1		Standard Pack
		"	T1 (in)	
G60597-0303	3T-3MIXN-SL	3/16	3/8-24	1
G60597-0404	4T-4MIXN-SL	1/4	7/16-24	1

Male Inverted Tube Nut - Brass

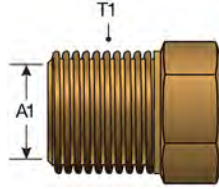

Part No.	Desc.	A1		Standard Pack
		"	T1 (in)	
G60599-0303	3T-3MIXN-B	3/16	3/8-24	1
G60599-0404	4T-4MIXN-B	1/4	7/16-24	1
G60599-0505	5T-5MIXN-B	5/16	1/2-20	1
G60599-0606	6T-6MIXN-B	3/8	5/8-18	1
G60599-0808	8T-8MIXN-B	1/2	3/4-18	1

Female Inverted Flare to Male Pipe

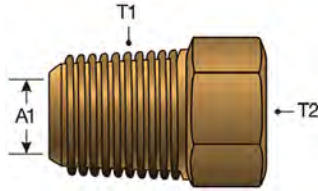

Part No.	Desc.	A1			Standard Pack
		"	T1 (in)	T2 (in)	
G60625-0202	2MP-2FI	1/8	1/8-27	5/16-28	1
G60625-0203	2MP-3FI	3/16	1/8-27	3/8-24	1
G60625-0204	2MP-4FI	1/4	1/8-27	7/16-24	1
G60625-0205	2MP-5FI	5/16	1/8-27	1/2-20	1
G60625-0206	2MP-6FI	3/8	1/8-27	5/8-18	1
G60625-0404	4MP-4FI	1/4	1/4-18	7/16-24	1
G60625-0405	4MP-5FI	5/16	1/4-18	1/2-20	1
G60625-0406	4MP-6FI	3/8	1/4-18	5/8-18	1
G60625-0408	4MP-8FI	1/2	1/4-18	3/4-18	1
G60625-0606	6MP-6FI	3/8	3/8-18	5/8-18	1
G60625-0607	6MP-7FI	7/16	3/8-18	11/16-18	1
G60625-0608	6MP-8FI	1/2	3/8-18	3/4-18	1
G60625-0808	8MP-8FI	1/2	1/2-14	3/4-18	1
G60625-0810	8MP-10FI	5/8	1/2-14	7/8-18	1
G60625-0812	8MP-12FI	3/4	1/2-14	1 1/16-16	1
G60625-1212	12MP-12FI	3/4	3/4-14	1 1/16-16	1
G60625-1214	12MP-14FI	7/8	3/4-14	1 3/16-16	1
G60625-1616	16MP-16FI	1	1-11 1/2	1 5/16-16	1

- AIR BRAKE NYLON TUBING
- AIR BRAKE COPPER TUBING
- AIR BRAKE SURELOK
- COMPOSITE AIR BRAKE SURELOK
- AIR BRAKE COMPRESSION FITTINGS
- AIR BRAKE COUPLINGS FOR RUBBER HOSE
- VALVES
- BRASS LOCK-ON FIELD ATTACHABLE COUPLINGS
- SINGLE BEAD
- BARB STEM
- INVERTED FLARE**
- AUTOMOTIVE ADAPTERS
- COPPER TUBING INDUSTRIAL COMPRESSION
- INDUSTRIAL SURELOK
- MINI-BARBED TUBE
- POLY INDUSTRIAL COMPRESSION
- PIPE ADAPTERS
- ADAPTERS SAE FLARE
- THREADED SLEEVE
- KITS & ASSORTMENTS

Female Inverted Flare to Male Pipe - 45°

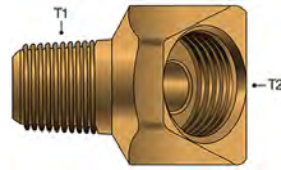

Part No.	Desc.			Standard Pack
		T1 (in)	T2 (in)	
G60626-0202	2MP-2FI45	1/8-27	5/16-28	1
G60626-0203	2MP-3FI45	1/8-27	3/8-24	1
G60626-0204	2MP-4FI45	1/8-27	7/16-24	1
G60626-0205	2MP-5FI45	1/8-27	1/2-20	1
G60626-0206	2MP-6FI45	1/8-27	5/8-18	1
G60626-0405	4MP-5FI45	1/4-18	1/2-20	1
G60626-0406	4MP-6FI45	1/4-18	5/8-18	1
G60626-0608	6MP-8FI45	3/8-18	3/4-18	1
G60626-0810	8MP-10FI45	1/2-14	7/8-18	1

Female Inverted Flare to Male Pipe - 90°

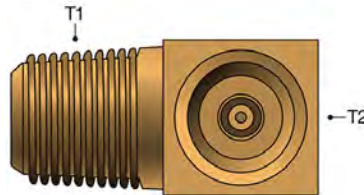

Part No.	Desc.			Standard Pack
		T1 (in)	T2 (in)	
G60627-0202	2MP-2FI90	1/8-27	5/16-28	1
G60627-0203	2MP-3FI90	1/8-27	3/8-24	1
G60627-0204	2MP-4FI90	1/8-27	7/16-24	1
G60627-0205	2MP-5FI90	1/8-27	1/2-20	1
G60627-0206	2MP-6FI90	1/8-27	5/8-18	1
G60627-0404	4MP-4FI90	1/4-18	7/16-24	1
G60627-0405	4MP-5FI90	1/4-18	1/2-20	1
G60627-0406	4MP-6FI90	1/4-18	5/8-18	1
G60627-0408	4MP-8FI90	1/4-18	3/4-18	1
G60627-0605	6MP-5FI90	3/8-18	1/2-20	1
G60627-0606	6MP-6FI90	3/8-18	5/8-18	1
G60627-0608	6MP-8FI90	3/8-18	3/4-18	1
G60627-0610	6MP-10FI90	3/8-18	7/8-18	1
G60627-0808	8MP-8FI90	1/2-14	3/4-18	1
G60627-0810	8MP-10FI90	1/2-14	7/8-18	1
G60627-0812	8MP-12FI90	1/2-14	1 1/16-16	1
G60627-1212	12MP-12FI90	3/4-14	1 1/16-16	1
G60627-1214	12MP-14FI90	3/4-14	1 3/16-16	1
G60627-1616	16MP-16FI90	1-11 1/2	1 5/16-16	1

Female Inverted Branch Tee to Male Pipe

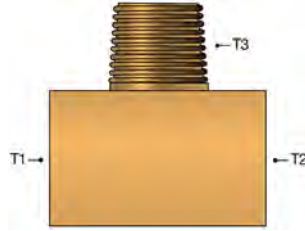

Part No.	Desc.	T			Standard Pack
		T1 (in)	T2 (in)	T3 (in)	
G60628-0302	3FI-3FI-2MP	3/8-24	3/8-24	1/8-27	1
G60628-0402	4FI-4FI-2MP	7/16-24	7/16-24	1/8-27	1
G60628-0504	5FI-5FI-4MP	1/2-20	1/2-20	1/4-18	1
G60628-0604	6FI-6FI-4MP	5/8-18	5/8-18	1/4-18	1

Female Inverted Run Tee to Male Pipe

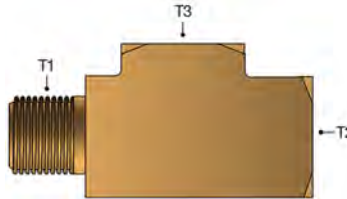

Part No.	Desc.	T			Standard Pack
		T1 (in)	T2 (in)	T3 (in)	
G60629-0203	2MP-3FI-3FI	1/8-27	3/8-24	3/8-24	1
G60629-0204	2MP-4FI-4FI	1/8-27	7/16-24	7/16-24	1
G60629-0205	2MP-5FI-5FI	1/8-27	1/2-20	1/2-20	1
G60629-0406	4MP-6FI-6FI	1/4-18	5/8-18	5/8-18	1
G60629-0408	4MP-8FI-8FI	1/4-18	3/4-18	3/4-18	1

Female Inverted to Female Pipe



Part No.	Desc.	T		Standard Pack
		T1 (in)	T2 (in)	
G60630-0202	2FP-2FI	1/8-27	5/16-28	1
G60630-0203	2FP-3FI	1/8-27	3/8-24	1
G60630-0204	2FP-4FI	1/8-27	7/16-24	1
G60630-0205	2FP-5FI	1/8-27	1/2-20	1
G60630-0404	4FP-4FI	1/4-18	7/16-24	1

AIR BRAKE
NYLON TUBING

AIR BRAKE
COPPER TUBING

AIR BRAKE
SURELOK

COMPOSITE AIR
BRAKE SURELOK

AIR BRAKE
COMPRESSION
FITTINGS

AIR BRAKE
COUPLINGS FOR
RUBBER HOSE

VALVES

BRASS LOCK-ON
FIELD
ATTACHABLE
COUPLINGS

SINGLE BEAD

BARB STEM

INVERTED FLARE

AUTOMOTIVE
ADAPTERS

COPPER TUBING
INDUSTRIAL
COMPRESSION

INDUSTRIAL
SURELOK

MINI-BARBED
TUBE

POLY
INDUSTRIAL
COMPRESSION

PIPE ADAPTERS

ADAPTERS SAE
FLARE

THREADED
SLEEVE

KITS &
ASSORTMENTS

Female Inverted to Female Pipe - Continued

Part No.	Desc.			Standard Pack
		T1 (in)	T2 (in)	
G60630-0406	4FP-6FI	1/4-18	5/8-18	1
G60630-0407	4FP-7FI	1/4-18	11/16-18	1
G60630-0608	6FP-8FI	3/8-18	3/4-18	1
G60630-0810	8FP-10FI	1/2-14	7/8-18	1
G60630-0812	8FP-12FI	1/2-14	1 1/16-16	1

Male Inverted Flare Plug

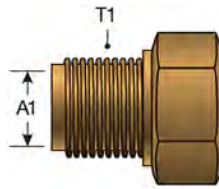

Part No.	Desc.	A1		Standard Pack
		"	T1 (in)	
G60691-0003	3MI-PLUG	3/16	3/8-24	1
G60691-0004	4MI-PLUG	1/4	7/16-24	1
G60691-0005	5MI-PLUG	5/16	1/2-20	1
G60691-0006	6MI-PLUG	3/8	5/8-18	1

Female Inverted to Female Inverted Union



Part No.	Desc.			Standard Pack
		T1 (in)	T2 (in)	
G60693-0202	2FI-2FI	5/16-28	5/16-28	1
G60693-0303	3FI-3FI	3/8-24	3/8-24	1
G60693-0404	4FI-4FI	7/16-24	7/16-24	1
G60693-0505	5FI-5FI	1/2-20	1/2-20	1
G60693-0606	6FI-6FI	5/8-18	5/8-18	1
G60693-0808	8FI-8FI	3/4-18	3/4-18	1
G60693-1010	10FI-10FI	7/8-18	7/8-18	1

Female Inverted to Female Inverted Union - 90°

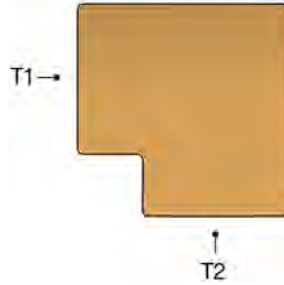

Part No.	Desc.	Standard Pack		Standard Pack
		T1 (in)	T2 (in)	
G60694-0404	4FI-4FI90	7/16-24	7/16-24	1
G60694-0505	5FI-5FI90	1/2-20	1/2-20	1
G60694-0606	6FI-6FI90	5/8-18	5/8-18	1
G60694-0808	8FI-8FI90	3/4-18	3/4-18	1

Female Inverted Union - Tee

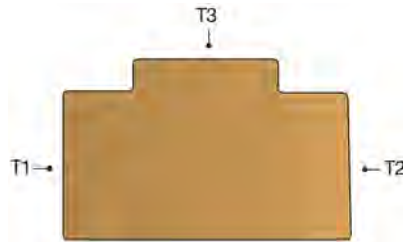

Part No.	Desc.	Standard Pack			Standard Pack
		T1 (in)	T2 (in)	T3 (in)	
G60695-0202	2FI-2FI-2FI	5/16-28	5/16-28	5/16-28	1
G60695-0303	3FI-3FI-3FI	3/8-24	3/8-24	3/8-24	1
G60695-0404	4FI-4FI-4FI	7/16-24	7/16-24	7/16-24	1
G60695-0505	5FI-5FI-5FI	1/2-20	1/2-20	1/2-20	1
G60695-0606	6FI-6FI-6FI	5/8-18	5/8-18	5/8-18	1
G60695-0808	8FI-8FI-8FI	3/4-18	3/4-18	3/4-18	1
G60695-1414	14FI-14FI-14FI	1 3/16-16	1 3/16-16	1 3/16-16	1

- AIR BRAKE NYLON TUBING
- AIR BRAKE COPPER TUBING
- AIR BRAKE SURELOK
- COMPOSITE AIR BRAKE SURELOK
- AIR BRAKE COMPRESSION FITTINGS
- AIR BRAKE COUPLINGS FOR RUBBER HOSE
- VALVES
- BRASS LOCK-ON FIELD ATTACHABLE COUPLINGS
- SINGLE BEAD
- BARB STEM
- INVERTED FLARE**
- AUTOMOTIVE ADAPTERS
- COPPER TUBING INDUSTRIAL COMPRESSION
- INDUSTRIAL SURELOK
- MINI-BARBED TUBE
- POLY INDUSTRIAL COMPRESSION
- PIPE ADAPTERS
- ADAPTERS SAE FLARE
- THREADED SLEEVE
- KITS & ASSORTMENTS

Female Inverted Branch Tee to Female Pipe

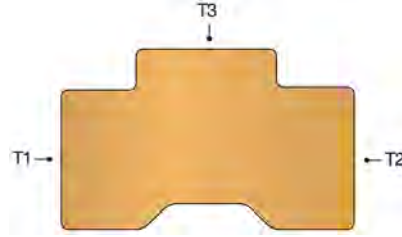

Part No.	Desc.				Standard Pack
		T1 (in)	T2 (in)	T3 (in)	
G60696-0303	3FI-3FI-3FP	3/8-24	3/8-24	1/8-27	1
G60696-0402	4FI-4FI-2FP	7/16-24	7/16-24	1/8-27	1
G60696-0404	4FI-4FI-4FP	7/16-24	7/16-24	1/4-18	1
G60696-0505	5FI-5FI-5FP	1/2-20	1/2-20	1/8-27	1
G60696-0604	6FI-6FI-4FP	5/8-18	5/8-18	1/4-18	1
G60696-0808	8FI-8FI-8FP	3/4-18	3/4-18	1/2-14	1

- AIR BRAKE NYLON TUBING
- AIR BRAKE COPPER TUBING
- AIR BRAKE SURELOK
- COMPOSITE AIR BRAKE SURELOK
- AIR BRAKE COMPRESSION FITTINGS
- AIR BRAKE COUPLINGS FOR RUBBER HOSE
- VALVES
- BRASS LOCK-ON FIELD ATTACHABLE COUPLINGS
- SINGLE BEAD
- BARB STEM
- INVERTED FLARE**
- AUTOMOTIVE ADAPTERS
- COPPER TUBING INDUSTRIAL COMPRESSION
- INDUSTRIAL SURELOK
- MINI-BARBED TUBE
- POLY INDUSTRIAL COMPRESSION
- PIPE ADAPTERS
- ADAPTERS SAE FLARE
- THREADED SLEEVE
- KITS & ASSORTMENTS

Recommended For: Adapting automotive oil filters, carburetors, power steering and fuel lines such as fuel injection, transmission oil cooler and drain plugs. Also, used to adapt brake lines to port configurations found in master cylinders or for adapting brake lines to metric sizes.

Used With: Aluminum, brass, copper and steel tubing

Features and Benefits: Robust construction with metal to metal seats for high heat and fluid compatibility.

Conformance: SAE, ASME

Working Pressure: 2,000 psi (136 bar)

Temperature Range: -30°F to +250°F (-34°C to +121°C)

Material: 360 Brass

AIR BRAKE
NYLON TUBING

AIR BRAKE
COPPER TUBING

AIR BRAKE
SURELOK

COMPOSITE AIR
BRAKE SURELOK

AIR BRAKE
COMPRESSION
FITTINGS

AIR BRAKE
COUPLINGS FOR
RUBBER HOSE

VALVES

BRASS LOCK-ON
FIELD
ATTACHABLE
COUPLINGS

SINGLE BEAD

BARB STEM

INVERTED FLARE

AUTOMOTIVE
ADAPTERS

COPPER TUBING
INDUSTRIAL
COMPRESSION

INDUSTRIAL
SURELOK

MINI-BARBED
TUBE

POLY
INDUSTRIAL
COMPRESSION

PIPE ADAPTERS

ADAPTERS SAE
FLARE

THREADED
SLEEVE

KITS &
ASSORTMENTS

Turbo Charger Connector

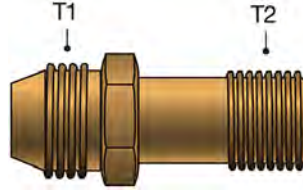

Part No.	Desc.			Standard Pack
		T1 (in)	T2 (in)	
G49200-1612		30 Tube	3/4-12	1

Ford Nut

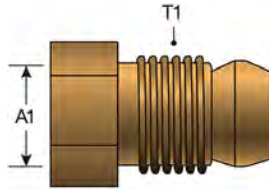

Part No.	Desc.	A1		Standard Pack
		"	T1 (in)	
G49230-0404		1/4	1/2-20	1

Carburetor to Fuel Line Adapter (Ford)



Part No.	Desc.			Standard Pack
		T1 (in)	T2 (in)	
G49240-0204	2MPFLA-8MI	1/8-27	1/2-20	1

- AIR BRAKE NYLON TUBING
- AIR BRAKE COPPER TUBING
- AIR BRAKE SURELOK
- COMPOSITE AIR BRAKE SURELOK
- AIR BRAKE COMPRESSION FITTINGS
- AIR BRAKE COUPLINGS FOR RUBBER HOSE
- VALVES
- BRASS LOCK-ON FIELD ATTACHABLE COUPLINGS
- SINGLE BEAD
- BARB STEM
- INVERTED FLARE
- AUTOMOTIVE ADAPTERS
- COPPER TUBING INDUSTRIAL COMPRESSION
- INDUSTRIAL SURELOK
- MINI-BARBED TUBE
- POLY INDUSTRIAL COMPRESSION
- PIPE ADAPTERS
- ADAPTERS SAE FLARE
- THREADED SLEEVE
- KITS & ASSORTMENTS

Fuel Line Adapter (Plymouth)

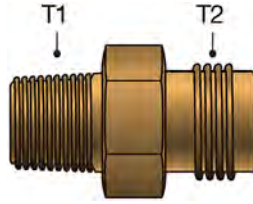

Part No.	Desc.	T1 (in)		Standard Pack
		T1 (in)	T2 (in)	
G49250-0205		1/8-27	1/2-20	1

Carburetor Inlet - Steel

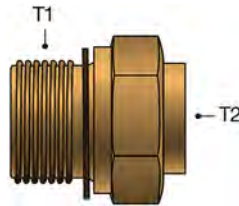

Part No.	Desc.	T1 (in)		Standard Pack
		T1 (in)	T2 (in)	
G49251-0514		1/2-20	7/8-20	1
G49251-0614		5/8-18	7/8-20	1

Towed Trailer Brake - Tee

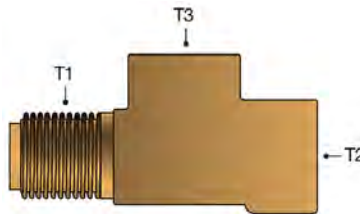



Part No.	Desc.	T1 (in)			Standard Pack
		T1 (in)	T2 (in)	T3 (in)	
G49300-0303		3/8-24	3/8-24	3/8-24	1
G49300-0305		1/2-20	1/2-20	3/8-24	1
G49300-0403		7/16-24	7/16-24	3/8-24	1
G49300-0404		7/16-24	7/16-24	7/16-24	1
G49301-0303		9/16-18	3/8-24	9/16-18	1
G49301-0304		7/16-24	7/16-24	3/8-24	1
G49301-0403		9/16-18	3/8-24	9/16-18	1
G49302-0303		9/16-20	3/8-24	9/16-20	1
G49303-0403		3/8-24	3/8-24	7/16-24	1

- AIR BRAKE NYLON TUBING
- AIR BRAKE COPPER TUBING
- AIR BRAKE SURELOK
- COMPOSITE AIR BRAKE SURELOK
- AIR BRAKE COMPRESSION FITTINGS
- AIR BRAKE COUPLINGS FOR RUBBER HOSE
- VALVES
- BRASS LOCK-ON FIELD ATTACHABLE COUPLINGS
- SINGLE BEAD
- BARB STEM
- INVERTED FLARE
- AUTOMOTIVE ADAPTERS**
- COPPER TUBING INDUSTRIAL COMPRESSION
- INDUSTRIAL SURELOK
- MINI-BARBED TUBE
- POLY INDUSTRIAL COMPRESSION
- PIPE ADAPTERS
- ADAPTERS SAE FLARE
- THREADED SLEEVE
- KITS & ASSORTMENTS

AIR BRAKE NYLON TUBING
AIR BRAKE COPPER TUBING
AIR BRAKE SURELOK
COMPOSITE AIR BRAKE SURELOK
AIR BRAKE COMPRESSION FITTINGS
AIR BRAKE COUPLINGS FOR RUBBER HOSE
VALVES
BRASS LOCK-ON FIELD ATTACHABLE COUPLINGS
SINGLE BEAD
BARB STEM
INVERTED FLARE
AUTOMOTIVE ADAPTERS
COPPER TUBING INDUSTRIAL COMPRESSION
INDUSTRIAL SURELOK
MINI-BARBED TUBE
POLY INDUSTRIAL COMPRESSION
PIPE ADAPTERS
ADAPTERS SAE FLARE
THREADED SLEEVE
KITS & ASSORTMENTS

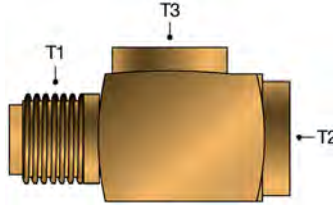
Metric Towed Trailer Brake - Tee



Part No.	Desc.				Standard Pack
		T1 (in)	T2 (in)	T3 (in)	
G49304-1203		M12X1.0	M12X1.0	3/8-24	1
G49304-1303		M13X1.5	M13X1.5	3/8-24	1
G49305-1203		M12X1.0	M12X1.0	3/8-24	1

Hydraulic Brake Strap Assembly - Tee

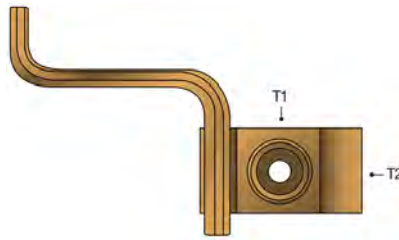

Part No.	Desc.			Standard Pack
		T1 (in)	T2 (in)	
G49310-0303		3/8-24	3/8-24	1
G49310-0404		9/16-18	9/16-18	1
G49312-0304		3/8-24	9/16-18	1

Hydraulic Brake - Block

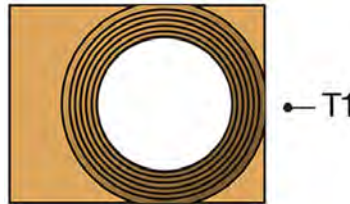

Part No.	Desc.		Standard Pack
		T1 (in)	
G49313-0004		7/16-24	1

Hydraulic Brake with Bolt Hole - Tee

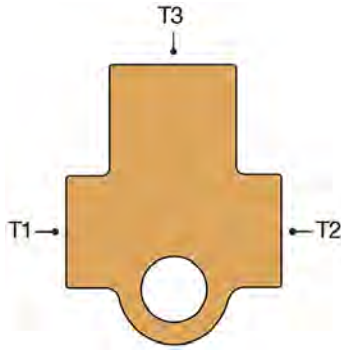

Part No.	Desc.	🌀			Standard Pack
		T1 (in)	T2 (in)	T3 (in)	
G49314-0306		3/8-24	3/8-24	5/8-18	1

Metric Hydraulic Brake Adapter - Male Inverted to Tube O.D. Female

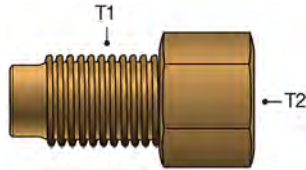

Part No.	Desc.	🌀		Standard Pack
		T1 (in)	T2 (in)	
G49320-1003		M10X1.0	3/8-24	1

Metric Hydraulic Brake Adapter - Male Bubble to Tube O.D. Female

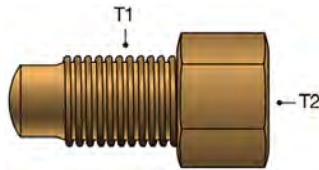

Part No.	Desc.	🌀		Standard Pack
		T1 (in)	T2 (in)	
G49321-1003		M10X1.0	3/8-24	1
G49321-1110	11MMHBA-10FMHBA	M11X1.5	M10X1.0	1
G49321-1210		M12X1.0	M10X1.0	1
G49321-1310		M13X1.0	M10X1.0	1

- AIR BRAKE NYLON TUBING
- AIR BRAKE COPPER TUBING
- AIR BRAKE SURELOK
- COMPOSITE AIR BRAKE SURELOK
- AIR BRAKE COMPRESSION FITTINGS
- AIR BRAKE COUPLINGS FOR RUBBER HOSE
- VALVES
- BRASS LOCK-ON FIELD ATTACHABLE COUPLINGS
- SINGLE BEAD
- BARB STEM
- INVERTED FLARE
- AUTOMOTIVE ADAPTERS**
- COPPER TUBING INDUSTRIAL COMPRESSION
- INDUSTRIAL SURELOK
- MINI-BARBED TUBE
- POLY INDUSTRIAL COMPRESSION
- PIPE ADAPTERS
- ADAPTERS SAE FLARE
- THREADED SLEEVE
- KITS & ASSORTMENTS

Metric Hydraulic Brake Adapter - Bubble

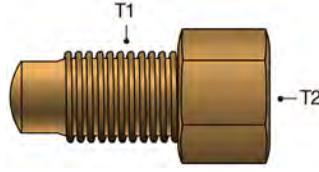

Part No.	Desc.			Standard Pack
		T1 (in)	T2 (in)	
G49323-0310		3/8-24	M10X1.25	1

Metric Hydraulic Brake Adapter - British Bubble

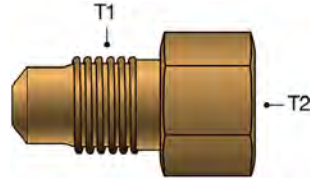

Part No.	Desc.			Standard Pack
		T1 (in)	T2 (in)	
G49324-0304		3/8-24	7/16-20	1

Standard to Metric

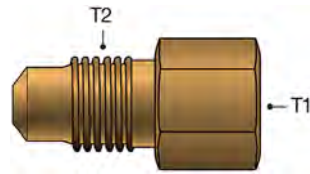

Part No.	Desc.			Standard Pack
		T1 (in)	T2 (in)	
G49325-1103		3/8-24	11X1.5	1
G49325-1203		3/8-24	12X1.0	1
G49325-1303		3/8-24	13X1.0	1

- AIR BRAKE NYLON TUBING
- AIR BRAKE COPPER TUBING
- AIR BRAKE SURELOK
- COMPOSITE AIR BRAKE SURELOK
- AIR BRAKE COMPRESSION FITTINGS
- AIR BRAKE COUPLINGS FOR RUBBER HOSE
- VALVES
- BRASS LOCK-ON FIELD ATTACHABLE COUPLINGS
- SINGLE BEAD
- BARB STEM
- INVERTED FLARE
- AUTOMOTIVE ADAPTERS
- COPPER TUBING INDUSTRIAL COMPRESSION
- INDUSTRIAL SURELOK
- MINI-BARBED TUBE
- POLY INDUSTRIAL COMPRESSION
- PIPE ADAPTERS
- ADAPTERS SAE FLARE
- THREADED SLEEVE
- KITS & ASSORTMENTS

Adapter Standard to Metric Bubble

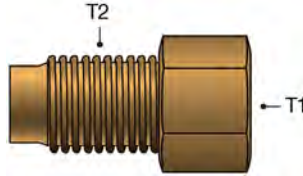

Part No.	Desc.			Standard Pack
		T1 (in)	T2 (in)	
G49326-1003		3/8-24	10X1.25	1

Hydraulic Brake Metric Union

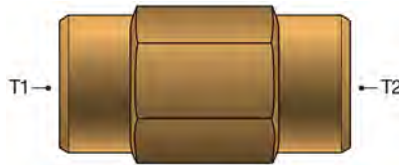

Part No.	Desc.			Standard Pack
		T1 (in)	T2 (in)	
G49400-1010		3/8-24	M10X1.0	1

Hydraulic Brake Union - British



Part No.	Desc.			Standard Pack
		T1 (in)	T2 (in)	
G49401-0303		3/8-24	3/8-24	1

- AIR BRAKE NYLON TUBING
- AIR BRAKE COPPER TUBING
- AIR BRAKE SURELOK
- COMPOSITE AIR BRAKE SURELOK
- AIR BRAKE COMPRESSION FITTINGS
- AIR BRAKE COUPLINGS FOR RUBBER HOSE
- VALVES
- BRASS LOCK-ON FIELD ATTACHABLE COUPLINGS
- SINGLE BEAD
- BARB STEM
- INVERTED FLARE
- AUTOMOTIVE ADAPTERS**
- COPPER TUBING INDUSTRIAL COMPRESSION
- INDUSTRIAL SURELOK
- MINI-BARBED TUBE
- POLY INDUSTRIAL COMPRESSION
- PIPE ADAPTERS
- ADAPTERS SAE FLARE
- THREADED SLEEVE
- KITS & ASSORTMENTS

AIR BRAKE NYLON TUBING
AIR BRAKE COPPER TUBING
AIR BRAKE SURELOK
COMPOSITE AIR BRAKE SURELOK
AIR BRAKE COMPRESSION FITTINGS
AIR BRAKE COUPLINGS FOR RUBBER HOSE
VALVES
BRASS LOCK-ON FIELD ATTACHABLE COUPLINGS
SINGLE BEAD
BARB STEM
INVERTED FLARE
AUTOMOTIVE ADAPTERS
COPPER TUBING INDUSTRIAL COMPRESSION
INDUSTRIAL SURELOK
MINI-BARBED TUBE
POLY INDUSTRIAL COMPRESSION
PIPE ADAPTERS
ADAPTERS SAE FLARE
THREADED SLEEVE
KITS & ASSORTMENTS

Hydraulic Brake Union - European

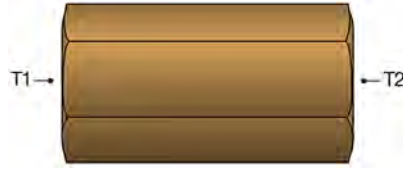

Part No.	Desc.			Standard Pack
		T1 (in)	T2 (in)	
G49402-1010		M10X1.0	M10X1.0	1

Hydraulic Brake Union - Japanese



Part No.	Desc.			Standard Pack
		T1 (in)	T2 (in)	
G49403-1010		M10X1.0	M10X1.0	1

Dual Master Cylinder Adapter

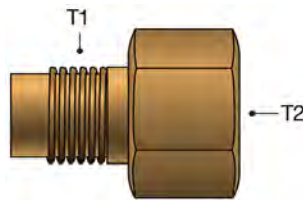

Part No.	Desc.			Standard Pack
		T1 (in)	T2 (in)	
G49500-0304		7/16-24	3/8-24	1
G49500-0405		1/2-20	7/16-24	1
G49500-0503		3/8-24	1/2-20	1
G49500-0504		7/16-24	1/2-20	1
G49500-0506		5/8-18	1/2-20	1
G49500-0605		1/2-20	5/8-18	1
G49501-0303		9/16-18	9/16-18	1
G49501-0404		7/16-24	9/16-18	1
G49501-0503		1/2-20	3/8-24	1
G49502-0303		1/2-20	9/16-18	1
G49502-0503		9/16-18	1/2-20	1
G49503-0303		3/8-24	9/16-18	1
G49504-0303		3/8-24	9/16-18	1
G49505-0403		3/8-24	7/16-24	1
G49505-0404		7/16-24	7/16-20	1
G49505-0503		3/8-24	1/2-20	1

Dual Master Cylinder Adapter - Continued

Part No.	Desc.			Standard Pack
		T1 (in)	T2 (in)	
G49505-0504		7/16-24	1/2-20	1
G49505-0505		1/2-20	1/2-20	1
G49506-0605		1/2-20	3/8-18	1
G49507-0303		3/8-24	3/8-24	1
G49507-0503		3/8-24	1/2-20	1

JIC 37° Flare Power Steering Adapter

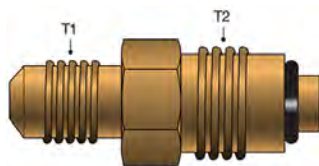

Part No.	Desc.			Standard Pack
		T1 (in)	T2 (in)	
G49700-0504		7/16-20	9/16-18	1
G49700-0606		9/16-18	5/8-18	1

Ford Power Steering Adapter

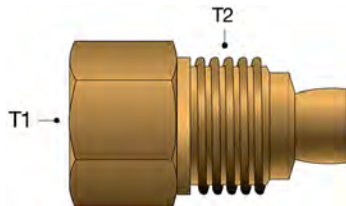

Part No.	Desc.			Standard Pack
		T1 (in)	T2 (in)	
G49701-0406		5/8-18	11/16-18	1

Metric Power Steering Adapter

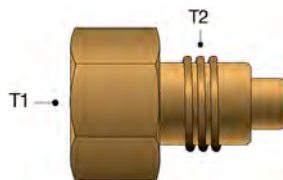

Part No.	Desc.			Standard Pack
		T1 (in)	T2 (in)	
G49702-1406		5/8-18	M14X1.5	1

- AIR BRAKE NYLON TUBING
- AIR BRAKE COPPER TUBING
- AIR BRAKE SURELOK
- COMPOSITE AIR BRAKE SURELOK
- AIR BRAKE COMPRESSION FITTINGS
- AIR BRAKE COUPLINGS FOR RUBBER HOSE
- VALVES
- BRASS LOCK-ON FIELD ATTACHABLE COUPLINGS
- SINGLE BEAD
- BARB STEM
- INVERTED FLARE
- AUTOMOTIVE ADAPTERS
- COPPER TUBING INDUSTRIAL COMPRESSION
- INDUSTRIAL SURELOK
- MINI-BARBED TUBE
- POLY INDUSTRIAL COMPRESSION
- PIPE ADAPTERS
- ADAPTERS SAE FLARE
- THREADED SLEEVE
- KITS & ASSORTMENTS

Metric Power Steering Adapter - Continued

Part No.	Desc.			Standard Pack
		T1 (in)	T2 (in)	
G49702-1606		5/8-18	M16X1.5	1
G49702-1806		5/8-18	M18X1.5	1

Transmission Oil Cooler Line Adapter



Part No.	Desc.	A1		Standard Pack
		"	T1 (in)	
G49800-0505		5/16	1/2-20	1
G49800-0606		3/8	5/8-18	1

Air Conditioning Adapter

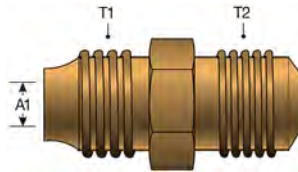

Part No.	Desc.	A1			Standard Pack
		"	T1 (in)	T2 (in)	
G49900-0404	4ACADAPTER-7MS	1/4	7/16-20	7/16-20	1

Male SAE 45° - Male Inverted

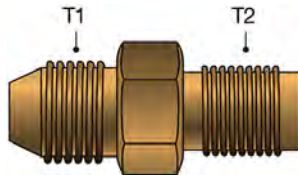

Part No.	Desc.			Standard Pack
		T1 (in)	T2 (in)	
G49901-0605		5/8-18	1/2-20	1
G49901-0607		5/8-18	11/16-18	1
G60679-0403	4MS-3MI	7/16-20	3/8-24	1
G60679-0404	4MS-4MI	7/16-20	7/16-24	1

Tube O.D. (in)	1/8	3/16	1/4	5/16	3/8	7/16	1/2	5/8	3/4	1
Thread Size	5/16-24	3/8-24	7/16-24	1/2-24	9/16-24	5/8-24	11/16-20	13/16-18	1-18	1-1/4-18
PSI	2800	1900	1400	1200	1000	875	750	650	550	350

Recommended For: Hydraulic and pneumatic systems

Used With: Copper, aluminum, and plastic tubing

Features and Benefits: Provides a low cost, easy to assemble solution that does not require flaring.

Working Pressure: Up to 2,800 psi depending on the tube size. See chart above.

Temperature Range: -65°F to +250°F (-53° to +121°C)

Material: 360 Brass

Assembly Instructions:

1. Measure tube and cut to the desired length. Ensure there are no burrs on the tubing.
2. Slide nut and then sleeve onto the tube. Threaded end of nut must face connector.
3. Insert tube into the connector body until the tubing bottoms out on the connector shoulder.
4. Lubricate the threads and assemble the nut to the connector body.
5. Hand-tighten the threads, then continue tighten with a wrench to the number of turns listed in the chart below.

Tube Size	Turns from Hand Tight
1/8" to 1/4"	1-1/4
5/16"	1-3/4
3/8" to 1"	2-1/4

AIR BRAKE
NYLON TUBING

AIR BRAKE
COPPER TUBING

AIR BRAKE
SURELOK

COMPOSITE AIR
BRAKE SURELOK

AIR BRAKE
COMPRESSION
FITTINGS

AIR BRAKE
COUPLINGS FOR
RUBBER HOSE

VALVES

BRASS LOCK-ON
FIELD
ATTACHABLE
COUPLINGS

SINGLE BEAD

BARB STEM

INVERTED FLARE

AUTOMOTIVE
ADAPTERS

COPPER TUBING
INDUSTRIAL
COMPRESSION

INDUSTRIAL
SURELOK

MINI-BARBED
TUBE

POLY
INDUSTRIAL
COMPRESSION

PIPE ADAPTERS

ADAPTERS SAE
FLARE

THREADED
SLEEVE

KITS &
ASSORTMENTS

Copper Tubing Industrial to Male Pipe - Check Valve

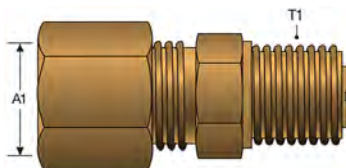

Part No.	Desc.	A1		Standard Pack
		"	T1 (in)	
G55028-0302	3CTI-2MP-CV	3/16	1/8-27	1
G55028-0402	4CTI-2MP-CV	1/4	1/8-27	1
G55028-0502	5CTI-2MP-CV	5/16	1/8-27	1
G55028-0604	6CTI-4MP-CV	3/8	1/4-18	1

Nut - Long

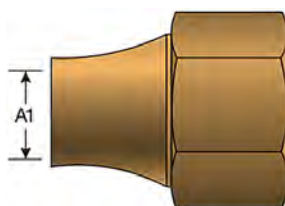

Part No.	Desc.	A1	Standard Pack
		"	
G55030-0003	3TN-CTI-L	3/16	5
G55030-0004	4TN-CTI-L	1/4	5
G55030-0005	5TN-CTI-L	5/16	1
G55030-0006	6TN-CTI-L	3/8	1
G55030-0008	8TN-CTI-L	1/2	1
G55030-0010	10TN-CTI-L	5/8	1
G55030-0012	12TN-CTI-L	3/4	1
G55030-0016	16TN-CTI-L	1	1

Tube Sleeve Insert



Part No.	Desc.	A1	Standard Pack
		"	
G55040-0004	4TSI-CTI	1/4	5
G55040-0004T	4TSI-CTI	1/4	5
G55040-0005	5TSI-CTI	5/16	1
G55040-0006	6TSI-CTI	3/8	1
G55040-0008	8TSI-CTI	1/2	1
G55040-0010	10TSI-CTI	5/8	1
G55040-0012	12TSI-CTI	3/4	1
G55040-0016	16TSI-CTI	1	1

Tube Sleeve

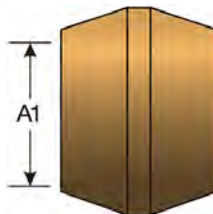

Part No.	Desc.	A1	Standard Pack
		"	
G55050-0002	2TS-CTI	1/8	5
G55050-0003	3TS-CTI	3/16	5
G55050-0004	4TS-CTI	1/4	5
G55050-0005	5TS-CTI	5/16	1
G55050-0006	6TS-CTI	3/8	1
G55050-0007	7TS-CTI	7/16	1
G55050-0008	8TS-CTI	1/2	1
G55050-0010	10TS-CTI	5/8	1
G55050-0012	12TS-CTI	3/4	1
G55050-0016	16TS-CTI	1	1

Tube Sleeve Nut

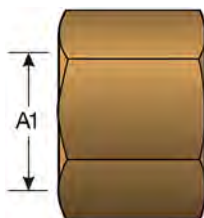

Part No.	Desc.	A1	Standard Pack
		"	
G55060-0002	2TSN-CTI	1/8	5
G55060-0003	3TSN-CTI	3/16	5
G55060-0004	4TSN-CTI	1/4	5
G55060-0005	5TSN-CTI	5/16	1
G55060-0006	6TSN-CTI	3/8	1
G55060-0007	7TSN-CTI	7/16	1
G55060-0008	8TSN-CTI	1/2	1
G55060-0010	10TSN-CTI	5/8	1
G55060-0012	12TSN-CTI	3/4	1

AIR BRAKE
NYLON TUBING

AIR BRAKE
COPPER TUBING

AIR BRAKE
SURELOK

COMPOSITE AIR
BRAKE SURELOK

AIR BRAKE
COMPRESSION
FITTINGS

AIR BRAKE
COUPLINGS FOR
RUBBER HOSE

VALVES

BRASS LOCK-ON
FIELD
ATTACHABLE
COUPLINGS

SINGLE BEAD

BARB STEM

INVERTED FLARE

AUTOMOTIVE
ADAPTERS

COPPER TUBING
INDUSTRIAL
COMPRESSION

INDUSTRIAL
SURELOK

MINI-BARBED
TUBE

POLY
INDUSTRIAL
COMPRESSION

PIPE ADAPTERS

ADAPTERS SAE
FLARE

THREADED
SLEEVE

KITS &
ASSORTMENTS

Copper Tubing Industrial to Male Pipe

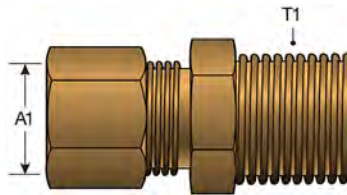

Part No.	Desc.	A1		Standard Pack
		"	T1 (in)	
G55100-0201	2CTI-1MP	1/8	1/16-32	1
G55100-0202	2CTI-2MP	1/8	1/8-27	1
G55100-0302	3CTI-2MP	3/16	1/8-27	1
G55100-0304	3CTI-4MP	3/16	1/4-18	1
G55100-0402	4CTI-2MP	1/4	1/8-27	1
G55100-0404	4CTI-4MP	1/4	1/4-18	1
G55100-0502	5CTI-2MP	5/16	1/8-27	1
G55100-0504	5CTI-4MP	5/16	1/4-18	1
G55100-0602	6CTI-2MP	3/8	1/8-27	1
G55100-0604	6CTI-4MP	3/8	1/4-18	1
G55100-0606	6CTI-6MP	3/8	3/8-18	1
G55100-0608	6CTI-8MP	3/8	1/2-14	1
G55100-0704	7CTI-4MP	7/16	1/4-18	1
G55100-0804	8CTI-4MP	1/2	1/4-18	1
G55100-0806	8CTI-6MP	1/2	3/8-18	1
G55100-0808	8CTI-8MP	1/2	1/2-14	1
G55100-1008	10CTI-8MP	5/8	1/2-14	1
G55100-1208	12CTI-8MP	3/4	1/2-14	1
G55100-1212	12CTI-12MP	3/4	3/4-14	1

Copper Tubing Industrial to Male Pipe - 90°

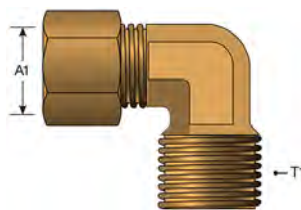



Part No.	Desc.	A1		Standard Pack
		"	T1 (in)	
G55104-0201	2CTI-1MP90	1/8	1/16-32	1
G55104-0202	2CTI-2MP90	1/8	1/8-27	1
G55104-0302	3CTI-2MP90	3/16	1/8-27	1
G55104-0402	4CTI-2MP90	1/4	1/8-27	1
G55104-0404	4CTI-4MP90	1/4	1/4-18	1
G55104-0502	5CTI-2MP90	5/16	1/8-27	1
G55104-0504	5CTI-4MP90	5/16	1/4-18	1
G55104-0602	6CTI-2MP90	3/8	1/8-27	1
G55104-0604	6CTI-4MP90	3/8	1/4-18	1
G55104-0606	6CTI-6MP90	3/8	3/8-18	1
G55104-0608	6CTI-8MP90	3/8	1/2-14	1
G55104-0704	7CTI-4MP90	7/16	1/4-18	1
G55104-0804	8CTI-4MP90	1/2	1/4-18	1

Copper Tubing Industrial to Male Pipe - 90° - Continued

Part No.	Desc.	A1		Standard Pack
		"	T1 (in)	
G55104-0806	8CTI-6MP90	1/2	3/8-18	1
G55104-0808	8CTI-8MP90	1/2	1/2-14	1
G55104-1008	10CTI-8MP90	5/8	1/2-14	1
G55104-1208	12CTI-8MP90	3/4	1/2-14	1
G55104-1212	12CTI-12MP90	3/4	3/4-14	1

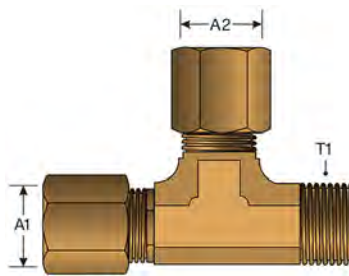
Copper Tubing Industrial Run Tee to Male Pipe



Part No.	Desc.	A1	A2		Standard Pack
		"	"	T1 (in)	
G55130-0203	2MP-3CTI-3CTI	3/16	3/16	1/8-27	1
G55130-0204	2MP-4CTI-4CTI	1/4	1/4	1/8-27	1
G55130-0205	2MP-5CTI-5CTI	5/16	5/16	1/8-27	1
G55130-0404	4MP-4CTI-4CTI	1/4	1/4	1/4-18	1
G55130-0406	4MP-6CTI-6CTI	3/8	3/8	1/4-18	1
G55130-0608	6MP-8CTI-8CTI	1/2	1/2	3/8-18	1

Copper Tubing Industrial Branch Tee to Male Pipe

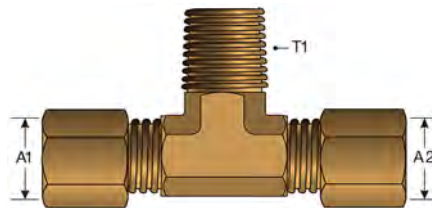

Part No.	Desc.	A1	A2		Standard Pack
		"	"	T1 (in)	
G55134-0302	3CTI-3CTI-2MP	3/16	3/16	1/8-27	1
G55134-0402	4CTI-4CTI-2MP	1/4	1/4	1/8-27	1
G55134-0404	4CTI-4CTI-4MP	1/4	1/4	1/4-18	1
G55134-0502	5CTI-5CTI-2MP	5/16	5/16	1/8-27	1
G55134-0604	6CTI-6CTI-4MP	3/8	3/8	1/4-18	1
G55134-0806	8CTI-8CTI-6MP	1/2	1/2	3/8-18	1

- AIR BRAKE NYLON TUBING
- AIR BRAKE COPPER TUBING
- AIR BRAKE SURELOK
- COMPOSITE AIR BRAKE SURELOK
- AIR BRAKE COMPRESSION FITTINGS
- AIR BRAKE COUPLINGS FOR RUBBER HOSE
- VALVES
- BRASS LOCK-ON FIELD ATTACHABLE COUPLINGS
- SINGLE BEAD
- BARB STEM
- INVERTED FLARE
- AUTOMOTIVE ADAPTERS
- COPPER TUBING INDUSTRIAL COMPRESSION
- INDUSTRIAL SURELOK
- MINI-BARBED TUBE
- POLY INDUSTRIAL COMPRESSION
- PIPE ADAPTERS
- ADAPTERS SAE FLARE
- THREADED SLEEVE
- KITS & ASSORTMENTS

Copper Tubing Industrial to Female Pipe

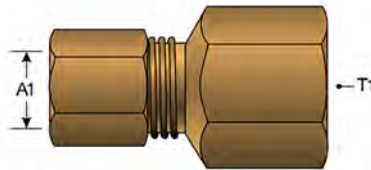

Part No.	Desc.	A1		Standard Pack
		"	T1 (in)	
G55150-0202	2CTI-2FP	1/8	1/8-27	1
G55150-0302	3CTI-2FP	3/16	1/8-27	1
G55150-0402	4CTI-2FP	1/4	1/8-27	1
G55150-0404	4CTI-4FP	1/4	1/4-18	1
G55150-0502	5CTI-2FP	5/16	1/8-27	1
G55150-0504	5CTI-4FP	5/16	1/4-18	1
G55150-0602	6CTI-2FP	3/8	1/8-27	1
G55150-0604	6CTI-4FP	3/8	1/4-18	1
G55150-0806	8CTI-6FP	1/2	3/8-18	1
G55150-1008	10CTI-8FP	5/8	1/2-14	1

Copper Tubing Industrial to Female Pipe - 90°

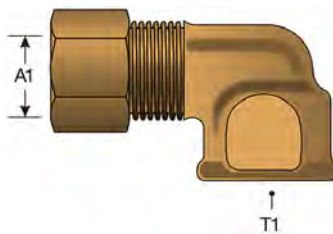

Part No.	Desc.	A1		Standard Pack
		"	T1 (in)	
G55154-0302	3CTI-2FP90	3/16	1/8-27	1
G55154-0402	4CTI-2FP90	1/4	1/8-27	1
G55154-0502	5CTI-2FP90	5/16	1/8-27	1
G55154-0604	6CTI-4FP90	3/8	1/4-18	1
G55154-0806	8CTI-6FP90	1/2	3/8-18	1
G55154-1008	10CTI-8FP90	5/8	1/2-14	1

AIR BRAKE NYLON TUBING
 AIR BRAKE COPPER TUBING
 AIR BRAKE SURELOK
 COMPOSITE AIR BRAKE SURELOK
 AIR BRAKE COMPRESSION FITTINGS
 AIR BRAKE COUPLINGS FOR RUBBER HOSE
 VALVES
 BRASS LOCK-ON FIELD ATTACHABLE COUPLINGS
 SINGLE BEAD
 BARB STEM
 INVERTED FLARE
 AUTOMOTIVE ADAPTERS
 COPPER TUBING INDUSTRIAL COMPRESSION
 INDUSTRIAL SURELOK
 MINI-BARBED TUBE
 POLY INDUSTRIAL COMPRESSION
 PIPE ADAPTERS
 ADAPTERS SAE FLARE
 THREADED SLEEVE
 KITS & ASSORTMENTS

Copper Tubing Industrial to Male Pipe to Female Pipe Run Tee

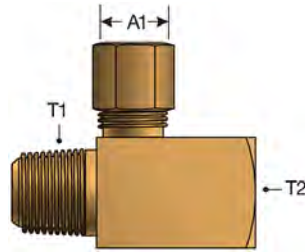

Part No.	Desc.	A1	T		Standard Pack
		"	T1 (in)	T2 (in)	
G55161-0203	2MP-2FP-3CTI	3/16	1/8-27	1/8-27	1
G55161-0204	2MP-2FP-4CTI	1/4	1/8-27	1/8-27	1

Copper Tubing Industrial Bulkhead Union

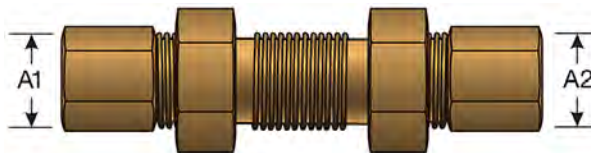

Part No.	Desc.	A1	A2	Standard Pack
		"	"	
G55300-0404	4CTI-4CTI-BKHD	1/4	1/4	1
G55300-0505	5CTI-5CTI-BKHD	5/16	5/16	1
G55300-0606	6CTI-6CTI-BKHD	3/8	3/8	1
G55300-0808	8CTI-8CTI-BKHD	1/2	1/2	1

Copper Tubing Industrial Union

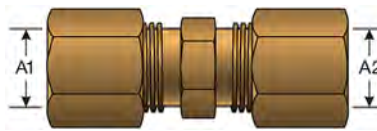

Part No.	Desc.	A1	A2	Standard Pack
		"	"	
G55400-0202	2CTI-2CTI	1/8	1/8	1
G55400-0303	3CTI-3CTI	3/16	3/16	1
G55400-0404	4CTI-4CTI	1/4	1/4	1
G55400-0505	5CTI-5CTI	5/16	5/16	1
G55400-0606	6CTI-6CTI	3/8	3/8	1
G55400-0808	8CTI-8CTI	1/2	1/2	1
G55400-1010	10CTI-10CTI	5/8	5/8	1
G55400-1212	12CTI-12CTI	3/4	3/4	1

AIR BRAKE
NYLON TUBING

AIR BRAKE
COPPER TUBING

AIR BRAKE
SURELOK

COMPOSITE AIR
BRAKE SURELOK

AIR BRAKE
COMPRESSION
FITTINGS

AIR BRAKE
COUPLINGS FOR
RUBBER HOSE

VALVES

BRASS LOCK-ON
FIELD
ATTACHABLE
COUPLINGS

SINGLE BEAD

BARB STEM

INVERTED FLARE

AUTOMOTIVE
ADAPTERS

COPPER TUBING
INDUSTRIAL
COMPRESSION

INDUSTRIAL
SURELOK

MINI-BARBED
TUBE

POLY
INDUSTRIAL
COMPRESSION

PIPE ADAPTERS

ADAPTERS SAE
FLARE

THREADED
SLEEVE

KITS &
ASSORTMENTS

- AIR BRAKE NYLON TUBING
- AIR BRAKE COPPER TUBING
- AIR BRAKE SURELOK
- COMPOSITE AIR BRAKE SURELOK
- AIR BRAKE COMPRESSION FITTINGS
- AIR BRAKE COUPLINGS FOR RUBBER HOSE
- VALVES
- BRASS LOCK-ON FIELD ATTACHABLE COUPLINGS
- SINGLE BEAD
- BARB STEM
- INVERTED FLARE
- AUTOMOTIVE ADAPTERS
- COPPER TUBING INDUSTRIAL COMPRESSION
- INDUSTRIAL SURELOK
- MINI-BARBED TUBE
- POLY INDUSTRIAL COMPRESSION
- PIPE ADAPTERS
- ADAPTERS SAE FLARE
- THREADED SLEEVE
- KITS & ASSORTMENTS

Copper Tubing Industrial Union - 90°

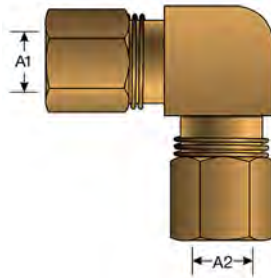

Part No.	Desc.	A1	A2	Standard Pack
		"	"	
G55404-0303	3CTI-3CTI90	3/16	3/16	1
G55404-0404	4CTI-4CTI90	1/4	1/4	1
G55404-0505	5CTI-5CTI90	5/16	5/16	1
G55404-0606	6CTI-6CTI90	3/8	3/8	1
G55404-0808	8CTI-8CTI90	1/2	1/2	1

Copper Tubing Industrial Union - Tee

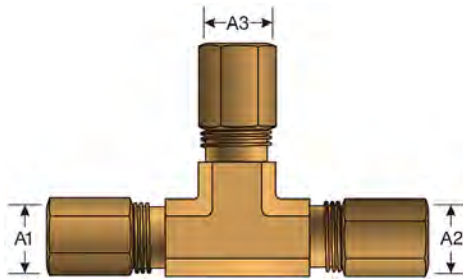

Part No.	Desc.	A1	A2	A3	Standard Pack
		"	"	"	
G55450-0303	3CTI-3CTI-3CTI	3/16	3/16	3/16	1
G55450-0404	4CTI-4CTI-4CTI	1/4	1/4	1/4	1
G55450-0505	5CTI-5CTI-5CTI	5/16	5/16	5/16	1
G55450-0606	6CTI-6CTI-6CTI	3/8	3/8	3/8	1
G55450-0808	8CTI-8CTI-8CTI	1/2	1/2	1/2	1

Recommended For: Compressed air, pneumatic applications, lubrication and cooling lines.

Used With: Nylon, polyethylene, and plastic tubing

Features and Benefits: No tools required resulting in an easy to assemble component, time savings, and fewer installation errors.

Working Pressure: Up to 250 psi

Temperature Range: -40°F to +175°F (-40°C to +80°C)

Material: Nickel plated 360 Brass (Body); silicone-free nitrile (O-Ring)

Assembly Instructions:

1. Ensure tube end is free from burrs and cut squarely.
2. Push the tube through the collet and into the fitting.
3. The tube needs to be pushed through the O-Ring until it bottoms out on the tube.
4. In order to strengthen the collet gripping, pull back on the tube.
5. In order to disconnect:
 - a. First check that there is not any residual air in the system.
 - b. Push the tube fitting until it bottoms out on the tube.
 - c. Hold down the collet and withdraw the tube.

AIR BRAKE NYLON TUBING
AIR BRAKE COPPER TUBING
AIR BRAKE SURELOK
COMPOSITE AIR BRAKE SURELOK
AIR BRAKE COMPRESSION FITTINGS
AIR BRAKE COUPLINGS FOR RUBBER HOSE
VALVES
BRASS LOCK-ON FIELD ATTACHABLE COUPLINGS
SINGLE BEAD
BARB STEM
INVERTED FLARE
AUTOMOTIVE ADAPTERS
COPPER TUBING INDUSTRIAL COMPRESSION
INDUSTRIAL SURELOK
MINI-BARBED TUBE
POLY INDUSTRIAL COMPRESSION
PIPE ADAPTERS
ADAPTERS SAE FLARE
THREADED SLEEVE
KITS & ASSORTMENTS

Industrial SureLok™ Plug



Part No.	Desc.	A1	Standard Pack
		"	
G56050-0004	4PLUG-SLI	1/4	5
G56050-0005	5PLUG-SLI	5/16	5
G56050-0006	6PLUG-SLI	3/8	1
G56050-0008	8PLUG-SLI	1/2	1
G56050-0010	10PLUG-SLI	5/8	1
G56050-0025	25PLUG-SLI	5/32	1

Industrial SureLok™ Cartridge

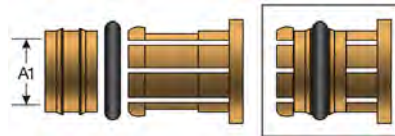

Part No.	Desc.	A1	Standard Pack
		"	
G56099-0002	2CARTRIDGE-SLI	1/8	5
G56099-0004	4CARTRIDGE-SLI	1/4	5
G56099-0005	5CARTRIDGE-SLI	5/16	5
G56099-0006	6CARTRIDGE-SLI	3/8	1
G56099-0008	8CARTRIDGE-SLI	1/2	1

Industrial SureLok™ to Male Pipe

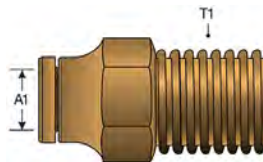



Part No.	Desc.	A1		Standard Pack
		"	T1 (in)	
G56100-0202	2SLI-2MP	1/8	1/8-27	1
G56100-0204	2SLI-4MP	1/8	1/4-18	1
G56100-0402	4SLI-2MP	1/4	1/8-27	1
G56100-0404	4SLI-4MP	1/4	1/4-18	1
G56100-0406	4SLI-6MP	1/4	3/8-18	1
G56100-0502	5SLI-2MP	5/16	1/8-27	1
G56100-0504	5SLI-4MP	5/16	1/4-18	1
G56100-0506	5SLI-6MP	5/16	3/8-18	1
G56100-0602	6SLI-2MP	3/8	1/8-27	1
G56100-0604	6SLI-4MP	3/8	1/4-18	1

Industrial SureLok™ to Male Pipe - Continued

Part No.	Desc.	A1		Standard Pack
		"	T1 (in)	
G56100-0606	6SLI-6MP	3/8	3/8-18	1
G56100-0608	6SLI-8MP	3/8	1/2-14	1
G56100-0806	8SLI-6MP	1/2	3/8-18	1
G56100-0808	8SLI-8MP	1/2	1/2-14	1
G56100-2502	25SLI-2MP	5/32	1/8-27	1
G56100-2504	25SLI-4MP	5/32	1/4-18	1

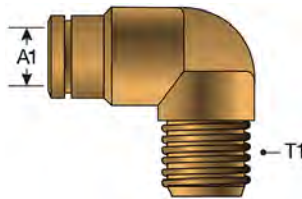
Industrial SureLok™ to Male Pipe - 90°



Part No.	Desc.	A1		Standard Pack
		"	T1 (in)	
G56104-0402	4SLI-2MP90	1/4	1/8-27	1
G56104-0404	4SLI-4MP90	1/4	1/4-18	1
G56104-0604	6SLI-4MP90	3/8	1/4-18	1
G56104-0606	6SLI-6MP90	3/8	3/8-18	1

Industrial SureLok™ to Male Pipe Swivel - 90°

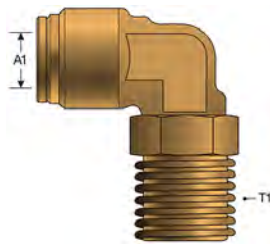

Part No.	Desc.	A1		Standard Pack
		"	T1 (in)	
G56124-0202	2SLI-2MPX90	1/8	1/8-27	1
G56124-0204	2SLI-4MPX90	1/8	1/4-18	1
G56124-0402	4SLI-2MPX90	1/4	1/8-27	1
G56124-0404	4SLI-4MPX90	1/4	1/4-18	1
G56124-0406	4SLI-6MPX90	1/4	3/8-18	1
G56124-0502	5SLI-2MPX90	5/16	1/8-27	1
G56124-0504	5SLI-4MPX90	5/16	1/4-18	1
G56124-0506	5SLI-6MPX90	5/16	3/8-18	1
G56124-0602	6SLI-2MPX90	3/8	1/8-27	1
G56124-0604	6SLI-4MPX90	3/8	1/4-18	1
G56124-0606	6SLI-6MPX90	3/8	3/8-18	1
G56124-0608	6SLI-8MPX90	3/8	1/2-14	1

- AIR BRAKE NYLON TUBING
- AIR BRAKE COPPER TUBING
- AIR BRAKE SURELOK
- COMPOSITE AIR BRAKE SURELOK
- AIR BRAKE COMPRESSION FITTINGS
- AIR BRAKE COUPLINGS FOR RUBBER HOSE
- VALVES
- BRASS LOCK-ON FIELD ATTACHABLE COUPLINGS
- SINGLE BEAD
- BARB STEM
- INVERTED FLARE
- AUTOMOTIVE ADAPTERS
- COPPER TUBING INDUSTRIAL COMPRESSION
- INDUSTRIAL SURELOK
- MINI-BARBED TUBE
- POLY INDUSTRIAL COMPRESSION
- PIPE ADAPTERS
- ADAPTERS SAE FLARE
- THREADED SLEEVE
- KITS & ASSORTMENTS

Industrial SureLok™ to Male Pipe Swivel - 90° - Continued

Part No.	Desc.	A1		Standard Pack
		"	T1 (in)	
G56124-0804	8SLI-4MPX90	1/2	1/4-18	1
G56124-0806	8SLI-6MPX90	1/2	3/8-18	1
G56124-0808	8SLI-8MPX90	1/2	1/2-14	1
G56124-2502	2.5SLI-2MPX90	5/32	1/8-27	1

Industrial SureLok™ Run Tee to Male Pipe Swivel

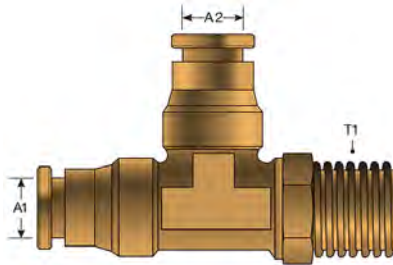

Part No.	Desc.	A1	A2		Standard Pack
		"	"	T1 (in)	
G56140-0402	4MPX-2SLI-2SLI	1/8	1/8	1/4-18	1
G56140-0404	4MPX-4SLI-4SLI	1/4	1/4	1/4-18	1
G56140-0604	6MPX-4SLI-4SLI	1/4	1/4	3/8-18	1
G56140-0606	6MPX-6SLI-6SLI	3/8	3/8	3/8-18	1
G56140-0806	8MPX-6SLI-6SLI	3/8	3/8	1/2-14	1
G56140-0808	8MPX-8SLI-8SLI	1/2	1/2	1/2-14	1

Industrial SureLok™ Branch Tee to Male Pipe Swivel

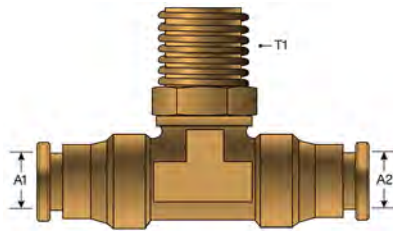

Part No.	Desc.	A1	A2		Standard Pack
		"	"	T1 (in)	
G56142-0202	2SLI-2SLI-2MPX	1/8	1/8	1/8-27	1
G56142-0402	4SLI-4SLI-2MPX	1/4	1/4	1/8-27	1
G56142-0404	4SLI-4SLI-4MPX	1/4	1/4	1/4-18	1
G56142-0604	6SLI-6SLI-4MPX	3/8	3/8	1/4-18	1
G56142-0606	6SLI-6SLI-6MPX	3/8	3/8	3/8-18	1
G56142-0608	6SLI-6SLI-8MPX	3/8	3/8	1/2-14	1
G56142-0804	8SLI-8SLI-4MPX	1/2	1/2	1/4-18	1
G56142-0806	8SLI-8SLI-6MPX	1/2	1/2	3/8-18	1
G56142-0808	8SLI-8SLI-8MPX	1/2	1/2	1/2-14	1
G56142-2502	25SLI-25SLI-2MPX	5/32	5/32	1/8-27	1

Industrial SureLok™ to Female Pipe



Part No.	Desc.	A1		Standard Pack
		"	T1 (in)	
G56150-0202	2SLI-2FP	1/8	1/8-27	1
G56150-0204	2SLI-4FP	1/8	1/4-18	1
G56150-0402	4SLI-2FP	1/4	1/8-27	1
G56150-0404	4SLI-4FP	1/4	1/4-18	1
G56150-0604	6SLI-4FP	3/8	1/4-18	1
G56150-0606	6SLI-6FP	3/8	3/8-18	1

Industrial SureLok™ Bulkhead Union



Part No.	Desc.	A1	A2	Standard Pack
		"	"	
G56300-0202	2SLI-2SLI-BKHD	1/8	1/8	1
G56300-0404	4SLI-4SLI-BKHD	1/4	1/4	1
G56300-0606	6SLI-6SLI-BKHD	3/8	3/8	1
G56300-0808	8SLI-8SLI-BKHD	1/2	1/2	1

Industrial SureLok™ Union



Part No.	Desc.	A1	A2	Standard Pack
		"	"	
G56400-0202	2SLI-2SLI	1/8	1/8	1
G56400-0204	2SLI-4SLI	1/8	1/4	1
G56400-0404	4SLI-4SLI	1/4	1/4	1
G56400-0406	4SLI-6SLI	1/4	3/8	1
G56400-0505	5SLI-5SLI	5/16	5/16	1
G56400-0606	6SLI-6SLI	3/8	3/8	1
G56400-0608	6SLI-8SLI	3/8	1/2	1
G56400-0808	8SLI-8SLI	1/2	1/2	1
G56400-1010	10SLI-10SLI	5/8	5/8	1
G56400-1212	12SLI-12SLI	3/4	3/4	1
G56400-2504	25SLI-4SLI	5/32	1/4	1
G56400-2525	25SLI-25SLI	5/32	5/32	1

AIR BRAKE
NYLON TUBING

AIR BRAKE
COPPER TUBING

AIR BRAKE
SURELOK

COMPOSITE AIR
BRAKE SURELOK

AIR BRAKE
COMPRESSION
FITTINGS

AIR BRAKE
COUPLINGS FOR
RUBBER HOSE

VALVES

BRASS LOCK-ON
FIELD
ATTACHABLE
COUPLINGS

SINGLE BEAD

BARB STEM

INVERTED FLARE

AUTOMOTIVE
ADAPTERS

COPPER TUBING
INDUSTRIAL
COMPRESSION

INDUSTRIAL
SURELOK

MINI-BARBED
TUBE

POLY
INDUSTRIAL
COMPRESSION

PIPE ADAPTERS

ADAPTERS SAE
FLARE

THREADED
SLEEVE

KITS &
ASSORTMENTS

Industrial SureLok™ Double Union



Part No.	Desc.	A1	A2	Standard Pack
		"	"	
G56402-0202	2SLI-2SLI-D	1/8	1/8	1
G56402-0404	4SLI-4SLI-D	1/4	1/4	1
G56402-0505	5SLI-5SLI-D	5/16	5/16	1
G56402-0606	6SLI-6SLI-D	3/8	3/8	1
G56402-0808	8SLI-8SLI-D	1/2	1/2	1
G56402-2525	25SLI-25SLI-D	5/32	5/32	1

Industrial SureLok™ Union - 90°

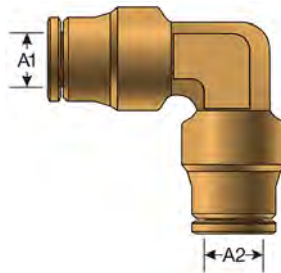

Part No.	Desc.	A1	A2	Standard Pack
		"	"	
G56404-0202	2SLI-2SLI90	1/8	1/8	1
G56404-0404	4SLI-4SLI90	1/4	1/4	1
G56404-0505	5SLI-5SLI90	5/16	5/16	1
G56404-0606	6SLI-6SLI90	3/8	3/8	1
G56404-0808	8SLI-8SLI90	1/2	1/2	1
G56404-2525	25SLI-25SLI90	5/32	5/32	1

Industrial SureLok™ Union - Tee

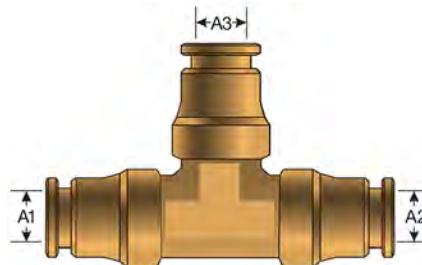

Part No.	Desc.	A1	A2	A3	Standard Pack
		"	"	"	
G56450-0202	2SLI-2SLI-2SLI	1/8	1/8	1/8	1
G56450-0404	4SLI-4SLI-4SLI	1/4	1/4	1/4	1

Industrial SureLok™ Union - Tee - Continued

Part No.	Desc.	A1	A2	A3	Standard Pack
		"	"	"	
G56450-0505	5SLI-5SLI-5SLI	5/16	5/16	5/16	1
G56450-0606	6SLI-6SLI-6SLI	3/8	3/8	3/8	1
G56450-0808	8SLI-8SLI-8SLI	1/2	1/2	1/2	1
G56450-1212	12SLI-12SLI-12SLI	3/4	3/4	3/4	1
G56450-2525	25SLI-25SLI-25SLI	5/32	5/32	5/32	1

- AIR BRAKE
NYLON TUBING
- AIR BRAKE
COPPER TUBING
- AIR BRAKE
SURELOK
- COMPOSITE AIR
BRAKE SURELOK
- AIR BRAKE
COMPRESSION
FITTINGS
- AIR BRAKE
COUPLINGS FOR
RUBBER HOSE
- VALVES
- BRASS LOCK-ON
FIELD
ATTACHABLE
COUPLINGS
- SINGLE BEAD
- BARB STEM
- INVERTED FLARE
- AUTOMOTIVE
ADAPTERS
- COPPER TUBING
INDUSTRIAL
COMPRESSION
- INDUSTRIAL
SURELOK
- MINI-BARBED
TUBE
- POLY
INDUSTRIAL
COMPRESSION
- PIPE ADAPTERS
- ADAPTERS SAE
FLARE
- THREADED
SLEEVE
- KITS &
ASSORTMENTS

AIR BRAKE NYLON TUBING
AIR BRAKE COPPER TUBING
AIR BRAKE SURELOK
COMPOSITE AIR BRAKE SURELOK
AIR BRAKE COMPRESSION FITTINGS
AIR BRAKE COUPLINGS FOR RUBBER HOSE
VALVES
BRASS LOCK-ON FIELD ATTACHABLE COUPLINGS
SINGLE BEAD
BARB STEM
INVERTED FLARE
AUTOMOTIVE ADAPTERS
COPPER TUBING INDUSTRIAL COMPRESSION
INDUSTRIAL SURELOK
MINI-BARBED TUBE
POLY INDUSTRIAL COMPRESSION
PIPE ADAPTERS
ADAPTERS SAE FLARE
THREADED SLEEVE
KITS & ASSORTMENTS

Recommended For: Pneumatic applications, lubrication and cooling lines, vacuum and fluid systems.

Used With: Polyethylene tubing

Features and Benefits: Allows for quick connection without any tube preparation. Barbed design provides a safe connection and a positive, tactile feel when the connection is made.

Conformance: Works with barbed tube designs such as SAE J1231.

Working Pressure: Dependent on the burst pressure of the polyethylene tubing.

Temperature Range: -65°F to +250°F (-53° to +121°C)

Material: 360 Brass

Assembly Instructions:

1. Ensure there are not any burrs on the tubing and the end is cut square.
2. Push the tubing over the insert until the tubing bottoms out on the connector body.

Plug

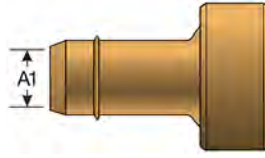

Part No.	Desc.	A1	Standard Pack
		"	
G57050-0004	4PLUG-MBT	1/4	5
G57050-0006	6PLUG-MBT	3/8	1
G57050-0008	8PLUG-MBT	1/2	1

Mini-Barb to Male Pipe

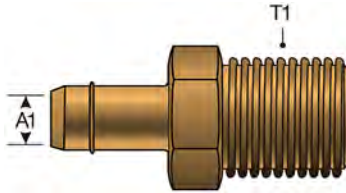

Part No.	Desc.	A1		Standard Pack
		"	T1 (in)	
G57100-0401	4MBT-1MP	1/4	1/16-32	1
G57100-0402	4MBT-2MP	1/4	1/8-27	1
G57100-0404	4MBT-4MP	1/4	1/4-18	1
G57100-0602	6MBT-2MP	3/8	1/8-27	1
G57100-0604	6MBT-4MP	3/8	1/4-18	1
G57100-0608	6MBT-8MP	3/8	1/2-14	1
G57100-0806	8MBT-6MP	1/2	3/8-18	1
G57100-2502	25MBT-2MP	5/32	1/8-27	1

Mini-Barb to Male Pipe - 90°

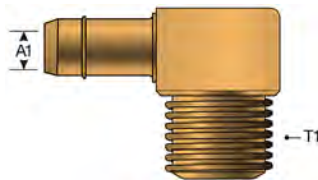

Part No.	Desc.	A1		Standard Pack
		"	T1 (in)	
G57104-0401	4MBT-1MP90	1/4	1/16-32	1
G57104-0402	4MBT-2MP90	1/4	1/8-27	1
G57104-0404	4MBT-4MP90	1/4	1/4-18	1
G57104-0602	6MBT-2MP90	3/8	1/8-27	1
G57104-0604	6MBT-4MP90	3/8	1/4-18	1
G57104-0806	8MBT-6MP90	1/2	3/8-18	1

- AIR BRAKE NYLON TUBING
- AIR BRAKE COPPER TUBING
- AIR BRAKE SURELOK
- COMPOSITE AIR BRAKE SURELOK
- AIR BRAKE COMPRESSION FITTINGS
- AIR BRAKE COUPLINGS FOR RUBBER HOSE
- VALVES
- BRASS LOCK-ON FIELD ATTACHABLE COUPLINGS
- SINGLE BEAD
- BARB STEM
- INVERTED FLARE
- AUTOMOTIVE ADAPTERS
- COPPER TUBING INDUSTRIAL COMPRESSION
- INDUSTRIAL SURELOK
- MINI-BARBED TUBE
- POLY INDUSTRIAL COMPRESSION
- PIPE ADAPTERS
- ADAPTERS SAE FLARE
- THREADED SLEEVE
- KITS & ASSORTMENTS

Mini-Barb Run Tee to Male Pipe

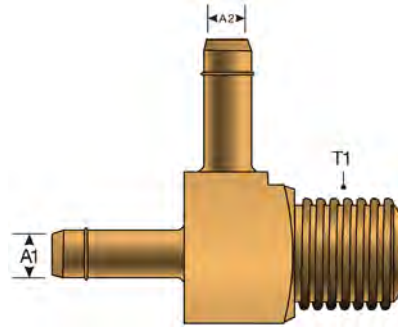

Part No.	Desc.	A1	A2		Standard Pack
		"	"	T1 (in)	
G57130-0204	2MP-4MBT-4MBT	1/4	1/4	1/8-27	1
G57130-0206	2MP-6MBT-6MBT	3/8	3/8	1/8-27	1
G57130-0402	4MP-2MBT-2MBT	1/8	1/8	1/8-27	1
G57130-0602	6MP-2MBT-2MBT	1/8	1/8	1/8-27	1
G57130-0604	6MP-4MBT-4MBT	1/4	1/4	3/8-18	1

Mini-Barb to Female Pipe

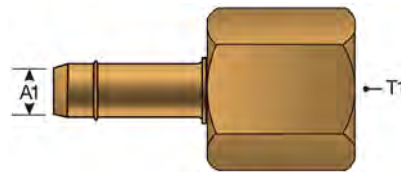

Part No.	Desc.	A1		Standard Pack
		"	T1 (in)	
G57150-0402	4MBT-2FP	1/4	1/8-27	1
G57150-0404	4MBT-4FP	1/4	1/4-18	1

Mini-Barb to Female Pipe - 90°

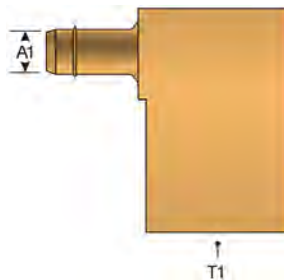

Part No.	Desc.	A1		Standard Pack
		"	T1 (in)	
G57154-0402	4MBT-2FP90	1/4	1/8-27	1
G57154-0604	6MBT-4FP90	3/8	1/4-18	1

Mini-Barb Branch Tee to Female Pipe

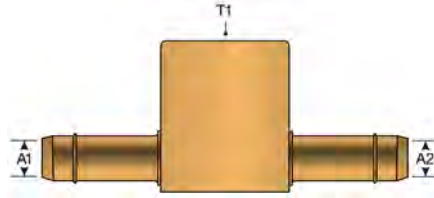

Part No.	Desc.	A1	A2		Standard Pack
		"	"	T1 (in)	
G57160-0402	4MBT-4MBT-2FP	1/4	1/4	1/8-27	1

Mini-Barb to Industrial Copper Tubing Compression



Part No.	Desc.	A1	Standard Pack
		"	
G57190-0304	3MBT-4MFA	3/16	1
G57190-0404	4MBT-4MFA	1/4	1

Mini-Barb Bulkhead Union



Part No.	Desc.	A1	A2	Standard Pack
		"	"	
G57300-0404	4MBT-4MBT-BKHD	1/4	1/4	1
G57300-0606	6MBT-6MBT-BKHD	3/8	3/8	1
G57300-0808	8MBT-8MBT-BKHD	1/2	1/2	1

Mini-Barb to Copper Tubing Industrial Compression Assembly Bulkhead



Part No.	Desc.	A1	Standard Pack
		"	
G57350-0404	4MBT-4MFA-BKHD	1/4	1

- AIR BRAKE NYLON TUBING
- AIR BRAKE COPPER TUBING
- AIR BRAKE SURELOK
- COMPOSITE AIR BRAKE SURELOK
- AIR BRAKE COMPRESSION FITTINGS
- AIR BRAKE COUPLINGS FOR RUBBER HOSE
- VALVES
- BRASS LOCK-ON FIELD ATTACHABLE COUPLINGS
- SINGLE BEAD
- BARB STEM
- INVERTED FLARE
- AUTOMOTIVE ADAPTERS
- COPPER TUBING INDUSTRIAL COMPRESSION
- INDUSTRIAL SURELOK
- MINI-BARBED TUBE
- POLY INDUSTRIAL COMPRESSION
- PIPE ADAPTERS
- ADAPTERS SAE FLARE
- THREADED SLEEVE
- KITS & ASSORTMENTS

Mini-Barb to Copper Tubing Industrial Compression Assembly Bulkhead - Continued

Part No.	Desc.	A1	Standard Pack
		"	
G57350-0606	6MBT-6MFA-BKHD	3/8	1

Mini-Barb Union



Part No.	Desc.	A1	A2	Standard Pack
		"	"	
G57400-0304	3MBT-4MBT	3/16	1/4	1
G57400-0404	4MBT-4MBT	1/4	1/4	1
G57400-0406	4MBT-6MBT	1/4	3/8	1
G57400-0606	6MBT-6MBT	3/8	3/8	1
G57400-0804	8MBT-4MBT	1/2	1/4	1
G57400-0806	8MBT-6MBT	1/2	3/8	1
G57400-0808	8MBT-8MBT	1/2	1/2	1

Mini-Barb Union - Long

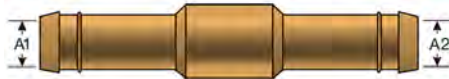

Part No.	Desc.	A1	A2	Standard Pack
		"	"	
G57401-0404	4MBT-4MBTL	1/4	1/4	1

Mini-Barb Union - 90°

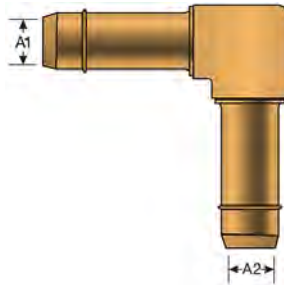

Part No.	Desc.	A1	A2	Standard Pack
		"	"	
G57404-0404	4MBT-4MBT90	1/4	1/4	1
G57404-0606	6MBT-6MBT90	3/8	3/8	1
G57404-0808	8MBT-8MBT90	1/2	1/2	1

Mini-Barb Union - Tee

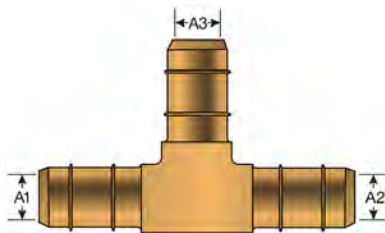

Part No.	Desc.	A1	A2	A3	Standard Pack
		"	"	"	
G57452-0404	4MBT-4MBT-4MBT	1/4	1/4	1/4	1
G57452-0604	6MBT-4MBT-4MBT	3/8	1/4	1/4	1
G57452-0606	6MBT-6MBT-6MBT	3/8	3/8	3/8	1
G57452-0608	6MBT-8MBT-6MBT	3/8	1/2	3/8	1
G57452-0804	8MBT-8MBT-4MBT	1/2	1/2	1/4	1
G57452-0806	8MBT-8MBT-6MBT	1/2	1/2	3/8	1
G57452-0808	8MBT-8MBT-8MBT	1/2	1/2	1/2	1

AIR BRAKE
NYLON TUBING

AIR BRAKE
COPPER TUBING

AIR BRAKE
SURELOK

COMPOSITE AIR
BRAKE SURELOK

AIR BRAKE
COMPRESSION
FITTINGS

AIR BRAKE
COUPLINGS FOR
RUBBER HOSE

VALVES

BRASS LOCK-ON
FIELD
ATTACHABLE
COUPLINGS

SINGLE BEAD

BARB STEM

INVERTED FLARE

AUTOMOTIVE
ADAPTERS

COPPER TUBING
INDUSTRIAL
COMPRESSION

INDUSTRIAL
SURELOK

MINI-BARBED
TUBE

POLY
INDUSTRIAL
COMPRESSION

PIPE ADAPTERS

ADAPTERS SAE
FLARE

THREADED
SLEEVE

KITS &
ASSORTMENTS

- AIR BRAKE NYLON TUBING
- AIR BRAKE COPPER TUBING
- AIR BRAKE SURELOK
- COMPOSITE AIR BRAKE SURELOK
- AIR BRAKE COMPRESSION FITTINGS
- AIR BRAKE COUPLINGS FOR RUBBER HOSE
- VALVES
- BRASS LOCK-ON FIELD ATTACHABLE COUPLINGS
- SINGLE BEAD
- BARB STEM
- INVERTED FLARE
- AUTOMOTIVE ADAPTERS
- COPPER TUBING INDUSTRIAL COMPRESSION
- INDUSTRIAL SURELOK
- MINI-BARBED TUBE
- POLY INDUSTRIAL COMPRESSION
- PIPE ADAPTERS
- ADAPTERS SAE FLARE
- THREADED SLEEVE
- KITS & ASSORTMENTS

Tube O.D. (in)	1/4	5/16	3/8	1/2
Thread Size	3/8-24	7/16-24	1/2-24	11/16-20

Recommended For: Hydraulic and pneumatic systems.

Used With: Polyvinylchloride and polyethylene tubing

Features and Benefits: Easy installation without any required tube flaring.

Conformance: Exclusive product design not requiring flaring.

Working Pressure: 200 psi (14 bar)

Temperature Range: -65°F to +250°F (-53° to +121°C)

Material: 360 Brass with plastic sleeve

Assembly Instructions:

1. Measure the tube and cut to the desired length. Ensure the tube is free from burrs and cut square.
2. Slide the nut and tube onto the sleeve.
3. Insert the tube and ensure it bottoms out on the seat of the fitting.
4. Hand tighten the fitting and place one mark on the nut.
5. Tighten with a wrench using the number of turns shown on the chart below.

Tube Size	Turns from Hand Tight
3/16	1-1/3
1/4	1-2/3
5/16	2-2/3
3/8	2

Tubing Sleeve

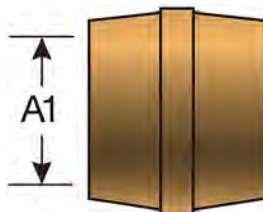

Part No.	Desc.	A1	Standard Pack
		"	
G58050-0002	2TSI-PVC	1/8	5
G58050-0003	3TSI-PVC	3/16	5
G58050-0004	4TSI-PVC	1/4	5
G58050-0005	5TSI-PVC	5/16	1
G58050-0006	6TSI-PVC	3/8	1
G58050-0008	8TSI-PVC	1/2	1
G58050-0010	10TSI-PVC	5/8	1
G58050-0012	12TSI-PVC	3/4	1
G58050-0016	16TSI-PVC	1	1

Tubing Sleeve Nut

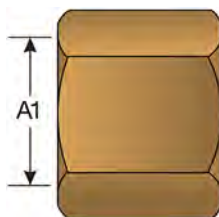

Part No.	Desc.	A1	Standard Pack
		"	
G58060-0002	2TSN-PVC	1/8	5
G58060-0003	3TSN-PVC	3/16	5
G58060-0004	4TSN-PVC	1/4	5
G58060-0005	5TSN-PVC	5/16	1
G58060-0006	6TSN-PVC	3/8	1
G58060-0008	8TSN-PVC	1/2	1
G58060-0010	10TSN-PVC	5/8	1

AIR BRAKE
NYLON TUBING

AIR BRAKE
COPPER TUBING

AIR BRAKE
SURELOK

COMPOSITE AIR
BRAKE SURELOK

AIR BRAKE
COMPRESSION
FITTINGS

AIR BRAKE
COUPLINGS FOR
RUBBER HOSE

VALVES

BRASS LOCK-ON
FIELD
ATTACHABLE
COUPLINGS

SINGLE BEAD

BARB STEM

INVERTED FLARE

AUTOMOTIVE
ADAPTERS

COPPER TUBING
INDUSTRIAL
COMPRESSION

INDUSTRIAL
SURELOK

MINI-BARBED
TUBE

POLY
INDUSTRIAL
COMPRESSION

PIPE ADAPTERS

ADAPTERS SAE
FLARE

THREADED
SLEEVE

KITS &
ASSORTMENTS

Compression PVC to Male Pipe

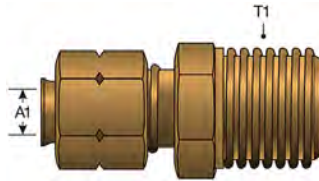

Part No.	Desc.	A1		Standard Pack
		"	T1 (in)	
G58100-0201	2PVC-1MP	1/8	1/16-32	1
G58100-0202	2PVC-2MP	1/8	1/8-27	1
G58100-0302	3PVC-2MP	3/16	1/8-27	1
G58100-0304	3PVC-4MP	3/16	1/4-18	1
G58100-0402	4PVC-2MP	1/4	1/8-27	1
G58100-0404	4PVC-4MP	1/4	1/4-18	1
G58100-0502	5PVC-2MP	5/16	1/8-27	1
G58100-0504	5PVC-4MP	5/16	1/4-18	1
G58100-0604	6PVC-4MP	3/8	1/4-18	1
G58100-0606	6PVC-6MP	3/8	3/8-18	1
G58100-0608	6PVC-8MP	3/8	1/2-14	1
G58100-1212	12PVC-12MP	3/4	3/4-14	1

Compression PVC to Male Pipe - 90°

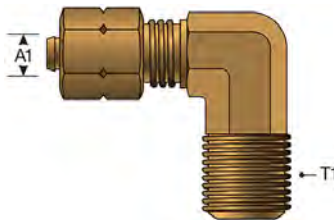

Part No.	Desc.	A1		Standard Pack
		"	T1 (in)	
G58104-0201	2PVC-1MP90	1/8	1/16-32	1
G58104-0202	2PVC-2MP90	1/8	1/8-27	1
G58104-0302	3PVC-2MP90	3/16	1/8-27	1
G58104-0402	4PVC-2MP90	1/4	1/8-27	1
G58104-0404	4PVC-4MP90	1/4	1/4-18	1
G58104-0604	6PVC-4MP90	3/8	1/4-18	1
G58104-0606	6PVC-6MP90	3/8	3/8-18	1
G58104-0608	6PVC-8MP90	3/8	1/2-14	1
G58104-0808	8PVC-8MP90	1/2	1/2-14	1
G58104-1008	10PVC-8MP90	5/8	1/2-14	1

Compression PVC Branch Tee to Male Pipe

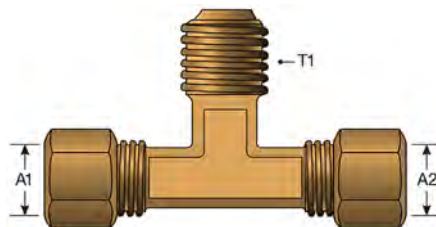

Part No.	Desc.	A1	A2		Standard Pack
		"	"	T1 (in)	
G58134-0402	4PVC-4PVC-2MP	1/4	1/4	1/8-27	1
G58134-0604	6PVC-6PVC-4MP	3/8	3/8	1/4-18	1
G58134-0806	8PVC-8PVC-6MP	1/2	1/2	3/8-18	1

Compression PVC to Female Pipe

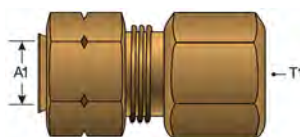

Part No.	Desc.	A1		Standard Pack
		"	T1 (in)	
G58150-0202	2PVC-2FP	1/8	1/8-27	1
G58150-0402	4PVC-2FP	1/4	1/8-27	1
G58150-0604	6PVC-4FP	3/8	1/4-18	1

Compression PVC Union



Part No.	Desc.	A1	A2	Standard Pack
		"	"	
G58400-0202	2PVC-2PVC	1/8	1/8	1
G58400-0303	3PVC-3PVC	3/16	3/16	1
G58400-0404	4PVC-4PVC	1/4	1/4	1
G58400-0505	5PVC-5PVC	5/16	5/16	1
G58400-0606	6PVC-6PVC	3/8	3/8	1
G58400-0808	8PVC-8PVC	1/2	1/2	1
G58400-1010	10PVC-10PVC	5/8	5/8	1

AIR BRAKE
NYLON TUBING

AIR BRAKE
COPPER TUBING

AIR BRAKE
SURELOK

COMPOSITE AIR
BRAKE SURELOK

AIR BRAKE
COMPRESSION
FITTINGS

AIR BRAKE
COUPLINGS FOR
RUBBER HOSE

VALVES

BRASS LOCK-ON
FIELD
ATTACHABLE
COUPLINGS

SINGLE BEAD

BARB STEM

INVERTED FLARE

AUTOMOTIVE
ADAPTERS

COPPER TUBING
INDUSTRIAL
COMPRESSION

INDUSTRIAL
SURELOK

MINI-BARBED
TUBE

POLY
INDUSTRIAL
COMPRESSION

PIPE ADAPTERS

ADAPTERS SAE
FLARE

THREADED
SLEEVE

KITS &
ASSORTMENTS

AIR BRAKE NYLON TUBING
AIR BRAKE COPPER TUBING
AIR BRAKE SURELOK
COMPOSITE AIR BRAKE SURELOK
AIR BRAKE COMPRESSION FITTINGS
AIR BRAKE COUPLINGS FOR RUBBER HOSE
VALVES
BRASS LOCK-ON FIELD ATTACHABLE COUPLINGS
SINGLE BEAD
BARB STEM
INVERTED FLARE
AUTOMOTIVE ADAPTERS
COPPER TUBING INDUSTRIAL COMPRESSION
INDUSTRIAL SURELOK
MINI-BARBED TUBE
POLY INDUSTRIAL COMPRESSION
PIPE ADAPTERS
ADAPTERS SAE FLARE
THREADED SLEEVE
KITS & ASSORTMENTS

Pipe Size	1/16	1/8	1/4	3/8	1/2	3/4
Thread Size	1/16-27	1/8-27	1/4-18	3/8-18	1/2-14	3/4-14

Recommended For: Grease, refrigeration, and instrumentation.

Used With: Brass and steel tubing

Features and Benefits: A large range of sizes and configurations which covers most application needs.

Conformance: ASME, SAE

Working Pressure: 1,200 psi (82 bar)

Temperature Range: -65°F to +250°F (-53° to +121°C)

Material: 360 Brass

Assembly Instructions:

1. Align the threads and tighten 2-1/2 turns past hand tight.
2. If the connector states "Seal-A-Thread", only tighten 2 turns past hand tight.

Female Pipe to Female Pipe Bulkhead

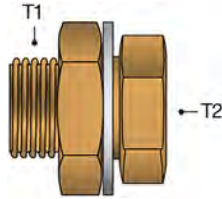

Part No.	Desc.	🌀		Standard Pack
		T1 (in)	T2 (in)	
G33300-0202	2FP-2FPBKHD	1/8-27	1/8-27	1
G33300-0404	4FP-4FPBKHD	1/4-18	1/4-18	1
G33300-0606	6FP-6FPBKHD	3/8-18	3/8-18	1
G33300-0804	8FP-4FPBKHD	1/2-14	1/4-18	1
G33300-0808	8FP-8FPBKHD	1/2-14	1/2-14	1
G33301-0404	4FP-4FPBKHDS	1/4-18	1/4-18	1
G33301-0804	8FP-4FPBKHDS	1/2-14	1/4-18	1

Male Pipe to Female Pipe Bulkhead

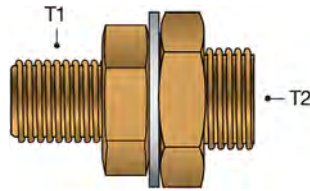

Part No.	Desc.	🌀		Standard Pack
		T1 (in)	T2 (in)	
G33302-0804	8MP-4FPBKHDL	1/2-14	1/4-18	1
G33303-0806	8MP-6FPBKHD	1/2-14	3/8-18	1

Female Pipe Cap

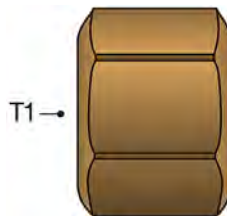



Part No.	Desc.	🌀	Standard Pack
		T1 (in)	
G60600-0002	2FPB-CAP	1/8-27	1
G60600-0004	4FPB-CAP	1/4-18	1
G60600-0006	6FPB-CAP	3/8-18	1
G60600-0008	8FPB-CAP	1/2-14	1
G60600-0012	12FPB-CAP	3/4-14	1

- AIR BRAKE NYLON TUBING
- AIR BRAKE COPPER TUBING
- AIR BRAKE SURELOK
- COMPOSITE AIR BRAKE SURELOK
- AIR BRAKE COMPRESSION FITTINGS
- AIR BRAKE COUPLINGS FOR RUBBER HOSE
- VALVES
- BRASS LOCK-ON FIELD ATTACHABLE COUPLINGS
- SINGLE BEAD
- BARB STEM
- INVERTED FLARE
- AUTOMOTIVE ADAPTERS
- COPPER TUBING INDUSTRIAL COMPRESSION
- INDUSTRIAL SURELOK
- MINI-BARBED TUBE
- POLY INDUSTRIAL COMPRESSION
- PIPE ADAPTERS
- ADAPTERS SAE FLARE
- THREADED SLEEVE
- KITS & ASSORTMENTS

AIR BRAKE NYLON TUBING
AIR BRAKE COPPER TUBING
AIR BRAKE SURELOK
COMPOSITE AIR BRAKE SURELOK
AIR BRAKE COMPRESSION FITTINGS
AIR BRAKE COUPLINGS FOR RUBBER HOSE
VALVES
BRASS LOCK-ON FIELD ATTACHABLE COUPLINGS
SINGLE BEAD
BARB STEM
INVERTED FLARE
AUTOMOTIVE ADAPTERS
COPPER TUBING INDUSTRIAL COMPRESSION
INDUSTRIAL SURELOK
MINI-BARBED TUBE
POLY INDUSTRIAL COMPRESSION
PIPE ADAPTERS
ADAPTERS SAE FLARE
THREADED SLEEVE
KITS & ASSORTMENTS

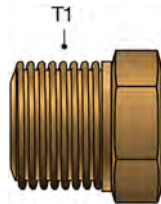
Male Pipe Plug - Hex Head



Part No.	Desc.		Standard Pack
		T1 (in)	
G60601-0001	1MPB-PLUG	1/16-32	5
G60601-0002	2MPB-PLUG	1/8-27	5
G60601-0004	4MPB-PLUG	1/4-18	1
G60601-0006	6MPB-PLUG	3/8-18	1
G60601-0008	8MPB-PLUG	1/2-14	1
G60601-0012	12MPB-PLUG	3/4-14	1

Male Pipe Plug - Square Head

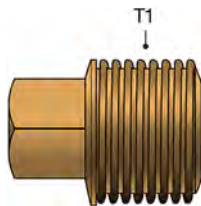

Part No.	Desc.		Standard Pack
		T1 (in)	
G60602-0002	2MPB-PLUG SQ HEAD	1/8-27	5
G60602-0004	4MPB-PLUG SQ HEAD	1/4-18	5
G60602-0006	6MPB-PLUG SQ HEAD	3/8-18	1
G60602-0008	8MPB-PLUG SQ HEAD	1/2-14	1
G60602-0012	12MPB-PLUG SQ HEAD	3/4-14	1

Male Pipe Plug - Hex Key Head

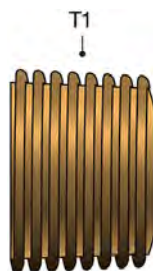

Part No.	Desc.		Standard Pack
		T1 (in)	
G60603-0001	1MPB-PLUG HK HEAD	1/16-32	5
G60603-0002	2MPB-PLUG HK HEAD	1/8-27	5

Male Pipe Plug - Hex Key Head - Continued

Part No.	Desc.			Standard Pack
		T1 (in)		
G60603-0004	4MPB-PLUG HK HEAD	1/4-18		1
G60603-0006	6MPB-PLUG HK HEAD	3/8-18		1
G60603-0008	8MPB-PLUG HK HEAD	1/2-14		1

Male Pipe Plug - Slotted Head



Part No.	Desc.			Standard Pack
		T1 (in)		
G60604-0002	2MPB-PLUG-SL	1/8-27		5
G60604-0004	4MPB-PLUG-SL	1/4-18		5
G60604-0006	6MPB-PLUG-SL	3/8-18		1

Male Pipe to Male Pipe Hex Nipple

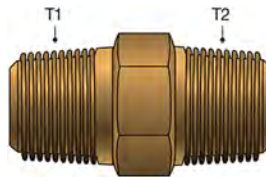



Part No.	Desc.			Standard Pack
		T1 (in)	T2 (in)	
G60605-0101	1MP-1MP	1/16-32	1/16-32	1
G60605-0102	1MP-2MPB	1/16-32	1/8-27	1
G60605-0202	2MP-2MPB	1/8-27	1/8-27	1
G60605-0204	2MP-4MPB	1/8-27	1/4-18	1
G60605-0206	2MP-6MPB	1/8-27	3/8-18	1
G60605-0404	4MP-4MPB	1/4-18	1/4-18	1
G60605-0406	4MP-6MPB	1/4-18	3/8-18	1
G60605-0408	4MP-8MPB	1/4-18	1/2-14	1
G60605-0606	6MP-6MPB	3/8-18	3/8-18	1
G60605-0608	6MP-8MPB	3/8-18	1/2-14	1
G60605-0808	8MP-8MPB	1/2-14	1/2-14	1
G60605-0812	8MP-12MPB	1/2-14	3/4-14	1
G60605-1212	12MP-12MPB	3/4-14	3/4-14	1

- AIR BRAKE NYLON TUBING
- AIR BRAKE COPPER TUBING
- AIR BRAKE SURELOK
- COMPOSITE AIR BRAKE SURELOK
- AIR BRAKE COMPRESSION FITTINGS
- AIR BRAKE COUPLINGS FOR RUBBER HOSE
- VALVES
- BRASS LOCK-ON FIELD ATTACHABLE COUPLINGS
- SINGLE BEAD
- BARB STEM
- INVERTED FLARE
- AUTOMOTIVE ADAPTERS
- COPPER TUBING INDUSTRIAL COMPRESSION
- INDUSTRIAL SURELOK
- MINI-BARBED TUBE
- POLY INDUSTRIAL COMPRESSION
- PIPE ADAPTERS**
- ADAPTERS SAE FLARE
- THREADED SLEEVE
- KITS & ASSORTMENTS

AIR BRAKE NYLON TUBING
AIR BRAKE COPPER TUBING
AIR BRAKE SURELOK
COMPOSITE AIR BRAKE SURELOK
AIR BRAKE COMPRESSION FITTINGS
AIR BRAKE COUPLINGS FOR RUBBER HOSE
VALVES
BRASS LOCK-ON FIELD ATTACHABLE COUPLINGS
SINGLE BEAD
BARB STEM
INVERTED FLARE
AUTOMOTIVE ADAPTERS
COPPER TUBING INDUSTRIAL COMPRESSION
INDUSTRIAL SURELOK
MINI-BARBED TUBE
POLY INDUSTRIAL COMPRESSION
PIPE ADAPTERS
ADAPTERS SAE FLARE
THREADED SLEEVE
KITS & ASSORTMENTS

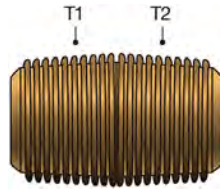
Male Pipe to Male Pipe Close Nipple



Part No.	Desc.			Standard Pack
		T1 (in)	T2 (in)	
G60606-0202	2MP-2MPB-CNS	1/8-27	1/8-27	1
G60606-0404	4MP-4MPB-CNS	1/4-18	1/4-18	1
G60606-0606	6MP-6MPB-CNS	3/8-18	3/8-18	1
G60606-0808	8MP-8MPB-CNS	1/2-14	1/2-14	1
G60606-1212	12MP-12MPB-CNS	3/4-14	3/4-14	1

Male Pipe to Male Pipe Medium Nipple

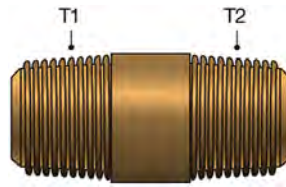

Part No.	Desc.			Standard Pack
		T1 (in)	T2 (in)	
G60607-0202	2MP-2MPB-CNL	1/8-27	1/8-27	1
G60607-0404	4MP-4MPB-CNL	1/4-18	1/4-18	1
G60607-0606	6MP-6MPB-CNL	3/8-18	3/8-18	1

Male Pipe to Male Pipe Long Nipple



Part No.	Desc.			Standard Pack
		T1 (in)	T2 (in)	
G60608-0202	2MP-2MPB-CNXL	1/8-27	1/8-27	1
G60608-0404	4MP-4MPB-CNXL	1/4-18	1/4-18	1
G60608-0606	6MP-6MPB-CNXL	3/8-18	3/8-18	1
G60608-0808	8MP-8MPB-CNXL	1/2-14	1/2-14	1
G60608-1212	12MP-12MPB-CNXL	3/4-14	3/4-14	1

Male Pipe NPTF to Male Pipe NPTF - 90°

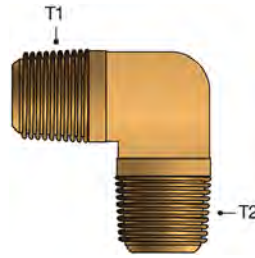

Part No.	Desc.			Standard Pack
		T1 (in)	T2 (in)	
G60610-0202	2MP-2MPB90	1/8-27	1/8-27	1
G60610-0204	2MP-4MPB90	1/8-27	1/4-18	1
G60610-0206	2MP-6MPB90	1/8-27	3/8-18	1
G60610-0404	4MP-4MPB90	1/4-18	1/4-18	1
G60610-0406	4MP-6MPB90	1/4-18	3/8-18	1
G60610-0606	6MP-6MPB90	3/8-18	3/8-18	1
G60610-0608	6MP-8MPB90	3/8-18	1/2-14	1
G60610-0808	8MP-8MPB90	1/2-14	1/2-14	1

Male Pipe NPTF Union - Tee

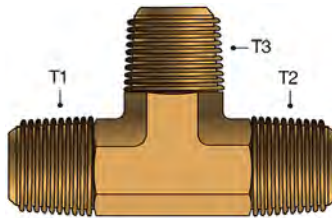

Part No.	Desc.				Standard Pack
		T1 (in)	T2 (in)	T3 (in)	
G60612-0202	2MP-2MP-2MPB	1/8-27	1/8-27	1/8-27	1
G60612-0404	4MP-4MP-4MPB	1/4-18	1/4-18	1/4-18	1
G60612-0606	6MP-6MP-6MPB	3/8-18	3/8-18	3/8-18	1
G60612-0808	8MP-8MP-8MPB	1/2-14	1/2-14	1/2-14	1
G60612-1212	12MP-12MP-12MPB	3/4-14	3/4-14	3/4-14	1

- AIR BRAKE NYLON TUBING
- AIR BRAKE COPPER TUBING
- AIR BRAKE SURELOK
- COMPOSITE AIR BRAKE SURELOK
- AIR BRAKE COMPRESSION FITTINGS
- AIR BRAKE COUPLINGS FOR RUBBER HOSE
- VALVES
- BRASS LOCK-ON FIELD ATTACHABLE COUPLINGS
- SINGLE BEAD
- BARB STEM
- INVERTED FLARE
- AUTOMOTIVE ADAPTERS
- COPPER TUBING INDUSTRIAL COMPRESSION
- INDUSTRIAL SURELOK
- MINI-BARBED TUBE
- POLY INDUSTRIAL COMPRESSION
- PIPE ADAPTERS
- ADAPTERS SAE FLARE
- THREADED SLEEVE
- KITS & ASSORTMENTS

Male Pipe to Female Pipe - Reducer

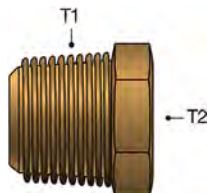

Part No.	Desc.			Standard Pack
		T1 (in)	T2 (in)	
G60614-0402	4MP-2FPB	1/4-18	1/8-27	1
G60614-0602	6MP-2FPB	3/8-18	1/8-27	1
G60614-0604	6MP-4FPB	3/8-18	1/4-18	1
G60614-0802	8MP-2FPB	1/2-14	1/8-27	1
G60614-0804	8MP-4FPB	1/2-14	1/4-18	1
G60614-0806	8MP-6FPB	1/2-14	3/8-18	1
G60614-1206	12MP-6FPB	3/4-14	3/8-18	1
G60614-1208	12MP-8FPB	3/4-14	1/2-14	1

Male Pipe to Female Pipe - Long

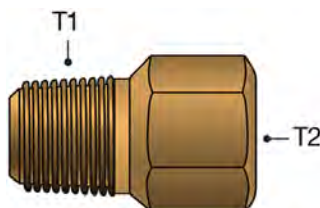

Part No.	Desc.			Standard Pack
		T1 (in)	T2 (in)	
G60615-0102	1MP-2FPB-L	1/16-32	1/8-27	1
G60615-0202	2MP-2FPB-L	1/8-27	1/8-27	1
G60615-0204	2MP-4FPB-L	1/8-27	1/4-18	1
G60615-0206	2MP-6FPB-L	1/8-27	3/8-18	1
G60615-0404	4MP-4FPB-L	1/4-18	1/4-18	1
G60615-0406	4MP-6FPB-L	1/4-18	3/8-18	1
G60615-0408	4MP-8FPB-L	1/4-18	1/2-14	1
G60615-0606	6MP-6FPB-L	3/8-18	3/8-18	1
G60615-0608	6MP-8FPB-L	3/8-18	1/2-14	1
G60615-0808	8MP-8FPB-L	1/2-14	1/2-14	1
G60615-0812	8MP-12FPB-L	1/2-14	3/4-14	1
G60615-1212	12MP-12FPB-L	3/4-14	3/4-14	1

- AIR BRAKE NYLON TUBING
- AIR BRAKE COPPER TUBING
- AIR BRAKE SURELOK
- COMPOSITE AIR BRAKE SURELOK
- AIR BRAKE COMPRESSION FITTINGS
- AIR BRAKE COUPLINGS FOR RUBBER HOSE
- VALVES
- BRASS LOCK-ON FIELD ATTACHABLE COUPLINGS
- SINGLE BEAD
- BARB STEM
- INVERTED FLARE
- AUTOMOTIVE ADAPTERS
- COPPER TUBING INDUSTRIAL COMPRESSION
- INDUSTRIAL SURELOK
- MINI-BARBED TUBE
- POLY INDUSTRIAL COMPRESSION
- PIPE ADAPTERS
- ADAPTERS SAE FLARE
- THREADED SLEEVE
- KITS & ASSORTMENTS

Male Pipe to Female Pipe - 45°

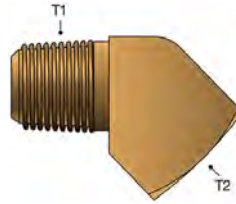

Part No.	Desc.			Standard Pack
		T1 (in)	T2 (in)	
G60618-0202	2MP-2FP45	1/8-27	1/8-27	1
G60618-0404	4MP-4FP45	1/4-18	1/4-18	1
G60618-0606	6MP-6FP45	3/8-18	3/8-18	1
G60618-0808	8MP-8FP45	1/2-14	1/2-14	1
G60618-1212	12MP-12FP45	3/4-14	3/4-14	1

Male Pipe to Female Pipe - 90°

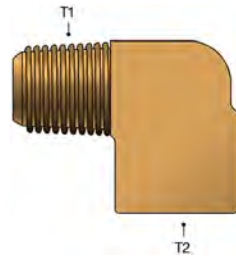

Part No.	Desc.			Standard Pack
		T1 (in)	T2 (in)	
G60620-0101	1MP-1FPB90	1/16-32	1/16-32	1
G60620-0202	2MP-2FPB90	1/8-27	1/8-27	1
G60620-0204	2MP-4FPB90	1/8-27	1/4-18	1
G60620-0402	4MP-2FPB90	1/4-18	1/8-27	1
G60620-0404	4MP-4FPB90	1/4-18	1/4-18	1
G60620-0406	4MP-6FPB90	1/4-18	3/8-18	1
G60620-0604	6MP-4FPB90	3/8-18	1/4-18	1
G60620-0606	6MP-6FPB90	3/8-18	3/8-18	1
G60620-0608	6MP-8FPB90	3/8-18	1/2-14	1
G60620-0806	8MP-6FPB90	1/2-14	3/8-18	1
G60620-0808	8MP-8FPB90	1/2-14	1/2-14	1
G60620-1212	12MP-12FPB90	3/4-14	3/4-14	1

AIR BRAKE
NYLON TUBING

AIR BRAKE
COPPER TUBING

AIR BRAKE
SURELOK

COMPOSITE AIR
BRAKE SURELOK

AIR BRAKE
COMPRESSION
FITTINGS

AIR BRAKE
COUPLINGS FOR
RUBBER HOSE

VALVES

BRASS LOCK-ON
FIELD
ATTACHABLE
COUPLINGS

SINGLE BEAD

BARB STEM

INVERTED FLARE

AUTOMOTIVE
ADAPTERS

COPPER TUBING
INDUSTRIAL
COMPRESSION

INDUSTRIAL
SURELOK

MINI-BARBED
TUBE

POLY
INDUSTRIAL
COMPRESSION

PIPE ADAPTERS

ADAPTERS SAE
FLARE

THREADED
SLEEVE

KITS &
ASSORTMENTS

Male Pipe to Female Pipe to Male SAE 45° Flare - Split Run Tee

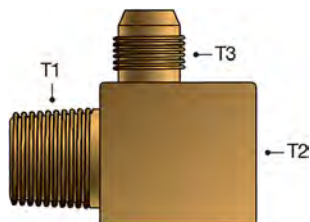

Part No.	Desc.				Standard Pack
		T1 (in)	T2 (in)	T3 (in)	
G60623-0203	2MP-2FP-3MS	1/8-27	1/8-27	3/8-24	1

Female Pipe to Female Pipe

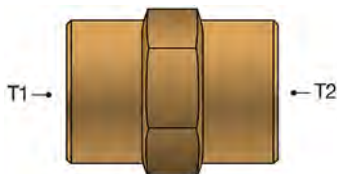

Part No.	Desc.			Standard Pack
		T1 (in)	T2 (in)	
G60631-0101	1FP-1FPB	1/16-32	1/16-32	1
G60631-0202	2FP-2FPB	1/8-27	1/8-27	1
G60631-0402	4FP-2FPB	1/4-18	1/8-27	1
G60631-0404	4FP-4FPB	1/4-18	1/4-18	1
G60631-0602	6FP-2FPB	3/8-18	1/8-27	1
G60631-0604	6FP-4FPB	3/8-18	1/4-18	1
G60631-0606	6FP-6FPB	3/8-18	3/8-18	1
G60631-0806	8FP-6FPB	1/2-14	3/8-18	1
G60631-0808	8FP-8FPB	1/2-14	1/2-14	1
G60631-1208	12FP-8FPB	3/4-14	1/2-14	1
G60631-1212	12FP-12FPB	3/4-14	3/4-14	1

Female Pipe to Female Pipe Swivel Union

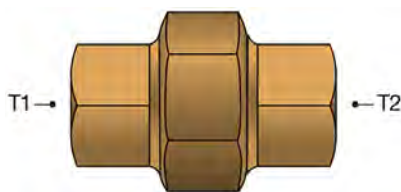



Part No.	Desc.			Standard Pack
		T1 (in)	T2 (in)	
G60632-0202	2FP-2FPXB	1/8-27	1/8-27	1
G60632-0404	4FP-4FPXB	1/4-18	1/4-18	1
G60632-0606	6FP-6FPXB	3/8-18	3/8-18	1
G60632-0808	8FP-8FPXB	1/2-14	1/2-14	1

Female Pipe to Female Pipe Swivel Union - Continued

Part No.	Desc.			Standard Pack
		T1 (in)	T2 (in)	
G60632-1212	12FP-12FPXB	3/4-14	3/4-14	1

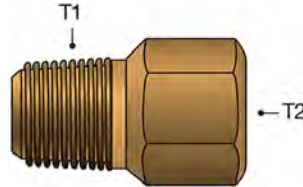
Male Pipe to Female Pipe - Restriction



Part No.	Desc.			Standard Pack
		T1 (in)	T2 (in)	
G60633-0202	2MP-2FPR	1/8-27	1/8-27	1

Female Pipe to Female Pipe - 45°



Part No.	Desc.			Standard Pack
		T1 (in)	T2 (in)	
G60635-0202	2FP-2FPB45	1/8-27	1/8-27	1
G60635-0404	4FP-4FPB45	1/4-18	1/4-18	1
G60635-0606	6FP-6FPB45	3/8-18	3/8-18	1
G60635-0808	8FP-8FPB45	1/2-14	1/2-14	1
G60635-1212	12FP-12FPB45	3/4-14	3/4-14	1

AIR BRAKE
NYLON TUBING

AIR BRAKE
COPPER TUBING

AIR BRAKE
SURELOK

COMPOSITE AIR
BRAKE SURELOK

AIR BRAKE
COMPRESSION
FITTINGS

AIR BRAKE
COUPLINGS FOR
RUBBER HOSE

VALVES

BRASS LOCK-ON
FIELD
ATTACHABLE
COUPLINGS

SINGLE BEAD

BARB STEM

INVERTED FLARE

AUTOMOTIVE
ADAPTERS

COPPER TUBING
INDUSTRIAL
COMPRESSION

INDUSTRIAL
SURELOK

MINI-BARBED
TUBE

POLY
INDUSTRIAL
COMPRESSION

PIPE ADAPTERS

ADAPTERS SAE
FLARE

THREADED
SLEEVE

KITS &
ASSORTMENTS

Female Pipe to Female Pipe - 90°

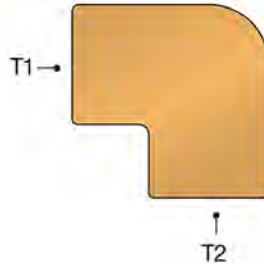

Part No.	Desc.			Standard Pack
		T1 (in)	T2 (in)	
G60637-0202	2FP-2FPB90	1/8-27	1/8-27	1
G60637-0204	2FP-4FPB90	1/8-27	1/4-18	1
G60637-0404	4FP-4FPB90	1/4-18	1/4-18	1
G60637-0406	4FP-6FPB90	1/4-18	3/8-18	1
G60637-0606	6FP-6FPB90	3/8-18	3/8-18	1
G60637-0608	6FP-8FPB90	3/8-18	1/2-14	1
G60637-0808	8FP-8FPB90	1/2-14	1/2-14	1
G60637-1212	12FP-12FPB90	3/4-14	3/4-14	1

Female Pipe - Cross

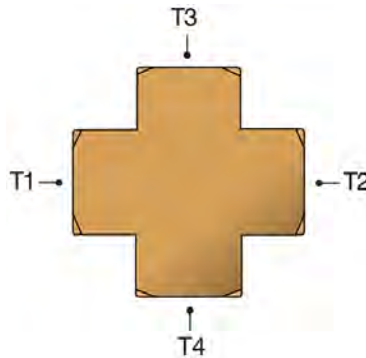

Part No.	Desc.					Standard Pack
		T1 (in)	T2 (in)	T3 (in)	T4 (in)	
G60639-0202	2FP-2FP-2FP-2FPB	1/8-27	1/8-27	1/8-27	1/8-27	1
G60639-0404	4FP-4FP-4FP-4FPB	1/4-18	1/4-18	1/4-18	1/4-18	1
G60639-0606	6FP-6FP-6FP-6FPB	3/8-18	3/8-18	3/8-18	3/8-18	1
G60639-0808	8FP-8FP-8FP-8FPB	1/2-14	1/2-14	1/2-14	1/2-14	1
G60639-1212	12FP-12FP-12FP-12FPB	3/4-14	3/4-14	3/4-14	3/4-14	1

- AIR BRAKE NYLON TUBING
- AIR BRAKE COPPER TUBING
- AIR BRAKE SURELOK
- COMPOSITE AIR BRAKE SURELOK
- AIR BRAKE COMPRESSION FITTINGS
- AIR BRAKE COUPLINGS FOR RUBBER HOSE
- VALVES
- BRASS LOCK-ON FIELD ATTACHABLE COUPLINGS
- SINGLE BEAD
- BARB STEM
- INVERTED FLARE
- AUTOMOTIVE ADAPTERS
- COPPER TUBING INDUSTRIAL COMPRESSION
- INDUSTRIAL SURELOK
- MINI-BARBED TUBE
- POLY INDUSTRIAL COMPRESSION
- PIPE ADAPTERS
- ADAPTERS SAE FLARE
- THREADED SLEEVE
- KITS & ASSORTMENTS

Female Pipe - Union Tee

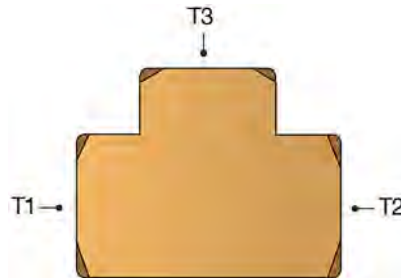

Part No.	Desc.	🌀			Standard Pack
		T1 (in)	T2 (in)	T3 (in)	
G60640-0101	1FP-1FP-1FPB	1/16-32	1/16-32	1/16-32	1
G60640-0202	2FP-2FP-2FPB	1/8-27	1/8-27	1/8-27	1
G60640-0204	2FP-2FP-4FPB	1/8-27	1/8-27	1/4-18	1
G60640-0402	4FP-4FP-2FPB	1/4-18	1/4-18	1/8-27	1
G60640-0404	4FP-4FP-4FPB	1/4-18	1/4-18	1/4-18	1
G60640-0604	6FP-6FP-4FPB	3/8-18	3/8-18	1/4-18	1
G60640-0606	6FP-6FP-6FPB	3/8-18	3/8-18	3/8-18	1
G60640-0806	8FP-8FP-6FPB	1/2-14	1/2-14	3/8-18	1
G60640-0808	8FP-8FP-8FPB	1/2-14	1/2-14	1/2-14	1
G60640-1208	12FP-12FP-8FPB	3/4-14	3/4-14	1/2-14	1
G60640-1212	12FP-12FP-12FPB	3/4-14	3/4-14	3/4-14	1

Male Pipe Run Tee to Female Pipe

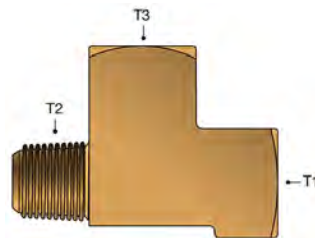

Part No.	Desc.	🌀			Standard Pack
		T1 (in)	T2 (in)	T3 (in)	
G60641-0202	2FP-2MP-2FPB	1/8-27	1/8-27	1/8-27	1
G60641-0404	4FP-4MP-4FPB	1/4-18	1/4-18	1/4-18	1
G60641-0606	6FP-6MP-6FPB	3/8-18	3/8-18	3/8-18	1
G60641-0808	8FP-8MP-8FPB	1/2-14	1/2-14	1/2-14	1
G60641-1212	12FP-12MP-12FPB	3/4-14	3/4-14	3/4-14	1

AIR BRAKE NYLON TUBING

AIR BRAKE COPPER TUBING

AIR BRAKE SURELOK

COMPOSITE AIR BRAKE SURELOK

AIR BRAKE COMPRESSION FITTINGS

AIR BRAKE COUPLINGS FOR RUBBER HOSE

VALVES

BRASS LOCK-ON FIELD ATTACHABLE COUPLINGS

SINGLE BEAD

BARB STEM

INVERTED FLARE

AUTOMOTIVE ADAPTERS

COPPER TUBING INDUSTRIAL COMPRESSION

INDUSTRIAL SURELOK

MINI-BARBED TUBE

POLY INDUSTRIAL COMPRESSION

PIPE ADAPTERS

ADAPTERS SAE FLARE

THREADED SLEEVE

KITS & ASSORTMENTS

Male Pipe Branch Tee to Female Pipe

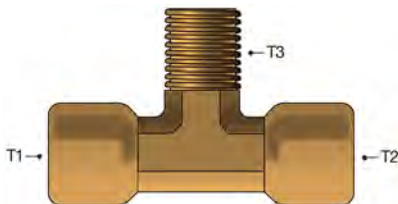

Part No.	Desc.				Standard Pack
		T1 (in)	T2 (in)	T3 (in)	
G60642-0202	2FP-2FP-2MPB	1/8-27	1/8-27	1/8-27	1
G60642-0404	4FP-4FP-4MPB	1/4-18	1/4-18	1/4-18	1
G60642-0606	6FP-6FP-6MPB	3/8-18	3/8-18	3/8-18	1
G60642-0808	8FP-8FP-8MPB	1/2-14	1/2-14	1/2-14	1
G60642-1212	12FP-12FP-12MPB	3/4-14	3/4-14	3/4-14	1

- AIR BRAKE NYLON TUBING
- AIR BRAKE COPPER TUBING
- AIR BRAKE SURELOK
- COMPOSITE AIR BRAKE SURELOK
- AIR BRAKE COMPRESSION FITTINGS
- AIR BRAKE COUPLINGS FOR RUBBER HOSE
- VALVES
- BRASS LOCK-ON FIELD ATTACHABLE COUPLINGS
- SINGLE BEAD
- BARB STEM
- INVERTED FLARE
- AUTOMOTIVE ADAPTERS
- COPPER TUBING INDUSTRIAL COMPRESSION
- INDUSTRIAL SURELOK
- MINI-BARBED TUBE
- POLY INDUSTRIAL COMPRESSION
- PIPE ADAPTERS**
- ADAPTERS SAE FLARE
- THREADED SLEEVE
- KITS & ASSORTMENTS

Tube O.D. (in)	1/8	3/16	1/4	5/16	3/8	7/16	1/2	5/8	3/4
Thread Size	5/16-28	3/8-24	7/16-24	1/2-20	5/8-18	11/16-18	3/4-18	7/8-18	1-1/16-16
PSI	2800	1900	1400	1200	1000	875	750	650	550

Recommended For: Air, fuel, oil, power steering, and water applications.

Used With: Copper, brass, aluminum, and flared steel tubing

Features and Benefits: Meets standard industry specifications; therefore, common tooling can quickly form the flared end on the tube to ensure a leak tight connection.

Conformance: ASME, SAE

Working Pressure: Up to 2,800 psi depending on the tube size. See chart above.

Temperature Range: -65°F to +250°F (-53° to +121°C)

Material: 360 Brass

Assembly Instructions:

1. Measure the desired length to be cut and mark the tube.
2. Cut the tube and ensure all burrs are removed and the ends are cut square.
3. Ensure the threaded end of the nut is facing out and slide the nut onto the tube.
4. Use a 45° flaring tool to flare the end of the tube. It is important to measure the flare diameter and to examine the flare for excessive thinning.
5. Lubricate the threads, assemble the connector body, and turn the nut until it is hand tight.
6. Using a wrench, tighten the assembly until a solid connection is felt and then apply a one-sixth turn.

AIR BRAKE
NYLON TUBING

AIR BRAKE
COPPER TUBING

AIR BRAKE
SURELOK

COMPOSITE AIR
BRAKE SURELOK

AIR BRAKE
COMPRESSION
FITTINGS

AIR BRAKE
COUPLINGS FOR
RUBBER HOSE

VALVES

BRASS LOCK-ON
FIELD
ATTACHABLE
COUPLINGS

SINGLE BEAD

BARB STEM

INVERTED FLARE

AUTOMOTIVE
ADAPTERS

COPPER TUBING
INDUSTRIAL
COMPRESSION

INDUSTRIAL
SURELOK

MINI-BARBED
TUBE

POLY
INDUSTRIAL
COMPRESSION

PIPE ADAPTERS

ADAPTERS SAE
FLARE

THREADED
SLEEVE

KITS &
ASSORTMENTS

Female SAE 45° Flare Cap

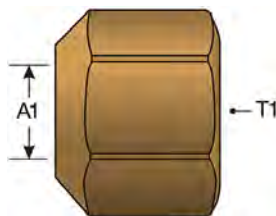

Part No.	Desc.	A1		Standard Pack
		"	T1 (in)	
G60643-0003	3FSCAP	3/16	3/8-24	1
G60643-0004	4FSCAP	1/4	7/16-20	1
G60643-0005	5FSCAP	5/16	1/2-20	1
G60643-0006	6FSCAP	3/8	5/8-18	1
G60643-0008	8FSCAP	1/2	3/4-16	1
G60643-0010	10FSCAP	5/8	7/8-14	1
G60643-0012	12FSCAP	3/4	1 1/16-14	1

Male SAE Plug

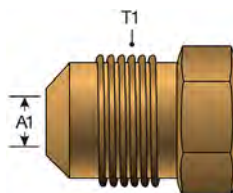

Part No.	Desc.	A1		Standard Pack
		"	T1 (in)	
G60644-0002	2MS-PLUG	1/8	5/16-24	1
G60644-0003	3MS-PLUG	3/16	3/8-24	1
G60644-0004	4MS-PLUG	1/4	7/16-20	1
G60644-0005	5MS-PLUG	5/16	1/2-20	1
G60644-0006	6MS-PLUG	3/8	5/8-18	1
G60644-0008	8MS-PLUG	1/2	3/4-16	1
G60644-0010	10MS-PLUG	5/8	7/8-14	1
G60644-0012	12MS-PLUG	3/4	1 1/16-14	1

Male SAE 45° Flare to Male SAE 45° Flare

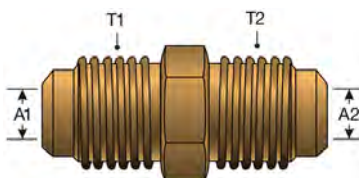



Part No.	Desc.	A1	A2		Standard Pack	
		"	"	T1 (in)		T2 (in)
G60645-0202	2MS-2MS	1/8	1/8	5/16-24	5/16-24	1

Male SAE 45° Flare to Male SAE 45° Flare - Continued

Part No.	Desc.	A1	A2			Standard Pack
		"	"	T1 (in)	T2 (in)	
G60645-0303	3MS-3MS	3/16	3/16	3/8-24	3/8-24	1
G60645-0403	4MS-3MS	1/4	3/16	7/16-20	3/8-24	1
G60645-0404	4MS-4MS	1/4	1/4	7/16-20	7/16-20	1
G60645-0504	5MS-4MS	5/16	1/4	1/2-20	7/16-20	1
G60645-0505	5MS-5MS	5/16	5/16	1/2-20	1/2-20	1
G60645-0604	6MS-4MS	3/8	1/4	5/8-18	7/16-20	1
G60645-0605	6MS-5MS	3/8	5/16	5/8-18	1/2-20	1
G60645-0606	6MS-6MS	3/8	3/8	5/8-18	5/8-18	1
G60645-0804	8MS-4MS	1/2	1/4	3/4-16	7/16-20	1
G60645-0806	8MS-6MS	1/2	3/8	3/4-16	5/8-18	1
G60645-0808	8MS-8MS	1/2	1/2	3/4-16	3/4-16	1
G60645-1006	10MS-6MS	5/8	3/8	7/8-14	5/8-18	1
G60645-1008	10MS-8MS	5/8	1/2	7/8-14	3/4-16	1
G60645-1010	10MS-10MS	5/8	5/8	7/8-14	7/8-14	1
G60645-1208	12MS-8MS	3/4	1/2	1 1/16-14	3/4-16	1
G60645-1210	12MS-10MS	3/4	5/8	1 1/16-14	7/8-14	1
G60645-1212	12MS-12MS	3/4	3/4	1 1/16-14	1 1/16-14	1

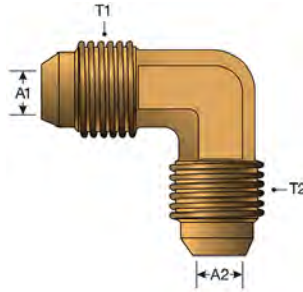
Male SAE 45° Flare to Male SAE 45° Flare - 90°



Part No.	Desc.	A1	A2			Standard Pack
		"	"	T1 (in)	T2 (in)	
G60648-0202	2MS-2MS90	1/8	1/8	5/16-24	5/16-24	1
G60648-0404	4MS-4MS90	1/4	1/4	7/16-20	7/16-20	1
G60648-0505	5MS-5MS90	5/16	5/16	1/2-20	1/2-20	1
G60648-0604	6MS-4MS90	3/8	1/4	5/8-18	7/16-20	1
G60648-0605	6MS-5MS90	3/8	5/16	5/8-18	1/2-20	1
G60648-0606	6MS-6MS90	3/8	3/8	5/8-18	5/8-18	1
G60648-0804	8MS-4MS90	1/2	1/4	3/4-16	7/16-20	1
G60648-0806	8MS-6MS90	1/2	3/8	3/4-16	5/8-18	1
G60648-0808	8MS-8MS90	1/2	1/2	3/4-16	3/4-16	1
G60648-1006	10MS-6MS90	5/8	3/8	7/8-14	5/8-18	1
G60648-1008	10MS-8MS90	5/8	1/2	7/8-14	3/4-16	1
G60648-1010	10MS-10MS90	5/8	5/8	7/8-14	7/8-14	1
G60648-1210	12MS-10MS90	3/4	5/8	1 1/16-14	7/8-14	1
G60648-1212	12MS-12MS90	3/4	3/4	1 1/16-14	1 1/16-14	1

- AIR BRAKE NYLON TUBING
- AIR BRAKE COPPER TUBING
- AIR BRAKE SURELOK
- COMPOSITE AIR BRAKE SURELOK
- AIR BRAKE COMPRESSION FITTINGS
- AIR BRAKE COUPLINGS FOR RUBBER HOSE
- VALVES
- BRASS LOCK-ON FIELD ATTACHABLE COUPLINGS
- SINGLE BEAD
- BARB STEM
- INVERTED FLARE
- AUTOMOTIVE ADAPTERS
- COPPER TUBING INDUSTRIAL COMPRESSION
- INDUSTRIAL SURELOK
- MINI-BARBED TUBE
- POLY INDUSTRIAL COMPRESSION
- PIPE ADAPTERS
- ADAPTERS SAE FLARE
- THREADED SLEEVE
- KITS & ASSORTMENTS

AIR BRAKE NYLON TUBING
AIR BRAKE COPPER TUBING
AIR BRAKE SURELOK
COMPOSITE AIR BRAKE SURELOK
AIR BRAKE COMPRESSION FITTINGS
AIR BRAKE COUPLINGS FOR RUBBER HOSE
VALVES
BRASS LOCK-ON FIELD ATTACHABLE COUPLINGS
SINGLE BEAD
BARB STEM
INVERTED FLARE
AUTOMOTIVE ADAPTERS
COPPER TUBING INDUSTRIAL COMPRESSION
INDUSTRIAL SURELOK
MINI-BARBED TUBE
POLY INDUSTRIAL COMPRESSION
PIPE ADAPTERS
ADAPTERS SAE FLARE
THREADED SLEEVE
KITS & ASSORTMENTS

Male SAE 45° Flare to Male Pipe

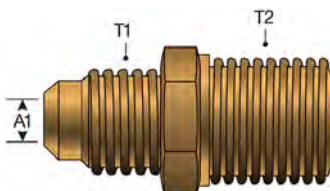

Part No.	Desc.	A1	T1 T2		Standard Pack
		"	T1 (in)	T2 (in)	
G60650-0202	2MS-2MP	1/8	5/16-24	1/8-27	1
G60650-0302	3MS-2MP	3/16	3/8-24	1/8-27	1
G60650-0402	4MS-2MP	1/4	7/16-20	1/8-27	1
G60650-0404	4MS-4MP	1/4	7/16-20	1/4-18	1
G60650-0406	4MS-6MP	1/4	7/16-20	3/8-18	1
G60650-0408	4MS-8MP	1/4	7/16-20	1/2-14	1
G60650-0502	5MS-2MP	5/16	1/2-20	1/8-27	1
G60650-0504	5MS-4MP	5/16	1/2-20	1/4-18	1
G60650-0506	5MS-6MP	5/16	1/2-20	3/8-18	1
G60650-0602	6MS-2MP	3/8	5/8-18	1/8-27	1
G60650-0604	6MS-4MP	3/8	5/8-18	1/4-18	1
G60650-0606	6MS-6MP	3/8	5/8-18	3/8-18	1
G60650-0608	6MS-8MP	3/8	5/8-18	1/2-14	1
G60650-0704	7MS-4MP	7/16	11/16-16	1/4-18	1
G60650-0804	8MS-4MP	1/2	3/4-16	1/4-18	1
G60650-0806	8MS-6MP	1/2	3/4-16	3/8-18	1
G60650-0808	8MS-8MP	1/2	3/4-16	1/2-14	1
G60650-0812	8MS-12MP	1/2	3/4-16	3/4-14	1
G60650-1006	10MS-6MP	5/8	7/8-14	3/8-18	1
G60650-1008	10MS-8MP	5/8	7/8-14	1/2-14	1
G60650-1012	10MS-12MP	5/8	7/8-14	3/4-14	1
G60650-1208	12MS-8MP	3/4	1 1/16-14	1/2-14	1
G60650-1212	12MS-12MP	3/4	1 1/16-14	3/4-14	1

Male SAE 45° Flare to Male Pipe - 45°

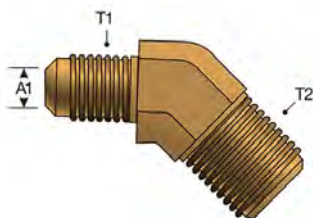



Part No.	Desc.	A1	T1 T2		Standard Pack
		"	T1 (in)	T2 (in)	
G60652-0402	4MS-2MP45	1/4	7/16-20	1/8-27	1
G60652-0404	4MS-4MP45	1/4	7/16-20	1/4-18	1
G60652-0502	5MS-2MP45	5/16	1/2-20	1/8-27	1
G60652-0504	5MS-4MP45	5/16	1/2-20	1/4-18	1
G60652-0604	6MS-4MP45	3/8	5/8-18	1/4-18	1
G60652-0606	6MS-6MP45	3/8	5/8-18	3/8-18	1
G60652-0608	6MS-8MP45	3/8	5/8-18	1/2-14	1
G60652-0806	8MS-6MP45	1/2	3/4-16	3/8-18	1
G60652-0808	8MS-8MP45	1/2	3/4-16	1/2-14	1

Male SAE 45° Flare to Male Pipe - 45° - Continued

Part No.	Desc.	A1			Standard Pack
		"	T1 (in)	T2 (in)	
G60652-1006	10MS-6MP45	5/8	7/8-14	3/8-18	1
G60652-1008	10MS-8MP45	5/8	7/8-14	1/2-14	1
G60652-1208	12MS-8MP45	3/4	1 1/16-14	1/2-14	1
G60652-1212	12MS-12MP45	3/4	1 1/16-14	3/4-14	1

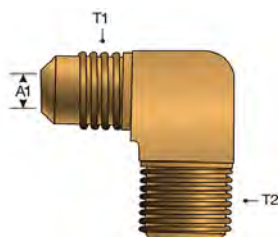
Male SAE 45° Flare to Male Pipe - 90°



Part No.	Desc.	A1			Standard Pack
		"	T1 (in)	T2 (in)	
G60654-0202	2MS-2MP90	1/8	5/16-24	1/8-27	1
G60654-0302	3MS-2MP90	3/16	3/8-24	1/8-27	1
G60654-0402	4MS-2MP90	1/4	7/16-20	1/8-27	1
G60654-0404	4MS-4MP90	1/4	7/16-20	1/4-18	1
G60654-0406	4MS-6MP90	1/4	7/16-20	3/8-18	1
G60654-0502	5MS-2MP90	5/16	1/2-20	1/8-27	1
G60654-0504	5MS-4MP90	5/16	1/2-20	1/4-18	1
G60654-0506	5MS-6MP90	5/16	1/2-20	3/8-18	1
G60654-0602	6MS-2MP90	3/8	5/8-18	1/8-27	1
G60654-0604	6MS-4MP90	3/8	5/8-18	1/4-18	1
G60654-0606	6MS-6MP90	3/8	5/8-18	3/8-18	1
G60654-0607	6MS-7MP90	3/8	5/8-18	3/8-18	1
G60654-0608	6MS-8MP90	3/8	5/8-18	1/2-14	1
G60654-0612	6MS-12MP90	3/8	5/8-18	3/4-14	1
G60654-0804	8MS-4MP90	1/2	3/4-16	1/4-18	1
G60654-0806	8MS-6MP90	1/2	3/4-16	3/8-18	1
G60654-0808	8MS-8MP90	1/2	3/4-16	1/2-14	1
G60654-0812	8MS-12MP90	1/2	3/4-16	3/4-14	1
G60654-1006	10MS-6MP90	5/8	7/8-14	3/8-18	1
G60654-1008	10MS-8MP90	5/8	7/8-14	1/2-14	1
G60654-1012	10MS-12MP90	5/8	7/8-14	3/4-14	1
G60654-1208	12MS-8MP90	3/4	1 1/16-14	1/2-14	1
G60654-1212	12MS-12MP90	3/4	1 1/16-14	3/4-14	1

AIR BRAKE
NYLON TUBING

AIR BRAKE
COPPER TUBING

AIR BRAKE
SURELOK

COMPOSITE AIR
BRAKE SURELOK

AIR BRAKE
COMPRESSION
FITTINGS

AIR BRAKE
COUPLINGS FOR
RUBBER HOSE

VALVES

BRASS LOCK-ON
FIELD
ATTACHABLE
COUPLINGS

SINGLE BEAD

BARB STEM

INVERTED FLARE

AUTOMOTIVE
ADAPTERS

COPPER TUBING
INDUSTRIAL
COMPRESSION

INDUSTRIAL
SURELOK

MINI-BARBED
TUBE

POLY
INDUSTRIAL
COMPRESSION

PIPE ADAPTERS

ADAPTERS SAE
FLARE

THREADED
SLEEVE

KITS &
ASSORTMENTS

Male SAE 45° Flare Run Tee to Male Pipe

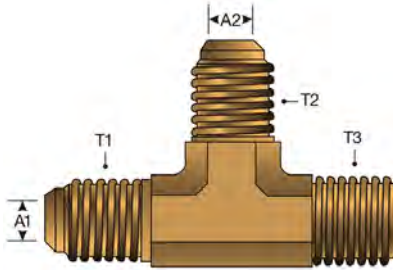

Part No.	Desc.	A1	A2				Standard Pack
		"	"	T1 (in)	T2 (in)	T3 (in)	
G60657-0202	2MS-2MS-2MP	1/8	1/8	5/16-24	5/16-24	1/8-27	1
G60657-0302	3MS-3MS-2MP	3/16	3/16	3/8-24	3/8-24	1/8-27	1
G60657-0402	4MS-4MS-2MP	1/4	1/4	7/16-20	7/16-20	1/8-27	1
G60657-0404	4MS-4MS-4MP	1/4	1/4	7/16-20	7/16-20	1/4-18	1
G60657-0406	4MS-4MS-6MP	1/4	1/4	7/16-20	7/16-20	3/8-18	1
G60657-0408	4MS-4MS-8MP	1/4	1/4	7/16-20	7/16-20	1/2-14	1
G60657-0502	5MS-5MS-2MP	5/16	5/16	1/2-20	1/2-20	1/8-27	1
G60657-0504	5MS-5MS-4MP	5/16	5/16	1/2-20	1/2-20	1/4-18	1
G60657-0602	6MS-6MS-2MP	3/8	3/8	5/8-18	5/8-18	1/8-27	1
G60657-0604	6MS-6MS-4MP	3/8	3/8	5/8-18	5/8-18	1/4-18	1
G60657-0606	6MS-6MS-6MP	3/8	3/8	5/8-18	5/8-18	3/8-18	1
G60657-0608	6MS-6MS-8MP	3/8	3/8	5/8-18	5/8-18	1/2-14	1
G60657-0804	8MS-8MS-4MP	1/2	1/2	3/4-16	3/4-16	1/4-18	1
G60657-0806	8MS-8MS-6MP	1/2	1/2	3/4-16	3/4-16	3/8-18	1
G60657-0808	8MS-8MS-8MP	1/2	1/2	3/4-16	3/4-16	1/2-14	1
G60657-0812	8MS-8MS-12MP	1/2	1/2	3/4-16	3/4-16	3/4-14	1
G60657-1008	10MS-10MS-8MP	5/8	5/8	7/8-14	7/8-14	1/2-14	1
G60657-1012	10MS-10MS-12MP	5/8	5/8	7/8-14	7/8-14	3/4-14	1
G60657-1208	12MS-12MS-8MP	3/4	3/4	1 1/16-14	1 1/16-14	1/2-14	1
G60657-1212	12MS-12MS-12MP	3/4	3/4	1 1/16-14	1 1/16-14	3/4-14	1

Male SAE 45° Flare Branch Tee to Male Pipe

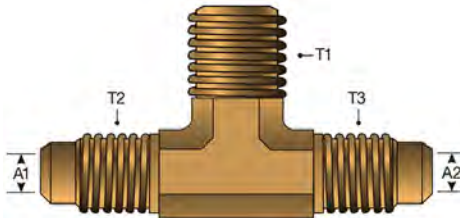



Part No.	Desc.	A1	A2				Standard Pack
		"	"	T1 (in)	T2 (in)	T3 (in)	
G60659-0203	2MP-3MS-3MS	3/16	3/16	1/8-27	3/8-24	3/8-24	1
G60659-0204	2MP-4MS-4MS	1/4	1/4	1/8-27	7/16-20	7/16-20	1
G60659-0205	2MP-5MS-5MS	5/16	5/16	1/8-27	1/2-20	1/2-20	1
G60659-0206	2MP-6MS-6MS	3/8	3/8	1/8-27	5/8-18	5/8-18	1
G60659-0404	4MP-4MS-4MS	1/4	1/4	1/4-18	7/16-20	7/16-20	1
G60659-0405	4MP-5MS-5MS	5/16	5/16	1/4-18	1/2-20	1/2-20	1
G60659-0406	4MP-6MS-6MS	3/8	3/8	1/4-18	5/8-18	5/8-18	1
G60659-0408	4MP-8MS-8MS	1/2	1/2	1/4-18	3/4-16	3/4-16	1

Male SAE 45° Flare Branch Tee to Male Pipe - Continued

Part No.	Desc.	A1	A2				Standard Pack
		"	"	T1 (in)	T2 (in)	T3 (in)	
G60659-0604	6MP-4MS-4MS	1/4	1/4	3/8-18	7/16-20	7/16-20	1
G60659-0606	6MP-6MS-6MS	3/8	3/8	3/8-18	5/8-18	5/8-18	1
G60659-0608	6MP-8MS-8MS	1/2	1/2	3/8-18	3/4-16	3/4-16	1
G60659-0610	6MP-10MS-10MS	5/8	5/8	3/8-18	7/8-14	7/8-14	1
G60659-0806	8MP-6MS-6MS	3/8	3/8	1/2-14	5/8-18	5/8-18	1
G60659-0808	8MP-8MS-8MS	1/2	1/2	1/2-14	3/4-16	3/4-16	1
G60659-0810	8MP-10MS-10MS	5/8	5/8	1/2-14	7/8-14	7/8-14	1
G60659-0812	8MP-12MS-12MS	3/4	3/4	1/2-14	1 1/16-14	1 1/16-14	1
G60659-1212	12MP-12MS-12MS	3/4	3/4	3/4-14	1 1/16-14	1 1/16-14	1

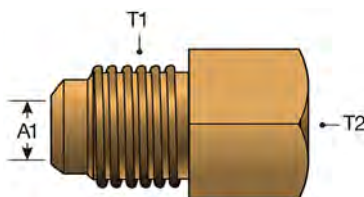
Male SAE 45° Flare to Female Pipe



Part No.	Desc.	A1			Standard Pack
		"	T1 (in)	T2 (in)	
G60660-0202	2MS-2FP	1/8	5/16-24	1/8-27	1
G60660-0302	3MS-2FP	3/16	3/8-24	1/8-27	1
G60660-0402	4MS-2FP	1/4	7/16-20	1/8-27	1
G60660-0404	4MS-4FP	1/4	7/16-20	1/4-18	1
G60660-0406	4MS-6FP	1/4	7/16-20	3/8-18	1
G60660-0408	4MS-8FP	1/4	7/16-20	1/2-14	1
G60660-0502	5MS-2FP	5/16	1/2-20	1/8-27	1
G60660-0504	5MS-4FP	5/16	1/2-20	1/4-18	1
G60660-0506	5MS-6FP	5/16	1/2-20	3/8-18	1
G60660-0602	6MS-2FP	3/8	1/2-20	1/8-27	1
G60660-0604	6MS-4FP	3/8	5/8-18	1/4-18	1
G60660-0606	6MS-6FP	3/8	5/8-18	3/8-18	1
G60660-0608	6MS-8FP	3/8	5/8-18	1/2-14	1
G60660-0804	8MS-4FP	1/2	3/4-16	1/4-18	1
G60660-0806	8MS-6FP	1/2	3/4-16	3/8-18	1
G60660-0808	8MS-8FP	1/2	3/4-16	1/2-14	1
G60660-1006	10MS-6FP	5/8	7/8-14	3/8-18	1
G60660-1008	10MS-8FP	5/8	7/8-14	1/2-14	1
G60660-1012	10MS-12FP	5/8	7/8-14	3/4-14	1
G60660-1208	12MS-8FP	3/4	1 1/16-14	1/2-14	1

- AIR BRAKE NYLON TUBING
- AIR BRAKE COPPER TUBING
- AIR BRAKE SURELOK
- COMPOSITE AIR BRAKE SURELOK
- AIR BRAKE COMPRESSION FITTINGS
- AIR BRAKE COUPLINGS FOR RUBBER HOSE
- VALVES
- BRASS LOCK-ON FIELD ATTACHABLE COUPLINGS
- SINGLE BEAD
- BARB STEM
- INVERTED FLARE
- AUTOMOTIVE ADAPTERS
- COPPER TUBING INDUSTRIAL COMPRESSION
- INDUSTRIAL SURELOK
- MINI-BARBED TUBE
- POLY INDUSTRIAL COMPRESSION
- PIPE ADAPTERS
- ADAPTERS SAE FLARE
- THREADED SLEEVE
- KITS & ASSORTMENTS

Male SAE 45° Flare to Female Pipe - 90°

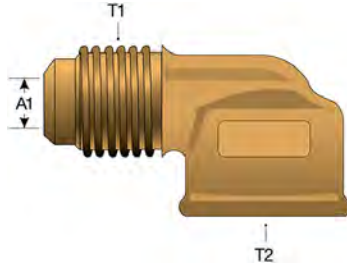

Part No.	Desc.	A1	T		Standard Pack
		"	T1 (in)	T2 (in)	
G60664-0302	3MS-2FP90	3/16	3/8-24	1/8-27	1
G60664-0402	4MS-2FP90	1/4	7/16-20	1/8-27	1
G60664-0404	4MS-4FP90	1/4	7/16-20	1/4-18	1
G60664-0406	4MS-6FP90	1/4	7/16-20	3/8-18	1
G60664-0502	5MS-2FP90	5/16	1/2-20	1/8-27	1
G60664-0504	5MS-4FP90	5/16	1/2-20	1/4-18	1
G60664-0604	6MS-4FP90	3/8	5/8-18	1/4-18	1
G60664-0606	6MS-6FP90	3/8	5/8-18	3/8-18	1
G60664-0806	8MS-6FP90	1/2	3/4-16	3/8-18	1
G60664-0808	8MS-8FP90	1/2	3/4-16	1/2-14	1
G60664-1006	10MS-6FP90	5/8	7/8-14	3/8-18	1
G60664-1008	10MS-8FP90	5/8	7/8-14	1/2-14	1
G60664-1208	12MS-8FP90	3/4	1 1/16-14	1/2-14	1
G60664-1212	12MS-12FP90	3/4	1 1/16-14	3/4-14	1

SAE 45° Flare Union Tee Brass

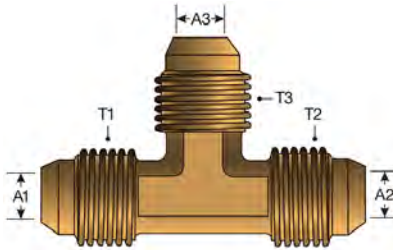

Part No.	Desc.	A1	A2	A3	T			Standard Pack
		"	"	"	T1 (in)	T2 (in)	T3 (in)	
G60669-0202	2MS-2MS-2MS	1/8	1/8	1/8	5/16-24	5/16-24	5/16-24	1
G60669-0303	3MS-3MS-3MS	3/16	3/16	3/16	3/8-24	3/8-24	3/8-24	1
G60669-0404	4MS-4MS-4MS	1/4	1/4	1/4	7/16-20	7/16-20	7/16-20	1
G60669-0406	4MS-4MS-6MS	1/4	1/4	3/8	7/16-20	7/16-20	5/8-18	1
G60669-0504	5MS-5MS-4MS	5/16	5/16	1/4	1/2-20	1/2-20	7/16-20	1
G60669-0505	5MS-5MS-5MS	5/16	5/16	5/16	1/2-20	1/2-20	1/2-20	1
G60669-0604	6MS-6MS-4MS	3/8	3/8	1/4	5/8-18	5/8-18	7/16-20	1
G60669-0606	6MS-6MS-6MS	3/8	3/8	3/8	5/8-18	5/8-18	5/8-18	1
G60669-0608	6MS-6MS-8MS	3/8	3/8	1/2	5/8-18	5/8-18	3/4-16	1
G60669-0610	6MS-6MS-10MS	3/8	3/8	5/8	5/8-18	5/8-18	7/8-14	1
G60669-0804	8MS-8MS-4MS	1/2	1/2	1/4	3/4-16	3/4-16	7/16-20	1
G60669-0806	8MS-8MS-6MS	1/2	1/2	3/8	3/4-16	3/4-16	5/8-18	1
G60669-0808	8MS-8MS-8MS	1/2	1/2	1/2	3/4-16	3/4-16	3/4-16	1
G60669-0810	8MS-8MS-10MS	1/2	1/2	5/8	3/4-16	3/4-16	7/8-14	1

SAE 45° Flare Union Tee Brass - Continued

Part No.	Desc.	A1	A2	A3				Standard Pack
		"	"	"	T1 (in)	T2 (in)	T3 (in)	
G60669-0812	8MS-8MS-12MS	1/2	1/2	3/4	3/4-16	3/4-16	1 1/16-14	1
G60669-1004	10MS-10MS-4MS	5/8	5/8	1/4	7/8-14	7/8-14	7/16-20	1
G60669-1006	10MS-10MS-6MS	5/8	5/8	3/8	7/8-14	7/8-14	5/8-18	1
G60669-1008	10MS-10MS-8MS	5/8	5/8	1/2	7/8-14	7/8-14	3/4-16	1
G60669-1010	10MS-10MS-10MS	5/8	5/8	5/8	7/8-14	7/8-14	7/8-14	1
G60669-1208	12MS-12MS-8MS	3/4	3/4	1/2	1 1/16-14	1 1/16-14	3/4-16	1
G60669-1210	12MS-12MS-10MS	3/4	3/4	5/8	1 1/16-14	1 1/16-14	7/8-14	1
G60669-1212	12MS-12MS-12MS	3/4	3/4	3/4	1 1/16-14	1 1/16-14	1 1/16-14	1
G60670-0604	6MS-4MS-4MS	3/8	1/4	1/4	5/8-18	7/16-20	7/16-20	1
G60670-0806	8MS-6MS-6MS	1/2	3/8	3/8	3/4-16	5/8-18	5/8-18	1
G60670-1006	10MS-6MS-6MS	5/8	3/8	3/8	7/8-14	5/8-18	5/8-18	1
G60670-1008	10MS-8MS-8MS	5/8	1/2	1/2	7/8-14	3/4-16	3/4-16	1
G60671-0604	6MS-4MS-6MS	3/8	1/4	3/8	5/8-18	7/16-20	5/8-18	1
G60671-0804	8MS-4MS-8MS	1/2	1/4	1/2	3/4-16	7/16-20	3/4-16	1
G60671-0806	8MS-6MS-8MS	1/2	3/8	1/2	3/4-16	5/8-18	3/4-16	1
G60671-1006	10MS-6MS-10MS	5/8	3/8	5/8	7/8-14	5/8-18	7/8-14	1
G60671-1008	10MS-8MS-10MS	5/8	1/2	5/8	7/8-14	3/4-16	7/8-14	1
G60671-1210	12MS-10MS-12MS	3/4	5/8	3/4	1 1/16-14	7/8-14	1 1/16-14	1

Female SAE 45° Flare Nut - Short



Part No.	Desc.	A1		Standard Pack
		"	T1 (in)	
G60675-0002	2FSN-S	1/8	5/16-24	1
G60675-0003	3FSN-S	3/16	3/8-24	1
G60675-0004	4FSN-S	1/4	7/16-20	1
G60675-0005	5FSN-S	5/16	1/2-20	1
G60675-0006	6FSN-S	3/8	5/8-18	1
G60675-0007	7FSN-S	7/16	11/16-16	1
G60675-0008	8FSN-S	1/2	3/4-16	1
G60675-0010	10FSN-S	5/8	7/8-14	1
G60675-0012	12FSN-S	3/4	1 1/16-14	1

AIR BRAKE
NYLON TUBING

AIR BRAKE
COPPER TUBING

AIR BRAKE
SURELOK

COMPOSITE AIR
BRAKE SURELOK

AIR BRAKE
COMPRESSION
FITTINGS

AIR BRAKE
COUPLINGS FOR
RUBBER HOSE

VALVES

BRASS LOCK-ON
FIELD
ATTACHABLE
COUPLINGS

SINGLE BEAD

BARB STEM

INVERTED FLARE

AUTOMOTIVE
ADAPTERS

COPPER TUBING
INDUSTRIAL
COMPRESSION

INDUSTRIAL
SURELOK

MINI-BARBED
TUBE

POLY
INDUSTRIAL
COMPRESSION

PIPE ADAPTERS

ADAPTERS SAE
FLARE

THREADED
SLEEVE

KITS &
ASSORTMENTS

Female SAE 45° Flare Nut - Long



Part No.	Desc.	A1		Standard Pack
		"	T1 (in)	
G60676-0003	3FSN-L	3/16	3/8-24	1
G60676-0004	4FSN-L	1/4	7/16-20	1
G60676-0005	5FSN-L	5/16	1/2-20	1
G60676-0006	6FSN-L	3/8	5/8-18	1
G60676-0008	8FSN-L	1/2	3/4-16	1
G60676-0010	10FSN-L	5/8	7/8-14	1

Male SAE 45° Flare - Cross

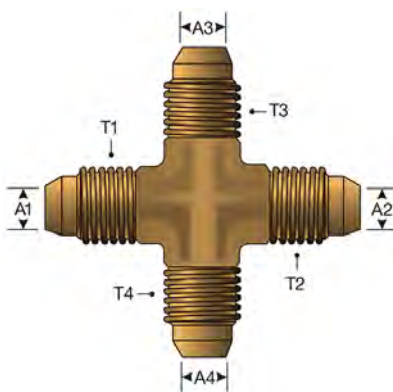

Part No.	Desc.	A1	A2	A3	A4					Standard Pack
		"	"	"	"	T1 (in)	T2 (in)	T3 (in)	T4 (in)	
G60680-0404	4MSCROSS	1/4	1/4	1/4	1/4	7/16-20	7/16-20	7/16-20	7/16-20	1
G60680-0505	5MSCROSS	5/16	5/16	5/16	5/16	1/2-20	1/2-20	1/2-20	1/2-20	1
G60680-0606	6MSCROSS	3/8	3/8	3/8	3/8	5/8-18	5/8-18	5/8-18	5/8-18	1
G60680-0808	8MSCROSS	1/2	1/2	1/2	1/2	3/4-16	3/4-16	3/4-16	3/4-16	1

Male SAE 45° Flare to Male Pipe - Check Valve

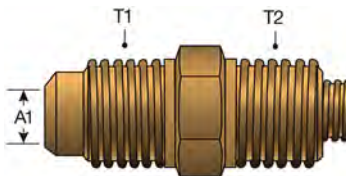

Part No.	Desc.	A1			Standard Pack
		"	T1 (in)	T2 (in)	
G60690-0204	2MS-4MP-CV	1/8	5/16-24	1/4-18	1
G60690-0402	4MS-2MP-CV	1/4	7/16-20	1/8-27	1
G60690-0502	5MS-2MP-CV	5/16	1/2-20	1/8-27	1
G60690-0604	6MS-4MP-CV	3/8	5/8-18	1/4-18	1

AIR BRAKE
NYLON TUBING

AIR BRAKE
COPPER TUBING

AIR BRAKE
SURELOK

COMPOSITE AIR
BRAKE SURELOK

AIR BRAKE
COMPRESSION
FITTINGS

AIR BRAKE
COUPLINGS FOR
RUBBER HOSE

VALVES

BRASS LOCK-ON
FIELD
ATTACHABLE
COUPLINGS

SINGLE BEAD

BARB STEM

INVERTED FLARE

AUTOMOTIVE
ADAPTERS

COPPER TUBING
INDUSTRIAL
COMPRESSION

INDUSTRIAL
SURELOK

MINI-BARBED
TUBE

POLY
INDUSTRIAL
COMPRESSION

PIPE ADAPTERS

ADAPTERS SAE
FLARE

THREADED
SLEEVE

KITS &
ASSORTMENTS

AIR BRAKE NYLON TUBING
AIR BRAKE COPPER TUBING
AIR BRAKE SURELOK
COMPOSITE AIR BRAKE SURELOK
AIR BRAKE COMPRESSION FITTINGS
AIR BRAKE COUPLINGS FOR RUBBER HOSE
VALVES
BRASS LOCK-ON FIELD ATTACHABLE COUPLINGS
SINGLE BEAD
BARB STEM
INVERTED FLARE
AUTOMOTIVE ADAPTERS
COPPER TUBING INDUSTRIAL COMPRESSION
INDUSTRIAL SURELOK
MINI-BARBED TUBE
POLY INDUSTRIAL COMPRESSION
PIPE ADAPTERS
ADAPTERS SAE FLARE
THREADED SLEEVE
KITS & ASSORTMENTS

Tube O.D. (in)	1/8	3/16	1/4	5/16	3/8
Thread Size	5/16-24	3/8-24	7/16-24	1/2-20	9/16-20

Recommended For: Air, oil, water, and lubrication systems.

Used With: Copper and aluminum tubing only

Features and Benefits: Flaring is not required; easy to assemble.

Conformance: ASME

Working Pressure: 500 psi (34 bar)

Temperature Range: -65°F to +250°F (-53° to +121°C)

Material: 360 Brass

Assembly Instructions:

1. Measure the tube and cut to the desired length.
2. Slide nut on end of tube. Threaded end of nut must face connector.
3. Insert the tube into the connector body until it bottoms out on the connector shoulder.
4. Assemble the nut to the connector body and tighten nut hand tight.
5. From hand tight, tighten with a wrench 1-1/2 additional turns.

Threaded Sleeve Nut

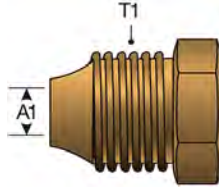

Part No.	Desc.	A1		Standard Pack
		"	T1 (in)	
G60593-0202	2DCN	1/8	5/16-24	1
G60593-0303	3DCN	3/16	3/8-24	1
G60593-0404	4DCN	1/4	7/16-24	1
G60593-0505	5DCN	5/16	1/2-20	1
G60593-0606	6DCN	3/8	9/16-20	1

Threaded Sleeve to Male Pipe

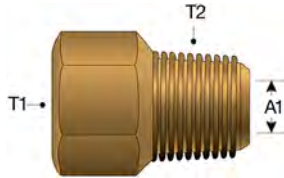

Part No.	Desc.	A1			Standard Pack
		"	T1 (in)	T2 (in)	
G60594-0202	2DCN-2MP	1/8	5/16-24	1/8-27	1
G60594-0302	3DCN-2MP	3/16	3/8-24	1/8-27	1
G60594-0402	4DCN-2MP	1/4	7/16-24	1/8-27	1
G60594-0502	5DCN-2MP	5/16	1/2-20	1/8-27	1
G60594-0604	6DCN-4MP	3/8	9/16-20	1/4-18	1

Threaded Sleeve to Male Pipe - 90°

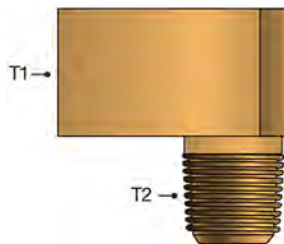

Part No.	Desc.			Standard Pack
		T1 (in)	T2 (in)	
G60595-0202	2DCN-2MP90	5/16-24	1/8-27	1
G60595-0221	2DCN-21MP90	5/16-24	1/4-28	1
G60595-0302	3DCN-2MP90	3/8-24	1/8-27	1
G60595-0402	4DCN-2MP90	7/16-24	1/8-27	1
G60595-0502	5DCN-2MP90	1/2-20	1/8-27	1

- AIR BRAKE NYLON TUBING
- AIR BRAKE COPPER TUBING
- AIR BRAKE SURELOK
- COMPOSITE AIR BRAKE SURELOK
- AIR BRAKE COMPRESSION FITTINGS
- AIR BRAKE COUPLINGS FOR RUBBER HOSE
- VALVES
- BRASS LOCK-ON FIELD ATTACHABLE COUPLINGS
- SINGLE BEAD
- BARB STEM
- INVERTED FLARE
- AUTOMOTIVE ADAPTERS
- COPPER TUBING INDUSTRIAL COMPRESSION
- INDUSTRIAL SURELOK
- MINI-BARBED TUBE
- POLY INDUSTRIAL COMPRESSION
- PIPE ADAPTERS
- ADAPTERS SAE FLARE
- THREADED SLEEVE
- KITS & ASSORTMENTS

Threaded Sleeve to Male Pipe - 90° - Continued

Part No.	Desc.			Standard Pack
		T1 (in)	T2 (in)	
G60595-0604	6DCN-4MP90	9/16-20	1/4-18	1

AIR BRAKE NYLON TUBING
AIR BRAKE COPPER TUBING
AIR BRAKE SURELOK
COMPOSITE AIR BRAKE SURELOK
AIR BRAKE COMPRESSION FITTINGS
AIR BRAKE COUPLINGS FOR RUBBER HOSE
VALVES
BRASS LOCK-ON FIELD ATTACHABLE COUPLINGS
SINGLE BEAD
BARB STEM
INVERTED FLARE
AUTOMOTIVE ADAPTERS
COPPER TUBING INDUSTRIAL COMPRESSION
INDUSTRIAL SURELOK
MINI-BARBED TUBE
POLY INDUSTRIAL COMPRESSION
PIPE ADAPTERS
ADAPTERS SAE FLARE
THREADED SLEEVE
KITS & ASSORTMENTS

SureLok™ Coupling Assortments

Air Line Repair Kit – Part No. 85111 —————→



Air Brake Repair Kit – Part No. 85112 —————→



Transmission Line Repair Kit – Part No. 85113 —————→



Tubing Repair Kit – Part No. 85114 —————→



Small SureLok™ Assortment – Part No. A33001

Assortment includes:

- 4 sizes of hose
- 16 coupling configurations
- 158 individual couplings

Large SureLok™ Assortment – Part No. A33002

Assortment includes:

- 7 sizes of hose
- 51 coupling configurations
- 318 individual couplings

Small Compression Assortment – Part No. A33003

Assortment includes:

- 4 sizes of hose
- 31 coupling configurations
- 211 individual couplings

Large Compression Assortment – Part No. A33004

Assortment includes:

- 7 sizes of hose
- 59 coupling configurations
- 330 individual couplings

Air Brake Couplings for Rubber Hose and C14 (PTFE) Assembly Assortments

Air Brake Hose Rack – Part No. 91180 —————→

Small Air Brake Assortment – Part No. 91182

Assortment includes:

- 1 Air Brake Hose Rack Part No. 91180
- 16 assemblies

Large Air Brake Assortment – Part No. 91181

Assortment includes:

- 2 Air Brake Hose Racks Part No. 91180
- 31 assemblies



AIR BRAKE
NYLON TUBING

AIR BRAKE
COPPER TUBING

AIR BRAKE
SURELOK

COMPOSITE AIR
BRAKE SURELOK

AIR BRAKE
COMPRESSION
FITTINGS

AIR BRAKE
COUPLINGS FOR
RUBBER HOSE

VALVES

BRASS LOCK-ON
FIELD
ATTACHABLE
COUPLINGS

SINGLE BEAD

BARB STEM

INVERTED FLARE

AUTOMOTIVE
ADAPTERS

COPPER TUBING
INDUSTRIAL
COMPRESSION

INDUSTRIAL
SURELOK

MINI-BARBED
TUBE

POLY
INDUSTRIAL
COMPRESSION

PIPE ADAPTERS

ADAPTERS SAE
FLARE

THREADED
SLEEVE

KITS &
ASSORTMENTS

Competitive Interchange

AIR BRAKE NYLON TUBING
AIR BRAKE COPPER TUBING
AIR BRAKE SURELOK
COMPOSITE AIR BRAKE SURELOK
AIR BRAKE COMPRESSION FITTINGS
AIR BRAKE COUPLINGS FOR RUBBER HOSE
VALVES
BRASS LOCK-ON FIELD ATTACHABLE COUPLINGS
SINGLE BEAD
BARB STEM
INVERTED FLARE
AUTOMOTIVE ADAPTERS
COPPER TUBING INDUSTRIAL COMPRESSION
INDUSTRIAL SURELOK
MINI-BARBED TUBE
POLY INDUSTRIAL COMPRESSION
PIPE ADAPTERS
ADAPTERS SAE FLARE
THREADED SLEEVE
KITS & ASSORTMENTS

Interchange No.	Gates No.	Interchange No.	Gates No.	Interchange No.	Gates No.	Interchange No.	Gates No.
ALKON		ALKON - CONT.		ANDERSON BRASS - CONT.		ANDERSON BRASS - CONT.	
AQ54-DOT-10X8	G31102-1008	AQ72-DOTS-8X4	G31142-0804	119A-CA	G60631-0602	302-44	G36195-0404
AQ54-DOT-4X2	G31102-0402	AQ72-DOTS-8X8	G31142-0808	119A-CB	G60631-0604	302-45	G36195-0405
AQ54-DOT-4X4	G31102-0404	AQ82-DOT-4	G31300-0404	119A-DC	G60631-0806	302-66	G36195-0606
AQ54-DOT-6X2	G31102-0602	AQ82-DOT-6	G31300-0606	119A-ED	G60631-1208	302-88	G36195-0808
AQ54-DOT-6X4	G31102-0604	AQ82-DOT-8	G31300-0808	120A-AA	G60615-0202	304-1212	G36535-1212
AQ54-DOT-6X6	G31102-0606	AQ86-DOT-4X4	G31360-0404	120A-BA	G60615-0204	304-44	G36535-0404
AQ54-DOT-6X8	G31102-0608	AQ86-DOT-6X4	G31360-0604	120A-BB	G60615-0404	304-55	G36535-0505
AQ54-DOT-8X4	G31102-0804	AQ86-DOT-6X6	G31360-0606	120A-CA	G60615-0206	304-66	G36535-0606
AQ54-DOT-8X6	G31102-0806	ANDERSON BRASS		120A-CB	G60615-0406	304-88	G36535-0808
AQ54-DOT-8X8	G31102-0808	6	G33832-0202	120A-CC	G60615-0606	305-43	G36500-0403
AQ59-P-4	G31050-0004	8	G33832-0606	120A-DB	G60615-0408	305-44	G36500-0404
AQ59-P-5/32	G31050-0025	9	G33832-0808	120A-DC	G60615-0608	305-45	G36500-0405
AQ59-P-6	G31050-0006	46	G33805-0202	120A-DD	G60615-0808	305-54	G36500-0504
AQ59-P-8	G31050-0008	47	G33805-0404	120A-ED	G60615-0812	305-55	G36500-0505
AQ62-DOT-4	G31400-0404	48	G33805-0606	121A-A	G60601-0002	305-56	G36500-0506
AQ62-DOT-6	G31400-0606	100A-A	G60637-0202	121A-B	G60601-0004	305-66	G36500-0606
AQ62-DOT-8	G31400-0808	100A-B	G60637-0404	121A-C	G60601-0006	305-88	G36500-0808
AQ64-DOT-4	G31450-0404	100A-BA	G60637-0204	121A-D	G60601-0008	306-88	G36508-0808
AQ64-DOT-6	G31450-0606	100A-C	G60637-0606	121A-E	G60601-0012	307-1212	G36200-1212
AQ64-DOT-8	G31450-0808	100A-CB	G60637-0406	122A-A	G60605-0202	307-46	G36200-0406
AQ-68-DOT-10X6	G31100-1006	100A-D	G60637-0808	122A-B	G60605-0404	307-66	G36200-0606
AQ-68-DOT-10X8	G31100-1008	100A-DC	G60637-0608	122A-D	G60605-0808	308-88	G36210-0808
AQ-68-DOT-3X2	G31100-0302	100A-E	G60637-1212	122A-E	G60605-1212	309-1010	G36210-1010
AQ-68-DOT-4X1	G31100-0401	101A-A	G60640-0202	123A-BA	G60605-0204	309-44	G36210-0404
AQ-68-DOT-4X2	G31100-0402	101A-B	G60640-0404	123A-CA	G60605-0206	309-45	G36210-0405
AQ-68-DOT-4X4	G31100-0404	101A-BBA	G60640-0402	123A-CB	G60605-0406	309-55	G36210-0505
AQ-68-DOT-4X6	G31100-0406	101A-C	G60640-0606	123A-DB	G60605-0408	309-65	G36210-0605
AQ68-DOT-5/32X1	G31100-2501	101A-CCB	G60640-0604	123A-DC	G60605-0606	3099-44	G36110-0404
AQ68-DOT-5/32X2	G31100-2502	101A-D	G60640-0808	123A-ED	G60605-0812	3099-66	G36110-0606
AQ-68-DOT-6X2	G31100-0602	101A-DDC	G60640-0806	124A-A	G60635-0202	3099-88	G36110-0808
AQ-68-DOT-6X4	G31100-0604	101A-E	G60640-1212	124A-B	G60635-0404	30CC	G33701-0505
AQ-68-DOT-6X6	G31100-0606	101CP	G33910-0402	124A-C	G60635-0606	30SAE	G33730-0505
AQ-68-DOT-6X8	G31100-0608	102A-A	G60641-0202	124A-D	G60635-0808	31NV	G33930-0202
AQ-68-DOT-8X4	G31100-0804	103A-A	G60631-0202	124A-E	G60635-1212	31PC	G33715-0202
AQ-68-DOT-8X6	G31100-0806	103A-B	G60631-0404	127A-B	G60641-0404	32NV	G33930-0404
AQ-68-DOT-8X8	G31100-0808	103A-C	G60631-0606	127A-C	G60641-0606	32PC	G33715-0404
AQ-69-DOT-10X6	G31104-1006	103A-D	G60631-0808	127A-D	G60641-0808	360A-6	G33050-0006
AQ-69-DOT-10X8	G31104-1008	103A-E	G60631-1212	127A-E	G60641-1212	360A-8	G33050-0008
AQ-69-DOT-4X2	G31104-0402	103CC	G33905-0402	128A-BA	G60620-0204	361A-6	G33060-0006
AQ-69-DOT-4X4	G31104-0404	104A-A	G60632-0202	128A-CB	G60620-0406	361A-6G	G33061-0006
AQ-69-DOT-4X6	G31104-0406	104A-B	G60632-0404	143CP	G33910-0604	361A-8	G33060-0008
AQ-69-DOT-6X2	G31104-0602	104A-C	G60632-0606	200D	G33830-0002	361A-8G	G33061-0008
AQ-69-DOT-6X4	G31104-0604	104A-D	G60632-0808	201D	G33830-0004	362A-6	G33400-0606
AQ-69-DOT-6X6	G31104-0606	104A-E	G60632-1212	202D	G33830-0006	362A-8	G33400-0808
AQ-69-DOT-6X8	G31104-0608	104SAE	G33940-0402	203CC	G33905-0502	368A-6B	G33100-0604
AQ-69-DOT-8X4	G31104-0804	105SAE	G33940-0404	203SAE	G33945-0502	368A-6C	G33100-0606
AQ-69-DOT-8X6	G31104-0806	106CC	G33901-0404	204SAE	G33945-0504	368A-6D	G33100-0608
AQ-69-DOT-8X8	G31104-0808	107CC	G33901-0505	227CC	G33705-0404	368A-8C	G33100-0806
AQ-69-DOTS-4X2	G31124-0402	108A-A	G60600-0002	227SAE	G33720-0404	368A-8D	G33100-0808
AQ-69-DOTS-4X4	G31124-0404	108A-B	G60600-0004	229CC	G33705-0504	371AS-6	G33112-0006
AQ-69-DOTS-4X6	G31124-0406	108A-C	G60600-0006	229SAE	G33720-0504	371AS-8	G33112-0008
AQ-69-DOTS-6X2	G31124-0602	108A-D	G60600-0008	262PPDOT-4	G31400-0404	378A-6B	G33110-0604
AQ-69-DOTS-6X4	G31124-0604	108A-E	G60600-0012	262PPDOT-6	G31400-0606	378A-6C	G33110-0606
AQ-69-DOTS-6X6	G31124-0606	108SAE	G33940-0604	27CC	G33705-0402	378A-6D	G33110-0608
AQ-69-DOTS-6X8	G31124-0608	108SD-2	G33650-0202	27SAE	G33720-0402	378A-8C	G33110-0806
AQ-69-DOTS-8X4	G31124-0804	108SD-4	G33650-0404	28CC	G33701-0404	378A-8D	G33110-0808
AQ-69-DOTS-8X6	G31124-0806	108SD-6	G33650-0606	28SAE	G33730-0404	388A-12B	G33030-0604
AQ-69-DOTS-8X8	G31124-0808	110MP	G33910-0404	29CC	G33705-0502	388A-12C	G33030-0606
AQ71-DOT-4X4	G31130-0404	110SAE	G33950-0404	301-1010	G36535-1010	388A-14C	G33030-0806
AQ71-DOT-6X4	G31130-0604	113CC	G33901-0606	301-108	G36100-1008	388A-14D	G33030-0808
AQ71-DOT-8X8	G31130-0808	114SD	G33655-0404	301-1212	G36100-1212	38D	G33832-0404
AQ71-DOTS-4X2	G31140-0204	115SD	G33656-0404	301-128	G36100-1208	40PC	G33715-0606
AQ71-DOTS-4X4	G31140-0404	116A-A	G60620-0202	301-42	G36100-0402	41D	G33801-0002
AQ71-DOTS-4X6	G31140-0406	116A-B	G60620-0404	301-44	G36100-0404	41P-3	G60691-0003
AQ71-DOTS-6X4	G31140-0604	116A-C	G60620-0606	301-46	G36100-0406	41P-4	G60691-0004
AQ71-DOTS-8X6	G31140-0806	116A-D	G60620-0808	301-52	G36100-0502	41P-5	G60691-0005
AQ72-DOT-4X2	G31134-0402	116A-E	G60620-1212	301-54	G36100-0504	41P-6	G60691-0006
AQ72-DOT-4X4	G31134-0404	116AM-A	G60610-0202	301-62	G36100-0602	421D	G33831-0004
AQ72-DOT-6X4	G31134-0604	116AM-B	G60610-0404	301-64	G36100-0604	42D	G33801-0004
AQ72-DOT-6X6	G31134-0606	116AM-BA	G60610-0204	301-66	G36100-0606	42I-2	G60693-0002
AQ72-DOT-8X4	G31134-0804	116AM-C	G60610-0606	301-66	G36105-0606	42I-3	G60693-0003
AQ72-DOT-8X6	G31134-0806	116AM-CB	G60610-0406	301-68	G36100-0608	42I-4	G60693-0004
AQ72-DOTS-4X2	G31142-0402	116AM-D	G60612-0202	301-812	G36100-0812	42I-5	G60693-0005
AQ72-DOTS-4X4	G31142-0404	119A-BA	G60631-0402	301-84	G36100-0804	42I-6	G60693-0006
AQ72-DOTS-6X4	G31142-0604			301-86	G36100-0806	42I-8	G60693-0008
AQ72-DOTS-6X6	G31142-0606			301-88	G36100-0808	43D	G33801-0006

Competitive Interchange

Interchange No.	Gates No.	Interchange No.	Gates No.	Interchange No.	Gates No.	Interchange No.	Gates No.
ANDERSON BRASS - CONT.		ANDERSON BRASS - CONT.		ANDERSON BRASS - CONT.		ANDERSON BRASS - CONT.	
44D.....	G33801-0008	68NAB-6A.....	G32100-0602	E1-45-5A.....	G60652-0502	T1-2A.....	G60657-0202
46I-3A.....	G60630-0302	68NAB-6B.....	G32100-0604	E1-45-5B.....	G60652-0504	T1-3A.....	G60657-0302
46I-4A.....	G60630-0402	68NAB-6C.....	G32100-0606	E1-45-6A.....	G60652-0604	T1-4A.....	G60657-0402
46I-5A.....	G60630-0502	68NAB-6D.....	G32100-0608	E1-45-6C.....	G60652-0606	T1-4B.....	G60657-0404
46I-6B.....	G60630-0604	68NAB-8B.....	G32100-0804	E1-45-6D.....	G60652-0608	T1-4C.....	G60657-0406
46I-8C.....	G60630-0806	68NAB-8C.....	G32100-0806	E1-45-8C.....	G60652-0806	T1-5A.....	G60657-0502
48I-10D.....	G60625-1008	68NAB-8D.....	G32100-0808	E1-45-8D.....	G60652-0808	T1-5B.....	G60657-0504
48I-2A.....	G60625-0202	68SAE.....	G33730-0808	E1-4A.....	G60654-0402	T1-6A.....	G60657-0602
48I-3A.....	G60625-0302	69NAB-10C.....	G32104-1006	E1-4B.....	G60654-0404	T1-6B.....	G60657-0604
48I-4A.....	G60625-0402	69NAB-10D.....	G32104-1008	E1-4C.....	G60654-0406	T1-6C.....	G60657-0606
48I-4B.....	G60625-0404	69NAB-12D.....	G32104-1208	E1-5A.....	G60654-0502	T1-6D.....	G60657-0608
48I-5A.....	G60625-0502	69NAB-4A.....	G32104-0402	E1-5B.....	G60654-0504	T1-8B.....	G60657-0804
48I-5B.....	G60625-0504	69NAB-4B.....	G32104-0404	E1-5C.....	G60654-0506	T1-8C.....	G60657-0806
48I-6A.....	G60625-0602	69NAB-4C.....	G32104-0406	E1-6A.....	G60654-0602	T1-8D.....	G60657-0808
48I-6B.....	G60625-0604	69NAB-6A.....	G32104-0602	E1-6B.....	G60654-0604	T2-10.....	G60669-1010
48I-6C.....	G60625-0606	69NAB-6B.....	G32104-0604	E1-6C.....	G60654-0606	T2-12.....	G60669-1212
48I-8B.....	G60625-0804	69NAB-6C.....	G32104-0606	E1-6D.....	G60654-0608	T2-2.....	G60669-0202
48I-8C.....	G60625-0806	69NAB-6D.....	G32104-0608	E1-8B.....	G60654-0804	T2-3.....	G60669-0303
48I-8D.....	G60625-0808	69NAB-8B.....	G32104-0804	E1-8C.....	G60654-0806	T2-4.....	G60669-0404
48NV.....	G33920-0202	69NAB-8C.....	G32104-0806	E1-8D.....	G60654-0808	T2-5.....	G60669-0505
48PC.....	G33710-0202	69NAB-8D.....	G32104-0808	E1-8E.....	G60654-0812	T2-6.....	G60669-0606
49NV.....	G33920-0404	70NAB-4A.....	G32154-0402	E2-10.....	G60648-1010	T2-8.....	G60669-0808
49PC.....	G33710-0404	70NAB-6A.....	G32154-0602	E2-12.....	G60648-1212	T3-10D.....	G60659-0810
50PC.....	G33710-0606	70NAB-6B.....	G32154-0604	E2-2.....	G60648-0202	T3-12D.....	G60659-0812
557CC.....	G33705-0606	70NAB-6C.....	G32154-0606	E2-4.....	G60648-0404	T3-12E.....	G60659-1212
557SAE.....	G33720-0606	70NAB-8C.....	G32154-0806	E2-5.....	G60648-0505	T3-3A.....	G60659-0203
57CC.....	G33705-0604	70NAB-8D.....	G32154-0808	E2-6.....	G60648-0606	T3-4A.....	G60659-0204
57SAE.....	G33720-0604	71NAB-4A.....	G32130-0204	E2-8.....	G60648-0808	T3-4B.....	G60659-0404
58CC.....	G33701-0606	71NAB-4B.....	G32130-0404	E3-10D.....	G60664-1008	T3-4C.....	G60659-0604
58SAE.....	G33730-0606	71NAB-6B.....	G32130-0406	E3-12E.....	G60664-1212	T3-5A.....	G60659-0205
59A-10.....	G32040-0010	71NAB-6C.....	G32130-0606	E3-3A.....	G60664-0302	T3-5B.....	G60659-0405
59A-12.....	G32040-0012	71NAB-8C.....	G32130-0608	E3-4A.....	G60664-0402	T3-6A.....	G60659-0206
59A-4.....	G32040-0004	71NAB-8D.....	G32130-0808	E3-4B.....	G60664-0404	T3-6B.....	G60659-0406
59A-6.....	G32040-0006	72NAB-10D.....	G32134-1008	E3-5A.....	G60664-0502	T3-6C.....	G60659-0606
59A-8.....	G32040-0008	72NAB-4A.....	G32134-0402	E3-5B.....	G60664-0504	T3-6D.....	G60659-0806
59SAE.....	G33720-0502	72NAB-4B.....	G32134-0404	E3-6B.....	G60664-0604	T3-8C.....	G60659-0608
60NAB-10.....	G32050-0010	72NAB-6A.....	G32134-0602	E3-6C.....	G60664-0606	T3-8D.....	G60659-0808
60NAB-12.....	G32050-0012	72NAB-6B.....	G32134-0604	E3-8C.....	G60664-0806	T9-222.....	G60642-0202
60NAB-4.....	G32050-0004	72NAB-6C.....	G32134-0606	E3-8D.....	G60664-0808	T9-444.....	G60642-0404
60NAB-6.....	G32050-0006	72NAB-8C.....	G32134-0806	ER2-106.....	G60648-1006	T9-666.....	G60642-0606
60NAB-8.....	G32050-0008	72NAB-8D.....	G32134-0808	ER2-108.....	G60648-1008	T9-888.....	G60642-0808
61NAB-10.....	G32060-0010	77SAE.....	G33720-0808	ER2-1210.....	G60648-1210	TR2-10106.....	G60670-1006
61NAB-12.....	G32060-0012	79NAB-10D.....	G32102-1008	ER2-128.....	G60648-1208	TR2-10108.....	G60670-1008
61NAB-4.....	G32060-0004	79NAB-4A.....	G32102-0402	ER2-64.....	G60648-0604	TR2-10810.....	G60671-1008
61NAB-6.....	G32060-0006	79NAB-4B.....	G32102-0404	ER2-84.....	G60648-0804	TR2-446.....	G60669-0406
61NAB-8.....	G32060-0008	79NAB-6A.....	G32102-0602	ER2-86.....	G60648-0806	TR2-6106.....	G60669-1006
62NAB-10.....	G32400-1010	79NAB-6B.....	G32102-0604	HBPHV-6C.....	G33622-0606	TR2-664.....	G60669-0604
62NAB-12.....	G32400-1212	79NAB-6C.....	G32102-0606	HV1-10C.....	G33620-1006	TR2-668.....	G60669-0608
62NAB-4.....	G32400-0404	79NAB-6D.....	G32102-0608	HV1-10D.....	G33620-1008	TR2-866.....	G60670-0806
62NAB-6.....	G32400-0606	79NAB-8C.....	G32102-0806	HV1-12C.....	G33620-1206	TR2-868.....	G60671-0806
62NAB-8.....	G32400-0808	79NAB-8D.....	G32102-0808	HV1-12D.....	G33620-1208	TR2-8810.....	G60669-0810
62NABH-6.....	G32300-0606	80PC.....	G33715-0808	HV1-6C.....	G33620-0606	TR2-886.....	G60669-0806
62NABH-8.....	G32300-0808	B1-10.....	G60684-0010	HV1-8C.....	G33620-0806	U1-10C.....	G60650-1006
64NAB-10.....	G32450-1010	B1-4.....	G60684-0004	N2-10.....	G60685-0010	U1-10D.....	G60650-1008
64NAB-4.....	G32450-0404	B1-6.....	G60684-0006	N2-12.....	G60685-0012	U1-10E.....	G60650-1012
64NAB-6.....	G32450-0606	B1-8.....	G60684-0008	N2-4.....	G60685-0004	U1-12D.....	G60650-1208
64NAB-8.....	G32450-0808	B368A-6B.....	G33111-0604	N2-5.....	G60685-0005	U1-12E.....	G60650-1212
65NAB-10.....	G32404-1010	B368A-6C.....	G33111-0606	N2-6.....	G60685-0006	U1-2A.....	G60650-0202
65NAB-4.....	G32404-0404	B368A-6D.....	G33111-0608	N2-8.....	G60685-0008	U1-3A.....	G60650-0302
65NAB-6.....	G32404-0606	B368A-8C.....	G33111-0806	N5-10.....	G60643-0010	U1-4A.....	G60650-0402
65NAB-8.....	G32404-0808	B368A-8D.....	G33111-0808	N5-12.....	G60643-0012	U1-4B.....	G60650-0404
66NAB-4A.....	G32150-0402	C1-4444.....	G60680-0404	N5-3.....	G60643-0003	U1-4C.....	G60650-0406
66NAB-4B.....	G32150-0404	C1-6666.....	G60680-0606	N5-4.....	G60643-0004	U1-4D.....	G60650-0408
66NAB-6A.....	G32150-0602	C1-8888.....	G60680-0808	N5-5.....	G60643-0005	U1-5A.....	G60650-0502
66NAB-6B.....	G32150-0604	E1-10C.....	G60654-1006	N5-6.....	G60643-0006	U1-5B.....	G60650-0504
66NAB-6C.....	G32150-0606	E1-10D.....	G60654-1008	N5-8.....	G60643-0008	U1-5C.....	G60650-0506
66NAB-8C.....	G32150-0806	E1-10E.....	G60654-1012	P2-10.....	G60644-0010	U1-6A.....	G60650-0602
67SAE.....	G33720-0806	E1-12D.....	G60654-1208	P2-12.....	G60644-0012	U1-6B.....	G60650-0604
68CC.....	G33701-0808	E1-12E.....	G60654-1212	P2-3.....	G60644-0003	U1-6C.....	G60650-0606
68NAB-10C.....	G32100-1006	E1-2A.....	G60654-0202	P2-4.....	G60644-0004	U1-6D.....	G60650-0608
68NAB-10D.....	G32100-1008	E1-3A.....	G60654-0302	P2-5.....	G60644-0005	U1-8B.....	G60650-0804
68NAB-12D.....	G32100-1208	E1-45-10D.....	G60652-1008	P2-6.....	G60644-0006	U1-8C.....	G60650-0806
68NAB-12E.....	G32100-1212	E1-45-12D.....	G60652-1208	P2-8.....	G60644-0008	U1-8D.....	G60650-0808
68NAB-4A.....	G32100-0402	E1-45-12E.....	G60652-1212	T1-10D.....	G60657-1008	U1-8E.....	G60650-0812
68NAB-4B.....	G32100-0404	E1-45-4A.....	G60652-0402	T1-12D.....	G60657-1208	U2-10.....	G60645-1010
68NAB-4C.....	G32100-0406	E1-45-4B.....	G60652-0404	T1-12E.....	G60657-1212	U2-12.....	G60645-1212

AIR BRAKE NYLON TUBING
AIR BRAKE COPPER TUBING
AIR BRAKE SURELOK
COMPOSITE AIR BRAKE SURELOK
AIR BRAKE COMPRESSION FITTINGS
AIR BRAKE COUPLINGS FOR RUBBER HOSE
VALVES
BRASS LOCK-ON FIELD ATTACHABLE COUPLINGS
SINGLE BEAD
BARB STEM
INVERTED FLARE
AUTOMOTIVE ADAPTERS
COPPER TUBING INDUSTRIAL COMPRESSION
INDUSTRIAL SURELOK
MINI-BARBED TUBE
POLY INDUSTRIAL COMPRESSION
PIPE ADAPTERS
ADAPTERS SAE FLARE
THREADED SLEEVE
KITS & ASSORTMENTS

Competitive Interchange

AIR BRAKE NYLON TUBING
AIR BRAKE COPPER TUBING
AIR BRAKE SURELOK
COMPOSITE AIR BRAKE SURELOK
AIR BRAKE COMPRESSION FITTINGS
AIR BRAKE COUPLINGS FOR RUBBER HOSE
VALVES
BRASS LOCK-ON FIELD ATTACHABLE COUPLINGS
SINGLE BEAD
BARB STEM
INVERTED FLARE
AUTOMOTIVE ADAPTERS
COPPER TUBING INDUSTRIAL COMPRESSION
INDUSTRIAL SURELOK
MINI-BARBED TUBE
POLY INDUSTRIAL COMPRESSION
PIPE ADAPTERS
ADAPTERS SAE FLARE
THREADED SLEEVE
KITS & ASSORTMENTS

Interchange No.	Gates No.	Interchange No.	Gates No.	Interchange No.	Gates No.	Interchange No.	Gates No.
ANDERSON BRASS - CONT.		ANDERSON FIT. - CONT.		ANDERSON FIT. - CONT.		ANDERSON FIT. - CONT.	
U2-2	G60645-0202	00468-0602	G32100-0602	04040-08	G60643-0008	04048-0602	G60650-0602
U2-3	G60645-0303	00468-0604	G32100-0604	04040-10	G60643-0010	04048-0604	G60650-0604
U2-4	G60645-0404	00468-0606	G32100-0606	04040-12	G60643-0012	04048-0606	G60650-0606
U2-5	G60645-0505	00468-0608	G32100-0608	04041-04	G60685-0004	04048-0608	G60650-0608
U2-6	G60645-0606	00468-0804	G32100-0804	04041-05	G60685-0005	04048-0804	G60650-0804
U2-8	G60645-0808	00468-0806	G32100-0806	04041-06	G60685-0006	04048-0806	G60650-0806
U3-10D	G60660-1008	00468-0808	G32100-0808	04041-08	G60685-0008	04048-0808	G60650-0808
U3-10E	G60660-1012	00468-1006	G32100-1006	04041-10	G60685-0010	04048-0812	G60650-0812
U3-12D	G60660-1208	00468-1008	G32100-1008	04041-12	G60685-0012	04048-1008	G60650-1008
U3-12E	G60660-1212	00468-1208	G32100-1208	04042-02	G60645-0202	04048-1012	G60650-1012
U3-3A	G60660-0302	00468-1212	G32100-1212	04042-03	G60645-0303	04048-1208	G60650-1208
U3-4A	G60660-0402	00469-0402	G32104-0402	04042-04	G60645-0404	04048-1212	G60650-1212
U3-4B	G60660-0404	00469-0404	G32104-0404	04042-05	G60645-0505	04049-0202	G60654-0202
U3-4C	G60660-0406	00469-0406	G32104-0406	04042-06	G60645-0606	04049-0302	G60654-0302
U3-4D	G60660-0408	00469-0602	G32104-0602	04042-08	G60645-0808	04049-0402	G60654-0402
U3-5A	G60660-0502	00469-0604	G32104-0604	04042-10	G60645-1010	04049-0404	G60654-0404
U3-5B	G60660-0504	00469-0606	G32104-0606	04042-12	G60645-1212	04049-0406	G60654-0406
U3-6A	G60660-0602	00469-0608	G32104-0608	04043-0402	G60690-0402	04049-0502	G60654-0502
U3-6B	G60660-0604	00469-0804	G32104-0804	04043-0604	G60690-0604	04049-0504	G60654-0504
U3-6C	G60660-0606	00469-0806	G32104-0806	04044-02	G60669-0202	04049-0506	G60654-0506
U3-6D	G60660-0608	00469-0808	G32104-0808	04044-03	G60669-0303	04049-0602	G60654-0602
U3-8B	G60660-0804	00469-1006	G32104-1006	04044-04	G60669-0404	04049-0604	G60654-0604
U3-8C	G60660-0806	00469-1008	G32104-1008	04044-05	G60669-0505	04049-0606	G60654-0606
U3-8D	G60660-0808	00469-1208	G32104-1208	04044-06	G60669-0606	04049-0608	G60654-0608
UR2-106	G60645-1006	00470-0402	G32154-0402	04044-08	G60669-0808	04049-0804	G60654-0804
UR2-108	G60645-1008	00470-0404	G32154-0404	04044-10	G60669-1010	04049-0806	G60654-0806
UR2-1210	G60645-1210	00470-0602	G32154-0602	04044-12	G60669-1212	04049-0808	G60654-0808
UR2-128	G60645-1208	00470-0604	G32154-0604	04045-0202	G60657-0202	04049-0812	G60654-0812
UR2-64	G60645-0604	00470-0606	G32154-0606	04045-0302	G60657-0302	04049-1006	G60654-1006
UR2-65	G60645-0605	00470-0806	G32154-0806	04045-0402	G60657-0402	04049-1008	G60654-1008
UR2-84	G60645-0804	00470-0808	G32154-0808	04045-0404	G60657-0404	04049-1012	G60654-1012
UR2-86	G60645-0806	00470-1008	G32154-1008	04045-0406	G60657-0406	04049-1208	G60654-1208
ANDERSON FITTINGS		00471-0402	G32130-0204	04045-0408	G60657-0408	04049-1212	G60654-1212
00397-02	G33300-0202	00471-0404	G32130-0404	04045-0502	G60657-0502	04050-0302	G60664-0302
00397-04	G33300-0606	00471-0604	G32130-0406	04045-0504	G60657-0504	04050-0402	G60664-0402
00397-06	G33302-0804	00471-0606	G32130-0606	04045-0602	G60657-0602	04050-0404	G60664-0404
00397-08	G33300-0404	00471-0806	G32130-0608	04045-0604	G60657-0604	04050-0502	G60664-0502
00398-04	G33301-0404	00471-0808	G32130-0808	04045-0606	G60657-0606	04050-0504	G60664-0504
00460-04	G32050-0004	00471-1008	G32130-0810	04045-0608	G60657-0608	04050-0604	G60664-0604
00460-06	G32050-0006	00472-0402	G32134-0402	04045-0804	G60657-0804	04050-0606	G60664-0606
00460-08	G32050-0008	00472-0404	G32134-0404	04045-0806	G60657-0806	04050-0806	G60664-0806
00460-10	G32050-0010	00472-0602	G32134-0602	04045-0808	G60657-0808	04050-0808	G60664-0808
00460-12	G32050-0012	00472-0604	G32134-0604	04045-0812	G60657-0812	04050-1008	G60664-1008
00461-04	G32060-0004	00472-0606	G32134-0606	04045-1008	G60657-1008	04050-1212	G60664-1212
00461-06	G32060-0006	00472-0806	G32134-0806	04045-1012	G60657-1012	04051-0302	G60659-0203
00461-08	G32060-0008	00472-0808	G32134-0808	04045-1208	G60657-1208	04051-0402	G60659-0204
00461-10	G32060-0010	00472-1008	G32134-1008	04045-1212	G60657-1212	04051-0404	G60659-0404
00461-12	G32060-0012	00473-04	G32040-0004	04046-0202	G60660-0202	04051-0406	G60659-0604
00462-04	G32400-0404	00473-06	G32040-0006	04046-0302	G60660-0302	04051-0502	G60659-0205
00462-06	G32400-0606	00473-08	G32040-0008	04046-0402	G60660-0402	04051-0504	G60659-0405
00462-08	G32400-0808	00473-10	G32040-0010	04046-0404	G60660-0404	04051-0602	G60659-0206
00462-10	G32400-1010	00473-12	G32040-0012	04046-0406	G60660-0406	04051-0604	G60659-0406
00462-12	G32400-1212	00483-04	G32300-0404	04046-0408	G60660-0408	04051-0606	G60659-0606
00464-04	G32450-0404	00483-06	G32300-0606	04046-0502	G60660-0502	04051-0608	G60659-0806
00464-06	G32450-0606	00483-08	G32300-0808	04046-0504	G60660-0504	04051-0806	G60659-0608
00464-08	G32450-0808	00483-10	G32300-1010	04046-0506	G60660-0506	04051-0808	G60659-0808
00464-10	G32450-1010	00495-0402	G32102-0402	04046-0602	G60660-0602	04051-1008	G60659-0810
00465-04	G32404-0404	00495-0404	G32102-0404	04046-0604	G60660-0604	04051-1208	G60659-0812
00465-06	G32404-0606	00495-0602	G32102-0602	04046-0606	G60660-0606	04051-1212	G60659-1212
00465-08	G32404-0808	00495-0604	G32102-0604	04046-0608	G60660-0608	04052-04	G60680-0404
00465-10	G32404-1010	00495-0606	G32102-0606	04046-0804	G60660-0804	04052-05	G60680-0505
00466-0402	G32150-0402	00495-0608	G32102-0608	04046-0806	G60660-0806	04052-06	G60680-0606
00466-0404	G32150-0404	00495-0806	G32102-0806	04046-0808	G60660-0808	04052-08	G60680-0808
00466-0602	G32150-0602	00495-0808	G32102-0808	04046-1008	G60660-1008	04055-02	G60648-0202
00466-0604	G32150-0604	00495-1008	G32102-1008	04046-1012	G60660-1012	04055-04	G60648-0404
00466-0606	G32150-0606	04039-03	G60644-0003	04046-1208	G60660-1208	04055-05	G60648-0505
00466-0806	G32150-0806	04039-04	G60644-0004	04046-1212	G60660-1212	04055-06	G60648-0606
00466-0808	G32150-0808	04039-05	G60644-0005	04048-0202	G60650-0202	04055-08	G60648-0808
00466-1006	G32150-1006	04039-06	G60644-0006	04048-0302	G60650-0302	04055-10	G60648-1010
00466-1008	G32150-1008	04039-08	G60644-0008	04048-0402	G60650-0402	04055-12	G60648-1212
00466-1208	G32150-1208	04039-10	G60644-0010	04048-0404	G60650-0404	04056-0403	G60645-0403
00468-0402	G32100-0402	04039-12	G60644-0012	04048-0406	G60650-0406	04056-0504	G60645-0504
00468-0404	G32100-0404	04040-03	G60643-0003	04048-0408	G60650-0408	04056-0604	G60645-0604
00468-0406	G32100-0406	04040-04	G60643-0004	04048-0502	G60650-1006	04056-0605	G60645-0605
00468-0406	G32100-0406	04040-05	G60643-0005	04048-0504	G60650-0504	04056-0804	G60645-0804
		04040-06	G60643-0006	04048-0506	G60650-0506	04056-0806	G60645-0806

Competitive Interchange

Interchange No.	Gates No.	Interchange No.	Gates No.	Interchange No.	Gates No.	Interchange No.	Gates No.
ANDERSON FIT. - CONT.		ANDERSON FIT. - CONT.		ANDERSON FIT. - CONT.		ANDERSON FIT. - CONT.	
04056-1006	G60645-1006	06108-02	G60600-0002	06228-0806	G60620-0608	07206-1010	G36500-1010
04056-1008	G60645-1008	06108-04	G60600-0004	06230-02	G60610-0202	07207-0404	G36110-0404
04056-1208	G60645-1208	06108-06	G60600-0006	06230-04	G60610-0404	07207-0504	G36110-0504
04056-1210	G60645-1210	06108-08	G60600-0008	06230-06	G60610-0606	07207-0606	G36110-0606
04059-040406	G60669-0406	06108-12	G60600-0012	06230-08	G60610-0808	07207-0806	G36110-0806
04059-060604	G60669-0604	06119-0402	G60631-0402	06231-02	G60642-0202	07207-0808	G36110-0808
04059-060608	G60669-0608	06119-0602	G60631-0602	06231-04	G60642-0404	07207-1008	G36110-1008
04059-080606	G60670-0806	06119-0604	G60631-0604	06231-06	G60642-0606	07207-1212	G36110-1212
04059-080608	G60671-0806	06119-0806	G60631-0806	06231-08	G60642-0808	07208-0402	G36111-0402
04059-080806	G60669-0806	06119-1208	G60631-1208	06232-02	G60612-0202	07208-0404	G36111-0404
04059-080810	G60669-0810	06120-0202	G60615-0202	06232-04	G60612-0404	07208-0406	G36111-0406
04059-100606	G60669-1006	06120-0402	G60615-0204	06232-06	G60612-0606	07208-0604	G36111-0604
04059-100808	G60669-1008	06120-0404	G60615-0404	06232-08	G60612-0808	07208-0606	G36111-0606
04059-100810	G60671-1008	06120-0602	G60615-0206	06232-12	G60612-1212	07208-0608	G36111-0608
04059-101006	G60670-1006	06120-0604	G60615-0406	06235-0402	G60610-0204	07208-0808	G36111-0808
04059-101008	G60670-1008	06120-0606	G60615-0606	06235-0602	G60610-0206	07208-0812	G36111-0812
04059-121012	G60671-1210	06120-0804	G60615-0408	06235-0604	G60610-0406	07208-1012	G36111-1012
04059-121210	G60669-1210	06120-0806	G60615-0608	07201-0402	G36100-0402	07208-1212	G36111-1212
04064-04	G60684-0004	06120-0808	G60615-0808	07201-0404	G36100-0404	07210-0404	G36210-0404
04064-05	G60684-0005	06120-1208	G60615-0812	07201-0406	G36100-0406	07210-0405	G36210-0405
04064-06	G60684-0006	06120-1212	G60615-1212	07201-0502	G36100-0502	07210-0505	G36210-0505
04064-08	G60684-0008	06122-02	G60605-0202	07201-0504	G36100-0504	07210-0605	G36210-0605
04064-10	G60684-0010	06122-04	G60605-0404	07201-0602	G36100-0602	07210-0808	G36210-0808
04064-12	G60684-0012	06122-06	G60605-0606	07201-0604	G36100-0604	07210-1010	G36210-0810
04095-0402	G60652-0402	06122-08	G60605-0808	07201-0606	G36100-0606	07210-1210	G36210-1010
04095-0404	G60652-0404	06122-12	G60605-1212	07201-0608	G36100-0608	07211-0406	G36200-0406
04095-0502	G60652-0502	06123-0402	G60605-0204	07201-0804	G36100-0804	07211-0506	G36200-0506
04095-0504	G60652-0504	06123-0602	G60605-0206	07201-0806	G36100-0806	07211-0606	G36200-0606
04095-0604	G60652-0604	06123-0604	G60605-0406	07201-0808	G36100-0808	07211-0806	G36200-0806
04095-0606	G60652-0606	06123-0804	G60605-0408	07201-0812	G36100-0812	07211-1212	G36200-1212
04095-0608	G60652-0608	06123-0806	G60605-0608	07201-1006	G36100-1006	07212-0406	G36170-0406
04095-0806	G60652-0806	06123-1208	G60605-0812	07201-1008	G36100-1008	07212-0606	G36170-0606
04095-0808	G60652-0808	06124-02	G60635-0202	07201-1012	G36100-1012	07212-1212	G36170-1212
04095-1008	G60652-1008	06124-04	G60635-0404	07201-1208	G36100-1208	07213-0605	G36508-0605
04095-1208	G60652-1208	06124-06	G60635-0606	07201-1212	G36100-1212	07213-0808	G36508-0808
04095-1212	G60652-1212	06124-08	G60635-0808	07202-0404	G36105-0404	07214-0404	G36535-0404
04339-03	G60691-0003	06124-12	G60635-1212	07202-0606	G36105-0606	07214-0505	G36535-0505
04339-04	G60691-0004	06125-02	G60601-0002	07202-0808	G36105-0808	07214-0606	G36535-0606
04339-05	G60691-0005	06125-04	G60601-0004	07202-1212	G36105-1212	07214-0808	G36535-0808
04339-06	G60691-0006	06125-06	G60601-0006	07204-0404	G36195-0404	07214-1010	G36535-1010
04342-02	G60693-0002	06125-08	G60601-0008	07204-0405	G36195-0405	07214-1212	G36535-1212
04342-03	G60693-0003	06125-12	G60601-0012	07204-0406	G36195-0406	07215-0808	G36520-0808
04342-04	G60693-0004	06127-02	G60641-0202	07204-0604	G36195-0604	07215-1010	G36520-1010
04342-05	G60693-0005	06127-04	G60641-0404	07204-0605	G36195-0605	07220-0402	G36106-0402
04342-06	G60693-0006	06127-06	G60641-0606	07204-0606	G36195-0606	07220-0404	G36106-0404
04342-08	G60693-0008	06127-08	G60641-0808	07204-0608	G36195-0608	07220-0602	G36106-0602
04346-0302	G60630-0302	06127-12	G60641-1212	07204-0808	G36195-0808	07220-0606	G36106-0606
04346-0402	G60630-0402	06131-12	G60642-1212	07204-0810	G36195-0810	07220-0808	G36106-0808
04346-0404	G60630-0404	06200-02	G60637-0202	07204-1008	G36195-1008	07220-1212	G36106-1212
04346-0502	G60630-0502	06200-04	G60637-0404	07204-1010	G36195-1010	08060-06	G33050-0006
04346-0604	G60630-0604	06200-06	G60637-0606	07204-1210	G36195-1210	08060-08	G33050-0008
04346-0806	G60630-0806	06200-08	G60637-0808	07204-1212	G36195-1212	08061-06	G33060-0006
04346-1008	G60630-1008	06200-12	G60637-1212	07205-0404	G36165-0404	08061-08	G33060-0008
04348-0202	G60625-0202	06201-02	G60640-0202	07205-0405	G36165-0405	08062-06	G33400-0606
04348-0302	G60625-0302	06201-04	G60640-0404	07205-0406	G36165-0406	08062-08	G33400-0808
04348-0402	G60625-0402	06201-06	G60640-0606	07205-0604	G36165-0604	08066-0612	G33150-0606
04348-0404	G60625-0404	06201-08	G60640-0808	07205-0605	G36165-0605	08066-0614	G33150-0808
04348-0502	G60625-0502	06201-12	G60640-1212	07205-0606	G36165-0606	08068-0604	G33100-0604
04348-0504	G60625-0504	06205-0402	G60637-0204	07205-0608	G36165-0608	08068-0606	G33100-0606
04348-0602	G60625-0602	06205-0604	G60637-0406	07205-0808	G36165-0808	08068-0608	G33100-0608
04348-0604	G60625-0604	06205-0806	G60637-0608	07205-0810	G36165-0810	08068-0806	G33100-0806
04348-0606	G60625-0606	06206-020204	G60640-0204	07205-1008	G36165-1008	08068-0808	G33100-0808
04348-0804	G60625-0804	06206-040402	G60640-0402	07205-1010	G36165-1010	08070-06	G33112-0006
04348-0806	G60625-0806	06206-060604	G60640-0604	07205-1210	G36165-1210	08070-08	G33112-0008
04348-0808	G60625-0808	06206-080806	G60640-0806	07205-1212	G36165-1212	08071-06	G33061-0006
04348-1008	G60625-1008	06206-121208	G60640-1208	07206-0403	G36500-0403	08071-08	G33061-0008
06103-02	G60631-0202	06216-02	G60620-0202	07206-0404	G36500-0404	08078-0604	G33110-0604
06103-04	G60631-0404	06216-04	G60620-0404	07206-0405	G36500-0405	08078-0606	G33110-0606
06103-06	G60631-0606	06216-06	G60620-0606	07206-0504	G36500-0504	08078-0608	G33110-0608
06103-08	G60631-0808	06216-08	G60620-0808	07206-0505	G36500-0505	08078-0806	G33110-0806
06103-12	G60631-1212	06216-12	G60620-1212	07206-0506	G36500-0506	08078-0808	G33110-0808
06104-02	G60632-0202	06228-0204	G60620-0402	07206-0605	G36500-0605	08086-0604	G33151-0604
06104-04	G60632-0404	06228-0402	G60620-0204	07206-0606	G36500-0606	08086-0606	G33151-0606
06104-06	G60632-0606	06228-0406	G60620-0604	07206-0608	G36500-0608	08086-0806	G33151-0806
06104-08	G60632-0808	06228-0604	G60620-0406	07206-0806	G36500-0806	08088-0604	G33030-0604
06104-12	G60632-1212	06228-0608	G60620-0806	07206-0808	G36500-0808	08088-0606	G33030-0606

AIR BRAKE NYLON TUBING
AIR BRAKE COPPER TUBING
AIR BRAKE SURELOK
COMPOSITE AIR BRAKE SURELOK
AIR BRAKE COMPRESSION FITTINGS
AIR BRAKE COUPLINGS FOR RUBBER HOSE
VALVES
BRASS LOCK-ON FIELD ATTACHABLE COUPLINGS
SINGLE BEAD
BARB STEM
INVERTED FLARE
AUTOMOTIVE ADAPTERS
COPPER TUBING INDUSTRIAL COMPRESSION
INDUSTRIAL SURELOK
MINI-BARBED TUBE
POLY INDUSTRIAL COMPRESSION
PIPE ADAPTERS
ADAPTERS SAE FLARE
THREADED SLEEVE
KITS & ASSORTMENTS

Competitive Interchange

AIR BRAKE NYLON TUBING
AIR BRAKE COPPER TUBING
AIR BRAKE SURELOK
COMPOSITE AIR BRAKE SURELOK
AIR BRAKE COMPRESSION FITTINGS
AIR BRAKE COUPLINGS FOR RUBBER HOSE
VALVES
BRASS LOCK-ON FIELD ATTACHABLE COUPLINGS
SINGLE BEAD
BARB STEM
INVERTED FLARE
AUTOMOTIVE ADAPTERS
COPPER TUBING INDUSTRIAL COMPRESSION
INDUSTRIAL SURELOK
MINI-BARBED TUBE
POLY INDUSTRIAL COMPRESSION
PIPE ADAPTERS
ADAPTERS SAE FLARE
THREADED SLEEVE
KITS & ASSORTMENTS

Interchange No.	Gates No.	Interchange No.	Gates No.	Interchange No.	Gates No.	Interchange No.	Gates No.
ANDERSON FIT. - CONT.		ANDERSON FIT. - CONT.		BRASS CRAFT - CONT.		CORONET - CONT.	
08088-0806	G33030-0806	09204-0402	G33720-0402	762AB-10	G32400-1010	368-64	G33100-0604
08088-0808	G33030-0808	09204-0404	G33720-0404	762AB-12	G32400-1212	368-66	G33100-0606
08098-0604	G33111-0604	09204-0502	G33720-0502	762AB-4	G32400-0404	368-68	G33100-0608
08098-0606	G33111-0606	09204-0504	G33720-0504	762AB-6	G32400-0606	368-86	G33100-0806
08098-0608	G33111-0608	09204-0604	G33720-0604	762AB-8	G32400-0808	368-88	G33100-0808
08098-0806	G33111-0806	09204-0606	G33720-0606	764AB-10	G32450-1010	369-8	G33060-0008
08098-0808	G33111-0808	09204-0608	G33720-0608	764AB-4	G32450-0404	370-64	G33111-0604
08701-0302	G37100-0302	09204-0806	G33720-0806	764AB-6	G32450-0606	370-66	G33111-0606
08701-0402	G37100-0402	09204-0808	G33720-0808	764AB-8	G32450-0808	370-68	G33111-0608
08701-0404	G37100-0404	09206-04	G33701-0404	765AB-10	G32404-1010	370-88	G33027-0008
08701-0502	G37100-0502	09206-05	G33701-0505	765AB-4	G32404-0404	377-6	G33112-0006
08701-0504	G37100-0504	09206-06	G33701-0606	765AB-6	G32404-0606	378-64	G33110-0604
08701-0602	G37100-0602	09206-08	G33701-0808	765AB-8	G32404-0808	378-66	G33110-0606
08701-0604	G37100-0604	09210-04	G33730-0404	766AB-10-6	G32150-1006	378-68	G33110-0608
08701-0606	G37100-0606	09210-05	G33730-0505	766AB-10-8	G32150-1008	378-86	G33110-0806
08701-0806	G37100-0806	09210-06	G33730-0606	766AB-4-2	G32150-0402	378-88	G33110-0808
08701-0808	G37100-0808	09210-08	G33730-0808	766AB-4-4	G32150-0404	385-8	G33032-0006
08701-1006	G37100-1006	09210-10	G33730-1010	766AB-6-2	G32150-0602	386-6	G33150-0606
08701-1008	G37100-1008	09234-02	G33715-0202	766AB-6-4	G32150-0604	386-8	G33150-0808
08701-1012	G37100-1012	09234-04	G33715-0404	766AB-6-6	G32150-0606	388-64	G33030-0604
08701-1208	G37100-1208	09234-06	G33715-0606	766AB-8-6	G32150-0806	388-66	G33030-0606
08701-1212	G37100-1212	09234-08	G33715-0808	766AB-8-8	G32150-0808	388-86	G33030-0806
08704-0606	G37195-0606	09235-02	G33710-0202	768AB-10-6	G32100-1006	388-88	G33030-0808
08706-0404	G37500-0404	09235-04	G33710-0404	768AB-10-8	G32100-1008	460-10	G32050-0010
08706-0405	G37500-0405	09235-06	G33710-0606	768AB-12-12	G32100-1212	460-12	G32050-0012
08706-0504	G37500-0504	09235-08	G33710-0808	768AB-12-8	G32100-1208	460-4	G32050-0004
08706-0505	G37500-0505	09306-02	G33832-0202	768AB-4-2	G32100-0402	460-6	G32050-0006
08706-0506	G37500-0506	09307-04	G33832-0404	768AB-4-4	G32100-0404	460-8	G32050-0008
08706-0605	G37500-0605	09308-06	G33832-0606	768AB-4-6	G32100-0406	461-10	G32060-0010
08706-0606	G37500-0606	09309-08	G33832-0808	768AB-6-2	G32100-0602	461-12	G32060-0012
08713-0505	G37508-0505	09346-02	G33805-0202	768AB-6-4	G32100-0604	461-4	G32060-0004
08713-0605	G37508-0605	09347-04	G33805-0404	768AB-6-6	G32100-0606	461-6	G32060-0006
08713-0606	G37508-0606	09348-06	G33805-0606	768AB-6-8	G32100-0608	461-8	G32060-0008
08720-0402	G37106-0402	09348-08	G33805-0808	768AB-8-4	G32100-0804	462-10	G32400-1010
08720-0502	G37106-0502	09404-02	G33801-0002	768AB-8-6	G32100-0806	462-12	G32400-1212
08720-0504	G37106-0504	09404-04	G33801-0004	768AB-8-8	G32100-0808	462-4	G32400-0404
08720-0602	G37106-0602	09404-06	G33801-0006	769AB-10-6	G32104-1006	462-6	G32400-0606
08720-0604	G37106-0604	09404-08	G33801-0008	769AB-10-8	G32104-1008	462-8	G32400-0808
08720-0606	G37106-0606	09420-02	G33830-0002	769AB-4-2	G32104-0402	464-10	G32450-1010
08720-0806	G37106-0806	09420-04	G33830-0004	769AB-4-4	G32104-0404	464-4	G32450-0404
08720-0806	G37106-1008	09420-06	G33830-0006	769AB-4-6	G32104-0406	464-6	G32450-0606
08720-0808	G37106-0808	09442-04	G33831-0004	769AB-6-2	G32104-0602	464-8	G32450-0808
08720-1006	G37106-1006	09460-02	G33850-0202	769AB-6-4	G32104-0604	465-10	G32404-1010
08720-1208	G37106-1208	09460-04	G33850-0404	769AB-6-6	G32104-0606	465-4	G32404-0404
08722-0404	G37504-0404	09508-02	G33650-0202	769AB-6-8	G32104-0608	465-6	G32404-0606
08722-0405	G37504-0405	09508-04	G33650-0404	769AB-8-4	G32104-0804	465-8	G32404-0808
08722-0605	G37504-0605	09508-06	G33650-0606	769AB-8-6	G32104-0806	466-106	G32150-1006
08722-0606	G37504-0606	09514-04	G33655-0404	769AB-8-8	G32104-0808	466-108	G32150-1008
08941-0808	G32602-0808	09514-06	G33655-0606	770AB-10-8	G32154-1008	466-42	G32150-0402
08942-1008	G33610-0810	09515-04	G33656-0404	770AB-4-2	G32154-0402	466-44	G32150-0404
08944-0606	G33620-0606	09515-06	G33656-0606	770AB-4-4	G32154-0404	466-62	G32150-0602
08944-0806	G33620-0806	BRASS CRAFT		770AB-6-2	G32154-0602	466-64	G32150-0604
08944-1006	G33620-1006	360AB-6	G33050-0006	770AB-6-4	G32154-0604	466-66	G32150-0606
08944-1008	G33620-1008	361AB-6	G33060-0006	770AB-6-6	G32154-0606	466-86	G32150-0806
08944-1206	G33620-1206	361ABS-6	G33061-0006	770AB-8-6	G32154-0806	466-88	G32150-0808
08944-1208	G33620-1208	368AB-6-4	G33100-0604	770AB-8-8	G32154-0808	468-106	G32100-1006
08945-0606	G33630-0606	368AB-6-6	G33100-0606	771AB-6-6	G32130-0606	468-108	G32100-1008
08945-0608	G33630-0608	368AB-6-8	G33100-0608	772AB-10-8	G32134-1008	468-1212	G32100-1212
08945-0808	G33630-0808	371AS-6	G33112-0006	772AB-4-2	G32134-0402	468-128	G32100-1208
08947-0606	G33622-0606	376AB-3/4-4	G33030-0604	772AB-4-4	G32134-0404	468-42	G32100-0402
08947-1006	G33622-1006	376AB-3/4-6	G33030-0606	772AB-6-4	G32134-0604	468-44	G32100-0404
08948-0808	G33601-0808	378AB-6-4	G33110-0604	772AB-6-6	G32134-0606	468-46	G32100-0406
08949-0604	G33612-0604	378AB-6-6	G33110-0606	772AB-8-6	G32134-0806	468-62	G32100-0602
08949-0606	G33612-0606	378AB-6-8	G33110-0608	772AB-8-8	G32134-0808	468-64	G32100-0604
08949-0608	G33612-0608	760AB-10	G32050-0010	779AB-10-8	G32102-1008	468-66	G32100-0606
08949-0806	G33612-0806	760AB-12	G32050-0012	779AB-4-2	G32102-0402	468-68	G32100-0608
08949-0808	G33612-0808	760AB-4	G32050-0004	779AB-6-4	G32102-0604	468-84	G32100-0804
08949-1008	G33612-1008	760AB-6	G32050-0006	779AB-6-6	G32102-0606	468-86	G32100-0806
08949-1208	G33705-0402	760AB-8	G32050-0008	779AB-8-6	G32102-0806	468-88	G32100-0808
09201-0402	G33705-0404	761AB-10	G32060-0010	CORONET		468-88	G32104-0808
09201-0404	G33705-0502	761AB-12	G32060-0012	362-6	G33060-0006	469-106	G32104-1006
09201-0504	G33705-0504	761AB-4	G32060-0004	362-8	G33400-0808	469-108	G32104-1008
09201-0604	G33705-0604	761AB-6	G32060-0006	367-6	G33050-0006	469-42	G32104-0402
09201-0606	G33705-0606	761AB-8	G32060-0008	367-8	G33050-0008	469-44	G32104-0404
09201-0806	G33705-0806					469-46	G32104-0406
						469-62	G32104-0602

Competitive Interchange

Interchange No.	Gates No.	Interchange No.	Gates No.	Interchange No.	Gates No.	Interchange No.	Gates No.
CORONET - CONT.		EDELMANN - CONT.		EDELMANN - CONT.		EDELMANN - CONT.	
469-64	G32104-0604	123400	G60693-0004	149680	G60654-0608	222640	G60605-0406
469-66	G32104-0606	123500	G60693-0005	149840	G60654-0804	222660	G60605-0606
469-68	G32104-0608	123600	G60693-0006	149860	G60654-0806	222880	G60605-0808
469-84	G32104-0804	123800	G60693-0008	149880	G60654-0808	224200	G60635-0202
469-86	G32104-0806	124220	G60625-0202	149908	G60654-1008	224400	G60635-0404
470-108	G32154-1008	124320	G60625-0302	149928	G60654-1208	224600	G60635-0606
470-42	G32154-0402	124420	G60625-0402	150420	G60664-0402	227200	G60641-0202
470-44	G32154-0404	124440	G60625-0404	150440	G60664-0404	227400	G60641-0404
470-62	G32154-0602	124520	G60625-0502	150520	G60664-0502	227600	G60641-0606
470-64	G32154-0604	124540	G60625-0504	150640	G60664-0604	228200	G60642-0202
470-66	G32154-0606	124620	G60625-0602	150660	G60664-0606	228400	G60642-0404
470-86	G32154-0806	124640	G60625-0604	150860	G60664-0806	228600	G60642-0606
470-88	G32154-0808	124660	G60625-0606	151320	G60659-0203	301200	G33830-0002
471-66	G32130-0606	124860	G60625-0806	151420	G60659-0204	303400	G33830-0004
472-108	G32134-1008	124880	G60625-0808	151520	G60659-0205	309600	G33830-0006
472-42	G32134-0402	126320	G60630-0302	151640	G60659-0406	331220	G33715-0202
472-44	G32134-0404	126420	G60630-0402	151860	G60659-0606	332440	G33715-0404
472-64	G32134-0604	126520	G60630-0502	151908	G60659-0810	338400	G33832-0404
472-66	G32134-0606	126640	G60630-0604	154420	G60652-0402	341200	G33801-0002
472-86	G32134-0806	126860	G60630-0806	154520	G60652-0502	342400	G33801-0004
472-88	G32134-0808	142300	G60645-0303	154640	G60652-0604	343600	G33801-0006
475-4	G32300-0404	142400	G60645-0404	154860	G60652-0806	348220	G33710-0202
475-6	G32300-0606	142500	G60645-0505	155400	G60648-0404	349440	G33710-0404
475-8	G32300-0808	142600	G60645-0606	155500	G60648-0505	349440	G33710-0808
480-108	G32102-1008	142800	G60645-0808	155600	G60648-0606	376220	G33915-0202
480-42	G32102-0402	142900	G60645-1010	155800	G60648-0808	377440	G33910-0404
480-64	G32102-0604	142920	G60645-1212	155900	G60648-1010	377440	G33915-0404
480-66	G32102-0606	144300	G60669-0303	200200	G60637-0202	427420	G33705-0402
480-86	G32102-0806	144400	G60669-0404	200400	G60637-0404	428400	G33701-0404
DORMAN		144500	G60669-0504	200600	G60637-0606	429520	G33705-0502
490-601	G32050-0004	144500	G60669-0505	200800	G60637-0808	430500	G33701-0505
490-602	G32050-0006	144600	G60669-0606	201200	G60640-0202	457640	G33705-0604
490-603	G32050-0008	144800	G60669-0808	201400	G60640-0404	458600	G33701-0606
490-611	G32060-0004	144900	G60669-1010	201600	G60640-0606	469400	G33650-0404
490-612	G32060-0006	145320	G60657-0302	201800	G60640-0808	469600	G33650-0606
490-613	G32060-0008	145420	G60657-0402	203200	G60631-0202	470400	G33655-0404
490-631	G32400-0404	145520	G60657-0502	203400	G60631-0404	471400	G33656-0404
490-632	G32400-0606	145640	G60657-0604	203600	G60631-0606	491420	G33720-0402
490-633	G32400-0808	145860	G60657-0806	203800	G60631-0808	492400	G33730-0404
490-641	G32404-0404	145908	G60657-1008	204200	G60632-0202	493520	G33720-0502
490-642	G32404-0606	145928	G60657-1208	204400	G60632-0404	494500	G33730-0505
490-643	G32404-0808	146320	G60660-0302	204600	G60632-0606	495640	G33720-0604
490-651	G32100-0402	146420	G60660-0402	204800	G60632-0808	496600	G33730-0606
490-652	G32100-0404	146440	G60660-0404	208200	G60600-0002	501420	G33905-0402
490-653	G32100-0406	146520	G60660-0502	208400	G60600-0004	502520	G33905-0502
490-654	G32100-0602	146540	G60660-0504	208600	G60600-0006	505420	G33910-0402
490-655	G32100-0606	146620	G60660-0602	209200	G60601-0002	506520	G33910-0502
490-656	G32100-0608	146640	G60660-0604	209400	G60601-0004	510420	G33945-0402
490-657	G32100-0806	146660	G60660-0606	209600	G60601-0006	511520	G33945-0502
490-658	G32100-0808	146680	G60660-0608	209800	G60601-0008	513420	G33940-0402
490-661	G32104-0402	146860	G60660-0806	209920	G60601-0012	514520	G33940-0502
490-662	G32104-0404	146880	G60660-0808	210420	G60614-0402	520400	G33901-0404
490-663	G32104-0406	146908	G60660-1008	210620	G60614-0602	521500	G33901-0505
490-664	G32104-0604	148320	G60650-0302	210640	G60614-0604	548220	G33920-0202
490-665	G32104-0606	148420	G60650-0402	210820	G60614-0802	549440	G33920-0404
490-666	G32104-0608	148440	G60650-0404	210840	G60614-0804	721340	G36500-0403
490-667	G32104-0806	148520	G60650-0502	210860	G60614-0806	721440	G36500-0404
490-668	G32104-0808	148540	G60650-0504	210928	G60614-1208	721450	G36500-0504
490-671	G32154-0404	148620	G60650-0602	216200	G60620-0202	721540	G36500-0405
490-672	G32154-0604	148640	G60650-0604	216400	G60620-0404	721560	G36500-0605
490-673	G32154-0606	148660	G60650-0606	216420	G60620-0402	721650	G36500-0506
490-674	G32154-0806	148680	G60650-0608	216600	G60620-0606	724560	G36508-0605
490-677	G33050-0006	148840	G60650-0804	216800	G60620-0808	741540	G36210-0405
490-681	G33050-0006	148860	G60650-0806	219420	G60631-0402	741660	G36200-0606
490-685	G33060-0006	148880	G60650-0808	219620	G60631-0602	742440	G36195-0404
490-691	G33110-0606	148908	G60650-1008	219640	G60631-0604	742540	G36195-0405
EDELMANN		148928	G60650-1208	219860	G60631-0806	742660	G36195-0606
120300	G60691-0003	149320	G60654-0302	220220	G60615-0202	744250	G36100-0502
120400	G60691-0004	149420	G60654-0402	220420	G60615-0204	744450	G36100-0504
120500	G60691-0005	149440	G60654-0404	220440	G60615-0404	744660	G36100-0606
120600	G60691-0006	149460	G60654-0406	220640	G60615-0406	744880	G36100-0808
123200	G60693-0002	149520	G60654-0502	220860	G60615-0606	750400	G36535-0404
123300	G60693-0003	149540	G60654-0504	220660	G60615-0608	750500	G36535-0505
		149620	G60654-0602	222220	G60605-0202	750600	G36535-0606
		149640	G60654-0604	222440	G60605-0204	750800	G36535-0808
		149660	G60654-0606			911440	G32300-0404

AIR BRAKE NYLON TUBING
AIR BRAKE COPPER TUBING
AIR BRAKE SURELOK
COMPOSITE AIR BRAKE SURELOK
AIR BRAKE COMPRESSION FITTINGS
AIR BRAKE COUPLINGS FOR RUBBER HOSE
VALVES
BRASS LOCK-ON FIELD ATTACHABLE COUPLINGS
SINGLE BEAD
BARB STEM
INVERTED FLARE
AUTOMOTIVE ADAPTERS
COPPER TUBING INDUSTRIAL COMPRESSION
INDUSTRIAL SURELOK
MINI-BARBED TUBE
POLY INDUSTRIAL COMPRESSION
PIPE ADAPTERS
ADAPTERS SAE FLARE
THREADED SLEEVE
KITS & ASSORTMENTS

Competitive Interchange

AIR BRAKE NYLON TUBING
AIR BRAKE COPPER TUBING
AIR BRAKE SURELOK
COMPOSITE AIR BRAKE SURELOK
AIR BRAKE COMPRESSION FITTINGS
AIR BRAKE COUPLINGS FOR RUBBER HOSE
VALVES
BRASS LOCK-ON FIELD ATTACHABLE COUPLINGS
SINGLE BEAD
BARB STEM
INVERTED FLARE
AUTOMOTIVE ADAPTERS
COPPER TUBING INDUSTRIAL COMPRESSION
INDUSTRIAL SURELOK
MINI-BARBED TUBE
POLY INDUSTRIAL COMPRESSION
PIPE ADAPTERS
ADAPTERS SAE FLARE
THREADED SLEEVE
KITS & ASSORTMENTS

Interchange No.	Gates No.	Interchange No.	Gates No.	Interchange No.	Gates No.	Interchange No.	Gates No.
EDELMANN - CONT.		EDELMANN - CONT.		EVERCO - CONT.		FAIRVIEW - CONT.	
911460.....	G32300-0606	917242.....	G32134-0402	6662F.....	G32400-0808	1466-10C.....	G32150-1006
911480.....	G32300-0808	917244.....	G32134-0404	6662G.....	G32400-1010	1466-10D.....	G32150-1008
916040.....	G32050-0004	917264.....	G32134-0604	6662H.....	G32400-1212	1466-4A.....	G32150-0402
916060.....	G32050-0006	917266.....	G32134-0606	6664C.....	G32450-0404	1466-4B.....	G32150-0404
916080.....	G32050-0008	917286.....	G32134-0806	6664E.....	G32450-0606	1466-6A.....	G32150-0602
916090.....	G32050-0010	917288.....	G32134-0808	6664F.....	G32450-0808	1466-6B.....	G32150-0604
916092.....	G32050-0012	917908.....	G32102-1008	6664G.....	G32450-1010	1466-6C.....	G32150-0606
916140.....	G32060-0004	917942.....	G32102-0402	6665C.....	G32404-0404	1466-8C.....	G32150-0806
916160.....	G32060-0006	917964.....	G32102-0604	6665E.....	G32404-0606	1466-8D.....	G32150-0808
916180.....	G32060-0008	917966.....	G32102-0606	6665F.....	G32404-0808	1468-10C.....	G32100-1006
916190.....	G32060-0010	917986.....	G32102-0806	6665G.....	G32404-1010	1468-10D.....	G32100-1008
916192.....	G32060-0012	926060.....	G33050-0006	6666C.....	G32150-0402	1468-12D.....	G32100-1208
916240.....	G32400-0404	926080.....	G33050-0008	6666E.....	G32150-0604	1468-12E.....	G32100-1212
916260.....	G32400-0606	926160.....	G33060-0006	6666EE.....	G32150-0606	1468-4B.....	G32100-0402
916280.....	G32400-0808	926180.....	G33060-0008	6666F.....	G32150-0806	1468-4B.....	G32100-0404
916290.....	G32400-1010	926260.....	G33400-0606	6666G.....	G32150-1006	1468-4C.....	G32100-0406
916292.....	G32400-1212	926280.....	G33400-0808	6667C.....	G32102-0402	1468-6A.....	G32100-0602
916340.....	G32040-0004	926660.....	G33150-0606	6667E.....	G32102-0604	1468-6B.....	G32100-0604
916360.....	G32040-0006	926680.....	G33150-0808	6667EEE.....	G32102-0606	1468-6C.....	G32100-0606
916380.....	G32040-0008	926864.....	G33100-0604	6667FF.....	G32102-0806	1468-6D.....	G32100-0608
916390.....	G32040-0010	926886.....	G33100-0606	6668C.....	G32100-0402	1468-8B.....	G32100-0804
916392.....	G32040-0012	926888.....	G33100-0608	6668CC.....	G32100-0404	1468-8C.....	G32100-0806
916440.....	G32450-0404	926886.....	G33100-0806	6668CCC.....	G32100-0406	1468-8D.....	G32100-0808
916460.....	G32450-0606	926888.....	G33100-0808	6668E.....	G32100-0602	1469-10C.....	G32104-1006
916480.....	G32450-0808	927764.....	G33030-0604	6668EE.....	G32100-0604	1469-10D.....	G32104-1008
916490.....	G32450-1010	927766.....	G33030-0606	6668EEE.....	G32100-0606	1469-4A.....	G32104-0402
916540.....	G32404-0404	927786.....	G33030-0806	6668EEEE.....	G32100-0608	1469-4B.....	G32104-0404
916560.....	G32404-0606	927788.....	G33030-0808	6668F.....	G32100-0804	1469-4C.....	G32104-0406
916580.....	G32404-0808	927864.....	G33151-0604	6668FF.....	G32100-0806	1469-6A.....	G32104-0602
916590.....	G32404-1010	927866.....	G33151-0606	6668FFF.....	G32100-0808	1469-6B.....	G32104-0604
916606.....	G32150-1006	928064.....	G33111-0604	6668G.....	G32100-1006	1469-6C.....	G32104-0606
916608.....	G32150-1008	928066.....	G33111-0606	6668GG.....	G32100-1008	1469-6D.....	G32104-0608
916642.....	G32150-0402	928068.....	G33111-0608	6668H.....	G32100-1208	1469-8B.....	G32104-0804
916644.....	G32150-0404	928086.....	G33111-0806	6669C.....	G32104-0402	1469-8C.....	G32104-0806
916662.....	G32150-0602	928088.....	G33111-0808	6669CC.....	G32104-0404	1469-8D.....	G32104-0808
916664.....	G32150-0604	930040.....	G33021-0004	6669CCC.....	G32104-0406	1470-10D.....	G32154-1008
916666.....	G32150-0606	930280.....	G33027-0008	6669E.....	G32104-0604	1470-4A.....	G32154-0402
916686.....	G32150-0806	935000.....	G33032-0006	6669EE.....	G32104-0606	1470-4B.....	G32154-0404
916688.....	G32150-0808	936060.....	G33112-0006	6669EEE.....	G32104-0602	1470-6A.....	G32154-0602
916806.....	G32100-1006	936080.....	G33112-0008	6669F.....	G32104-0806	1470-6B.....	G32154-0604
916808.....	G32100-1008	936160.....	G33061-0006	6669FF.....	G32104-0808	1470-6C.....	G32154-0606
916828.....	G32100-1208	936180.....	G33061-0008	6669FFF.....	G32104-0804	1470-8C.....	G32154-0806
916842.....	G32100-0402	936864.....	G33110-0604	6669G.....	G32104-1008	1470-8D.....	G32154-0808
916844.....	G32100-0404	936866.....	G33110-0606	6669GG.....	G32104-1006	1471-6C.....	G32130-0606
916846.....	G32100-0406	936868.....	G33110-0608	6670C.....	G32154-0402	1472-10D.....	G32134-1008
916862.....	G32100-0602	936886.....	G33110-0806	6670EE.....	G32154-0606	1472-4A.....	G32134-0402
916864.....	G32100-0604	936888.....	G33110-0808	6672C.....	G32134-0402	1472-4B.....	G32134-0404
916866.....	G32100-0606	PBC-516.....	G30050-1508	6672E.....	G32134-0604	1472-6A.....	G32134-0602
916868.....	G32100-0608	PBC-641.....	G30050-1208	6672F.....	G32134-0806	1472-6B.....	G32134-0604
916884.....	G32100-0804			6672G.....	G32134-1008	1472-6C.....	G32134-0606
916886.....	G32100-0806					1472-8C.....	G32134-0806
916888.....	G32100-0808					1472-8D.....	G32134-0808
916892.....	G32100-1212					1474-10D.....	G32102-1008
916906.....	G32104-1006					1474-4A.....	G32102-0402
916908.....	G32104-1008					1474-6B.....	G32102-0604
916928.....	G32104-1208					1474-6C.....	G32102-0606
916942.....	G32104-0402					1474-8C.....	G32102-0806
916944.....	G32104-0404					1474-8D.....	G32102-0808
916946.....	G32104-0406					1477-4.....	G32300-0404
916962.....	G32104-0602					1477-6.....	G32300-0606
916964.....	G32104-0604					1477-8.....	G32300-0808
916966.....	G32104-0606					1485-10-REEL.....	H30000-10
916968.....	G32104-0608					1485-12-REEL.....	H30000-12
916984.....	G32104-0804					1485-2-REEL.....	H30000-02
916986.....	G32104-0806					1485-4-REEL.....	H30000-04
916988.....	G32104-0808					1485-5-REEL.....	H30000-05
917008.....	G32154-1008					1485-6-REEL.....	H30000-06
917042.....	G32154-0402					1485-8-REEL.....	H30000-08
917044.....	G32154-0404					1490-6.....	G33050-0006
917062.....	G32154-0602					1490-8.....	G33050-0008
917064.....	G32154-0604					1491-6.....	G33060-0006
917066.....	G32154-0606					1491-8.....	G33060-0008
917086.....	G32154-0806					1492-6B.....	G33100-0604
917088.....	G32154-0808					1492-6C.....	G33100-0606
917166.....	G32130-0606					1492-6D.....	G33100-0608
917208.....	G32134-1008					1492-6S.....	G33400-0606

Competitive Interchange

Interchange No.	Gates No.	Interchange No.	Gates No.	Interchange No.	Gates No.	Interchange No.	Gates No.
FAIRVIEW - CONT.		FLARE - CONT.		HEBCO - CONT.		HEBCO - CONT.	
1492-8C.....	G33100-0806	NY272-6-4.....	G32134-0604	451031-500.....	H30000-06	S765AB-6.....	G32404-0808
1492-8D.....	G33100-0808	NY272-6-6.....	G32134-0606	451031B.....	H30062-06	S766AB-10-6.....	G32150-1006
1492-8S.....	G33400-0808	NY272-8-6.....	G32134-0806	451031G.....	H30042-06	S766AB-10-8.....	G32150-1008
1492SW-6.....	G33150-0606	NY272-8-8.....	G32134-0808	451031ING.....	H30082-06	S766AB-4-2.....	G32150-0402
1492-SW8.....	G33150-0808	NY279-10-8.....	G32102-1008	451031R.....	H30052-06	S766AB-4-4.....	G32150-0404
1493-6B.....	G33110-0604	NY279-4-2.....	G32102-0402	451031Y.....	H30072-06	S766AB-6-2.....	G32150-0602
1493-6C.....	G33110-0606	NY279-6-4.....	G32102-0604	451032-500.....	H30000-08	S766AB-6-4.....	G32150-0604
1493-6D.....	G33110-0608	NY279-6-6.....	G32102-0606	451032B.....	H30062-08	S766AB-6-6.....	G32150-0606
1493-8C.....	G33110-0806	NY279-8-6.....	G32102-0806	451032G.....	H30042-08	S766AB-8-6.....	G32150-0806
1493-8D.....	G33110-0808	NY279-8-8.....	G32102-0808	451032NG.....	H30082-08	S766AB-8-8.....	G32150-0808
1494-6N.....	G33061-0006	NY60-10.....	G32050-0010	451032R.....	H30052-08	S768AB-10-6.....	G32100-1006
1494-6S.....	G33112-0006	NY60-12.....	G32050-0012	451032Y.....	H30072-08	S768AB-10-8.....	G32100-1008
1494-8N.....	G33061-0008	NY60-4.....	G32050-0004	451033-250.....	H30000-10	S768AB-12-12.....	G32100-1212
1494-8S.....	G33112-0008	NY60-6.....	G32050-0006	451033B.....	H30063-10	S768AB-12-8.....	G32100-1208
14DV-60B.....	G33021-0004	NY60-8.....	G32050-0008	451033G.....	H30043-10	S768AB-4-2.....	G32100-0402
4134-6B.....	G33030-0604	NY61-10.....	G32060-0010	451033NG.....	H30083-10	S768AB-4-4.....	G32100-0404
4134-6C.....	G33030-0606	NY61-12.....	G32060-0012	451033R.....	H30053-10	S768AB-4-6.....	G32100-0406
4134-8C.....	G33030-0806	NY61-4.....	G32060-0004	451033Y.....	H30073-10	S768AB-6-2.....	G32100-0602
B1492-6B.....	G33111-0604	NY61-6.....	G32060-0006	451034-250.....	H30000-12	S768AB-6-4.....	G32100-0604
B1492-6C.....	G33111-0606	NY61-8.....	G32060-0008	451034B.....	H30063-12	S768AB-6-6.....	G32100-0606
B1492-6D.....	G33111-0608	NY62-10.....	G32400-1010	451034G.....	H30043-12	S768AB-6-8.....	G32100-0608
B1492-8C.....	G33111-0806	NY62-12.....	G32400-1212	451034R.....	H30053-12	S768AB-8-4.....	G32100-0804
B1492-8D.....	G33111-0808	NY62-4.....	G32400-0404	451054-500.....	H30000-05	S768AB-8-6.....	G32100-0806
CV1-C.....	G33027-0006	NY62-6.....	G32400-0606	S360AB-6.....	G33050-0006	S768AB-8-8.....	G32100-0808
CV1-D.....	G33027-0008	NY62-8.....	G32400-0808	S360AB-8.....	G33050-0008	S769AB-10-6.....	G32104-1006
GH SEAL.....	G33032-0006	NY66-10-6.....	G32150-1006	S361AB-6.....	G33060-0006	S769AB-10-8.....	G32104-1008
FLARE		NY66-10-8.....	G32150-1008	S361AB-8.....	G33060-0008	S769AB-4-2.....	G32104-0402
2687.....	G33030-0604	NY66-4-2.....	G32150-0402	S361ABS-6.....	G33061-0006	S769AB-4-4.....	G32104-0404
3610.....	G33050-0006	NY66-4-4.....	G32150-0404	S361ABS-8.....	G33061-0008	S769AB-4-6.....	G32104-0406
3613.....	G33061-0006	NY66-6-2.....	G32150-0602	S362RB-6.....	G33400-0606	S769AB-6-2.....	G32104-0602
3624.....	G33060-0006	NY66-6-4.....	G32150-0604	S362RB-8.....	G33400-0808	S769AB-6-4.....	G32104-0604
13630.....	G33032-0006	NY66-6-6.....	G32150-0606	S366RBSV-634.....	G33150-0606	S769AB-6-6.....	G32104-0606
16678.....	G33400-0606	NY66-8-6.....	G32150-0806	S366RBSV-878.....	G33150-0808	S769AB-6-8.....	G32104-0608
33801.....	G33050-0008	NY66-8-8.....	G32150-0808	S368AB-6-4.....	G33100-0604	S769AB-8-4.....	G32104-0804
33802.....	G33060-0008	NY68-10-6.....	G32100-1006	S368AB-6-4-1.....	G33111-0604	S769AB-8-6.....	G32104-0806
33803.....	G33061-0008	NY68-10-8.....	G32100-1008	S368AB-6-6.....	G33100-0606	S769AB-8-8.....	G32104-0808
33805.....	G33030-0606	NY68-12-12.....	G32100-1212	S368AB-6-6-1.....	G33111-0606	S770AB-10-8.....	G32154-1008
33806.....	G33030-0806	NY68-12-8.....	G32100-1208	S368AB-6-8.....	G33100-0608	S770AB-4-2.....	G32154-0402
33887.....	G33400-0808	NY68-4-2.....	G32100-0402	S368AB-6-8-1.....	G33111-0608	S770AB-4-4.....	G32154-0404
NBH62-4.....	G32300-0404	NY68-4-4.....	G32100-0404	S368AB-8-6.....	G33100-0806	S770AB-6-2.....	G32154-0602
NBH62-6.....	G32300-0606	NY68-4-6.....	G32100-0406	S368AB-8-6-1.....	G33111-0806	S770AB-6-4.....	G32154-0604
NBH62-8.....	G32300-0808	NY68-6-2.....	G32100-0602	S368AB-8-8.....	G33100-0808	S770AB-6-6.....	G32154-0606
NY264-10.....	G32450-1010	NY68-6-4.....	G32100-0604	S368AB-8-8-1.....	G33111-0808	S770AB-8-6.....	G32154-0806
NY264-4.....	G32450-0404	NY68-6-6.....	G32100-0606	S371AS-6.....	G33112-0006	S770AB-8-8.....	G32154-0808
NY264-6.....	G32450-0606	NY68-6-8.....	G32100-0608	S371AS-8.....	G33112-0008	S772AB-10-8.....	G32134-1008
NY264-8.....	G32450-0808	NY68-8-4.....	G32100-0804	S376AB-3/4-4.....	G33030-0604	S772AB-4-2.....	G32134-0402
NY265-10.....	G32404-1010	NY68-8-6.....	G32100-0806	S376AB-3/4-6.....	G33030-0606	S772AB-4-4.....	G32134-0404
NY265-4.....	G32404-0404	NY68-8-8.....	G32100-0808	S376AB-3/4-8.....	G33030-0808	S772AB-6-2.....	G32134-0602
NY265-6.....	G32404-0606	PT-10B.....	H30000-10	S376AB-7/8-6.....	G33030-0806	S772AB-6-4.....	G32134-0604
NY265-8.....	G32404-0808	PT-12B.....	H30000-12	S378AB-6-4.....	G33110-0604	S772AB-6-6.....	G32134-0606
NY269-10-6.....	G32104-1006	PT-2A.....	H30000-02	S378AB-6-6.....	G33110-0606	S772AB-8-6.....	G32134-0806
NY269-10-8.....	G32104-1008	PT-4A.....	H30000-04	S378AB-8-6.....	G33110-0806	S772AB-8-8.....	G32134-0808
NY269-4-2.....	G32104-0402	PT-5A.....	H30000-05	S378AB-8-8.....	G33110-0808	S774AB-4.....	G32300-0404
NY269-4-4.....	G32104-0404	PT-6B.....	H30000-06	S761AB-10.....	G32060-0010	S774AB-6.....	G32300-0606
NY269-4-6.....	G32104-0406	PT-8B.....	H30000-08	S761AB-12.....	G32060-0012	S774AB-8.....	G32300-0808
NY269-6-2.....	G32104-0602	HEBCO		S761AB-4.....	G32060-0004	S779AB-10-8.....	G32102-1008
NY269-6-4.....	G32104-0604	401008.....	G33027-0006	S761AB-6.....	G32060-0006	S779AB-4-2.....	G32102-0402
NY269-6-6.....	G32104-0606	401009.....	G33027-0008	S761AB-8.....	G32060-0008	S779AB-6-4.....	G32102-0604
NY269-6-8.....	G32104-0608	401047.....	G33021-0004	S762AB-10.....	G32400-1010	S779AB-6-6.....	G32102-0606
NY269-8-4.....	G32104-0804	441749.....	G33032-0006	S762AB-12.....	G32400-1212	S779AB-8-6.....	G32102-0806
NY269-8-6.....	G32104-0806	451029.....	H30002-02	S762AB-4.....	G32400-0404	S779AB-8-8.....	G32102-0808
NY269-8-8.....	G32104-0808	451030.....	H30002-04	S762AB-6.....	G32400-0606	MID-AMERICA	
NY270-10-8.....	G32154-1008	451031.....	H30002-06	S762AB-8.....	G32400-0808	100F-12.....	G60637-1212
NY270-4-2.....	G32154-0402	451032.....	H30002-08	S763AB-10.....	G32050-0010	100F-2.....	G60637-0202
NY270-4-4.....	G32154-0404	451033.....	H30003-10	S763AB-12.....	G32050-0012	100F-4.....	G60637-0404
NY270-6-2.....	G32154-0602	451034.....	H30003-12	S763AB-4.....	G32050-0004	100F-6.....	G60637-0606
NY270-6-4.....	G32154-0604	451054.....	H30002-05	S763AB-6.....	G32050-0006	100F-8.....	G60637-0808
NY270-6-6.....	G32130-0606	451029-2000.....	H30000-02	S763AB-8.....	G32050-0008	100FR-42.....	G60637-0204
NY270-6-6.....	G32154-0606	451030-1000.....	H30000-04	S764AB-10.....	G32450-1010	100FR-64.....	G60637-0406
NY270-8-6.....	G32154-0806	451030B.....	H30062-04	S764AB-4.....	G32450-0404	100FR-86.....	G60637-0608
NY270-8-8.....	G32154-0808	451030G.....	H30042-04	S764AB-6.....	G32450-0606	1010SAE.....	G33730-1010
NY272-10-8.....	G32134-1008	451030NG.....	H30082-04	S764AB-8.....	G32450-0808	101F-12.....	G60640-1212
NY272-4-2.....	G32134-0402	451030R.....	H30052-04	S765AB-10.....	G32404-1010	101F-2.....	G60640-0202
NY272-4-4.....	G32134-0404	451030Y.....	H30072-04	S765AB-4.....	G32404-0404		
				S765AB-6.....	G32404-0606		

AIR BRAKE NYLON TUBING
AIR BRAKE COPPER TUBING
AIR BRAKE SURELOK
COMPOSITE AIR BRAKE SURELOK
AIR BRAKE COMPRESSION FITTINGS
AIR BRAKE COUPLINGS FOR RUBBER HOSE
VALVES
BRASS LOCK-ON FIELD ATTACHABLE COUPLINGS
SINGLE BEAD
BARB STEM
INVERTED FLARE
AUTOMOTIVE ADAPTERS
COPPER TUBING INDUSTRIAL COMPRESSION
INDUSTRIAL SURELOK
MINI-BARBED TUBE
POLY INDUSTRIAL COMPRESSION
PIPE ADAPTERS
ADAPTERS SAE FLARE
THREADED SLEEVE
KITS & ASSORTMENTS

Competitive Interchange

AIR BRAKE NYLON TUBING
AIR BRAKE COPPER TUBING
AIR BRAKE SURELOK
COMPOSITE AIR BRAKE SURELOK
AIR BRAKE COMPRESSION FITTINGS
AIR BRAKE COUPLINGS FOR RUBBER HOSE
VALVES
BRASS LOCK-ON FIELD ATTACHABLE COUPLINGS
SINGLE BEAD
BARB STEM
INVERTED FLARE
AUTOMOTIVE ADAPTERS
COPPER TUBING INDUSTRIAL COMPRESSION
INDUSTRIAL SURELOK
MINI-BARBED TUBE
POLY INDUSTRIAL COMPRESSION
PIPE ADAPTERS
ADAPTERS SAE FLARE
THREADED SLEEVE
KITS & ASSORTMENTS

Interchange No.	Gates No.	Interchange No.	Gates No.	Interchange No.	Gates No.	Interchange No.	Gates No.
MID-AMERICA - CONT.		MID-AMERICA - CONT.		MID-AMERICA - CONT.		MID-AMERICA - CONT.	
101F-4	G60640-0404	124-8	G60635-0808	29IMES-45	G37504-0405	29PO4-66	G36111-0606
101F-6	G60640-0606	127-12	G60641-1212	29IMES-65	G37504-0605	29PO4-68	G36111-0608
101F-8	G60640-0808	127-2	G60641-0202	29IMES-66	G37504-0606	29PO4-812	G36111-0812
101FR-12128	G60640-1208	127-4	G60641-0404	29PO10-1010	G36520-1010	29PO4-88	G36111-0808
101FR-224	G60640-0204	127-6	G60641-0606	29PO10-88	G36520-0808	29PO5-1010	G36210-0810
101FR-442	G60640-0402	127-8	G60641-0808	29PO1-1012	G36100-1012	29PO5-1210	G36210-1010
101FR-664	G60640-0604	128-24	G60620-0402	29PO1-106	G36100-1006	29PO5-44	G36210-0404
101FR-886	G60640-0806	128-42	G60620-0204	29PO1-108	G36100-1008	29PO5-45	G36210-0405
103-12	G60631-1212	128-46	G60620-0604	29PO11-1010	G36165-1010	29PO5-55	G36210-0505
103-2	G60631-0202	128-64	G60620-0406	29PO11-108	G36165-1008	29PO5-88	G36210-0808
103-4	G60631-0404	128-68	G60620-0806	29PO11-1210	G36165-1210	29PO6-1212	G36200-1212
103-6	G60631-0606	128-86	G60620-0608	29PO11-1212	G36165-1212	29PO6-46	G36200-0406
103-8	G60631-0808	130-2	G60610-0202	29PO1-1212	G36100-1212	29PO6-56	G36200-0506
104-12	G60632-1212	130F-4	G60610-0404	29PO1-128	G36100-1208	29PO6-66	G36200-0606
104-2	G60632-0202	130F-6	G60610-0606	29PO11-44	G36165-0404	29PO6-86	G36200-0806
104-4	G60632-0404	130F-8	G60610-0808	29PO11-45	G36165-0405	29PO7-1212	G36170-1212
104-6	G60632-0606	130R-42	G60610-0204	29PO11-46	G36165-0406	29PO7-46	G36170-0406
104-8	G60632-0808	130R-62	G60610-0206	29PO11-64	G36165-0604	29PO7-66	G36170-0606
104SAE	G33940-0402	130R-64	G60610-0406	29PO11-65	G36165-0605	29PO8-10	G36535-1010
106SAE	G33940-0502	131-12	G60642-1212	29PO11-66	G36165-0606	29PO8-12	G36535-1212
108-12	G60600-0012	131F-2	G60642-0202	29PO11-68	G36165-0608	29PO8-4	G36535-0404
108-2	G60600-0002	131F-4	G60642-0404	29PO11-810	G36165-0810	29PO8-5	G36535-0505
108-4	G60600-0004	131F-6	G60642-0606	29PO11-88	G36165-0808	29PO8-6	G36535-0606
108-6	G60600-0006	131F-8	G60642-0808	29PO13-65	G36508-0605	29PO8-8	G36535-0808
108-8	G60600-0008	132F-12	G60612-1212	29PO13-88	G36508-0808	29PO9-1212	G36105-1212
108SAE	G33940-0604	132F-2	G60612-0202	29PO1-42	G36100-0402	29PO9-44	G36105-0404
110-126	G60614-1206	132F-4	G60612-0404	29PO1-44	G36100-0404	29PO9-66	G36105-0606
110-128	G60614-1208	132F-6	G60612-0606	29PO1-46	G36100-0406	29PO9-88	G36105-0808
110-42	G60614-0402	132F-8	G60612-0808	29PO1-52	G36100-0502	29POE-1212	G36106-1212
110-62	G60614-0602	1390-64	G33030-0604	29PO1-54	G36100-0504	29POE-42	G36106-0402
110-64	G60614-0604	1390-66	G33030-0606	29PO16-1010	G36500-1010	29POE-44	G36106-0404
110-82	G60614-0802	1390-86	G33030-0806	29PO1-62	G36100-0602	29POE-62	G36106-0602
110-84	G60614-0804	1390-88	G33030-0808	29PO1-64	G36100-0604	29POE-66	G36106-0606
110-86	G60614-0806	200C-4	G33655-0404	29PO16-43	G36500-0403	29POE-88	G36106-0808
113-632	G60608-0606	200C-6	G33655-0606	29PO16-44	G36500-0404	29SAE	G33720-0502
116F-12	G60620-1212	200P	G33830-0002	29PO16-45	G36500-0405	29SB-1012	G37100-1012
116F-2	G60620-0202	201P	G33830-0004	29PO16-54	G36500-0504	29SB-1060	G37100-1006
116F-4	G60620-0404	202P	G33830-0006	29PO16-55	G36500-0505	29SB-108	G37100-1008
116F-6	G60620-0606	203SAE	G33945-0502	29PO16-56	G36500-0506	29SB-1212	G37100-1212
116F-8	G60620-0808	210C-2	G33650-0202	29PO1-66	G36100-0606	29SB-128	G37100-1208
119-128	G60631-1208	210C-4	G33650-0404	29PO16-65	G36500-0605	29SB-32	G37100-0302
119-42	G60631-0402	210C-6	G33650-0606	29PO16-66	G36500-0606	29SB-42	G37100-0402
119-62	G60631-0602	215C-4	G33656-0404	29PO16-68	G36500-0608	29SB-44	G37100-0404
119-64	G60631-0604	215C-6	G33656-0606	29PO1-68	G36100-0608	29SB-52	G37100-0502
119-86	G60631-0806	227C	G33705-0404	29PO16-86	G36500-0806	29SB-54	G37100-0504
120-1212	G60615-1212	227SAE	G33720-0404	29PO16-88	G36500-0808	29SB-62	G37100-0602
120-128	G60615-0812	229C	G33705-0504	29PO1-812	G36100-0812	29SB-64	G37100-0604
120-22	G60615-0202	229SAE	G33720-0504	29PO1-84	G36100-0804	29SB-66	G37100-0606
120-42	G60615-0204	23328X8	G60608-0808	29PO1-86	G36100-0806	29SB-86	G37100-0806
120-44	G60615-0404	27C	G33705-0402	29PO1-88	G36100-0808	29SB-88	G37100-0808
120-62	G60615-0206	27SAE	G33720-0402	29PO2-108	G36110-1008	29SSB-66	G37195-0606
120-64	G60615-0406	28C	G33701-0404	29PO2-1212	G36110-1212	303SAE	G33945-0604
120-66	G60615-0606	28SAE	G33730-0404	29PO2-44	G36110-0404	30C	G33701-0505
120-84	G60615-0408	29C	G33705-0502	29PO2-54	G36110-0504	30SAE	G33730-0505
120-86	G60615-0608	29ESB-106	G37106-1006	29PO2-66	G36110-0606	31P	G33715-0202
120-88	G60615-0808	29ESB-108	G37106-1008	29PO2-86	G36110-0806	32P	G33715-0404
121S-12	G60601-0012	29ESB-128	G37106-1208	29PO2-88	G36110-0808	39-10	G60644-0010
121S-2	G60601-0002	29ESB-42	G37106-0402	29PO3-1010	G36195-1010	39-12	G60644-0012
121S-4	G60601-0004	29ESB-52	G37106-0502	29PO3-108	G36195-1008	39-3	G60644-0003
121S-6	G60601-0006	29ESB-54	G37106-0504	29PO3-1210	G36195-1210	39-4	G60644-0004
121S-8	G60601-0008	29ESB-62	G37106-0602	29PO3-1212	G36195-1212	39-5	G60644-0005
122-12	G60605-1212	29ESB-64	G37106-0604	29PO3-44	G36195-0404	39-6	G60644-0006
122-2	G60605-0202	29ESB-66	G37106-0606	29PO3-45	G36195-0405	39-8	G60644-0008
122-4	G60605-0404	29ESB-86	G37106-0806	29PO3-46	G36195-0406	39IF-3	G60691-0003
122-6	G60605-0606	29ESB-88	G37106-0808	29PO3-64	G36195-0604	39IF-4	G60691-0004
122-8	G60605-0808	29FIFSB-55	G37508-0505	29PO3-65	G36195-0605	39IF-5	G60691-0005
123-128	G60605-0812	29FIFSB-65	G37508-0605	29PO3-66	G36195-0606	39IF-6	G60691-0006
123-42	G60605-0204	29FIFSB-66	G37508-0606	29PO3-68	G36195-0608	40-10	G60643-0010
123-62	G60605-0206	29FIFSB-44	G37500-0404	29PO3-810	G36195-0810	40-12	G60643-0012
123-64	G60605-0406	29FIFSB-45	G37500-0405	29PO3-88	G36195-0808	40-3	G60643-0003
123-84	G60605-0408	29FIFSB-54	G37500-0504	29PO4-1012	G36111-1012	40-4	G60643-0004
123-86	G60605-0608	29FIFSB-55	G37500-0505	29PO4-1212	G36111-1212	40-5	G60643-0005
124-12	G60635-1212	29FIFSB-56	G37500-0506	29PO4-42	G36111-0402	40-6	G60643-0006
124-2	G60635-0202	29FIFSB-65	G37500-0605	29PO4-44	G36111-0404	40-8	G60643-0008
124-4	G60635-0404	29FIFSB-66	G37500-0606	29PO4-46	G36111-0406	40P	G33715-0606
124-6	G60635-0606	29IMES-44	G37504-0404	29PO4-64	G36111-0604	41L-10	G60685-0010

Competitive Interchange

Interchange No.	Gates No.	Interchange No.	Gates No.	Interchange No.	Gates No.	Interchange No.	Gates No.
MID-AMERICA - CONT.		MID-AMERICA - CONT.		MID-AMERICA - CONT.		MID-AMERICA - CONT.	
41L-12	G60685-0012	45-86	G60657-0806	49-1212BS	G60654-1212	67C	G33705-0806
41L-4	G60685-0004	45-88	G60657-0808	49-128BS	G60654-1208	67SAE	G33720-0806
41L-5	G60685-0005	46-1012	G60660-1012	49-32BS	G60654-0302	68C	G33701-0808
41L-6	G60685-0006	46-108	G60660-1008	49-42BS	G60654-0402	68SAE	G33730-0808
41L-8	G60685-0008	46-1212	G60660-1212	49-44BS	G60654-0404	6-PAC	G33832-0202
41P	G33801-0002	46-128	G60660-1208	4945-108	G60652-1008	77SAE	G33720-0808
42-10	G60645-1010	46-22	G60660-0202	4945-128	G60652-1208	7-PAC	G33832-0404
42-12	G60645-1212	46-32	G60660-0302	4945F-1212	G60652-1212	80P	G33715-0808
421P	G33831-0004	464-10	G60684-0010	4945F-42	G60652-0402	8-PAC	G33832-0606
42-2	G60645-0202	464-12	G60684-0012	4945F-44	G60652-0404	9-PAC	G33832-0808
42-3	G60645-0303	46-42	G60660-0402	4945F-52	G60652-0502	DQ64-12	G31450-1212
42-4	G60645-0404	464-4	G60684-0004	4945F-54	G60652-0504	HE60-6	G33050-0006
42-5	G60645-0505	46-44	G60660-0404	4945F-64	G60652-0604	HE60-8	G33050-0008
42-6	G60645-0606	464-5	G60684-0005	4945F-66	G60652-0606	HE61-6	G33060-0006
42-8	G60645-0808	464-6	G60684-0006	4945F-68	G60652-0608	HE61-8	G33060-0008
42IF-2	G60693-0002	46-46	G60660-0406	4945F-86	G60652-0806	HE61G-6	G33112-0006
42IF-3	G60693-0003	464-8	G60684-0008	4945F-88	G60652-0808	HE61G-8	G33112-0008
42IF-4	G60693-0004	46-48	G60660-0408	49-46BS	G60654-0406	HE61IN-6	G33061-0006
42IF-5	G60693-0005	46-52	G60660-0502	49-52BS	G60654-0502	HE61IN-8	G33061-0008
42IF-6	G60693-0006	46-54	G60660-0504	49-54BS	G60654-0504	HE62-6	G33400-0606
42IF-8	G60693-0008	46-56	G60660-0506	49-56BS	G60654-0506	HE62-8	G33400-0808
42P	G33801-0004	46-62	G60660-0602	49-62BS	G60654-0602	HE68-64	G33100-0604
42R-106	G60645-1006	46-64	G60660-0604	49-64BS	G60654-0604	HE68-66	G33100-0606
42R-108	G60645-1008	46-66	G60660-0606	49-66BS	G60654-0606	HE68-68	G33100-0608
42R-1210	G60645-1210	46-68	G60660-0608	49-68BS	G60654-0608	HE68-86	G33100-0806
42R-128	G60645-1208	46-84	G60660-0804	49-812BS	G60654-0812	HE68-88	G33100-0808
42R-43	G60645-0403	46-86	G60660-0806	49-84BS	G60654-0804	HE68B-64	G33111-0604
42R-54	G60645-0504	46-88	G60660-0808	49-86BS	G60654-0806	HE68B-66	G33111-0606
42R-64	G60645-0604	46IF-108	G60630-1008	49-88BS	G60654-0808	HE68B-68	G33111-0608
42R-65	G60645-0605	46IF-32	G60630-0302	49F-22	G60654-0202	HE68B-86	G33111-0806
42R-84	G60645-0804	46IF-42	G60630-0402	49P	G33710-0404	HE68B-88	G33111-0808
42R-86	G60645-0806	46IF-44	G60630-0404	50-42	G60664-0402	HE68G-64	G33110-0604
43-42	G60690-0402	46IF-52	G60630-0502	50F-108	G60664-1008	HE68G-66	G33110-0606
43-64	G60690-0604	46IF-64	G60630-0604	50F-1212	G60664-1212	HE68G-68	G33110-0608
43P	G33801-0006	46IF-86	G60630-0806	50F-32	G60664-0302	HE68G-86	G33110-0806
44F-10	G60669-1010	46-PAC	G33805-0202	50F-44	G60664-0404	HE68G-88	G33110-0808
44F-12	G60669-1212	47-PAC	G33805-0404	50F-52	G60664-0502	HE68S-64	G33151-0604
44F-2	G60669-0202	48-1012	G60650-1012	50F-54	G60664-0504	HE68S-66	G33151-0606
44F-3	G60669-0303	48-106	G60650-1006	50F-64	G60664-0604	HE68S-86	G33151-0806
44F-4	G60669-0404	48-108	G60650-1008	50F-66	G60664-0606	HE68S-88	G33151-0808
44F-5	G60669-0504	48-1212	G60650-1212	50F-86	G60664-0806	NT60-10	G32050-0010
44F-6	G60669-0606	48-128	G60650-1208	50F-88	G60664-0808	NT60-12	G32050-0012
44F-8	G60669-0808	48-22	G60650-0202	50P	G33710-0606	NT60-4	G32050-0004
44P	G33801-0008	48-44	G60650-0404	51F-108	G60659-0810	NT60-6	G32050-0006
44R-10106	G60670-1006	48-46	G60650-0406	51F-1212	G60659-1212	NT60-8	G32050-0008
44R-10108	G60670-1008	48-48	G60650-0408	51F-128	G60659-0812	NT61-10	G32060-0010
44R-1066	G60669-1006	48-52	G60650-0502	51F-32	G60659-0203	NT61-12	G32060-0012
44R-10810	G60671-1008	48-54	G60650-0504	51F-42	G60659-0204	NT61-4	G32060-0004
44R-1088	G60669-1008	48-56	G60650-0506	51F-44	G60659-0404	NT61-6	G32060-0006
44R-121012	G60671-1210	48-62	G60650-0602	51F-46	G60659-0604	NT61-8	G32060-0008
44R-121210	G60669-1210	48-64	G60650-0604	51F-52	G60659-0205	NT62-10	G32400-1010
44R-446	G60669-0406	48-66	G60650-0606	51F-54	G60659-0405	NT62-12	G32400-1212
44R-664	G60669-0604	48-68	G60650-0608	51F-62	G60659-0206	NT62-4	G32400-0404
44R-668	G60669-0608	48-812	G60650-0812	51F-64	G60659-0406	NT62-6	G32400-0606
44R-866	G60670-0806	48-84	G60650-0804	51F-66	G60659-0606	NT62-8	G32400-0808
44R-868	G60671-0806	48-86	G60650-0806	51F-68	G60659-0806	NT62BH-10	G32300-1010
44R-8810	G60669-0810	48-88	G60650-0808	51F-86	G60659-0608	NT62BH-4	G32300-0404
44R-886	G60669-0806	48A-PAC	G33805-0808	51F-88	G60659-0808	NT62BH-6	G32300-0606
45-1012	G60657-1012	48IF-108	G60625-1008	52F-4	G60680-0404	NT62BH-8	G32300-0808
45-108	G60657-1008	48IF-22	G60625-0202	52F-5	G60680-0505	NT63B-10	G32040-0010
45-1212	G60657-1212	48IF-32	G60625-0302	52F-6	G60680-0606	NT63B-12	G32040-0012
45-128	G60657-1208	48IF-42	G60625-0402	52F-8	G60680-0808	NT63B-4	G32040-0004
45-22	G60657-0202	48IF-44	G60625-0404	557C	G33705-0606	NT63B-6	G32040-0006
45-32	G60657-0302	48IF-52	G60625-0502	557SAE	G33720-0606	NT63B-8	G32040-0008
45-42	G60657-0402	48IF-54	G60625-0504	55F-10	G60648-1010	NT64-10	G32450-1010
45-44	G60657-0404	48IF-62	G60625-0602	55F-12	G60648-1212	NT64-4	G32450-0404
45-46	G60657-0406	48IF-64	G60625-0604	55F-2	G60648-0202	NT64-6	G32450-0606
45-48	G60657-0408	48IF-66	G60625-0606	55F-4	G60648-0404	NT64-8	G32450-0808
45-52	G60657-0502	48IF-84	G60625-0804	55F-5	G60648-0505	NT65-10	G32404-1010
45-54	G60657-0504	48IF-86	G60625-0806	55F-6	G60648-0606	NT65-4	G32404-0404
45-62	G60657-0602	48IF-88	G60625-0808	55F-8	G60648-0808	NT65-6	G32404-0606
45-64	G60657-0604	48P	G33710-0202	577SAE	G33720-0608	NT65-8	G32404-0808
45-66	G60657-0606	48-PAC	G33805-0606	57C	G33705-0604	NT66-106	G32150-1006
45-68	G60657-0608	49-1012BS	G60654-1012	57SAE	G33720-0604	NT66-108	G32150-1008
45-812	G60657-0812	49-106BS	G60654-1006	58C	G33701-0606	NT66-128	G32150-1208
45-84	G60657-0804	49-108BS	G60654-1008	58SAE	G33730-0606		

AIR BRAKE NYLON TUBING
AIR BRAKE COPPER TUBING
AIR BRAKE SURELOK
COMPOSITE AIR BRAKE SURELOK
AIR BRAKE COMPRESSION FITTINGS
AIR BRAKE COUPLINGS FOR RUBBER HOSE
VALVES
BRASS LOCK-ON FIELD ATTACHABLE COUPLINGS
SINGLE BEAD
BARB STEM
INVERTED FLARE
AUTOMOTIVE ADAPTERS
COPPER TUBING INDUSTRIAL COMPRESSION
INDUSTRIAL SURELOK
MINI-BARBED TUBE
POLY INDUSTRIAL COMPRESSION
PIPE ADAPTERS
ADAPTERS SAE FLARE
THREADED SLEEVE
KITS & ASSORTMENTS

Competitive Interchange

Interchange No.	Gates No.	Interchange No.	Gates No.	Interchange No.	Gates No.	Interchange No.	Gates No.
PARKER - CONT.		PARKER - CONT.		TRAMEC SLOAN - CONT.		TRAMEC SLOAN - CONT.	
61NTA-10	G32060-0010	VS68NTA-6-6	G32100-0606	S145-12-8	G60657-1208	S361ABS-8	G33061-0008
61NTA-12	G32060-0012	VS68NTA-6-8	G32100-0608	S145-3-2	G60657-0302	S362RB-6	G33400-0606
61NTA-4	G32060-0004	VS68NTA-8-4	G32100-0804	S145-4-2	G60657-0402	S362RB-8	G33400-0808
61NTA-6	G32060-0006	VS68NTA-8-6	G32100-0806	S145-4-4	G60657-0404	S363RB-6	G33151-0604
61NTA-8	G32060-0008	VS68NTA-8-8	G32100-0808	S145-5-2	G60657-0502	S363RB-8	G33151-0806
61RB-6	G33060-0006	TRAMEC SLOAN		S145-6-4	G60657-0604	S368AB-6-4	G33100-0604
61RB-8	G33060-0008	451029	H30002-02	S145-6-6	G60657-0606	S368AB-6-4-1	G33111-0604
61RBSG-6	G33061-0006	451030	H30002-04	S145-6-8	G60657-0608	S368AB-6-6	G33100-0606
61RBSG-8	G33061-0008	451031	H30002-06	S145-8-6	G60657-0806	S368AB-6-6-1	G33111-0606
62NBH-4	G32300-0404	451032	H30002-08	S145-8-8	G60657-0808	S368AB-6-8	G33100-0608
62NBH-6	G32300-0606	451033	H30002-10	S151-10-8	G60659-0810	S368AB-6-8-1	G33111-0608
62NBH-8	G32300-0808	451033	H30003-10	S151-3-2	G60659-0203	S368AB-8-6	G33100-0806
62NTA-10	G32400-1010	451034	H30003-12	S151-4-2	G60659-0204	S368AB-8-6-1	G33111-0806
62NTA-12	G32400-1212	451054	H30002-05	S151-4-4	G60659-0404	S368AB-8-8	G33100-0808
62NTA-4	G32400-0404	451029-2000	H30000-02	S151-5-2	G60659-0205	S368AB-8-8-1	G33111-0808
62NTA-6	G32400-0606	451030-1000	H30000-04	S151-5-4	G60659-0405	S371AS-6	G33112-0006
62NTA-8	G32400-0808	451030B	H30062-04	S151-6-2	G60659-0206	S371AS-8	G33112-0008
62RB-6	G33400-0606	451030G	H30042-04	S151-6-4	G60659-0406	S376AB-3/4-4	G33030-0604
62RB-8	G33400-0808	451030NG	H30082-04	S151-6-6	G60659-0606	S376AB-3/4-6	G33030-0606
66NTA-6-2	G32150-0602	451030R	H30052-04	S151-6-8	G60659-0806	S376AB-7/8-6	G33030-0806
66NTA-6-4	G32150-0604	451030Y	H30072-04	S151-8-6	G60659-0608	S378AB-6-4	G33110-0604
66NTA-6-6	G32150-0606	451031-500	H30000-06	S151-8-8	G60659-0808	S378AB-6-6	G33110-0606
66NTA-8-6	G32150-0806	451031B	H30062-06	S155-10-8	G60648-1010	S378AB-6-8	G33110-0608
66RBSV-6-3/4	G33150-0606	451031G	H30082-06	S155-12	G60648-1212	S378AB-8-6	G33110-0806
66RBSV-8-7/8	G33150-0808	451031R	H30052-06	S155-2	G60648-0202	S378AB-8-8	G33110-0808
68RB-6-4	G33100-0604	451031Y	H30072-06	S155-4	G60648-0404	S39-10	G60644-0010
68RB-6-6	G33100-0606	451032-500	H30000-08	S155-5	G60648-0505	S39-4	G60644-0004
68RB-6-8	G33100-0608	451032B	H30062-08	S155-6	G60648-0606	S39-5	G60644-0005
68RB-8-6	G33100-0806	451032G	H30042-08	S155-8	G60648-0808	S39-6	G60644-0006
68RB-8-8	G33100-0808	451032NG	H30082-08	S159-10-8	G60652-1008	S39-8	G60644-0008
68RBSG-6-4	G33110-0604	451032R	H30052-08	S159-4-2	G60652-0402	S40-10	G60643-0010
68RBSG-6-6	G33110-0606	451032Y	H30072-08	S159-4-4	G60652-0404	S40-3	G60643-0003
68RBSG-6-8	G33110-0608	451033-250	H30000-10	S159-6-4	G60652-0604	S40-4	G60643-0004
68RBSG-8-6	G33110-0806	451033B	H30063-10	S159-6-6	G60652-0606	S40-5	G60643-0005
68RBSG-8-8	G33110-0808	451033G	H30043-10	S159-8-6	G60652-0806	S40-6	G60643-0006
76RB-3/4-4	G33030-0604	451033NG	H30083-10	S200-2	G60637-0202	S40-8	G60643-0008
76RB-3/4-6	G33030-0606	451033R	H30053-10	S200-4	G60637-0404	S41L-10	G60685-0010
76RB-7/8-6	G33030-0806	451033Y	H30073-10	S200-6	G60637-0606	S41L-4	G60685-0004
76RB-7/8-8	G33030-0808	451034-250	H30000-12	S200-8	G60637-0808	S41L-5	G60685-0005
LV91	G33111-0606	451034B	H30063-12	S202-12	G60620-1212	S41L-6	G60685-0006
PFT-10B	H30000-10	451034G	H30043-12	S202-2	G60620-0202	S41L-8	G60685-0008
PFT-12B	H30000-12	451034R	H30053-12	S202-4	G60620-0404	S42-10	G60645-1010
PFT-2A	H30000-02	451054-500	H30000-05	S202-4-2	G60620-0204	S42-10-6	G60645-1006
PFT-4A	H30000-04	S104-2	G60632-0202	S202-6	G60620-0606	S42-10-8	G60645-1008
PFT-5A	H30000-05	S104-4	G60632-0404	S202-8-6	G60620-0608	S42-12	G60645-1212
PFT-6B	H30000-06	S104-6	G60632-0606	S202-8-8	G60620-0808	S42-12-10	G60645-1210
PFT-8B	H30000-08	S104-8	G60632-0808	S203-2	G60640-0202	S42-12-8	G60645-1208
VS269NTA-10-6	G32104-1006	S113-02-2-RB	G60608-0202	S203-4	G60640-0404	S42-2	G60645-0202
VS269NTA-10-8	G32104-1008	S113-04-2-R	G60608-0404	S203-6	G60640-0606	S42-3	G60645-0303
VS269NTA-4-2	G32104-0402	S113-12-2-R	G60608-1212	S203-8	G60640-0808	S42-4	G60645-0404
VS269NTA-4-4	G32104-0404	S119-4-2	G60631-0402	S207-12	G60631-1212	S42-5	G60645-0505
VS269NTA-4-6	G32104-0406	S119-6-2	G60631-0602	S207-2	G60631-0202	S42-6	G60645-0606
VS269NTA-6-2	G32104-0602	S119-6-4	G60631-0604	S207-4	G60631-0404	S42-6-4	G60645-0604
VS269NTA-6-4	G32104-0604	S119-8-6	G60631-0806	S207-6	G60631-0606	S42-6-5	G60645-0605
VS269NTA-6-6	G32104-0606	S120-12-8	G60615-0812	S207-8	G60631-0808	S42-8	G60645-0808
VS269NTA-6-8	G32104-0608	S120-2	G60615-0202	S213-2	G60600-0002	S42-8-4	G60645-0804
VS269NTA-8-4	G32104-0804	S120-4	G60615-0404	S213-4	G60600-0004	S42-8-6	G60645-0806
VS269NTA-8-6	G32104-0806	S120-4-2	G60615-0204	S213-6	G60600-0006	S44-10-10-8	G60670-1008
VS269NTA-8-8	G32104-0808	S120-6	G60615-0606	S213-8	G60600-0008	S44-10-6-6	G60669-1006
VS271NTA-6-6	G32130-0606	S120-6-2	G60615-0206	S224-2	G60635-0202	S44-6-6-8	G60669-0608
VS272NTA-10-8	G32134-1008	S120-6-4	G60615-0406	S224-4	G60635-0404	S44-8-6-6	G60670-0806
VS272NTA-4-2	G32134-0402	S120-8	G60615-0808	S224-6	G60635-0606	S44-8-6-8	G60671-0806
VS272NTA-4-4	G32134-0404	S120-8-4	G60615-0408	S224-8	G60635-0808	S44-8-8-6	G60669-0806
VS272NTA-6-4	G32134-0604	S120-8-6	G60615-0608	S225-2	G60641-0202	S46-10-12	G60660-1012
VS272NTA-6-6	G32134-0606	S144-10	G60669-1010	S225-4	G60641-0404	S46-10-8	G60660-1008
VS272NTA-8-6	G32134-0806	S144-12	G60669-1212	S225-6	G60641-0606	S46-12-12	G60660-1212
VS272NTA-8-8	G32134-0808	S144-2	G60669-0202	S225-8	G60641-0808	S46-12-8	G60660-1208
VS68NTA-10-6	G32100-1006	S144-3	G60669-0303	S226-12	G60642-1212	S46-3-2	G60660-0302
VS68NTA-10-8	G32100-1008	S144-5	G60669-0505	S226-2	G60642-0202	S46-4-2	G60660-0402
VS68NTA-12-12	G32100-1212	S144-6	G60669-0606	S226-4	G60642-0404	S46-4-4	G60660-0404
VS68NTA-12-8	G32100-1208	S144-8	G60669-0808	S226-6	G60642-0606	S46-4-6	G60660-0406
VS68NTA-4-2	G32100-0402	S145-10-8	G60657-1008	S226-8	G60642-0808	S46-4-8	G60660-0408
VS68NTA-4-4	G32100-0404	S145-12-12	G60657-1212	S360AB-6	G33050-0006	S46-5-2	G60660-0502
VS68NTA-4-6	G32100-0406			S360AB-8	G33050-0008	S46-5-4	G60660-0504
VS68NTA-6-2	G32100-0602			S361AB-6	G33060-0008	S46-6-2	G60660-0602
VS68NTA-6-4	G32100-0604			S361ABS-6	G33061-0006	S46-6-4	G60660-0604

AIR BRAKE NYLON TUBING
AIR BRAKE COPPER TUBING
AIR BRAKE SURELOK
COMPOSITE AIR BRAKE SURELOK
AIR BRAKE COMPRESSION FITTINGS
AIR BRAKE COUPLINGS FOR RUBBER HOSE
VALVES
BRASS LOCK-ON FIELD ATTACHABLE COUPLINGS
SINGLE BEAD
BARB STEM
INVERTED FLARE
AUTOMOTIVE ADAPTERS
COPPER TUBING INDUSTRIAL COMPRESSION
INDUSTRIAL SURELOK
MINI-BARBED TUBE
POLY INDUSTRIAL COMPRESSION
PIPE ADAPTERS
ADAPTERS SAE FLARE
THREADED SLEEVE
KITS & ASSORTMENTS

Competitive Interchange

AIR BRAKE NYLON TUBING
AIR BRAKE COPPER TUBING
AIR BRAKE SURELOK
COMPOSITE AIR BRAKE SURELOK
AIR BRAKE COMPRESSION FITTINGS
AIR BRAKE COUPLINGS FOR RUBBER HOSE
VALVES
BRASS LOCK-ON FIELD ATTACHABLE COUPLINGS
SINGLE BEAD
BARB STEM
INVERTED FLARE
AUTOMOTIVE ADAPTERS
COPPER TUBING INDUSTRIAL COMPRESSION
INDUSTRIAL SURELOK
MINI-BARBED TUBE
POLY INDUSTRIAL COMPRESSION
PIPE ADAPTERS
ADAPTERS SAE FLARE
THREADED SLEEVE
KITS & ASSORTMENTS

Interchange No.	Gates No.	Interchange No.	Gates No.	Interchange No.	Gates No.	Interchange No.	Gates No.
TRAMEC SLOAN - CONT.		TRAMEC SLOAN - CONT.		TRAMEC SLOAN - CONT.		VELVAC - CONT.	
S46-6-6.....	G60660-0606	S690-6-6.....	G36200-0606	S771AB-4-2.....	G32130-0204	016200.....	G32400-1010
S46-6-8.....	G60660-0608	S692-6-5.....	G36508-0605	S771AB-4-4.....	G32130-0404	016201.....	G32400-1212
S46-8-4.....	G60660-0804	S692-8-8.....	G36508-0808	S771AB-6-4.....	G32130-0406	016240.....	G32400-0404
S46-8-6.....	G60660-0806	S760AB-10.....	G32050-0010	S771AB-6-6.....	G32130-0606	016260.....	G32400-0606
S46-8-8.....	G60660-0808	S760AB-12.....	G32050-0012	S771AB-8-6.....	G32130-0608	016280.....	G32400-0808
S48-10-12.....	G60650-1012	S760AB-4.....	G32050-0004	S771AB-8-8.....	G32130-0808	016300.....	G32050-0010
S48-10-8.....	G60650-1008	S760AB-6.....	G32050-0006	S772AB-10-8.....	G32134-1008	016301.....	G32050-0012
S48-12-12.....	G60650-0202	S760AB-8.....	G32050-0008	S772AB-4-2.....	G32134-0402	016340.....	G32050-0004
S48-12-12.....	G60650-1212	S761AB-10.....	G32060-0010	S772AB-4-4.....	G32134-0404	016360.....	G32050-0006
S48-12-8.....	G60650-1208	S761AB-12.....	G32060-0012	S772AB-6-2.....	G32134-0602	016380.....	G32050-0008
S48-4-4.....	G60650-0404	S761AB-4.....	G32060-0004	S772AB-6-4.....	G32134-0604	016440.....	G32450-0404
S48-4-6.....	G60650-0406	S761AB-6.....	G32060-0006	S772AB-6-6.....	G32134-0606	016460.....	G32450-0606
S48-4-8.....	G60650-0408	S761AB-8.....	G32060-0008	S772AB-8-6.....	G32134-0806	016480.....	G32450-0808
S48-5-2.....	G60650-1006	S762AB-10.....	G32400-1010	S772AB-8-8.....	G32134-0808	016560.....	G32404-0606
S48-5-4.....	G60650-0504	S762AB-12.....	G32400-1212	S774AB-4.....	G32300-0404	016580.....	G32404-0808
S48-5-6.....	G60650-0506	S762AB-4.....	G32400-0404	S774AB-6.....	G32300-0606	016662.....	G32150-0602
S48-6-2.....	G60650-0602	S762AB-6.....	G32400-0606	S774AB-8.....	G32300-0808	016664.....	G32150-0604
S48-6-4.....	G60650-0604	S762AB-8.....	G32400-0808	S779AB-10-8.....	G32102-1008	016806.....	G32100-1006
S48-6-6.....	G60650-0606	S763AB-10.....	G32040-0010	S779AB-4-2.....	G32102-0402	016808.....	G32100-1008
S48-6-8.....	G60650-0608	S763AB-12.....	G32040-0012	S779AB-4-4.....	G32102-0404	016811.....	G32100-1212
S48-8-12.....	G60650-0812	S763AB-4.....	G32040-0004	S779AB-6-2.....	G32102-0602	016818.....	G32100-1208
S48-8-4.....	G60650-0804	S763AB-6.....	G32040-0006	S779AB-6-4.....	G32102-0604	016842.....	G32100-0402
S48-8-6.....	G60650-0806	S763AB-8.....	G32040-0008	S779AB-6-6.....	G32102-0606	016844.....	G32100-0404
S48-8-8.....	G60650-0808	S764AB-10.....	G32450-1010	S779AB-6-8.....	G32102-0608	016846.....	G32100-0606
S49-10-8.....	G60654-1008	S764AB-4.....	G32450-0404	S779AB-8-6.....	G32102-0806	016862.....	G32100-0602
S49-3-2.....	G60654-0302	S764AB-6.....	G32450-0606	S779AB-8-8.....	G32102-0808	016864.....	G32100-0604
S49-4-2.....	G60654-0402	S764AB-8.....	G32450-0808	SDC604-2.....	G33830-0002	016866.....	G32100-0606
S49-4-4.....	G60654-0404	S765AB-10.....	G32404-1010	SDC604-4.....	G33830-0004	016868.....	G32100-0608
S49-4-6.....	G60654-0406	S765AB-4.....	G32404-0404	SDC604-6.....	G33830-0006	016884.....	G32100-0804
S49-5-2.....	G60654-0502	S765AB-6.....	G32404-0606	SFB-10.....	G60684-0010	016886.....	G32100-0806
S49-5-4.....	G60654-0504	S765AB-8.....	G32404-0808	SFB-12.....	G60684-0012	016888.....	G32100-0808
S49-6-2.....	G60654-0602	S766AB-10-6.....	G32150-1006	SFB-4.....	G60684-0004	016906.....	G32104-1006
S49-6-4.....	G60654-0604	S766AB-10-8.....	G32150-1008	SFB-5.....	G60684-0005	016908.....	G32104-1008
S49-6-6.....	G60654-0606	S766AB-4-2.....	G32150-0402	SFB-6.....	G60684-0006	016911.....	G32104-1208
S49-6-8.....	G60654-0608	S766AB-4-4.....	G32150-0404	SFB-8.....	G60684-0008	016942.....	G32104-0402
S49-8-4.....	G60654-0804	S766AB-6-2.....	G32150-0602	SFF209-2.....	G33715-0202	016944.....	G32104-0404
S49-8-6.....	G60654-0806	S766AB-6-4.....	G32150-0604	SFF209-4.....	G33715-0404	016946.....	G32104-0406
S49-8-8.....	G60654-0808	S766AB-6-6.....	G32150-0606	SFF209-6.....	G33715-0606	016962.....	G32104-0602
S50-10-8.....	G60664-1008	S766AB-8-6.....	G32150-0806	SFF209-8.....	G33715-0808	016964.....	G32104-0604
S50-6-6.....	G60664-0606	S766AB-8-8.....	G32150-0808	SPHN-12.....	G60605-1212	016966.....	G32104-0606
S50-8-8.....	G60664-0808	S768AB-10-6.....	G32100-1006	SPHN-2.....	G60605-0202	016968.....	G32104-0608
S625-10-12.....	G36100-1012	S768AB-10-8.....	G32100-1008	SPHN-4.....	G60605-0404	016984.....	G32104-0804
S625-10-6.....	G36100-1006	S768AB-12-12.....	G32100-1212	SPHN-4-2.....	G60605-0204	016986.....	G32104-0806
S625-10-8.....	G36100-1008	S768AB-12-8.....	G32100-1208	SPHN-6.....	G60605-0606	016988.....	G32104-0808
S625-12-12.....	G36100-1212	S768AB-4-2.....	G32100-0402	SPHN-6-2.....	G60605-0206	017064.....	G32154-0604
S625-12-8.....	G36100-1208	S768AB-4-4.....	G32100-0404	SPHN-6-4.....	G60605-0406	017242.....	G32134-0402
S625-4-2.....	G36100-0402	S768AB-4-6.....	G32100-0406	SPHN-8.....	G60605-0808	017264.....	G32134-0604
S625-4-4.....	G36100-0404	S768AB-6-2.....	G32100-0602	SPHN-8-4.....	G60605-0408	017266.....	G32134-0606
S625-4-6.....	G36100-0406	S768AB-6-4.....	G32100-0604	SPHN-8-6.....	G60605-0608	017286.....	G32134-0806
S625-5-2.....	G36100-0502	S768AB-6-6.....	G32100-0606	SPPH-12.....	G60601-0012	017808.....	G32102-1008
S625-5-4.....	G36100-0504	S768AB-6-8.....	G32100-0608	SPPH-2.....	G60601-0002	017842.....	G32102-0402
S625-6-2.....	G36100-0602	S768AB-8-4.....	G32100-0804	SPPH-4.....	G60601-0004	017844.....	G32102-0404
S625-6-4.....	G36100-0604	S768AB-8-6.....	G32100-0806	SPPH-6.....	G60601-0006	017862.....	G32102-0602
S625-6-6.....	G36100-0606	S768AB-8-8.....	G32100-0808	SPPH-8.....	G60601-0008	017864.....	G32102-0604
S625-8-4.....	G36100-0804	S769AB-10-6.....	G32104-1006	SV402-2.....	G33710-0202	017866.....	G32102-0606
S625-8-6.....	G36100-0806	S769AB-10-8.....	G32104-1008	SV402-4.....	G33710-0404	017868.....	G32102-0608
S625-8-8.....	G36100-0808	S769AB-12-8.....	G32104-1208	SV402-6.....	G33710-0606	017886.....	G32102-0806
S626-12-12.....	G36170-1212	S769AB-4-2.....	G32104-0402	SV601-2.....	G33801-0002	017888.....	G32102-0808
S626-4-6.....	G36170-0406	S769AB-4-4.....	G32104-0404	SV601-4.....	G33801-0004	035001.....	G33032-0006
S626-6-6.....	G36170-0606	S769AB-4-6.....	G32104-0406	SV601-6.....	G33801-0006	140000.....	G33030-0604
S628-12-12.....	G36105-1212	S769AB-6-2.....	G32104-0602	SV601-8.....	G33801-0008	142001.....	G33030-0606
S628-4-4.....	G36105-0404	S769AB-6-4.....	G32104-0604	SVC206-4-2.....	G33705-0402	500001.....	G33100-0608
S628-6-6.....	G36105-0606	S769AB-6-6.....	G32104-0606	SVC206-4-4.....	G33705-0404	500003.....	G33111-0608
S628-8-8.....	G36105-0808	S769AB-6-8.....	G32104-0608	SVC206-6-4.....	G33705-0604	500004.....	G33060-0006
S682-4-4.....	G36111-0404	S769AB-8-4.....	G32104-0804	SVC406P-4.....	G33650-0404	500005.....	G33050-0006
S682-6-6.....	G36111-0606	S769AB-8-6.....	G32104-0806	SVC406P-6.....	G33650-0606	500009.....	G33100-0606
S682-6-8.....	G36111-0608	S769AB-8-8.....	G32104-0808	SVC407P-4.....	G33655-0404	500011.....	G33111-0606
S682-8-8.....	G36111-0808	S770AB-10-8.....	G32154-1008	SVC407P-6.....	G33655-0606	500015.....	G33100-0604
S684-12-12.....	G36165-1212	S770AB-4-2.....	G32154-0402			500017.....	G33111-0604
S684-4-6.....	G36165-0406	S770AB-4-4.....	G32154-0404	VELVAC		500019.....	G33110-0608
S684-6-6.....	G36165-0606	S770AB-6-2.....	G32154-0602	016100.....	G32060-0010	500022.....	G33061-0006
S687-10-10.....	G36520-1010	S770AB-6-4.....	G32154-0604	016101.....	G32060-0012	500024.....	G33112-0006
S687-8-8.....	G36520-0808	S770AB-6-6.....	G32154-0606	016140.....	G32060-0004	500025.....	G33110-0606
S690-5-6.....	G36200-0506	S770AB-8-6.....	G32154-0806	016160.....	G32060-0006	500027.....	G33110-0604
		S770AB-8-8.....	G32154-0808	016180.....	G32060-0008	500031.....	G33400-0606
		S771AB-10-8.....	G32130-0810			500050.....	G33100-0808

Competitive Interchange

Interchange No.	Gates No.	Interchange No.	Gates No.	Interchange No.	Gates No.	Interchange No.	Gates No.
VELVAC - CONT.		WEATHERHEAD - CONT.		WEATHERHEAD - CONT.		WEATHERHEAD - CONT.	
500051.....	G33100-0806	00906B606.....	G36170-0606	10006B102.....	G36100-0602	1468X6X2.....	G32100-0602
500052.....	G33030-0806	00906BB06.....	G36500-0606	10006B106.....	G36100-0606	1468X6X6.....	G32100-0606
500053.....	G33111-0808	05703B102.....	G37100-0302	10006B256.....	G36110-0606	1468X6X8.....	G32100-0608
500054.....	G33060-0008	05704B102.....	G37100-0402	10006B306.....	G36195-0606	1468X8.....	G32100-0806
500055.....	G33050-0008	05704B104.....	G37100-0404	10006B405.....	G36210-0605	1468X8X4.....	G32100-0804
500061.....	G33111-0806	05704BB64.....	G37504-0404	10006B406.....	G36200-0606	1468X8X8.....	G32100-0808
500070.....	G33110-0808	05704BB65.....	G37504-0405	10006BA05.....	G36508-0605	1469X10.....	G32104-1008
500072.....	G33061-0008	05704BC02.....	G37106-0402	10006BB05.....	G36500-0605	1469X10X6.....	G32104-1006
500074.....	G33112-0008	05705B102.....	G37100-0502	10006BC02.....	G36106-0602	1469X12.....	G32104-1208
500078.....	G33110-0806	05705B104.....	G37100-0504	10006BC04.....	G36106-0406	1469X4.....	G32104-0402
500088.....	G33400-0808	05705B1560.....	G37500-0505	10006BY06.....	G36535-0606	1469X4X4.....	G32104-0404
		05705B1561.....	G37500-0506	10008B106.....	G36100-0806	1469X4X6.....	G32104-0406
		05705B1598.....	G37500-0504	10008B108.....	G36100-0808	1469X6.....	G32104-0604
		05705BC02.....	G37106-0502	10008B258.....	G36110-0808	1469X6X2.....	G32104-0602
		05705BC04.....	G37106-0504	10008B408.....	G36210-0808	1469X6X6.....	G32104-0606
		05706B102.....	G37100-0602	10008BA08.....	G36508-0808	1469X6X8.....	G32104-0608
		05706B104.....	G37100-0604	10008BB08.....	G36500-0808	1469X8.....	G32104-0806
		05706B106.....	G37100-0606	10008BY08.....	G36535-0808	1469X8X4.....	G32104-0804
		05706B1416.....	G37504-0605	10010B108.....	G36100-1008	1469X8X8.....	G32104-0808
		05706B1417.....	G37504-0606	10010B410.....	G36210-0810	1470X4.....	G32154-0402
		05706B1568.....	G37500-0605	10010B410.....	G36210-1010	1470X6.....	G32154-0604
		05706B1570.....	G37500-0606	10012B112.....	G36100-1212	1470X6X6.....	G32154-0606
		05706BC02.....	G37106-0602	10012B412.....	G36200-1212	1470X8.....	G32154-0806
		05706BC04.....	G37106-0604	10012B610.....	G36210-1210	1471X4.....	G32130-0204
		05706BC06.....	G37106-0606	10012B612.....	G36170-1212	1471X6.....	G32130-0406
		05710B106.....	G37100-1006	12EY62.....	G40460-1212B	1471X6X6X6.....	G32130-0606
		05710B108.....	G37100-1008	131X3.....	G60691-0003	1471X8.....	G32130-0608
		05710BC06.....	G37106-1006	131X4.....	G60691-0004	1472X10.....	G32134-1008
		05712B108.....	G37100-1208	131X5.....	G60691-0005	1472X4.....	G32134-0402
		0578B106.....	G37100-0806	131X6.....	G60691-0006	1472X6.....	G32134-0604
		0578B108.....	G37100-0808	1390X6.....	G33030-0604	1472X6X6X2.....	G32134-0602
		06904D102.....	G34100-0402	1390X6X6.....	G33030-0606	1472X6X6X6.....	G32134-0606
		06904D104.....	G34100-0404	1390X6X8.....	G33030-0806	1472X8.....	G32134-0806
		06904D604.....	G34210-0404	1390X8X8.....	G33030-0808	1472X8X8.....	G32134-0808
		06904DB04.....	G34500-0404	1391X6.....	G33111-0604	1474X10.....	G32300-1010
		06905D104.....	G34100-0504	1391X6X6.....	G33111-0606	1474X4.....	G32300-0404
		06905D605.....	G34210-0505	1391X6X8.....	G33111-0608	1474X6.....	G32300-0606
		06906D104.....	G34100-0604	1391X8.....	G33111-0806	1474X8.....	G32300-0808
		06906D406.....	G34200-0606	1391X8X8.....	G33111-0808	1480X10.....	G32102-1008
		06906D606.....	G34170-0606	1460X10.....	G32050-0010	1480X4.....	G32102-0402
		06906DB06.....	G34500-0605	1460X12.....	G32050-0012	1480X4X4.....	G32102-0404
		06908D106.....	G34100-0806	1460X4.....	G32050-0004	1480X6.....	G32102-0604
		06908D108.....	G34100-0808	1460X6.....	G32050-0006	1480X6X2.....	G32102-0602
		06908DB08.....	G34210-0808	1460X8.....	G32050-0008	1480X6X6.....	G32102-0606
		06910D108.....	G34100-1008	1461X10.....	G32060-0010	1480X6X8.....	G32102-0608
		06910D610.....	G34210-1010	1461X12.....	G32060-0012	1480X8.....	G32102-0806
		06912D112.....	G34100-1212	1461X4.....	G32060-0004	1480X8X8.....	G32102-0808
		06912D412.....	G34200-1212	1461X6.....	G32060-0006	1484X10.....	G32040-0010
		06912D612.....	G34170-1212	1461X8.....	G32060-0008	1484X12.....	G32040-0012
		06916D112.....	G34100-1612	1462X10.....	G32400-1010	1484X4.....	G32040-0004
		06916D116.....	G34100-1616	1462X12.....	G32400-1212	1484X6.....	G32040-0006
		06916D616.....	G34170-1616	1462X4.....	G32400-0404	1484X8.....	G32040-0008
		06916DX26.....	G34562-1616	1462X6.....	G32400-0606	1862X10.....	G31400-1010
		06920D120.....	G34100-2020	1462X8.....	G32400-0808	1862X25.....	G31400-2525
		06920D620.....	G34170-2020	1464X10.....	G32450-1010	1862X4.....	G31400-0404
		06924D124.....	G34100-2424	1464X4.....	G32450-0404	1862X6.....	G31400-0606
		06924D624.....	G34170-2424	1464X6.....	G32450-0606	1862X8.....	G31400-0808
		06932D132.....	G34100-3232	1464X8.....	G32450-0808	1864X12.....	G31450-1212
		06932D632.....	G34170-3232	1465X10.....	G32404-1010	1864X4.....	G31450-0404
		08ET60.....	G40461-1010B	1465X4.....	G32404-0404	1864X6.....	G31450-0606
		08EY58.....	G40460-0808B	1465X6.....	G32404-0606	1864X8.....	G31450-0808
		08EY60.....	G40460-1010B	1465X8.....	G32404-0808	1865X4.....	G31404-0404
		10004B254.....	G36110-0404	1466X12.....	G32150-1208	1865X6.....	G31404-0606
		10004B304.....	G36195-0404	1466X4.....	G32150-0402	1865X8.....	G31404-0808
		10004B305.....	G36195-0405	1466X6.....	G32150-0604	1866X4.....	G31150-0402
		10004B306.....	G36195-0406	1466X6X2.....	G32150-0602	1866X4X4.....	G31150-0404
		10004B405.....	G36210-0405	1466X6X6.....	G32150-0606	1866X6.....	G31150-0604
		10004BB03.....	G36500-0403	1466X8.....	G32150-0806	1866X6X6.....	G31150-0606
		10004BB04.....	G36500-0404	1468X10.....	G32100-1008	1866X8.....	G31150-0806
		10004BB05.....	G36500-0405	1468X10X6.....	G32100-1006	1866X8X8.....	G31150-0808
		10004BY04.....	G36535-0404	1468X12.....	G32100-1208	1868X10.....	G31100-1008
		10005B102.....	G36100-0502	1468X12X12.....	G32100-1212	1868X10X6.....	G31100-1006
		10005B104.....	G36100-0504	1468X4.....	G32100-0402	1868X12.....	G31100-1212
		10005BB04.....	G36500-0504	1468X4X4.....	G32100-0404	1868X12X8.....	G31100-1208
		10005BB06.....	G36500-0506	1468X4X6.....	G32100-0406	1868X25.....	G31100-2502
		10005BY05.....	G36535-0505	1468X6.....	G32100-0604	1868X25X1.....	G31100-2501

AIR BRAKE NYLON TUBING
AIR BRAKE COPPER TUBING
AIR BRAKE SURELOK
COMPOSITE AIR BRAKE SURELOK
AIR BRAKE COMPRESSION FITTINGS
AIR BRAKE COUPLINGS FOR RUBBER HOSE
VALVES
BRASS LOCK-ON FIELD ATTACHABLE COUPLINGS
SINGLE BEAD
BARB STEM
INVERTED FLARE
AUTOMOTIVE ADAPTERS
COPPER TUBING INDUSTRIAL COMPRESSION
INDUSTRIAL SURELOK
MINI-BARBED TUBE
POLY INDUSTRIAL COMPRESSION
PIPE ADAPTERS
ADAPTERS SAE FLARE
THREADED SLEEVE
KITS & ASSORTMENTS

Competitive Interchange

Interchange No.	Gates No.	Interchange No.	Gates No.	Interchange No.	Gates No.	Interchange No.	Gates No.
WEATHERHEAD - CONT.		WEATHERHEAD - CONT.		WEATHERHEAD - CONT.		WEATHERHEAD - CONT.	
42X5	G60645-0505	48X2	G60650-0202	51X12x12	G60659-1212	A6845	G33905-0302
42X6	G60645-0606	48X3	G60650-0302	51X3	G60659-0203	A6855	G33905-0504
42X8	G60645-0808	48X4	G60650-0402	51X4	G60659-0204	A6860	G33905-0604
43X4	G60690-0402	48X4X4	G60650-0404	51X4x4	G60659-0404	A690	G33910-0402
43X6	G60690-0604	48X5	G60650-0502	51X5	G60659-0205	A694	G33705-0402
44X02	G60669-0202	48X5X4	G60650-0504	51X5X4X5	G60659-0405	NT10002BK100	H30002-02
44X10	G60669-1010	48X6	G60650-0604	51X6	G60659-0406	NT10003BK100	H30002-03
44X12	G60669-1212	48X6X2	G60650-0602	51X6X6X6	G60659-0606	NT10004BK100	H30002-04
44X3	G60669-0303	48X6X6	G60650-0606	51X8	G60659-0608	NT10004BU100	H30062-04
44X4	G60669-0404	48X6X8	G60650-0608	51X8X8X8	G60659-0808	NT10004GN100	H30042-04
44X5	G60669-0504	48X8	G60650-0806	54X10	G60652-1008	NT10004OR100	H30082-04
44X5	G60669-0505	48X8X4	G60650-0804	54X12	G60652-1212	NT10004RD100	H30052-04
44X6	G60669-0606	48X8X8	G60650-0808	54X4	G60652-0402	NT10004YW100	H30072-04
44X8	G60669-0808	49X10	G60654-1008	54X4X4	G60652-0404	NT10005BK100	H30002-05
45X10	G60657-1008	49X10X6	G60654-1006	54X5	G60652-0502	NT10005BK500	H30000-05
45X12	G60657-1208	49X12	G60654-1208	54X5X4	G60652-0504	NT10006BK100	H30002-06
45X3	G60657-0302	49X12X12	G60654-1212	54X6	G60652-0604	NT10006BU100	H30062-06
45X4	G60657-0402	49X2	G60654-0202	54X6X6	G60652-0606	NT10006GN100	H30042-06
45X4X4X4	G60657-0404	49X3	G60654-0302	54X8	G60652-0806	NT10006OR100	H30082-06
45X5	G60657-0502	49X4	G60654-0402	54X8X8	G60652-0808	NT10006RD100	H30052-06
45X5X5X4	G60657-0504	49X4X4	G60654-0404	55X10	G60648-1010	NT10006YW100	H30072-06
45X6	G60657-0604	49X4X6	G60654-0406	55X4	G60648-0404	NT10008BK100	H30002-08
45X6X6X6	G60657-0606	49X5	G60654-0502	55X5	G60648-0505	NT10008BU100	H30062-08
45X8	G60657-0806	49X5X4	G60654-0504	55X6	G60648-0606	NT10008GN100	H30042-08
45X8X8X8	G60657-0808	49X6	G60654-0604	55X8	G60648-0808	NT10008OR100	H30082-08
46X10	G60660-1008	49X6X2	G60654-0602	A555	G33905-0402	NT10008RD100	H30052-08
46X3	G60660-0302	49X6X6	G60654-0606	A655	G33905-0502	NT10008YW100	H30072-08
46X4	G60660-0402	49X6X8	G60654-0608	A660	G33910-0502	NT10010BK100	H30003-10
46X4X4	G60660-0404	49X8	G60654-0806	A664	G33705-0502	NT10010BU100	H30063-10
46X5	G60660-0502	49X8X4	G60654-0804	A6690	G33910-0302	NT10010GN100	H30043-10
46X5X4	G60660-0504	49X8X8	G60654-0808	A6754	G33705-0404	NT10010RD100	H30053-10
46X6	G60660-0604	50X10	G60664-1008	A6755	G33910-0504	NT10012BK100	H30003-12
46X6X2	G60660-0602	50X3	G60664-0302	A6759	G33705-0504	W1206	G30050-1208
46X6X6	G60660-0606	50X4	G60664-0402	A6760	G33910-0604	W13630	G33032-0006
46X6X8	G60660-0608	50X4X4	G60664-0404	A6763	G33901-0303	W1512	G30050-1508
46X8	G60660-0806	50X5	G60664-0502	A6764	G33705-0604	W15310	G33832-0404
46X8X4	G60660-0804	50X5X4	G60664-0504	A6765	G33901-0404	W20332	G33805-0404
46X8X8	G60660-0808	50X6	G60664-0604	A6769	G33701-0404	W75150	G33031-0608
48X10	G60650-1008	50X6X6	G60664-0606	A6770	G33901-0505	W79850	G33031-0508
48X10X6	G60650-1006	50X8	G60664-0806	A6774	G33701-0505		
48X12	G60650-1208	50X8X8	G60664-0808	A6775	G33901-0606		
48X12X12	G60650-1212	51X10	G60659-0810	A6779	G33701-0606		

AIR BRAKE NYLON TUBING
AIR BRAKE COPPER TUBING
AIR BRAKE SURELOK
COMPOSITE AIR BRAKE SURELOK
AIR BRAKE COMPRESSION FITTINGS
AIR BRAKE COUPLINGS FOR RUBBER HOSE
VALVES
BRASS LOCK-ON FIELD ATTACHABLE COUPLINGS
SINGLE BEAD
BARB STEM
INVERTED FLARE
AUTOMOTIVE ADAPTERS
COPPER TUBING INDUSTRIAL COMPRESSION
INDUSTRIAL SURELOK
MINI-BARBED TUBE
POLY INDUSTRIAL COMPRESSION
PIPE ADAPTERS
ADAPTERS SAE FLARE
THREADED SLEEVE
KITS & ASSORTMENTS

Part Number Index

Part Number	PAGE	Part Number	PAGE
G30050-0004	21	G31100-0602	29
G30050-0006	21	G31100-0604	29
G30050-0008	21	G31100-0606	29
G30050-0010	21	G31100-0608	29
G30050-0012	21	G31100-0804	29
G30050-1208	21	G31100-0806	29
G30050-1508	21	G31100-0808	29
G30060-0004	22	G31100-1006	29
G30060-0006	22	G31100-1008	29
G30060-0008	22	G31100-1208	29
G30060-0010	22	G31100-1212	29
G30060-0012	22	G31100-2501	29
G30100-0402	22	G31100-2502	29
G30100-0404	22	G31102-0402	29
G30100-0406	22	G31102-0404	29
G30100-0602	22	G31102-0602	29
G30100-0604	22	G31102-0604	29
G30100-0606	22	G31102-0606	29
G30100-0608	22	G31102-0608	29
G30100-0804	22	G31102-0804	29
G30100-0806	22	G31102-0806	29
G30100-0808	22	G31102-0808	29
G30100-1006	22	G31102-1006	29
G30100-1008	22	G31102-1008	29
G30100-1208	22	G31102-1208	30
G30102-0604	23	G31102-1212	30
G30102-0606	23	G31104-0202	30
G30102-0806	23	G31104-0302	30
G30102-1008	23	G31104-0402	30
G30104-0402	23	G31104-0404	30
G30104-0404	23	G31104-0406	30
G30104-0602	23	G31104-0408	30
G30104-0604	23	G31104-0602	30
G30104-0606	23	G31104-0604	30
G30104-0608	23	G31104-0606	30
G30104-0804	23	G31104-0608	30
G30104-0806	23	G31104-0804	30
G30104-0808	23	G31104-0806	30
G30104-1006	23	G31104-0808	30
G30104-1008	23	G31104-1006	30
G30104-1208	23	G31104-1008	30
G30106-0602	24	G31104-1208	30
G30106-0604	24	G31104-1212	30
G30106-0806	24	G31104-2501	30
G30130-0406	24	G31104-2502	30
G30130-0608	24	G31105-0604P	31
G30135-0602	24	G31105-0606P	31
G30135-0604	24	G31105-0806P	31
G30135-0606	24	G31105-0808P	31
G30135-0806	25	G31105-1212P	31
G30150-0602	25	G31122-0402	31
G30150-0604	25	G31122-0404	31
G30150-0606	25	G31122-0602	31
G30150-0806	25	G31122-0604	31
G30154-0604	25	G31122-0808	31
G30154-0806	25	G31122-1008	31
G30400-0404	25	G31124-0402	32
G30400-0606	25	G31124-0404	32
G30400-0808	25	G31124-0406	32
G30400-1010	26	G31124-0602	32
G30400-1212	26	G31124-0604	32
G30404-0606	26	G31124-0606	32
G30404-0808	26	G31124-0608	32
G30404-1010	26	G31124-0804	32
G30450-0606	26	G31124-0806	32
G30450-0808	26	G31124-0808	32
G31050-0004	28	G31124-1006	32
G31050-0006	28	G31124-1008	32
G31050-0008	28	G31124-1208	32
G31050-0025	28	G31124-2502	32
G31080-0003	28	G31130-0204	32
G31080-0004	28	G31130-0404	32
G31080-0006	28	G31130-0406	32
G31080-0008	28	G31130-0604	32
G31080-0010	28	G31130-0606	32
G31080-0012	28	G31130-0608	32
G31080-0025	28	G31130-0806	32
G31100-0202	29	G31131-0406	32
G31100-0302	29	G31131-0604	32
G31100-0401	29	G31131-0608	32
G31100-0402	29	G31132-0406	32
G31100-0404	29	G31132-0604	32
G31100-0406	29	G31132-0608	33
		G31134-0302	33

Part Number Index

Part Number	PAGE	Part Number	PAGE
G31134-0402	33	G31451-0804	39
G31134-0404	33	G31451-0806	39
G31134-0406	33	G31451-1008	39
G31134-0604	33	G31452-0604	39
G31134-0606	33	G31452-0806	39
G31134-0804	33	G31453-0608	39
G31134-0806	33	G31970-0604	41
G31134-0808	33	G32040-0004	43
G31135-0604	33	G32040-0004B	43
G31135-0806	33	G32040-0006	43
G31136-1008	33	G32040-0006B	43
G31138-0606	33	G32040-0008	43
G31140-0204	34	G32040-0008B	43
G31140-0404	34	G32040-0010	43
G31140-0406	34	G32040-0010B	43
G31140-0606	34	G32040-0012	43
G31140-0608	34	G32040-0012B	43
G31140-0808	34	G32050-0004	43
G31142-0302	34	G32050-0006	43
G31142-0402	34	G32050-0008	43
G31142-0404	34	G32050-0010	43
G31142-0602	34	G32050-0012	43
G31142-0604	34	G32060-0004	43
G31142-0606	34	G32060-0006	43
G31142-0804	34	G32060-0008	44
G31142-0806	34	G32060-0010	44
G31142-0808	34	G32060-0012	44
G31150-0402	35	G32100-0401	44
G31150-0404	35	G32100-0402	44
G31150-0602	35	G32100-0404	44
G31150-0604	35	G32100-0406	44
G31150-0606	35	G32100-0602	44
G31150-0804	35	G32100-0604	44
G31150-0808	35	G32100-0606	44
G31150-2502	35	G32100-0608	44
G31154-0302	35	G32100-0804	44
G31154-0402	35	G32100-0806	44
G31154-0404	35	G32100-0808	44
G31154-0406	35	G32100-0812	44
G31154-0602	35	G32100-1006	44
G31154-0604	35	G32100-1008	44
G31154-0606	35	G32100-1012	44
G31154-0804	35	G32100-1208	44
G31154-0806	35	G32100-1212	44
G31154-0808	35	G32102-0402	44
G31160-0604	36	G32102-0404	44
G31167-0406	36	G32102-0602	44
G31167-0808	36	G32102-0604	44
G31168-0604	36	G32102-0606	45
G31300-0404	37	G32102-0608	45
G31300-0606	37	G32102-0804	45
G31300-0806	37	G32102-0806	45
G31300-0808	37	G32102-0808	45
G31300-1010	37	G32102-1008	45
G31360-0402	37	G32104-0402	45
G31360-0404	37	G32104-0404	45
G31360-0604	37	G32104-0406	45
G31360-0606	37	G32104-0602	45
G31360-0608	37	G32104-0604	45
G31360-0806	37	G32104-0606	45
G31360-0808	37	G32104-0608	45
G31400-0202	37	G32104-0804	45
G31400-0303	37	G32104-0806	45
G31400-0404	38	G32104-0808	45
G31400-0604	38	G32104-1006	45
G31400-0606	38	G32104-1008	45
G31400-0806	38	G32104-1012	45
G31400-0808	38	G32104-1206	45
G31400-1010	38	G32104-1208	45
G31400-1212	38	G32104-1212	45
G31400-2525	38	G32106-0602	46
G31404-0404	38	G32106-0604	46
G31404-0606	38	G32106-0806	46
G31404-0808	38	G32130-0204	46
G31404-1010	38	G32130-0406	46
G31450-0202	38	G32130-0606	46
G31450-0303	38	G32130-0608	46
G31450-0404	38	G32130-0808	46
G31450-0606	38	G32130-0810	46
G31450-0808	38	G32131-0406	46
G31450-1010	38	G32134-0402	47
G31450-1212	38	G32134-0404	47
G31451-0604	39	G32134-0602	47
G31451-0608	39	G32134-0604	47

Part Number Index

Part Number	PAGE	Part Number	PAGE
G32134-0606	47	G33111-0806	55
G32134-0806	47	G33111-0808	55
G32134-0808	47	G33112-0006	55
G32134-1008	47	G33112-0008	55
G32136-0604	47	G33150-0606	55
G32136-0804	47	G33150-0808	55
G32136-0806	47	G33151-0604	55
G32150-0402	47	G33151-0606	55
G32150-0404	47	G33151-0608	56
G32150-0602	47	G33151-0806	56
G32150-0604	47	G33300-0202	141
G32150-0606	47	G33300-0404	141
G32150-0806	47	G33300-0606	141
G32150-0808	47	G33300-0804	141
G32150-1006	47	G33300-0808	141
G32150-1008	47	G33301-0404	141
G32150-1208	47	G33301-0804	141
G32154-0402	48	G33302-0804	141
G32154-0404	48	G33303-0806	141
G32154-0602	48	G33400-0606	56
G32154-0604	48	G33400-0808	56
G32154-0606	48	G33610-0810	60
G32154-0806	48	G33612-0604	60
G32154-0808	48	G33612-0606	60
G32154-1008	48	G33612-0608	60
G32160-0604	48	G33612-0806	60
G32160-0804	48	G33612-0808	60
G32160-1004	48	G33612-1008	60
G32300-0404	48	G33612-1208	60
G32300-0606	48	G33620-0606	61
G32300-0808	48	G33620-0806	61
G32300-1010	49	G33620-1006	61
G32400-0404	49	G33620-1008	61
G32400-0606	49	G33620-1206	61
G32400-0808	49	G33620-1208	61
G32400-1010	49	G33622-0606	61
G32400-1212	49	G33622-1006	61
G32404-0404	49	G33630-0606	62
G32404-0606	49	G33630-0608	62
G32404-0808	49	G33630-0808	62
G32404-1010	49	G33650-0202	62
G32450-0404	50	G33650-0404	62
G32450-0406	50	G33650-0606	62
G32450-0604	50	G33655-0404	63
G32450-0606	50	G33655-0606	63
G32450-0608	50	G33656-0404	63
G32450-0806	50	G33656-0606	63
G32450-0808	50	G33701-0404	63
G32450-1010	50	G33701-0505	63
G32452-0806	50	G33701-0606	63
G32601-0808	58	G33701-0808	63
G32602-0808	58	G33705-0402	64
G33021-0004	59	G33705-0404	64
G33022-0002	59	G33705-0502	64
G33027-0006	59	G33705-0504	64
G33027-0008	59	G33705-0604	64
G33030-0604	52	G33705-0806	64
G33030-0606	52	G33710-0202	64
G33030-0608	52	G33710-0404	64
G33030-0806	52	G33710-0606	64
G33030-0808	52	G33710-0808	64
G33031-0508	52	G33715-0202	65
G33031-0608	52	G33715-0404	65
G33031-0708	52	G33715-0606	65
G33032-0006	52	G33715-0808	65
G33050-0006	53	G33720-0402	65
G33050-0008	53	G33720-0404	65
G33060-0006	53	G33720-0502	65
G33060-0008	53	G33720-0504	65
G33061-0006	53	G33720-0604	65
G33061-0008	53	G33720-0606	65
G33100-0604	54	G33720-0608	65
G33100-0606	54	G33720-0806	65
G33100-0608	54	G33720-0808	65
G33100-0806	54	G33730-0404	66
G33100-0808	54	G33730-0505	66
G33110-0604	54	G33730-0606	66
G33110-0606	54	G33730-0808	66
G33110-0608	54	G33730-1010	66
G33110-0806	54	G33801-0002	66
G33110-0808	54	G33801-0004	66
G33111-0604	54	G33801-0006	66
G33111-0606	54	G33801-0008	66
G33111-0608	54	G33805-0202	67

Part Number Index

Part Number	PAGE	Part Number	PAGE
G33805-0404	67	G36110-1212	84
G33805-0808	67	G36111-0402	85
G33823-1006	67	G36111-0404	85
G33830-0002	68	G36111-0406	85
G33830-0004	68	G36111-0604	85
G33830-0006	68	G36111-0606	85
G33831-0004	68	G36111-0608	85
G33832-0202	69	G36111-0808	85
G33832-0404	69	G36111-0812	85
G33832-0808	69	G36111-1012	85
G33850-0202	69	G36111-1212	85
G33850-0404	69	G36165-0404	85
G33901-0303	69	G36165-0405	85
G33901-0404	69	G36165-0406	85
G33901-0505	69	G36165-0604	85
G33901-0606	69	G36165-0605	85
G33905-0302	70	G36165-0606	85
G33905-0402	70	G36165-0608	85
G33905-0404	70	G36165-0808	85
G33905-0502	70	G36165-0810	85
G33905-0504	70	G36165-1008	85
G33905-0602	70	G36165-1010	85
G33905-0604	70	G36165-1210	85
G33910-0202	70	G36165-1212	85
G33910-0302	70	G36170-0406	86
G33910-0402	70	G36170-0606	86
G33910-0404	70	G36170-1212	86
G33910-0502	70	G36195-0404	86
G33910-0504	70	G36195-0405	86
G33910-0604	70	G36195-0406	86
G33915-0202	71	G36195-0505	86
G33915-0404	71	G36195-0604	86
G33920-0202	71	G36195-0605	86
G33920-0404	71	G36195-0606	86
G33930-0202	71	G36195-0608	86
G33930-0404	71	G36195-0808	86
G33940-0402	72	G36195-0810	86
G33940-0404	72	G36195-1008	86
G33940-0502	72	G36195-1010	86
G33940-0504	72	G36195-1210	86
G33940-0604	72	G36195-1212	86
G33945-0402	72	G36200-0406	87
G33945-0502	72	G36200-0506	87
G33945-0504	72	G36200-0606	87
G33945-0604	72	G36200-0606X	87
G33950-0404	73	G36200-0806	87
G33950-0606	73	G36200-1212	87
G36100-0402	83	G36210-0404	87
G36100-0404	83	G36210-0405	87
G36100-0406	83	G36210-0505	87
G36100-0502	83	G36210-0605	87
G36100-0504	83	G36210-0608	87
G36100-0602	83	G36210-0808	87
G36100-0604	83	G36210-0810	87
G36100-0606	83	G36210-1010	87
G36100-0608	83	G36210-1210	87
G36100-0804	83	G36500-0403	88
G36100-0806	83	G36500-0404	88
G36100-0808	83	G36500-0405	88
G36100-0812	83	G36500-0504	88
G36100-1006	83	G36500-0505	88
G36100-1008	83	G36500-0506	88
G36100-1012	83	G36500-0605	88
G36100-1208	83	G36500-0606	88
G36100-1212	83	G36500-0608	88
G36105-0404	83	G36500-0806	88
G36105-0606	83	G36500-0808	88
G36105-0808	83	G36500-1010	88
G36105-1212	83	G36508-0403	88
G36106-0402	84	G36508-0404	88
G36106-0404	84	G36508-0405	88
G36106-0502	84	G36508-0505	88
G36106-0504	84	G36508-0605	88
G36106-0602	84	G36508-0606	88
G36106-0604	84	G36508-0808	88
G36106-0606	84	G36520-0403	89
G36106-0808	84	G36520-0404	89
G36106-1212	84	G36520-0405	89
G36110-0404	84	G36520-0505	89
G36110-0504	84	G36520-0606	89
G36110-0606	84	G36520-0808	89
G36110-0806	84	G36520-1010	89
G36110-0808	84	G36535-0404	89
G36110-1008	84	G36535-0505	89

Part Number Index

Part Number	PAGE	Part Number	PAGE
G36535-0606	89	G38110-0806	96
G36535-0808	89	G38110-0808	96
G36535-0808X	89	G49001-0000	73
G36535-1010	89	G49002-0000	73
G36535-1212	89	G49003-0000	74
G36795-0504	89	G49004-0000	74
G37100-0302	91	G49005-0000	74
G37100-0402	91	G49006-0000	74
G37100-0404	91	G49007-0000	74
G37100-0502	91	G49008-0000	75
G37100-0504	91	G49009-0000	75
G37100-0602	91	G49010-0000	75
G37100-0604	91	G49011-0000	76
G37100-0606	91	G49012-0000	76
G37100-0806	91	G49013-0000	76
G37100-0808	91	G49014-0000	76
G37100-1006	91	G49015-0000	77
G37100-1008	91	G49016-0000	77
G37100-1012	91	G49017-0000	77
G37100-1208	91	G49018-0000	78
G37100-1212	91	G49129-0004	78
G37103-0609	91	G49130-0002	78
G37103-0610	91	G49130-0004	78
G37103-0614	91	G49130-0006	78
G37106-0402	92	G49134-0002	79
G37106-0502	92	G49135-0002	79
G37106-0504	92	G49136-0002	80
G37106-0602	92	G49136-0004	80
G37106-0604	92	G49136-0006	80
G37106-0606	92	G49137-0002	80
G37106-0806	92	G49137-0004	80
G37106-0808	92	G49138-0604	80
G37106-1006	92	G49140-0002	81
G37106-1008	92	G49140-0004	81
G37106-1208	92	G49140-0006	81
G37195-0605	92	G49140-0008	81
G37195-0606	92	G49200-1612	106
G37500-0404	92	G49230-0404	106
G37500-0405	93	G49240-0204	106
G37500-0504	93	G49250-0205	107
G37500-0505	93	G49251-0514	107
G37500-0506	93	G49251-0614	107
G37500-0605	93	G49255-0402	81
G37500-0606	93	G49300-0303	107
G37503-0605	93	G49300-0305	107
G37504-0404	93	G49300-0403	107
G37504-0405	93	G49300-0404	107
G37504-0506	93	G49301-0303	107
G37504-0605	93	G49301-0304	107
G37504-0606	93	G49301-0403	107
G37508-0505	94	G49302-0303	107
G37508-0605	94	G49303-0403	107
G37508-0606	94	G49304-1203	108
G38100-0202	96	G49304-1303	108
G38100-0302	96	G49305-1203	108
G38100-0304	96	G49310-0303	108
G38100-0402	96	G49310-0404	108
G38100-0404	96	G49312-0304	108
G38100-0406	96	G49313-0004	108
G38100-0502	96	G49314-0306	109
G38100-0504	96	G49320-1003	109
G38100-0602	96	G49321-1003	109
G38100-0604	96	G49321-1110	109
G38100-0606	96	G49321-1210	109
G38100-0608	96	G49321-1310	109
G38100-0804	96	G49323-0310	110
G38100-0806	96	G49324-0304	110
G38100-0808	96	G49325-1103	110
G38100-0812	96	G49325-1203	110
G38100-1006	96	G49325-1303	110
G38100-1008	96	G49326-1003	111
G38100-1012	96	G49375-0204	98
G38100-1208	96	G49400-1010	111
G38100-1212	96	G49401-0303	111
G38110-0202	96	G49402-1010	112
G38110-0302	96	G49403-1010	112
G38110-0402	96	G49500-0304	112
G38110-0404	96	G49500-0405	112
G38110-0502	96	G49500-0503	112
G38110-0504	96	G49500-0504	112
G38110-0602	96	G49500-0506	112
G38110-0604	96	G49500-0605	112
G38110-0606	96	G49501-0303	112
G38110-0804	96	G49501-0404	112

Part Number Index

Part Number	PAGE	Part Number	PAGE
G49501-0503	112	G55104-0302	118
G49502-0303	112	G55104-0402	118
G49502-0503	112	G55104-0404	118
G49503-0303	112	G55104-0502	118
G49504-0303	112	G55104-0504	118
G49505-0403	112	G55104-0602	118
G49505-0404	112	G55104-0604	118
G49505-0503	112	G55104-0606	118
G49505-0504	113	G55104-0608	118
G49505-0505	113	G55104-0704	118
G49506-0605	113	G55104-0804	118
G49507-0303	113	G55104-0806	119
G49507-0503	113	G55104-0808	119
G49700-0504	113	G55104-1008	119
G49700-0606	113	G55104-1208	119
G49701-0406	113	G55104-1212	119
G49702-1406	113	G55130-0203	119
G49702-1606	114	G55130-0204	119
G49702-1806	114	G55130-0205	119
G49800-0505	114	G55130-0404	119
G49800-0606	114	G55130-0406	119
G49900-0404	114	G55130-0608	119
G49901-0605	114	G55134-0302	119
G49901-0607	114	G55134-0402	119
G55028-0302	116	G55134-0404	119
G55028-0402	116	G55134-0502	119
G55028-0502	116	G55134-0604	119
G55028-0604	116	G55134-0806	119
G55030-0003	116	G55150-0202	120
G55030-0004	116	G55150-0302	120
G55030-0005	116	G55150-0402	120
G55030-0006	116	G55150-0404	120
G55030-0008	116	G55150-0502	120
G55030-0010	116	G55150-0504	120
G55030-0012	116	G55150-0602	120
G55030-0016	116	G55150-0604	120
G55040-0004	116	G55150-0806	120
G55040-0004T	116	G55150-1008	120
G55040-0005	116	G55154-0302	120
G55040-0006	116	G55154-0402	120
G55040-0008	116	G55154-0502	120
G55040-0010	116	G55154-0604	120
G55040-0012	116	G55154-0806	120
G55040-0016	116	G55154-1008	120
G55050-0002	117	G55161-0203	121
G55050-0003	117	G55161-0204	121
G55050-0004	117	G55300-0404	121
G55050-0005	117	G55300-0505	121
G55050-0006	117	G55300-0606	121
G55050-0007	117	G55300-0808	121
G55050-0008	117	G55400-0202	121
G55050-0010	117	G55400-0303	121
G55050-0012	117	G55400-0404	121
G55050-0016	117	G55400-0505	121
G55060-0002	117	G55400-0606	121
G55060-0003	117	G55400-0808	121
G55060-0004	117	G55400-1010	121
G55060-0005	117	G55400-1212	121
G55060-0006	117	G55404-0303	122
G55060-0007	117	G55404-0404	122
G55060-0008	117	G55404-0505	122
G55060-0010	117	G55404-0606	122
G55060-0012	117	G55404-0808	122
G55100-0201	118	G55450-0303	122
G55100-0202	118	G55450-0404	122
G55100-0302	118	G55450-0505	122
G55100-0304	118	G55450-0606	122
G55100-0402	118	G55450-0808	122
G55100-0404	118	G56050-0004	124
G55100-0502	118	G56050-0005	124
G55100-0504	118	G56050-0006	124
G55100-0602	118	G56050-0008	124
G55100-0604	118	G56050-0010	124
G55100-0606	118	G56050-0025	124
G55100-0608	118	G56099-0002	124
G55100-0704	118	G56099-0004	124
G55100-0804	118	G56099-0005	124
G55100-0806	118	G56099-0006	124
G55100-0808	118	G56099-0008	124
G55100-1008	118	G56100-0202	124
G55100-1208	118	G56100-0204	124
G55100-1212	118	G56100-0402	124
G55104-0201	118	G56100-0404	124
G55104-0202	118	G56100-0406	124

Part Number Index

Part Number	PAGE	Part Number	PAGE
G56100-0502	124	G56450-0606	129
G56100-0504	124	G56450-0808	129
G56100-0506	124	G56450-1212	129
G56100-0602	124	G56450-2525	129
G56100-0604	124	G56975-0202	41
G56100-0606	125	G56975-0404	41
G56100-0608	125	G56975-2525	41
G56100-0806	125	G56978-0202	41
G56100-0808	125	G56978-0204	41
G56100-2502	125	G57050-0004	131
G56100-2504	125	G57050-0006	131
G56104-0402	125	G57050-0008	131
G56104-0404	125	G57100-0401	131
G56104-0604	125	G57100-0402	131
G56104-0606	125	G57100-0404	131
G56124-0202	125	G57100-0602	131
G56124-0204	125	G57100-0604	131
G56124-0402	125	G57100-0608	131
G56124-0404	125	G57100-0806	131
G56124-0406	125	G57100-2502	131
G56124-0502	125	G57104-0401	131
G56124-0504	125	G57104-0402	131
G56124-0506	125	G57104-0404	131
G56124-0602	125	G57104-0602	131
G56124-0604	125	G57104-0604	131
G56124-0606	125	G57104-0806	131
G56124-0608	125	G57130-0204	132
G56124-0804	126	G57130-0206	132
G56124-0806	126	G57130-0402	132
G56124-0808	126	G57130-0602	132
G56124-2502	126	G57130-0604	132
G56140-0402	126	G57150-0402	132
G56140-0404	126	G57150-0404	132
G56140-0604	126	G57154-0402	132
G56140-0606	126	G57154-0604	132
G56140-0806	126	G57160-0402	133
G56140-0808	126	G57190-0304	133
G56142-0202	126	G57190-0404	133
G56142-0402	126	G57300-0404	133
G56142-0404	126	G57300-0606	133
G56142-0604	126	G57300-0808	133
G56142-0606	126	G57350-0404	133
G56142-0608	126	G57350-0606	134
G56142-0804	126	G57400-0304	134
G56142-0806	126	G57400-0404	134
G56142-0808	126	G57400-0406	134
G56142-2502	126	G57400-0606	134
G56150-0202	127	G57400-0804	134
G56150-0204	127	G57400-0806	134
G56150-0402	127	G57400-0808	134
G56150-0404	127	G57401-0404	134
G56150-0604	127	G57404-0404	134
G56150-0606	127	G57404-0606	134
G56300-0202	127	G57404-0808	134
G56300-0404	127	G57452-0404	135
G56300-0606	127	G57452-0604	135
G56300-0808	127	G57452-0606	135
G56400-0202	127	G57452-0608	135
G56400-0204	127	G57452-0804	135
G56400-0404	127	G57452-0806	135
G56400-0406	127	G57452-0808	135
G56400-0505	127	G58050-0002	137
G56400-0606	127	G58050-0003	137
G56400-0608	127	G58050-0004	137
G56400-0808	127	G58050-0005	137
G56400-1010	127	G58050-0006	137
G56400-1212	127	G58050-0008	137
G56400-2504	127	G58050-0010	137
G56400-2525	127	G58050-0012	137
G56402-0202	128	G58050-0016	137
G56402-0404	128	G58060-0002	137
G56402-0505	128	G58060-0003	137
G56402-0606	128	G58060-0004	137
G56402-0808	128	G58060-0005	137
G56402-2525	128	G58060-0006	137
G56404-0202	128	G58060-0008	137
G56404-0404	128	G58060-0010	137
G56404-0505	128	G58100-0201	138
G56404-0606	128	G58100-0202	138
G56404-0808	128	G58100-0302	138
G56404-2525	128	G58100-0304	138
G56450-0202	128	G58100-0402	138
G56450-0404	128	G58100-0404	138
G56450-0505	129	G58100-0502	138

Part Number Index

Part Number	PAGE	Part Number	PAGE
G58100-0504.....	138	G60604-0002.....	143
G58100-0604.....	138	G60604-0004.....	143
G58100-0606.....	138	G60604-0006.....	143
G58100-0608.....	138	G60605-0101.....	143
G58100-1212.....	138	G60605-0102.....	143
G58104-0201.....	138	G60605-0202.....	143
G58104-0202.....	138	G60605-0204.....	143
G58104-0302.....	138	G60605-0206.....	143
G58104-0402.....	138	G60605-0404.....	143
G58104-0404.....	138	G60605-0406.....	143
G58104-0604.....	138	G60605-0408.....	143
G58104-0606.....	138	G60605-0606.....	143
G58104-0608.....	138	G60605-0608.....	143
G58104-0808.....	138	G60605-0808.....	143
G58104-1008.....	138	G60605-0812.....	143
G58134-0402.....	139	G60605-1212.....	143
G58134-0604.....	139	G60606-0202.....	144
G58134-0806.....	139	G60606-0404.....	144
G58150-0202.....	139	G60606-0606.....	144
G58150-0402.....	139	G60606-0808.....	144
G58150-0604.....	139	G60606-1212.....	144
G58400-0202.....	139	G60607-0202.....	144
G58400-0303.....	139	G60607-0404.....	144
G58400-0404.....	139	G60607-0606.....	144
G58400-0505.....	139	G60608-0202.....	144
G58400-0606.....	139	G60608-0404.....	144
G58400-0808.....	139	G60608-0606.....	144
G58400-1010.....	139	G60608-0808.....	144
G60593-0202.....	165	G60608-1212.....	144
G60593-0303.....	165	G60610-0202.....	145
G60593-0404.....	165	G60610-0204.....	145
G60593-0505.....	165	G60610-0206.....	145
G60593-0606.....	165	G60610-0404.....	145
G60594-0202.....	165	G60610-0406.....	145
G60594-0302.....	165	G60610-0606.....	145
G60594-0402.....	165	G60610-0608.....	145
G60594-0502.....	165	G60610-0808.....	145
G60594-0604.....	165	G60612-0202.....	145
G60595-0202.....	165	G60612-0404.....	145
G60595-0221.....	165	G60612-0606.....	145
G60595-0302.....	165	G60612-0808.....	145
G60595-0402.....	165	G60612-1212.....	145
G60595-0502.....	165	G60614-0402.....	146
G60595-0604.....	166	G60614-0602.....	146
G60596-0202.....	98	G60614-0604.....	146
G60596-0303.....	98	G60614-0802.....	146
G60596-0404.....	98	G60614-0804.....	146
G60596-0505.....	98	G60614-0806.....	146
G60596-0606.....	98	G60614-1206.....	146
G60596-0607.....	98	G60614-1208.....	146
G60596-0707.....	98	G60615-0102.....	146
G60596-0808.....	98	G60615-0202.....	146
G60596-1010.....	98	G60615-0204.....	146
G60596-1212.....	98	G60615-0206.....	146
G60596-1414.....	98	G60615-0404.....	146
G60596-1616.....	98	G60615-0406.....	146
G60597-0303.....	98	G60615-0408.....	146
G60597-0404.....	98	G60615-0606.....	146
G60599-0303.....	99	G60615-0608.....	146
G60599-0404.....	99	G60615-0808.....	146
G60599-0505.....	99	G60615-0812.....	146
G60599-0606.....	99	G60615-1212.....	146
G60599-0808.....	99	G60618-0202.....	147
G60600-0002.....	141	G60618-0404.....	147
G60600-0004.....	141	G60618-0606.....	147
G60600-0006.....	141	G60618-0808.....	147
G60600-0008.....	141	G60618-1212.....	147
G60600-0012.....	141	G60620-0101.....	147
G60601-0001.....	142	G60620-0202.....	147
G60601-0002.....	142	G60620-0204.....	147
G60601-0004.....	142	G60620-0402.....	147
G60601-0006.....	142	G60620-0404.....	147
G60601-0008.....	142	G60620-0406.....	147
G60601-0012.....	142	G60620-0604.....	147
G60602-0002.....	142	G60620-0606.....	147
G60602-0004.....	142	G60620-0608.....	147
G60602-0006.....	142	G60620-0806.....	147
G60602-0008.....	142	G60620-0808.....	147
G60602-0012.....	142	G60620-1212.....	147
G60603-0001.....	142	G60623-0203.....	148
G60603-0002.....	142	G60625-0202.....	99
G60603-0004.....	143	G60625-0203.....	99
G60603-0006.....	143	G60625-0204.....	99
G60603-0008.....	143	G60625-0205.....	99

Part Number Index

Part Number	PAGE	Part Number	PAGE
G60625-0206	99	G60637-0204	150
G60625-0404	99	G60637-0404	150
G60625-0405	99	G60637-0406	150
G60625-0406	99	G60637-0606	150
G60625-0408	99	G60637-0608	150
G60625-0606	99	G60637-0808	150
G60625-0607	99	G60637-1212	150
G60625-0608	99	G60639-0202	150
G60625-0808	99	G60639-0404	150
G60625-0810	99	G60639-0606	150
G60625-0812	99	G60639-0808	150
G60625-1212	99	G60639-1212	150
G60625-1214	99	G60640-0101	151
G60625-1616	99	G60640-0202	151
G60626-0202	100	G60640-0204	151
G60626-0203	100	G60640-0402	151
G60626-0204	100	G60640-0404	151
G60626-0205	100	G60640-0604	151
G60626-0206	100	G60640-0606	151
G60626-0405	100	G60640-0806	151
G60626-0406	100	G60640-0808	151
G60626-0608	100	G60640-1208	151
G60626-0810	100	G60640-1212	151
G60627-0202	100	G60641-0202	151
G60627-0203	100	G60641-0404	151
G60627-0204	100	G60641-0606	151
G60627-0205	100	G60641-0808	151
G60627-0206	100	G60641-1212	151
G60627-0404	100	G60642-0202	152
G60627-0405	100	G60642-0404	152
G60627-0406	100	G60642-0606	152
G60627-0408	100	G60642-0808	152
G60627-0605	100	G60642-1212	152
G60627-0606	100	G60643-0003	154
G60627-0608	100	G60643-0004	154
G60627-0610	100	G60643-0005	154
G60627-0808	100	G60643-0006	154
G60627-0810	100	G60643-0008	154
G60627-0812	100	G60643-0010	154
G60627-1212	100	G60643-0012	154
G60627-1214	100	G60644-0002	154
G60627-1616	100	G60644-0003	154
G60628-0302	101	G60644-0004	154
G60628-0402	101	G60644-0005	154
G60628-0504	101	G60644-0006	154
G60628-0604	101	G60644-0008	154
G60629-0203	101	G60644-0010	154
G60629-0204	101	G60644-0012	154
G60629-0205	101	G60645-0202	154
G60629-0406	101	G60645-0303	155
G60629-0408	101	G60645-0403	155
G60630-0202	101	G60645-0404	155
G60630-0203	101	G60645-0504	155
G60630-0204	101	G60645-0505	155
G60630-0205	101	G60645-0604	155
G60630-0404	101	G60645-0605	155
G60630-0406	102	G60645-0606	155
G60630-0407	102	G60645-0804	155
G60630-0608	102	G60645-0806	155
G60630-0810	102	G60645-0808	155
G60630-0812	102	G60645-1006	155
G60631-0101	148	G60645-1008	155
G60631-0202	148	G60645-1010	155
G60631-0402	148	G60645-1208	155
G60631-0404	148	G60645-1210	155
G60631-0602	148	G60645-1212	155
G60631-0604	148	G60648-0202	155
G60631-0606	148	G60648-0404	155
G60631-0806	148	G60648-0505	155
G60631-0808	148	G60648-0604	155
G60631-1208	148	G60648-0605	155
G60631-1212	148	G60648-0606	155
G60632-0202	148	G60648-0804	155
G60632-0404	148	G60648-0806	155
G60632-0606	148	G60648-0808	155
G60632-0808	148	G60648-1006	155
G60632-1212	149	G60648-1008	155
G60633-0202	149	G60648-1010	155
G60635-0202	149	G60648-1210	155
G60635-0404	149	G60648-1212	155
G60635-0606	149	G60650-0202	156
G60635-0808	149	G60650-0302	156
G60635-1212	149	G60650-0402	156
G60637-0202	150	G60650-0404	156

Part Number Index

Part Number	PAGE	Part Number	PAGE
G60650-0406	156	G60659-0606	159
G60650-0408	156	G60659-0608	159
G60650-0502	156	G60659-0610	159
G60650-0504	156	G60659-0806	159
G60650-0506	156	G60659-0808	159
G60650-0602	156	G60659-0810	159
G60650-0604	156	G60659-0812	159
G60650-0606	156	G60659-1212	159
G60650-0608	156	G60660-0202	159
G60650-0704	156	G60660-0302	159
G60650-0804	156	G60660-0402	159
G60650-0806	156	G60660-0404	159
G60650-0808	156	G60660-0406	159
G60650-0812	156	G60660-0408	159
G60650-1006	156	G60660-0502	159
G60650-1008	156	G60660-0504	159
G60650-1012	156	G60660-0506	159
G60650-1208	156	G60660-0602	159
G60650-1212	156	G60660-0604	159
G60652-0402	156	G60660-0606	159
G60652-0404	156	G60660-0608	159
G60652-0502	156	G60660-0804	159
G60652-0504	156	G60660-0806	159
G60652-0604	156	G60660-0808	159
G60652-0606	156	G60660-1006	159
G60652-0608	156	G60660-1008	159
G60652-0806	156	G60660-1012	159
G60652-0808	156	G60660-1208	159
G60652-1006	157	G60664-0302	160
G60652-1008	157	G60664-0402	160
G60652-1208	157	G60664-0404	160
G60652-1212	157	G60664-0406	160
G60654-0202	157	G60664-0502	160
G60654-0302	157	G60664-0504	160
G60654-0402	157	G60664-0604	160
G60654-0404	157	G60664-0606	160
G60654-0406	157	G60664-0806	160
G60654-0502	157	G60664-0808	160
G60654-0504	157	G60664-1006	160
G60654-0506	157	G60664-1008	160
G60654-0602	157	G60664-1208	160
G60654-0604	157	G60664-1212	160
G60654-0606	157	G60669-0202	160
G60654-0607	157	G60669-0303	160
G60654-0608	157	G60669-0404	160
G60654-0612	157	G60669-0406	160
G60654-0804	157	G60669-0504	160
G60654-0806	157	G60669-0505	160
G60654-0808	157	G60669-0604	160
G60654-0812	157	G60669-0606	160
G60654-1006	157	G60669-0608	160
G60654-1008	157	G60669-0610	160
G60654-1012	157	G60669-0804	160
G60654-1208	157	G60669-0806	160
G60654-1212	157	G60669-0808	160
G60657-0202	158	G60669-0810	160
G60657-0302	158	G60669-0812	161
G60657-0402	158	G60669-1004	161
G60657-0404	158	G60669-1006	161
G60657-0406	158	G60669-1008	161
G60657-0408	158	G60669-1010	161
G60657-0502	158	G60669-1208	161
G60657-0504	158	G60669-1210	161
G60657-0602	158	G60669-1212	161
G60657-0604	158	G60670-0604	161
G60657-0606	158	G60670-0806	161
G60657-0608	158	G60670-1006	161
G60657-0804	158	G60670-1008	161
G60657-0806	158	G60671-0604	161
G60657-0808	158	G60671-0804	161
G60657-0812	158	G60671-0806	161
G60657-1008	158	G60671-1006	161
G60657-1012	158	G60671-1008	161
G60657-1208	158	G60671-1210	161
G60657-1212	158	G60675-0002	161
G60659-0203	158	G60675-0003	161
G60659-0204	158	G60675-0004	161
G60659-0205	158	G60675-0005	161
G60659-0206	158	G60675-0006	161
G60659-0404	158	G60675-0007	161
G60659-0405	158	G60675-0008	161
G60659-0406	158	G60675-0010	161
G60659-0408	158	G60675-0012	161
G60659-0604	159	G60676-0003	162

Part Number Index

Part Number	PAGE	Part Number	PAGE
G60676-0004.....	162	H30060-04.....	19
G60676-0005.....	162	H30060-06.....	19
G60676-0006.....	162	H30061-04.....	19
G60676-0008.....	162	H30062-04.....	19
G60676-0010.....	162	H30062-06.....	19
G60679-0403.....	114	H30062-08.....	19
G60679-0404.....	114	H30063-10.....	19
G60680-0404.....	162	H30063-12.....	19
G60680-0505.....	162	H30065-06.....	19
G60680-0606.....	162	H30065-08.....	19
G60680-0808.....	162	H30070-04.....	19
G60690-0204.....	163	H30070-06.....	19
G60690-0402.....	163	H30072-04.....	19
G60690-0502.....	163	H30072-06.....	19
G60690-0604.....	163	H30072-08.....	19
G60691-0003.....	102	H30073-10.....	19
G60691-0004.....	102	H30073-12.....	19
G60691-0005.....	102	H30080-06.....	19
G60691-0006.....	102	H30080-10.....	19
G60693-0202.....	102	H30082-04.....	19
G60693-0303.....	102	H30082-06.....	19
G60693-0404.....	102	H30082-08.....	19
G60693-0505.....	102	H30083-10.....	19
G60693-0606.....	102	H30083-12.....	19
G60693-0808.....	102	H30090-04.....	19
G60693-1010.....	102	H30090-08.....	19
G60694-0404.....	103		
G60694-0505.....	103		
G60694-0606.....	103		
G60694-0808.....	103		
G60695-0202.....	103		
G60695-0303.....	103		
G60695-0404.....	103		
G60695-0505.....	103		
G60695-0606.....	103		
G60695-0808.....	103		
G60695-1414.....	103		
G60696-0303.....	104		
G60696-0402.....	104		
G60696-0404.....	104		
G60696-0505.....	104		
G60696-0604.....	104		
G60696-0808.....	104		
H30000-02.....	18		
H30000-04.....	18		
H30000-05.....	18		
H30000-06.....	18		
H30000-08.....	18		
H30000-10.....	18		
H30000-12.....	18		
H30002-02.....	18		
H30002-03.....	18		
H30002-04.....	18		
H30002-05.....	18		
H30002-06.....	18		
H30002-08.....	18		
H30002-25.....	18		
H30003-10.....	18		
H30003-12.....	18		
H30005-06.....	18		
H30010-04.....	18		
H30010-06.....	18		
H30020-06.....	18		
H30030-04.....	18		
H30040-04.....	18		
H30040-06.....	18		
H30040-10.....	18		
H30042-04.....	18		
H30042-06.....	18		
H30042-08.....	18		
H30043-10.....	18		
H30043-12.....	18		
H30045-06.....	18		
H30045-08.....	18		
H30050-04.....	18		
H30050-06.....	18		
H30050-10.....	18		
H30052-04.....	18		
H30052-06.....	18		
H30052-08.....	18		
H30053-10.....	18		
H30053-12.....	18		
H30055-06.....	18		
H30055-08.....	18		

Coupling Cabinets

Customized to fit all your needs

Now even more versatile, these easy-to-assemble units are compactly designed to give you years of reliable service. Components are ordered individually by part/product number for easy customization.

**Great
for
Brass**

1. Mounting Shelf

Part No. 78193

Product No. 7484-0013

2. Coupling Cabinet with Four Sliding Shelves [2 Shown]

Part No. 78190

Product No. 7484-0010

Shelves slide out for easy access and can hold a combination of ten 3 1/2" wide bin boxes or five 7" wide bin boxes. Unit can be stacked and bolted together as shown in image. Each measures 41" wide x 21" high x 12" deep.

Safety Hint:

Slide open only one shelf at a time to avoid tipping

3. Stationary Legs [Shown]

Part No. 78191

Product No. 7484-0011

Allows for precise leveling.

4. Bin Boxes

Ordered separately in whatever combination best fits your needs. Four dividers come with each bin box. Each bin box has nine available slots, which allows for maximum utilization.

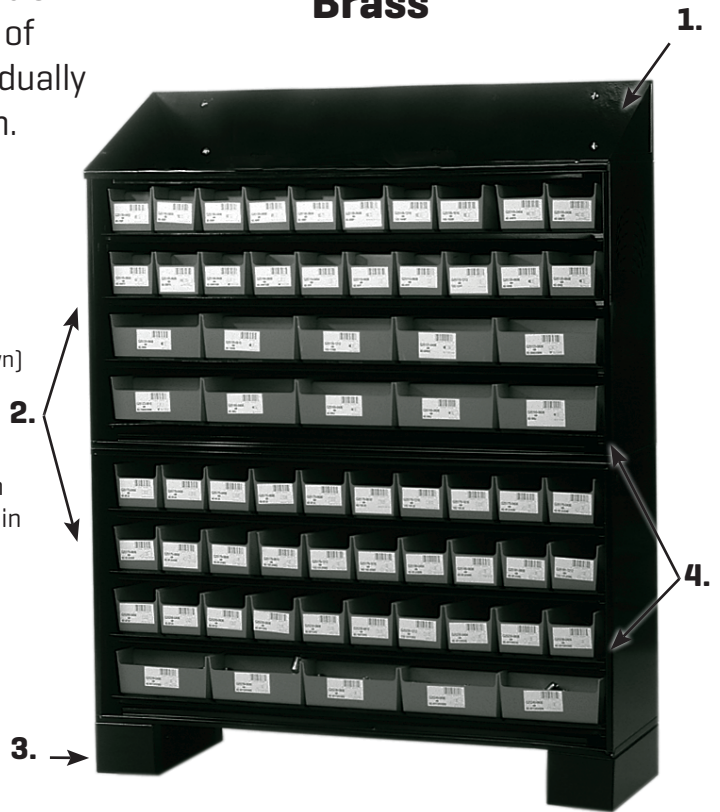

When assembled, the typical combination of two 4-shelf coupling cabinets and stationary leg set as shown measures 48" high x 41" wide x 12" deep.

Description	Part No.	Product No.
Ten 3.5" wide bins with three dividers each	78194	7484-0014
Five 7" wide bins with three dividers each	78195	7484-0015
Three dividers for 3.5" wide bin box	78196	7484-0016
Three dividers for 7" wide bin box	78197	7484-0017
Sixty dividers for 3.5" wide bin box	78199	7484-0031

2-Drawer Coupling Cabinet

Part No. 78189

Product No. 7484-0021

This two-drawer cabinet is ideal to add nylon air brake tubing couplings to your inventory. This cabinet can be stacked and bolted together with your existing cabinet. Uses the same bin boxes as above. Measures 41" wide x 11" high x 12" deep.





POWERING PROGRESS™



GATES CORPORATION - WORLD HEADQUARTERS

Denver, Colorado 80202, U.S.A.
303.744.1911 / Fax 303.744.4499
Gates.com

July 2017
 Please recycle this catalog!
Printed in the U.S.A.