

 **Timo** Altti 618/619/611

Instruction

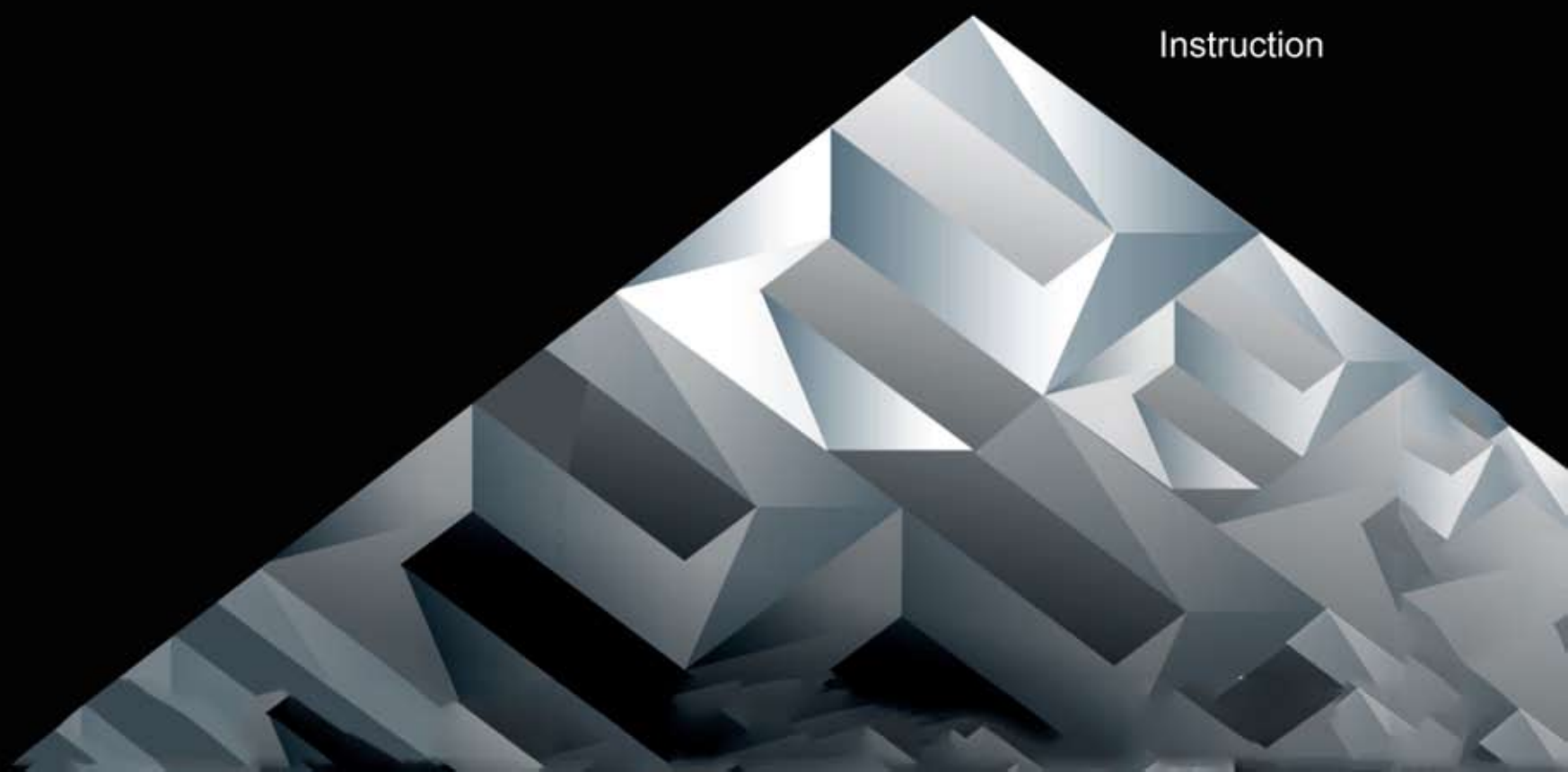

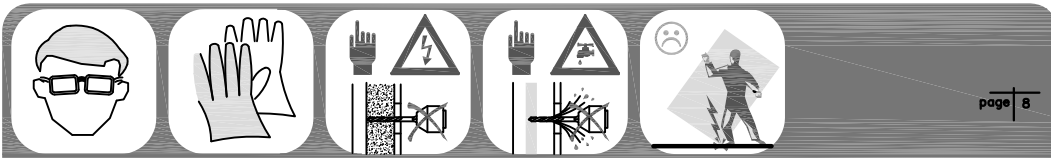

CARE INSTRUCTIONS

Shower enclosures should be cleaned after every use. To prevent limescale from building up, use a squeegee, a soft cloth or chamois leather-but no cleaning-to wipe off any water droplets left after showering. Residue left by bodycare products (liquid soap, shampoo, shower gel) can also cause substances to accumulate. Use water to rinse away residues after use. All sliding door track fittings should also be cleaned this way-to ensure that they continue run smoothly.

- **Don't allow limescale to build up-especially in hard water areas**
- **If you do get a stubborn limescale build up, a mixture of 50:50 vinegar and water will help you to clean it away-but make sure all vinegar is rinsed off completely**
Never use strong detergents or cleaning agents
Cleaning materials should wherever possible be rated between PH4 and PH8
In no circumstances should you use any abrasive substance

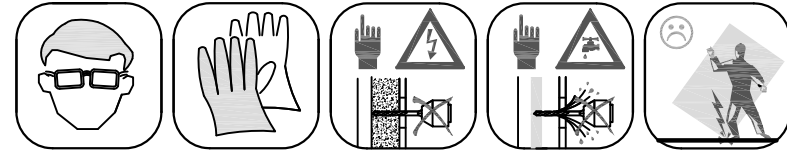

We appreciate your choosing of our shower products, and wish you a pleasant experience with our products and service. Please read Instruction carefully before installation.

IMPORTANT

Please check the shower enclosure for transport damage and completeness before installation. Complaints made following installation cannot be accepted.

Please read carefully the following instructions before installing your shower enclosure to ensure safe and proper use and avoid any injury to either the installer or user. Failure to comply may invalidate your guarantee.

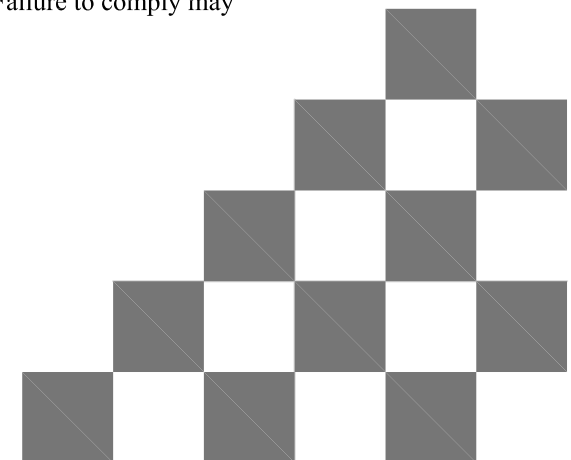
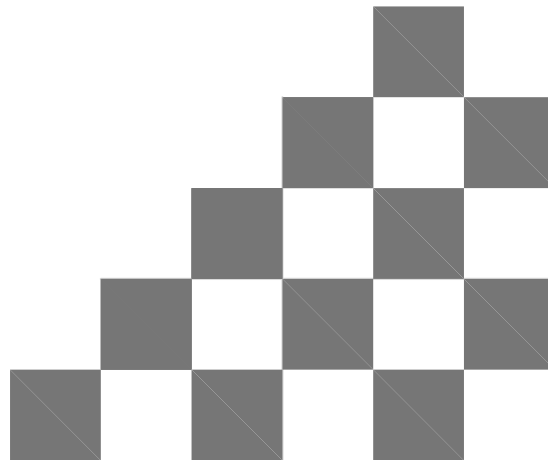

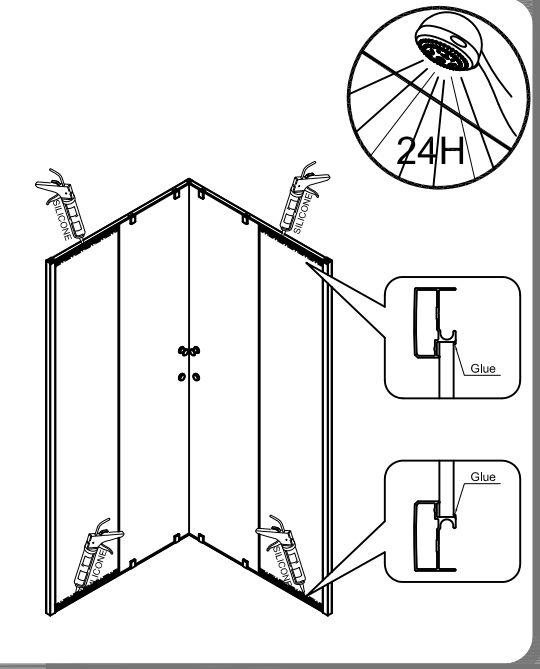
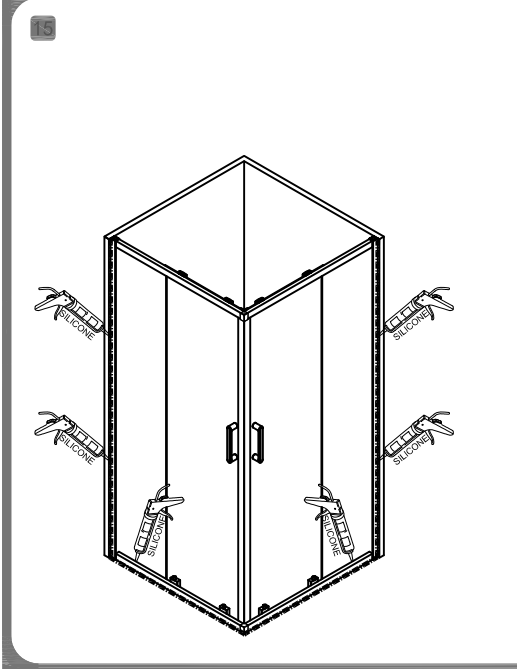
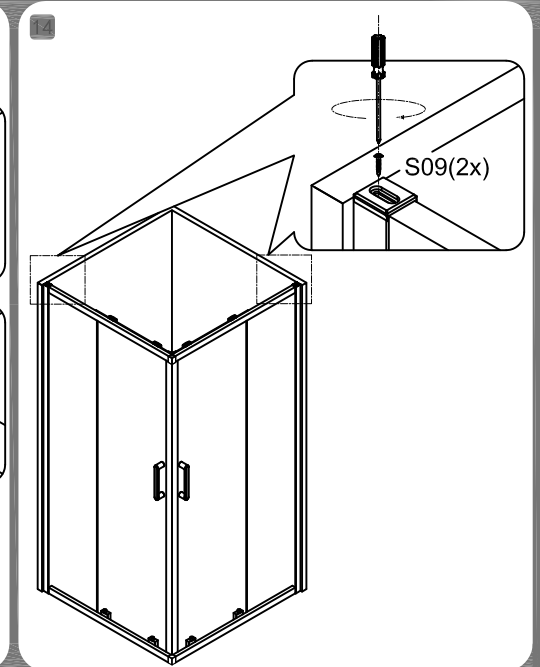
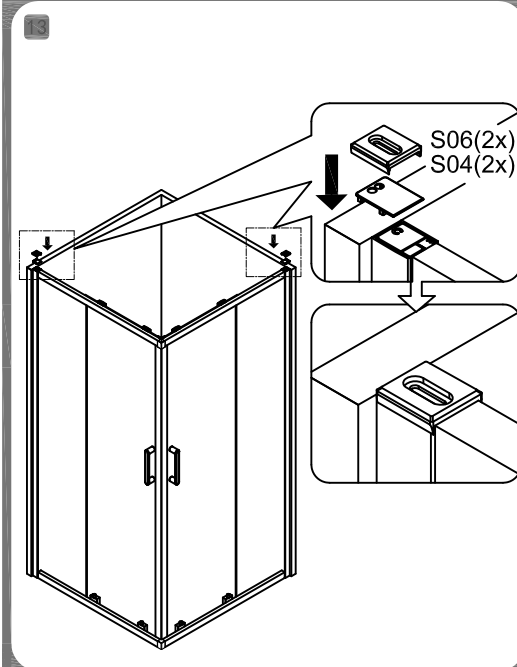
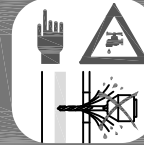
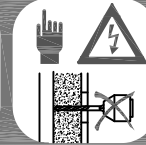
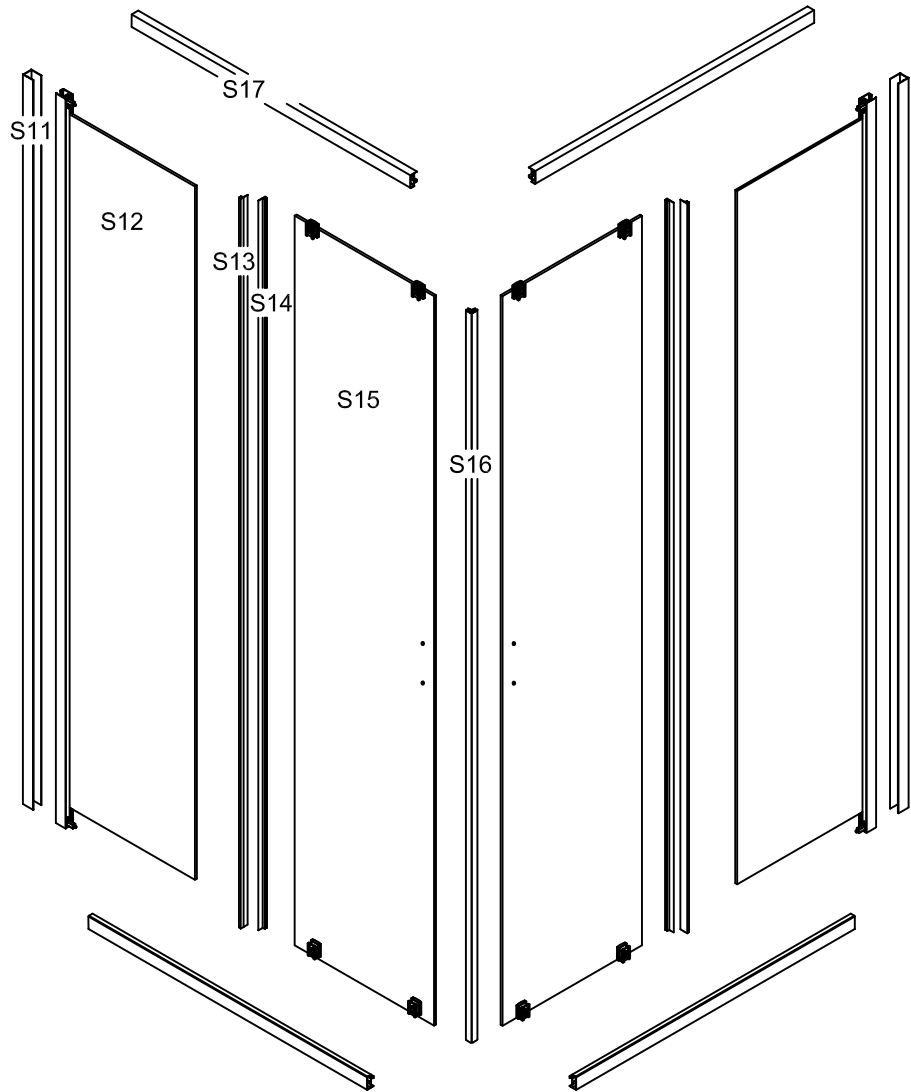

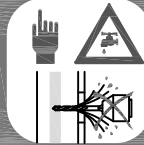
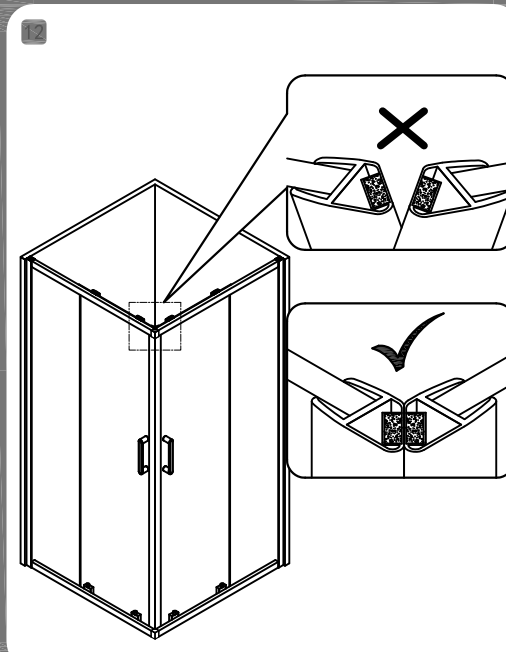
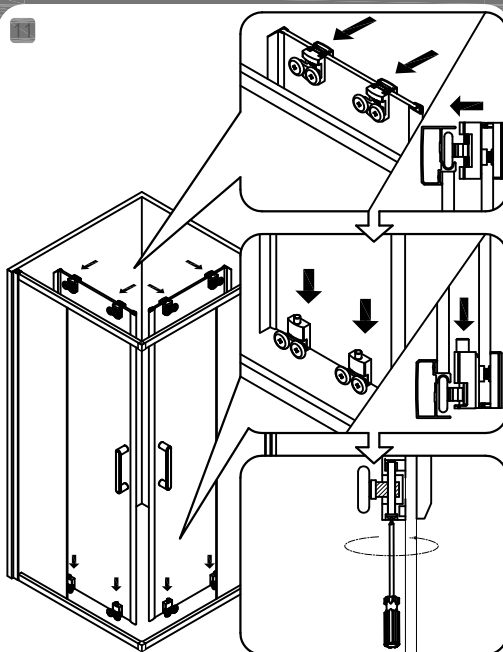
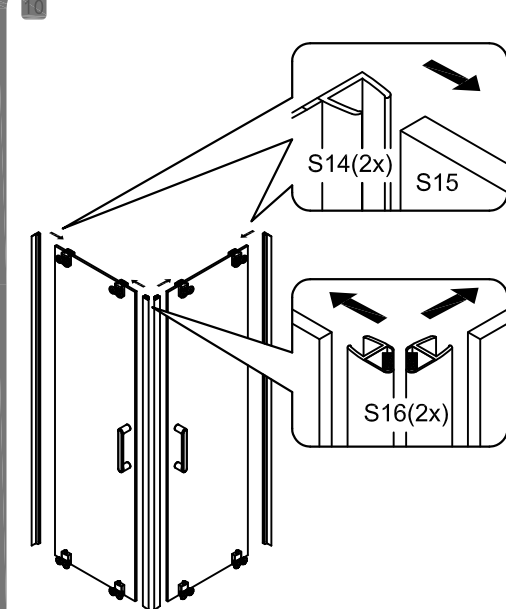
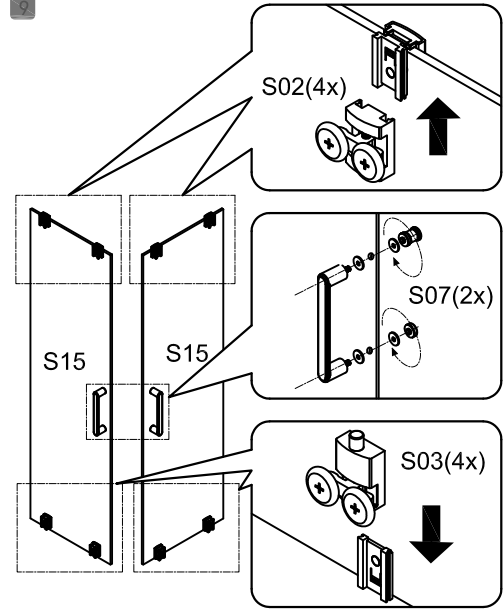
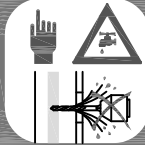
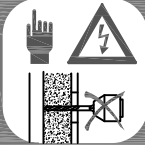

S01 4x	S02 4x	S03 4x	S04 1x	S05 1x	S06 2x	S07 2x	S08 6x	S09 2x	S10 6x

