



# Metal Seal Design Guide

High Performance Engineered  
Seals and Sealing Systems



ENGINEERING YOUR SUCCESS.



#### **WARNING – USER RESPONSIBILITY**

FAILURE OR IMPROPER SELECTION OR IMPROPER USE OF THE PRODUCTS DESCRIBED HEREIN OR RELATED ITEMS CAN CAUSE DEATH, PERSONAL INJURY AND PROPERTY DAMAGE.

This document and other information from Parker-Hannifin Corporation, its subsidiaries and authorized distributors provide product or system options for further investigation by users having technical expertise.

The user, through its own analysis and testing, is solely responsible for making the final selection of the system and components and assuring that all performance, endurance, maintenance, safety and warning requirements of the application are met. The user must analyze all aspects of the application, follow applicable industry standards, and follow the information concerning the product in the current product catalog and in any other materials provided from Parker or its subsidiaries or authorized distributors.

To the extent that Parker or its subsidiaries or authorized distributors provide component or system options based upon data or specifications provided by the user, the user is responsible for determining that such data and specifications are suitable and sufficient for all applications and reasonably foreseeable uses of the components or systems.

#### **OFFER OF SALE**

The items described in this document are hereby offered for sale by Parker-Hannifin Corporation, its subsidiaries or its authorized distributors. This offer and its acceptance are governed by the provisions stated in the detailed "Offer of Sale" elsewhere in this document or available at [www.parker.com/salesterms/](http://www.parker.com/salesterms/).

# Metal Seal Design Guide Table of Contents

<b>Introduction</b> .....	4	Temperature Capabilities – Other Materials.....	D-55
<b>Section A – General Metal Seal Information</b>		Aerospace Material Specification (AMS) Reference.....	D-56
Advantages of Metal Seals .....	A-8	Yield Strength, Relaxation & Springback .....	D-56
How to Use the Metal Seal Design Guide .....	A-9	<b>Metal Seal, Platings, Coatings and Finishes</b>	
Market Applications .....	A-10	Temper Codes.....	D-58
<b>Section B – Metal Seal Type Selection</b>		Finish Codes.....	D-59
Selecting the Metal Seal Type for Your Application .....	B-11	Finish Thickness Selecting Guidelines.....	D-60
Seal Selection at a Glance.....	B-14	Silver-Indium Plating.....	D-61
<b>Section C – Metal Seal Size Selection</b>		TriCom® Plating .....	D-62
<b>Face Seals</b>		TriCom-HT™ Plating.....	D-64
<b>ECI</b> Metal C-Ring, Internal Pressure Face Seal .....	C-16	<b>Section E – Technical Information Performance Data</b>	
<b>ECE</b> Metal C-Ring, External Pressure Face Seal.....	C-18	Load, Deflection and Springback / Terminology .....	E-68
<b>ESI</b> Spring Energized Metal C-Ring, Internal Pressure Face Seal .....	C-20	Metal C-Ring Performance.....	E-70
<b>ESE</b> Spring Energized Metal C-Ring, External Pressure Face Seal .....	C-22	Metal E-Ring Performance.....	E-72
<b>E EI</b> Metal E-Ring, Internal Pressure Face Seal .....	C-24	Metal U-Ring Performance.....	E-73
<b>EEE</b> Metal E-Ring, External Pressure Face Seal.....	C-26	Metal O-Ring Performance .....	E-74
<b>EOI</b> Metal O-Ring, I.D. Vented, Internal Pressure Face Seal..	C-28	Metal Energized C-Ring Performance .....	E-76
<b>EON</b> Metal O-Ring, Plain, Internal Pressure Face Seal.....	C-28	Metal Wire Ring Performance .....	E-77
<b>EOP</b> Metal O-Ring, Pressure Filled, Internal Pressure Face Seal .....	C-28	<b>Leak Rate Information</b> .....	E-78
<b>EOE</b> Metal O-Ring, O.D. Vented, External Pressure Face Seal .....	C-30	<b>Fatigue and Stress Relaxation</b> .....	E-79
<b>EOM</b> Metal O-Ring, Plain, External Pressure Face Seal.....	C-30	<b>Installation Guidelines</b>	
<b>EOR</b> Metal O-Ring, Pressure Filled, External Pressure Face Seal .....	C-30	Surface Roughness.....	E-80
<b>EUI</b> Metal U-Ring, Internal Pressure Face Seal .....	C-32	Surface Flatness .....	E-80
<b>EUE</b> Metal U-Ring, External Pressure Face Seal.....	C-34	Surface Hardness.....	E-81
<b>EWI</b> Metal Wire Ring, Internal Pressure Face Seal.....	C-36	Compression Limiters.....	E-81
<b>EWE</b> Metal Wire Ring, External Pressure Face Seal .....	C-38	Bolt Load and Tightening Torque Guidelines .....	E-82
<b>Axial Seals</b>		Seal Shaping Requirements for Non-Circular Seals.....	E-84
<b>ECA</b> Metal C-Ring, Axial Seal.....	C-40	<b>Metal Seal Manufacturing Specifications</b>	
<b>Seals for Standard Applications</b>		Metal Seal Roundness and Flatness .....	E-85
<b>Boss Seal</b> for MS-33649 Fluid Connection Boss and MS-33514/33656 Fitting Ends.....	C-42	Metal Seal Surface Finish .....	E-85
<b>Metal E-Ring</b> for AS1895 Flanges .....	C-44	Metal O-Ring Weld Finish .....	E-85
<b>Metal O-Ring</b> for Aerospace Standards.....	C-45	<b>Preferred C-Ring and Spring Energized C-Ring Sizes</b> .....	E-86
<b>Section D – Material Selection Process</b>		<b>Tolerance Reference Table</b> .....	E-92
<b>Selecting the Metal Seal Material</b>		<b>Conversion Tables</b> .....	E-93
Material Codes for Non-Spring Energized Seals .....	D-52	<b>Section F – Additional Metal Seal Styles</b>	
Material Codes for Spring Energized Seals.....	D-53	<b>Formed Seals</b> .....	F-96
Temperature Capabilities – Stainless Steel.....	D-53	<b>Precision Machined Seals</b> .....	F-96
Temperature Capabilities – Nickel Alloys .....	D-54	<b>Beaded Gaskets</b> .....	F-97
Temperature Capabilities – Cobalt Alloys.....	D-55	<b>Additional E-Ring Styles</b> .....	F-98
		<b>Frequently Asked Questions</b> .....	F-99
		<b>Application Data Sheets</b>	
		Face Seal .....	F-103
		Axial Seal .....	F-104

# The Global Leader in Sealing Technology



Parker Hannifin specializes in high performance engineered seals and sealing systems. The Advanced Products Business Unit was founded in 1954 and is headquartered in North Haven, Connecticut where a 60,000 square foot facility is home to a state-of-the-art metal seal plant, with fully integrated engineering analysis, design, production, assembly and test.

In addition to its diversified line of sealing components, Parker Hannifin offers fully engineered sealing systems for specialty applications over a wide range of challenging environments. Parker Hannifin's highly respected jet engine seals are widely used in commercial and aerospace engines and include E-rings, C-rings, O-rings and AS1895 seals. Parker also supplies cryogenic and high temperature metallic seals for the space shuttle main engine and other major rocket programs.

Parker Hannifin holds ISO 9001, AS9100, FAA approvals and various NADCAP approvals for special processes.



## Your True Partner for Sealing Solutions

We focus on serving the fluid containment needs of high-technology industries demanding absolute integrity and reliability. With our extensive and integrated line of seals and sealing systems we are able to design, test, analyze and produce the total fluid containment and sealing needs for extreme environments.

We have a reputation for innovative designs, high quality products, responsive support and a long history of producing customized solutions for unique extreme environments. You will find our company a vigorous partner in both development and production of your sealing system.



## Serving the Needs of High-Technology Industries

Dependable Sealing Systems for Safety-Critical and Extreme Environments

Making dependable sealing systems for safety-critical and extreme applications goes beyond excellence in design and manufacturing. It also means a deep commitment to quality...as a way of life.

Our company's diversification includes a wide variety of industries such as aerospace, semiconductor, oil and gas, power generation, military, transportation and automotive.

## Complete Sealing Systems

High Performance Engineered Seals and Sealing Systems

A sealing system consists of the main sealing elements such as our metal and polymer seals. These are mated with other system components such as flanges, clamps, connectors, valve bodies, to create a complete sealing system.

We are your partner for the entire sealing systems process from concept, design and development, through qualification and production. We provide expertise in complete project management, engineering, production, assembly and test in order to provide you a turnkey solution.



## Contract R&D

We offer our services in the research and development of materials and sealing technology. Our team of experienced engineers and scientists are able to develop and test new products and materials, perform extensive research and create new technology.



# The Global Leader in Sealing Technology

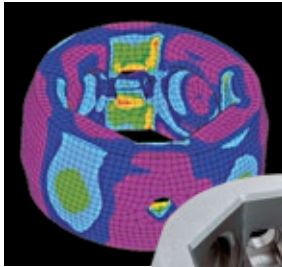

## State-of-the-Art Engineering

### Dependable Sealing Systems for Safety-Critical and Extreme Environments

Our technical strength comes from a broad based R&D and engineering staff with specialties across many scientific disciplines and engineering fields. Our engineering capabilities include:

- Fatigue and stress relaxation analysis
- Complete sealing system design, development and qualification testing in accordance with various industry design codes, including, American Petroleum Institute API 6A and API 17D, American Society of Mechanical Engineers ASME B31.3, ASME Section III, ASME Section VIII, Society of Automotive Engineers and Aerospace Standards
- Classical stress analysis
- Non-linear finite element analysis (FEA), 2-D and 3-D
- 3-D solid modeling and design of sealing systems components
- Modeling of loads, pressure effects and system dynamics for determining deflection and pressure induced stresses

## Materials Research

Comprehensive research, analysis and testing of metals, polymers, thermoplastics and composites enables us to develop and utilize materials that are best suited for your application. Factors such as strength, hardness, corrosion, temperature, fatigue, wear, friction, lubricity, elongation and extrusion are considered. Mindful of commercial issues, our material evaluation process also takes into consideration issues such as cost, availability and sourcing.

### Metallurgy

Our ongoing research program is focused on increasing the working temperature limits for seals. Exploring both metal and metal composite technologies that are less prone to stress relaxation at high temperatures, we are developing seals for tomorrow's gas turbine and rotary engines.

### Tribology

Studying the interaction of sliding surfaces, we employ multiple disciplines including the physics of friction, material science of wear and chemistry of lubrication. Testing diverse combinations of materials, heat treatments, surface treatments and coatings ensures our sealing systems will endure the dynamic requirements of the application and meet your requirements for performance and integrity.



## Manufacturing Technologies

Our core manufacturing technologies include metal roll and die forming, various fusion weld methods, CNC machining of metals, polymers and thermoplastics, vacuum heat treatment and electroplating. Production engineering skills include CAE development of roll and die forming tools, as well as the design and development of specialized forming machines and proprietary welding processes.

## Test Capabilities

An important part of the development process of a sealing system is the rigorous testing of the new design. We perform comprehensive qualification testing of the sealing systems as well as 100% functional testing of production units prior to delivery if desired.

Our extensive testing capabilities include:

- Pressure testing:  $10^{-5}$  torr to 20,000 psi (140 MPa)
- Helium mass spectroscopy leakage testing:  $10^{-11}$  mbar • liter/sec
- Temperature range: Cryogenic to 1800°F (982°C)
- High cycle fatigue testing
- Dynamic wear, friction and torque testing
- Extrusion testing
- Load versus deflection seal testing and measurement

We are also able to design elaborate test fixtures and equipment to meet the testing and functional requirements of your unique sealing system. When necessary, we collaborate with outside test facilities, universities, and our customer's own engineering departments and laboratories for specialized performance and qualification testing.



## Total Project Management - Budgeting, Scheduling & Planning

### The Key to Successful Projects

Every Parker sealing system is treated with a complete project management approach to ensure all aspects of the program run smoothly, efficiently and in strict adherence to your schedule requirements. The project manager is your single point contact; however, you also have access to our engineering staff throughout the program.

Our project manager develops a comprehensive program schedule identifying all project milestones and the "critical path." The project manager then coordinates the responsibilities of all functional teams including engineering, manufacturing, purchasing and quality control ensuring all tasks are performed on time. We believe the philosophy of a dedicated project manager is key to the success of the program.





## The Parker Metal Seal

The most extreme environments demand metal seal sealing solutions. Resilient metal seals meet the challenges of high temperatures or cryogenics, high pressures or hard vacuum, corrosive chemicals and even intense levels of radiation performing dependably year after year.

## Advantages of Metal Seals

- **Independent Optimization of Functional Components** means each discrete function including load, springback and outer sealing layer ductility/hardness can be optimized to ensure highest seal performance in every situation.
- **Directly Bonded Electroplating** onto the load bearing substrate eliminates unnecessary parts and failure modes.
- **Pressure Energization** uses internal hydrostatic pressures beneficially to supplement the self-energization forces from the tubing, jacket or spring. This becomes particularly helpful at high pressures over 3,000 psi (21 MPa) enabling metal seals to seal at 25,000 psi (170 MPa) and beyond, without risk of blow-by during proof or burst testing.
- **Total Metal Seal Service** covers custom and standard sized seals from 0.250" to 300" (6 mm to 7,60 m), including circular and non-circular shapes. We also offer the complete range of MS metal O-ring sizes, all AS1895 E-ring sizes, and the fastest delivery of C-rings from our preferred size list (see page E-86).
- **Rapid Response and JIT** (just-in-time) deliveries are assured due to design, testing and all manufacturing processes (including roll and die-forming, machining, welding, heat-treatment, electroplating) being performed within our own facilities.

**Metal Seals are the Preferred Solution** in many jet engine and space applications as well as oil, gas, and chemical equipment, plastic molding, diesel engines and a growing variety of industrial equipment. With ever more stringent pollution and leakage legislation, plus the demand for greater efficiency and lifetime reliability, metal seals provide the highest integrity sealing solutions for today's world and tomorrow's.



## Section A – General Metal Seal Information

### How To Use the Metal Seal Design Guide

The Advanced Products Business Unit's line of resilient metal seals are offered in a variety of sizes, shapes, cross sections and materials to satisfy the sealing needs of your extreme environments.

The metal seal part number defines all of the key design elements as indicated on the following page.

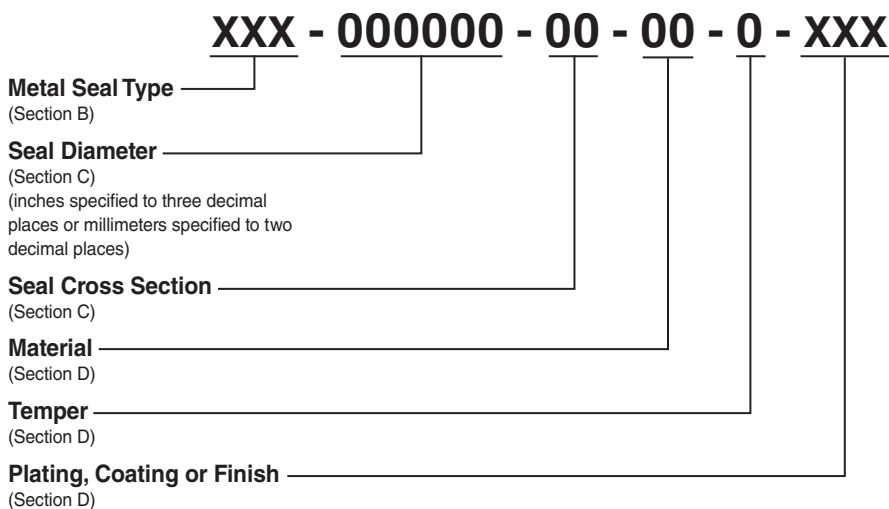

This design guide provides a rapid, unambiguous, self-selection process with all the features, applications and limitations of each product clearly stated. The guide is organized into sections which easily allows you to determine the part number of the metal seal that is right for your application.

**Section B** helps you to determine which metal seal type is most appropriate for your application.

**Section C** is organized by metal seal type. Having selected the best metal seal type from Section B, simply turn to the page in Section C for the seal selected and you will find all the groove and metal seal dimensions you need.

**Section D** lists the many available metal seal materials and assists you in determining which combination of materials is most appropriate for your sealing environment.

**Section E** provides supporting technical information and recommendations.

**Section F** shows a number of other metal seal designs which are available for unique applications when only a special seal will do. In these cases, please contact one of our applications engineers at any of our worldwide offices and we will be happy to assist you. Please send us your application data sheet (Page F-103 & F-104) for a fast, complete response.

#### WARNING

These products can expose you to chemicals including carbon black (airborne and extracts), antimony trioxide, titanium dioxide, silica (crystalline), di(2-ethylhexyl)phthalate, ethylene thiourea, acrylonitrile, 1,3-butadiene, epichlorohydrin, toluene diisocyanate, tetrafluoroethylene, ethylbenzene, formaldehyde, furfuryl alcohol, glass fibers, methyl isobutyl ketone, nickel (metallic and compounds), lead and lead compounds which are known to the state of California to cause cancer; and 1,3-butadiene, epichlorohydrin, di(2-ethylhexyl)phthalate, di-isodecyl phthalate, ethylene thiourea, methyl isobutyl ketone, methanol, toluene, lead and lead compounds which are known to the state of California to cause birth defects and other reproductive harm. For more information go to [www.P65Warnings.ca.gov](http://www.P65Warnings.ca.gov).



## Market Applications

Aerospace						
Application	C-Seal	E-Seal	O-Ring	Mil Std	Boss Seal	Engineered
Accessories	✓					
Gas Turbine Bleed Air		✓		✓		
Gas Turbine Compressor Sections		✓				
Gas Turbine Cooling Air		✓				✓
Gas Turbine Fuel Nozzles						✓
Gas Turbine Fuel Systems	✓		✓			✓
Gas Turbine, Turbine Sections		✓				
Hydraulic Systems	✓					
MS 33649 Fluid Connection Boss					✓	
MS Standards				✓		
Probe and Sensors	✓					
Rocket Fuel Systems	✓					✓
V-Band Coupling		✓				

Oil & Gas, Power Generation						
Application	C-Seal	E-Seal	O-Ring	Mil Std	Boss Seal	Engineered
Gas Turbine Casing	✓					✓
Gas Turbine Combustor						✓
Gas Turbine Compressor Sections		✓				
Gas Turbine Cooling Air		✓				✓
Gas Turbine Fuel Nozzles	✓					✓
Gas Turbine Fuel Systems	✓					
Gas Turbine, Turbine Sections		✓				✓
Gas Turbine Vane Seal		✓				✓
Heat Exchangers	✓		✓			
MS 33649 Fluid Connection Boss					✓	
Nuclear Waste Container Casks	✓	✓				✓
Oil Field Control Systems						✓
Piping and Flanges	✓					
Steam Turbine Casing Seals	✓					✓
Valve Seats	✓					
Valves	✓	✓				✓

Military						
Application	C-Seal	E-Seal	O-Ring	Mil Std	Boss Seal	Engineered
Aerospace Standards				✓		
Imaging Devices	✓					✓
Missiles	✓	✓	✓	✓		✓
MS 33649 Fluid Connection Boss					✓	
Satellite Systems	✓					✓
Vehicle Engine Exhaust Systems	✓					✓
Weapons	✓					✓

Semiconductor						
Application	C-Seal	E-Seal	O-Ring	Mil Std	Boss Seal	Engineered
Gas Delivery Systems						✓

Heavy Duty Mobile, Transportation Automotive						
Application	C-Seal	E-Seal	O-Ring	Mil Std	Boss Seal	Engineered
Turbochargers	✓					✓
Engine Exhaust Systems	✓					✓

**⚠ WARNING**  
 These products can expose you to chemicals including carbon black (airborne and extracts), antimony trioxide, titanium dioxide, silica (crystalline), di(2-ethylhexyl)phthalate, ethylene thiourea, acrylonitrile, 1,3-butadiene, epichlorohydrin, toluene diisocyanate, tetrafluoroethylene, ethylbenzene, formaldehyde, furfuryl alcohol, glass fibers, methyl isobutyl ketone, nickel (metallic and compounds), lead and lead compounds which are known to the state of California to cause cancer; and 1,3-butadiene, epichlorohydrin, di(2-ethylhexyl)phthalate, di-isodecyl phthalate, ethylene thiourea, methyl isobutyl ketone, methanol, toluene, lead and lead compounds which are known to the state of California to cause birth defects and other reproductive harm. For more information go to [www.P65Warnings.ca.gov](http://www.P65Warnings.ca.gov).

# Section B - Metal Seal Type Selection

## Selecting the Metal Seal Type for Your Application

Metal seals are produced in a number of standard designs which are appropriate for use in a broad spectrum of the most commonly encountered applications. The **Metal Seal Type** is designated in the part number as shown below.

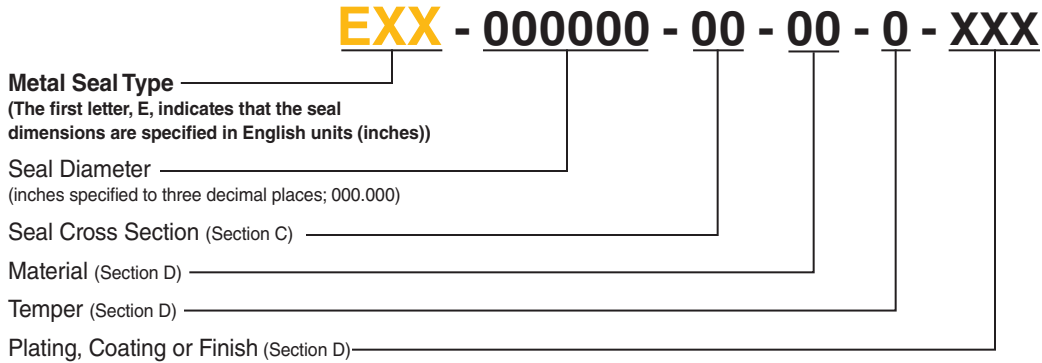

The flow diagrams on the following pages are designed to provide guidance to the appropriate metal seal type for your application. There are two basic types of applications:

### Face Seal Applications

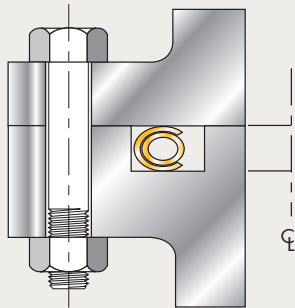

**High Load**  
Generally, the high load seals provide greater leak tightness and are preferred when there is sufficient seating load (the load required to compress the seal) and little flange movement due to thermal excursions, vibrations, etc.

See page B-12.

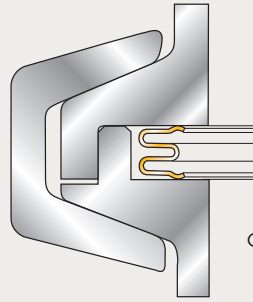

**High Elasticity**  
Lower load seals are frequently used when resiliency or springback is needed to maintain effective sealing during flange separation or rotation. Additionally, low load seals are suitable for applications where seating load is limited or there is concern about yielding or damaging the mating hardware surfaces.

See page B-13.

### Axial Seal Applications

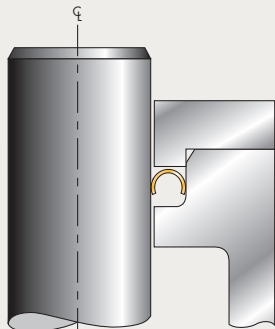

**ECA, Axial C-Ring** can be used as either a static seal or in semi-dynamic applications such as a quarter-turn valve stem seal.

See page C-41.

#### WARNING

These products can expose you to chemicals including carbon black (airborne and extracts), antimony trioxide, titanium dioxide, silica (crystalline), di(2-ethylhexyl)phthalate, ethylene thiourea, acrylonitrile, 1,3-butadiene, epichlorohydrin, toluene diisocyanate, tetrafluoroethylene, ethylbenzene, formaldehyde, furfuryl alcohol, glass fibers, methyl isobutyl ketone, nickel (metallic and compounds), lead and lead compounds which are known to the state of California to cause cancer; and 1,3-butadiene, epichlorohydrin, di(2-ethylhexyl)phthalate, di-isodecyl phthalate, ethylene thiourea, methyl isobutyl ketone, methanol, toluene, lead and lead compounds which are known to the state of California to cause birth defects and other reproductive harm. For more information go to [www.P65Warnings.ca.gov](http://www.P65Warnings.ca.gov).



# Face Seals for Higher Seating Loads & Lowest Leakage Rates

(Greater than 100 lb/inch circumference)

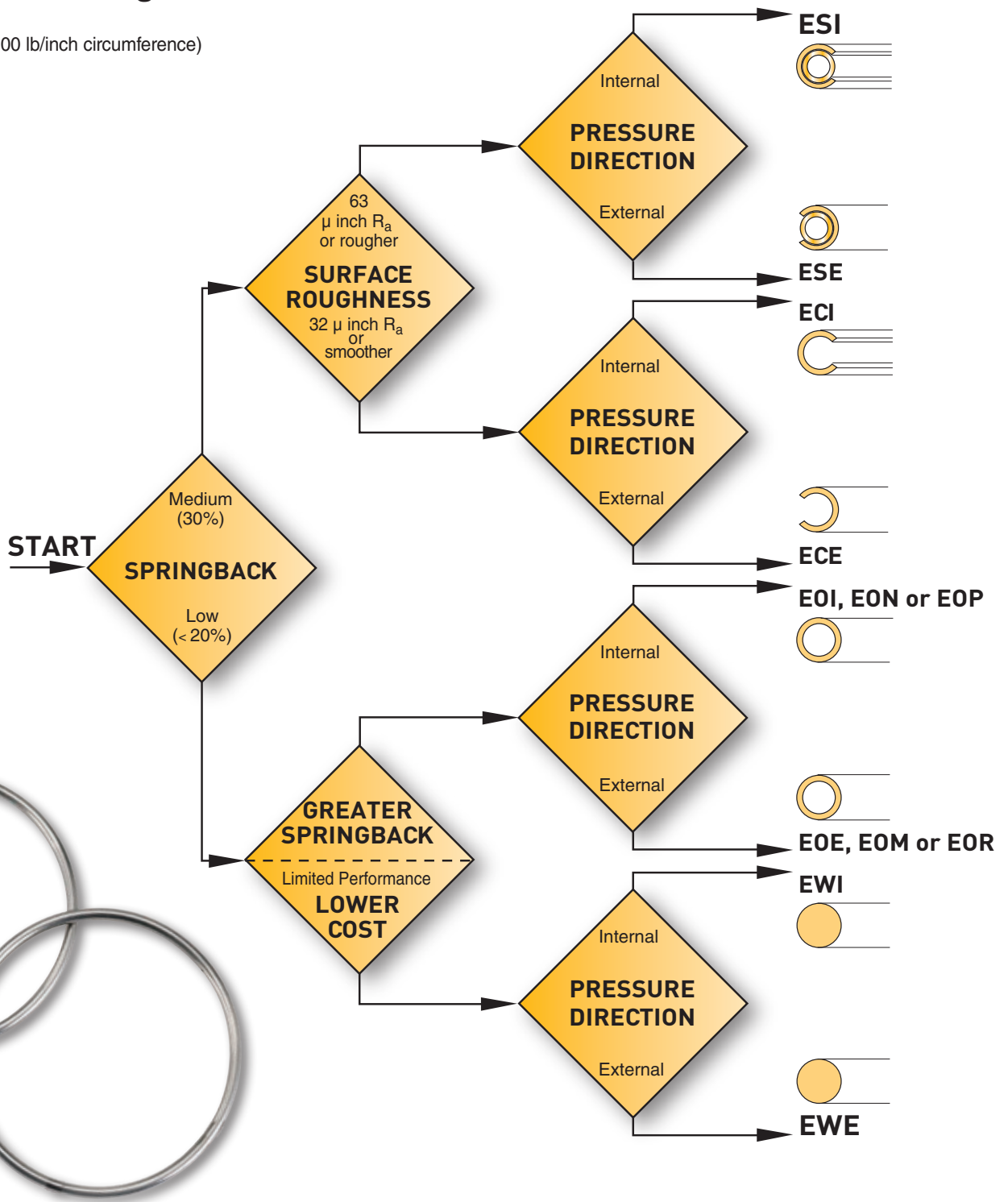

**WARNING**

These products can expose you to chemicals including carbon black (airborne and extracts), antimony trioxide, titanium dioxide, silica (crystalline), di(2-ethylhexyl)phthalate, ethylene thiourea, acrylonitrile, 1,3-butadiene, epichlorohydrin, toluene diisocyanate, tetrafluoroethylene, ethylbenzene, formaldehyde, furfuryl alcohol, glass fibers, methyl isobutyl ketone, nickel (metallic and compounds), lead and lead compounds which are known to the state of California to cause cancer; and 1,3-butadiene, epichlorohydrin, di(2-ethylhexyl)phthalate, di-isodecyl phthalate, ethylene thiourea, methyl isobutyl ketone, methanol, toluene, lead and lead compounds which are known to the state of California to cause birth defects and other reproductive harm. For more information go to [www.P65Warnings.ca.gov](http://www.P65Warnings.ca.gov).

# Face Seals for Lower Seating Loads & Higher Springback

(Less than 100 lb/inch circumference)

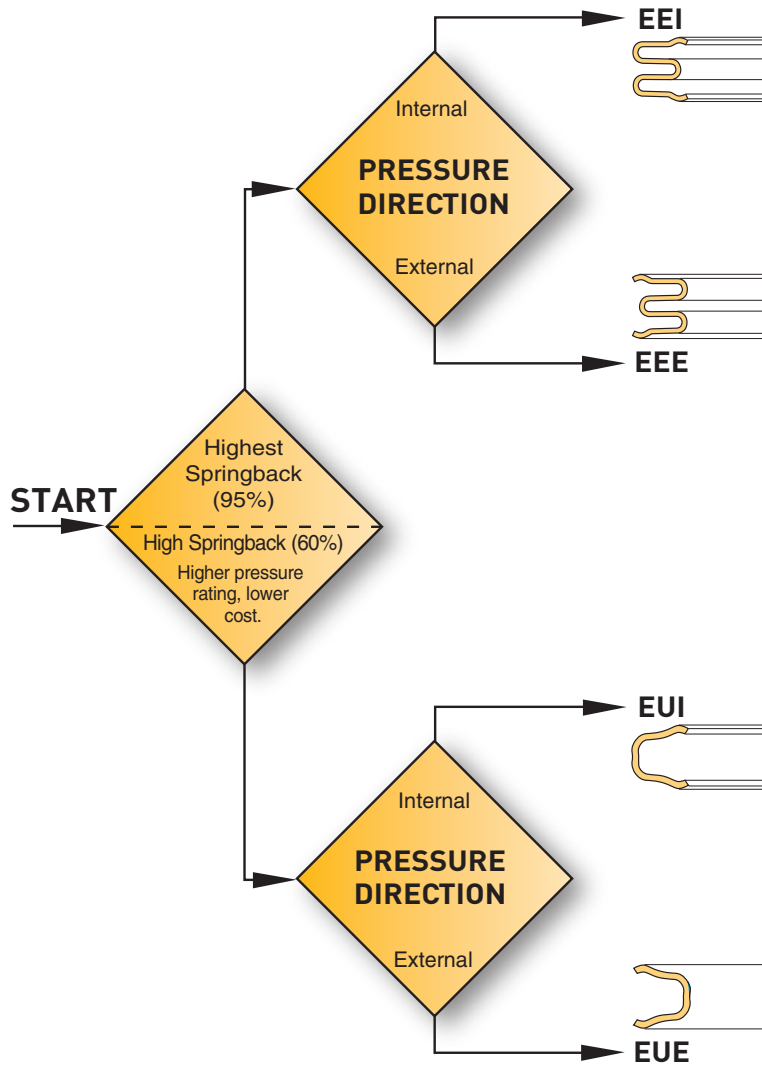

Section B  
Metal Seal Type Selection

**WARNING**

These products can expose you to chemicals including carbon black (airborne and extracts), antimony trioxide, titanium dioxide, silica (crystalline), di(2-ethylhexyl)phthalate, ethylene thiourea, acrylonitrile, 1,3-butadiene, epichlorohydrin, toluene diisocyanate, tetrafluoroethylene, ethylbenzene, formaldehyde, furfuryl alcohol, glass fibers, methyl isobutyl ketone, nickel (metallic and compounds), lead and lead compounds which are known to the state of California to cause cancer; and 1,3-butadiene, epichlorohydrin, di(2-ethylhexyl)phthalate, di-isodecyl phthalate, ethylene thiourea, methyl isobutyl ketone, methanol, toluene, lead and lead compounds which are known to the state of California to cause birth defects and other reproductive harm. For more information go to [www.P65Warnings.ca.gov](http://www.P65Warnings.ca.gov).



## Seal Selection at a Glance

In addition to the metal seal selection flow diagrams on the preceding pages, the following rating table provides simple guidelines which can be used to confirm the appropriate metal seal selection. Refer to the table below for a comparison of metal seal types.

- Ratings:**
- Excellent
  - Very Good
  - Good
  - Fair
  - ⊘ Not Recommended

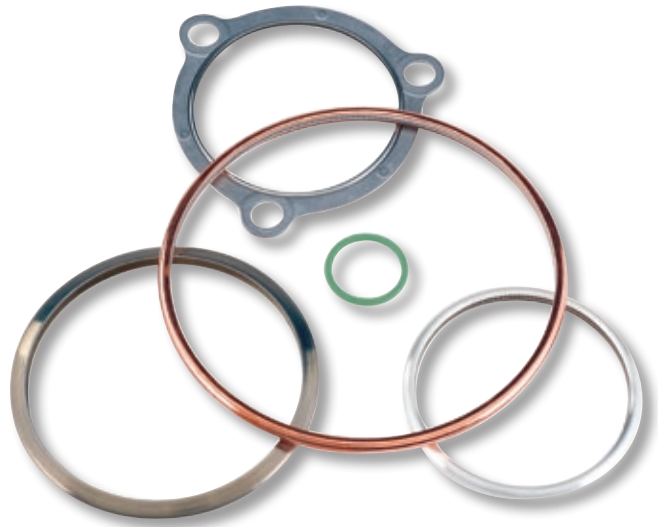

Seal Type	Sealing Requirements					
	High Springback	Low Load	High Load	Low Leak Rate	Pressure Capability	Low Cost
Metal C-Ring	○	○	○	●	●	●
Metal E-Ring	●	●	⊘	○	○	○
Metal O-Ring	○	⊘	●	●	●	●
Metal U-Ring	●	●	⊘	○	●	○
Metal Wire Ring	⊘	⊘	●	○	●	●
Spring Energized C-Ring	○	⊘	●	●	●	○

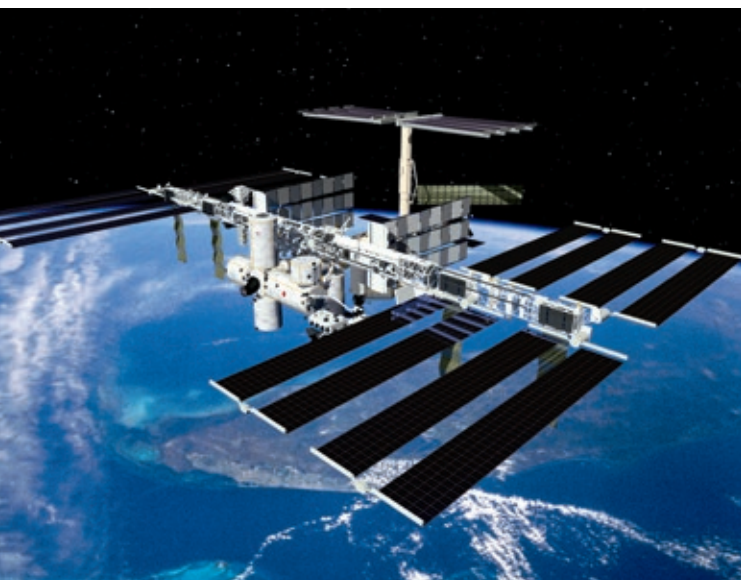

## Standard Metal Seals for Specific and Standard Applications

The metal seal type for these applications are listed below.

Seal Description	Metal Seal Type
Boss Seal for MS-33649 Fluid Connection Boss and MS-33514/33656 Fitting Ends .....	ECl
Metal E-Ring for AS1895 Flanges .....	EEI
Metal O-Ring for Aerospace Standards.....	EON

**⚠ WARNING**

These products can expose you to chemicals including carbon black (airborne and extracts), antimony trioxide, titanium dioxide, silica (crystalline), di(2-ethylhexyl)phthalate, ethylene thiourea, acrylonitrile, 1,3-butadiene, epichlorohydrin, toluene diisocyanate, tetrafluoroethylene, ethylbenzene, formaldehyde, furfuryl alcohol, glass fibers, methyl isobutyl ketone, nickel (metallic and compounds), lead and lead compounds which are known to the state of California to cause cancer; and 1,3-butadiene, epichlorohydrin, di(2-ethylhexyl)phthalate, di-isodecyl phthalate, ethylene thiourea, methyl isobutyl ketone, methanol, toluene, lead and lead compounds which are known to the state of California to cause birth defects and other reproductive harm. For more information go to [www.P65Warnings.ca.gov](http://www.P65Warnings.ca.gov).

# Section C – Metal Seal Size Selection

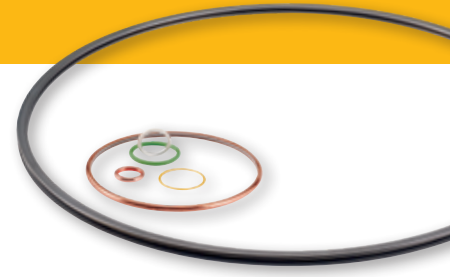

## Selecting the Metal Seal Size for Your Application

Metal seals are available in any diameter from 0.250 inch to 300 inches and a variety of free heights to fit the various cavity sizes you may have.

The metal seal size is designated in the part number as shown below.

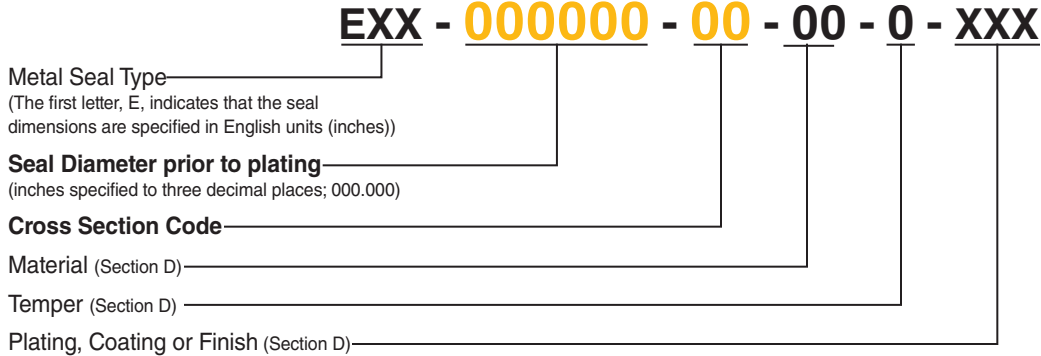

Refer to the page of the metal seal type selected for your application to determine the appropriate seal diameter, cross section and cavity dimensions. Cavity, seal dimensions and seal performance data for the standard metal seals can be found on the following pages:

Seal Type	Seal Description	Page
<b>Face Seals</b>		
ECI	Metal C-Ring, Internal Pressure Face Seal.....	C-16
ECE	Metal C-Ring, External Pressure Face Seal.....	C-18
ESI	Spring Energized Metal C-Ring, Internal Pressure Face Seal.....	C-20
ESE	Spring Energized Metal C-Ring, External Pressure Face Seal.....	C-22
EEI	Metal E-Ring, Internal Pressure Face Seal.....	C-24
EEE	Metal E-Ring, External Pressure Face Seal.....	C-26
EOI	Metal O-Ring, I.D. Vented, Internal Pressure Face Seal.....	C-28
EON	Metal O-Ring, Plain, Internal Pressure Face Seal.....	C-28
EOP	Metal O-Ring, Pressure Filled, Internal Pressure Face Seal.....	C-28
EOE	Metal O-Ring, O.D. Vented, External Pressure Face Seal.....	C-30
EOM	Metal O-Ring, Plain, External Pressure Face Seal.....	C-30
EOR	Metal O-Ring, Pressure Filled, External Pressure Face Seal.....	C-30
EUI	Metal U-Ring, Internal Pressure Face Seal.....	C-32
EUE	Metal U-Ring, External Pressure Face Seal.....	C-34
EWI	Metal Wire Ring, Internal Pressure Face Seal.....	C-36
EWE	Metal Wire Ring, External Pressure Face Seal.....	C-38
<b>Axial Seals</b>		
ECA	Metal C-Ring, Axial Seal.....	C-40
<b>Seals for Standard Applications</b>		
<b>Boss Seal</b>	for MS-33649 Fluid Connection Boss and MS-33514/33656 Fitting Ends.....	C-42
<b>Metal E-Ring</b>	for AS1895 Flanges.....	C-44
<b>Metal O-Ring</b>	for Aerospace Standards.....	C-45

**WARNING**

These products can expose you to chemicals including carbon black (airborne and extracts), antimony trioxide, titanium dioxide, silica (crystalline), di(2-ethylhexyl)phthalate, ethylene thiourea, acrylonitrile, 1,3-butadiene, epichlorohydrin, toluene diisocyanate, tetrafluoroethylene, ethylbenzene, formaldehyde, furfuryl alcohol, glass fibers, methyl isobutyl ketone, nickel (metallic and compounds), lead and lead compounds which are known to the state of California to cause cancer; and 1,3-butadiene, epichlorohydrin, di(2-ethylhexyl)phthalate, di-isodecyl phthalate, ethylene thiourea, methyl isobutyl ketone, methanol, toluene, lead and lead compounds which are known to the state of California to cause birth defects and other reproductive harm. For more information go to [www.P65Warnings.ca.gov](http://www.P65Warnings.ca.gov).



## ECI Metal C-Ring Internal Pressure Face Seal

### Applications:

- Excellent internally pressurized static face seal for valve assemblies, pressure vessels, jet engines, fuel injectors, separable fittings, etc.
- Moderate load permits the use of lighter flanges and fewer bolts.
- Good springback properties to accommodate thermal cycles and joint separation.
- Temperature range from cryogenics to 1600°F.
- Pressure range from vacuum to 76,000 psi and above.

### Features:

- Wide range of 10 standard free heights from 1/32" to 1/2".
- Available in any diameter from 0.250" to 120", plus hundreds of preferred sizes (refer to page E-86).
- Relatively flexible for use with non-flat flanges.
- Multiple material choices for high temperature strength, good spring back, corrosion and fatigue resistance.
- Optimized one piece construction for low cost.
- Wide range of plating options (refer to page D-59) for superior sealing.
- Uses jacket strength and hydrostatic forces additively to increase sealing forces at higher pressures.
- Circular, race-track and other custom shapes available. Tri-lobed or elliptical C-rings available for snap-in/snap-out convenience.

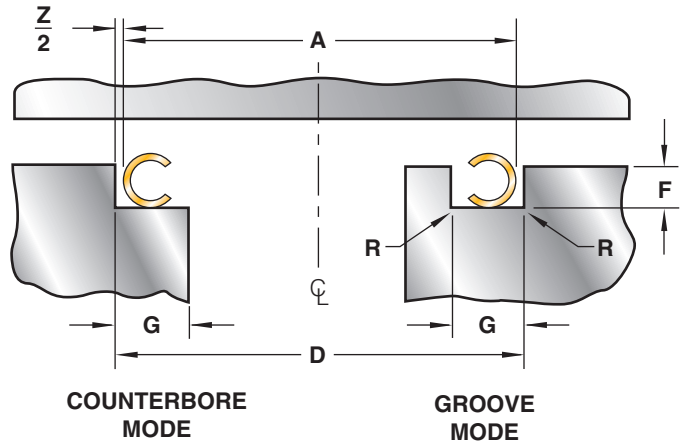

Cavity Dimensions				
Nominal Cross Section	D	F	G	R
	O.D. Range Tolerance H10	Depth Range	Minimum Width	Maximum Radius
1/32	0.250 – 1.000	0.025 – 0.027	0.040	0.010
3/64	0.325 – 2.000	0.037 – 0.040	0.055	0.012
1/16	0.375 – 8.000	0.050 – 0.054	0.075	0.015
3/32	0.500 – 16.000	0.075 – 0.079	0.105	0.020
1/8	1.000 – 24.000	0.100 – 0.105	0.135	0.030
5/32	1.250 – 30.000	0.125 – 0.130	0.170	0.050
3/16	3.000 – 36.000	0.151 – 0.157	0.200	0.050
1/4	4.000 – 48.000	0.200 – 0.208	0.260	0.060
3/8	12.000 – 80.000	0.300 – 0.316	0.380	0.060
1/2	24.000 – 120.000	0.400 – 0.420	0.500	0.060

All dimensions are in inches.  
The tolerance reference table can be found on page E-92.



### ⚠ WARNING

These products can expose you to chemicals including carbon black (airborne and extracts), antimony trioxide, titanium dioxide, silica (crystalline), di(2-ethylhexyl)phthalate, ethylene thiourea, acrylonitrile, 1,3-butadiene, epichlorohydrin, toluene diisocyanate, tetrafluoroethylene, ethylbenzene, formaldehyde, furfuryl alcohol, glass fibers, methyl isobutyl ketone, nickel (metallic and compounds), lead and lead compounds which are known to the state of California to cause cancer; and 1,3-butadiene, epichlorohydrin, di(2-ethylhexyl)phthalate, di-isodecyl phthalate, ethylene thiourea, methyl isobutyl ketone, methanol, toluene, lead and lead compounds which are known to the state of California to cause birth defects and other reproductive harm. For more information go to [www.P65Warnings.ca.gov](http://www.P65Warnings.ca.gov).



**Part Numbering:**

Refer to Section A, page A-9 for part numbering convention. The seal size is specified in the part number as follows:

ECI - 000000 - 00 - 00 - 0 - XXX

Seal O.D. prior to plating (dimension A) to three decimal places. (Example: A 3.000 inch seal is specified as 003000)

Metal Seal Cross Section Code

Material (Section D)

Temper (Section D)

Plating, Coating or Finish (Section D)

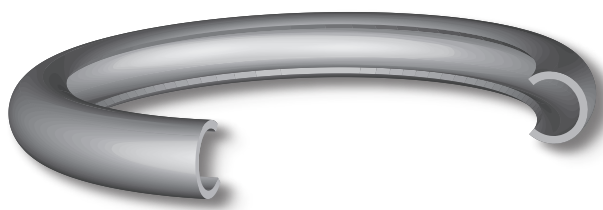
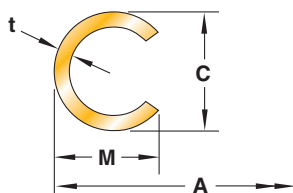

**Seal and Cavity Sizing:**

Seal free height is based on cavity diameter and depth alone. Seal diameter (dimension A) is derived below.

$$A = D - Z - 2P_{max}$$

(tolerance h11, see page E-92)

Where: D = Minimum cavity O.D.

Z = Diametral clearance between cavity and seal

P<sub>max</sub> = Maximum plating thickness (from page D-60)

Seal Dimensions					
Nominal Cross Section	Z	M	C	t	Cross Section Code
	Diametral Clearance	Maximum Radial Width	Free Height	Material Thickness	
1/32	0.003	0.028	0.031 ±0.002	0.006	01
				0.007	02
3/64	0.005	0.038	0.047 ±0.002	0.006	03
				0.008	04
1/16	0.006	0.050	0.062 ±0.002	0.006	05
				0.010	06
3/32	0.008	0.075	0.094 ±0.002	0.010	07
				0.015	08
1/8	0.012	0.100	0.125 ±0.003	0.015	09
				0.020	10
5/32	0.016	0.125	0.156 ±0.003	0.016	11
				0.024	12
3/16	0.018	0.150	0.188 ±0.004	0.020	13
				0.030	14
1/4	0.020	0.200	0.250 ±0.004	0.025	15
				0.038	16
3/8	0.030	0.300	0.375 ±0.004	0.038	17
				0.050	18
1/2	0.040	0.400	0.500 ±0.005	0.050	19
				0.065	20

Performance		
Seating Load (pounds per inch circumference)	Springback (inches)	Working* Pressure Rating (psi)
160	0.0015	76000
230	0.001	99000
110	0.002	41000
230	0.002	62000
80	0.003	29000
280	0.002	57000
160	0.006	23500
400	0.005	56500
300	0.007	38000
600	0.006	56500
260	0.009	31000
600	0.007	53500
350	0.010	32500
750	0.008	56500
400	0.013	30000
1000	0.009	52500
600	0.020	30500
1500	0.015	43500
800	0.025	30000
1700	0.020	42000

All dimensions are in inches and prior to plating. Performance data is based on Alloy 718 material with -6 treatment. Seal performance is discussed in Section E. \*If working pressures exceed these ratings consult Parker for recommendations.

**WARNING**

These products can expose you to chemicals including carbon black (airborne and extracts), antimony trioxide, titanium dioxide, silica (crystalline), di(2-ethylhexyl)phthalate, ethylene thiourea, acrylonitrile, 1,3-butadiene, epichlorohydrin, toluene diisocyanate, tetrafluoroethylene, ethylbenzene, formaldehyde, furfuryl alcohol, glass fibers, methyl isobutyl ketone, nickel (metallic and compounds), lead and lead compounds which are known to the state of California to cause cancer; and 1,3-butadiene, epichlorohydrin, di(2-ethylhexyl)phthalate, di-isodecyl phthalate, ethylene thiourea, methyl isobutyl ketone, methanol, toluene, lead and lead compounds which are known to the state of California to cause birth defects and other reproductive harm. For more information go to [www.P65Warnings.ca.gov](http://www.P65Warnings.ca.gov).



# ECE Metal C-Ring External Pressure Face Seal

### Applications:

- Excellent externally pressurized static face seal.
- Moderate load permits the use of lighter flanges and fewer bolts.
- Good springback properties to accommodate thermal cycles and joint separation.
- Temperature range from cryogenics to 1600°F.
- Pressure range from vacuum to 76,000 psi and above.

### Features:

- Wide range of 10 standard free heights from 1/32" to 1/2".
- Available in any diameter from 0.250" to 120", plus hundreds of preferred sizes (refer to page E-89).
- Relatively flexible for use with non-flat flanges.
- Multiple material choices for high temperature strength, good springback, corrosion and fatigue resistance.
- Optimized one piece construction for low cost.
- Wide range of plating options (refer to page D-59) for superior sealing.
- Uses jacket strength and hydrostatic forces additively to increase sealing forces at higher pressures.
- Circular, race-track and other custom shapes available. Tri-lobed or elliptical C-rings available for snap-in/snap-out convenience.

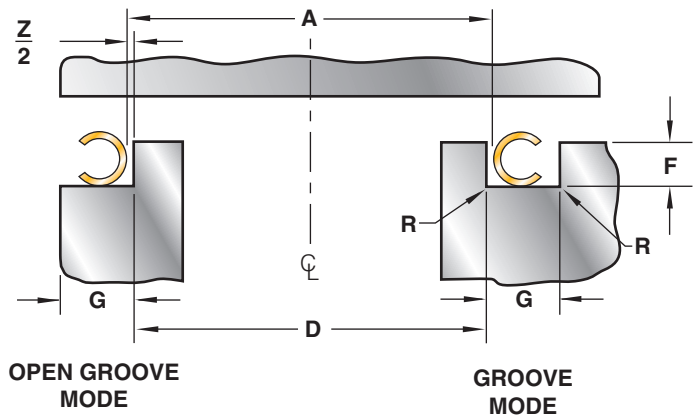

Cavity Dimensions				
Nominal Cross Section	D	F	G	R
	I.D. Range Tolerance h10	Depth Range	Minimum Width	Maximum Radius
1/32	0.200 – 1.000	0.025 – 0.027	0.040	0.010
3/64	0.300 – 2.000	0.037 – 0.040	0.055	0.012
1/16	0.350 – 8.000	0.050 – 0.054	0.075	0.015
3/32	0.400 – 16.000	0.075 – 0.079	0.105	0.020
1/8	0.800 – 24.000	0.100 – 0.105	0.135	0.030
5/32	1.250 – 30.000	0.125 – 0.130	0.170	0.050
3/16	3.000 – 36.000	0.151 – 0.157	0.200	0.050
1/4	4.000 – 48.000	0.200 – 0.208	0.260	0.060
3/8	12.000 – 80.000	0.300 – 0.316	0.380	0.060
1/2	24.000 – 120.000	0.400 – 0.420	0.500	0.060

All dimensions are in inches.  
The tolerance reference table can be found on page E-92.

### ⚠ WARNING

These products can expose you to chemicals including carbon black (airborne and extracts), antimony trioxide, titanium dioxide, silica (crystalline), di(2-ethylhexyl)phthalate, ethylene thiourea, acrylonitrile, 1,3-butadiene, epichlorohydrin, toluene diisocyanate, tetrafluoroethylene, ethylbenzene, formaldehyde, furfuryl alcohol, glass fibers, methyl isobutyl ketone, nickel (metallic and compounds), lead and lead compounds which are known to the state of California to cause cancer; and 1,3-butadiene, epichlorohydrin, di(2-ethylhexyl)phthalate, di-isodecyl phthalate, ethylene thiourea, methyl isobutyl ketone, methanol, toluene, lead and lead compounds which are known to the state of California to cause birth defects and other reproductive harm. For more information go to [www.P65Warnings.ca.gov](http://www.P65Warnings.ca.gov).

**Part Numbering:**

Refer to Section A, page A-9 for part numbering convention. The seal size is specified in the part number as follows:

**ECE - 000000 - 00 - 00 - 0 - XXX**

Seal I.D. prior to plating (dimension A) to three decimal places. (Example: A 3.000 inch seal is specified as 003000)

Metal Seal Cross Section Code

Material (Section D)

Temper (Section D)

Plating, Coating or Finish (Section D)

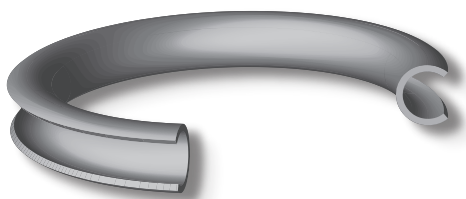

**Seal and Cavity Sizing:**

Seal free height is based on cavity diameter and depth alone. Seal diameter (dimension A) is derived below.

$$A = D + Z + 2P_{max}$$

(tolerance H11, see page E-92)

Where: D = Minimum cavity I.D.

Z = Diametral clearance between cavity and seal

P<sub>max</sub> = Maximum plating thickness (from page D-60)

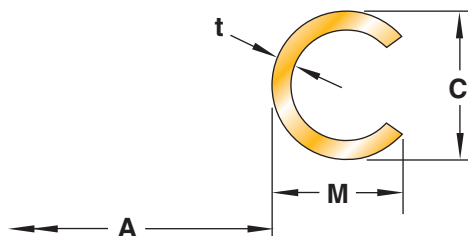

Seal Dimensions					
Nominal Cross Section	Z	M	C	t	Cross Section Code
	Diametral Clearance	Maximum Radial Width	Free Height	Material Thickness	
1/32	0.003	0.028	0.031 ±0.002	0.006	01
				0.007	02
3/64	0.005	0.038	0.047 ±0.002	0.006	03
				0.008	04
1/16	0.006	0.050	0.062 ±0.002	0.006	05
				0.010	06
3/32	0.008	0.075	0.094 ±0.002	0.010	07
				0.015	08
1/8	0.012	0.100	0.125 ±0.003	0.015	09
				0.020	10
5/32	0.016	0.125	0.156 ±0.003	0.016	11
				0.024	12
3/16	0.018	0.150	0.188 ±0.004	0.020	13
				0.030	14
1/4	0.020	0.200	0.250 ±0.004	0.025	15
				0.038	16
3/8	0.030	0.300	0.375 ±0.004	0.038	17
				0.050	18
1/2	0.040	0.400	0.500 ±0.005	0.050	19
				0.065	20

Performance		
Seating Load (pounds per inch circumference)	Springback (inches)	Working* Pressure Rating (psi)
160	0.0015	76000
230	0.001	99000
110	0.002	41000
230	0.002	62000
80	0.003	29000
280	0.002	57000
160	0.006	23500
400	0.005	56500
300	0.007	38000
600	0.006	56500
260	0.009	31000
600	0.007	53500
350	0.010	32500
750	0.008	56500
400	0.013	30000
1000	0.009	52500
600	0.020	30500
1500	0.015	43500
800	0.025	30000
1700	0.020	42000

All dimensions are in inches and prior to plating. Performance data is based on Alloy 718 material with -6 treatment. Seal performance is discussed in Section E. \*If working pressures exceed these ratings consult Parker for recommendations.

**WARNING**

These products can expose you to chemicals including carbon black (airborne and extracts), antimony trioxide, titanium dioxide, silica (crystalline), di(2-ethylhexyl)phthalate, ethylene thiourea, acrylonitrile, 1,3-butadiene, epichlorohydrin, toluene diisocyanate, tetrafluoroethylene, ethylbenzene, formaldehyde, furfuryl alcohol, glass fibers, methyl isobutyl ketone, nickel (metallic and compounds), lead and lead compounds which are known to the state of California to cause cancer; and 1,3-butadiene, epichlorohydrin, di(2-ethylhexyl)phthalate, di-isodecyl phthalate, ethylene thiourea, methyl isobutyl ketone, methanol, toluene, lead and lead compounds which are known to the state of California to cause birth defects and other reproductive harm. For more information go to [www.P65Warnings.ca.gov](http://www.P65Warnings.ca.gov).



# ESI Spring Energized Metal C-Ring Internal Pressure Face Seal

### Applications:

- Similar to ECI, but higher loads for use with rougher mating surfaces.
- Excellent for pressure vessel closures; manways, hand-holes; steam generators, gasoline/diesel engine fire rings, exhaust joints, flanges with a rougher surface finish.
- Best choice for non-flat mating surfaces.
- For internally pressurized joints.
- For externally pressurized joints to avoid passage of working fluid into the seal cavity (reduced working pressure rating).

### Features:

- Lowest leak rate.
- Internal Spring provides high pressure capabilities of up to 38,000 psi and above.
- All plating options available.
- Excellent footprint with good plastic flow of plating material.
- Available in any diameter from 0.750" to 120", plus hundreds of preferred sizes (see page E-88).
- Wide range of eight standard free heights from 1/16" to 1/2".
- Multiple material choices for high temperature strength, good spring-back, corrosion and fatigue resistance.
- Uses jacket forces, spring forces and hydrostatic forces additively to increase sealing forces at higher pressures.
- Circular, race-track and other custom shapes available. Tri-lobed or elliptical Spring Energized C-rings available for snap-in/snap-out convenience.

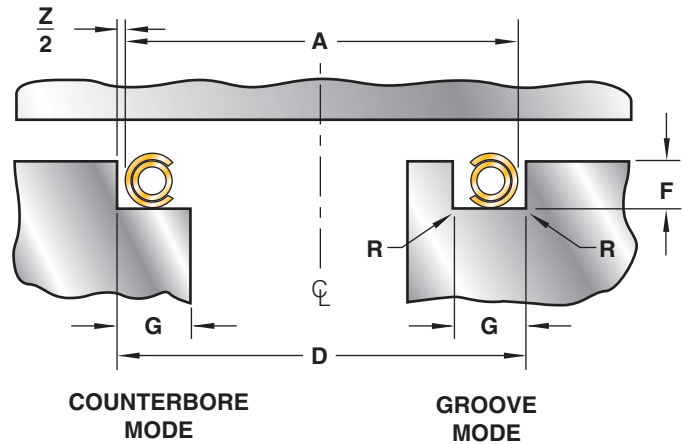

Cavity Dimensions				
Nominal Cross Section	D	F	G	R
	O.D. Range Tolerance H10	Depth Range	Minimum Width	Maximum Radius
1/16	0.750 – 8.000	0.050 – 0.054	0.090	0.015
3/32	1.000 – 16.000	0.075 – 0.079	0.125	0.020
1/8	1.000 – 24.000	0.100 – 0.105	0.160	0.030
5/32	1.250 – 30.000	0.125 – 0.130	0.200	0.050
3/16	3.000 – 36.000	0.151 – 0.157	0.250	0.050
1/4	4.000 – 72.000	0.200 – 0.208	0.350	0.060
3/8	12.000 – 120.000	0.300 – 0.316	0.500	0.060
1/2	24.0000 – 300.000	0.400 – 0.420	0.650	0.060

All dimensions are in inches.  
The tolerance reference table can be found on page E-92.

### ⚠ WARNING

These products can expose you to chemicals including carbon black (airborne and extracts), antimony trioxide, titanium dioxide, silica (crystalline), di(2-ethylhexyl)phthalate, ethylene thiourea, acrylonitrile, 1,3-butadiene, epichlorohydrin, toluene diisocyanate, tetrafluoroethylene, ethylbenzene, formaldehyde, furfuryl alcohol, glass fibers, methyl isobutyl ketone, nickel (metallic and compounds), lead and lead compounds which are known to the state of California to cause cancer; and 1,3-butadiene, epichlorohydrin, di(2-ethylhexyl)phthalate, di-isodecyl phthalate, ethylene thiourea, methyl isobutyl ketone, methanol, toluene, lead and lead compounds which are known to the state of California to cause birth defects and other reproductive harm. For more information go to [www.P65Warnings.ca.gov](http://www.P65Warnings.ca.gov).

**Part Numbering:**

Refer to Section A, page A-9 for part numbering convention. The seal size is specified in the part number as follows:

**ESI - 000000 - 00 - 00 - 0 - XXX**

Seal O.D. prior to plating (dimension A) to three decimal places. (Example: A 3.000 inch seal is specified as 003000)

Metal Seal Cross Section Code

Material (Section D)

Temper (Section D)

Plating, Coating or Finish (Section D)

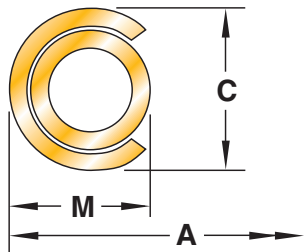

**Seal and Cavity Sizing:**

Seal free height is based on cavity diameter and depth alone. Seal diameter (dimension A) is derived below.

$$A = D - Z - 2P_{max}$$

(tolerance h11, see page E-92)

Where: D = Minimum cavity O.D.

Z = Diametral clearance between cavity and seal

P<sub>max</sub> = Maximum plating thickness (from page D-60)

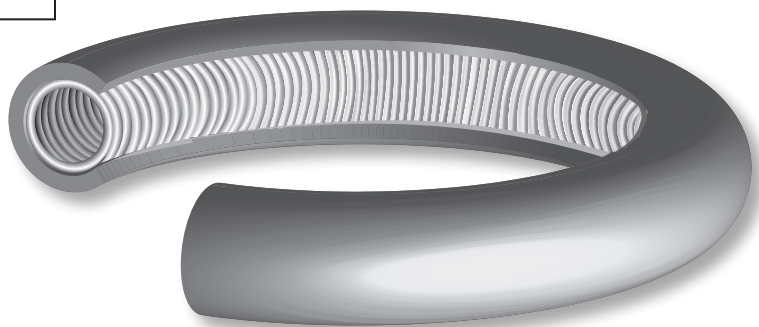

Section C  
Metal Seal Size Selection

Seal Dimensions				
Nominal Cross Section	Z	M	C	Cross Section Code
	Diametral Clearance	Maximum Radial Width	Free Height	
1/16	0.006	0.059	0.062 <sup>+0.003</sup> / <sub>-0.002</sub>	05
3/32	0.008	0.087	0.094 <sup>+0.004</sup> / <sub>-0.002</sub>	07
1/8	0.012	0.114	0.125 <sup>+0.004</sup> / <sub>-0.003</sub>	09
5/32	0.016	0.144	0.156 <sup>+0.004</sup> / <sub>-0.003</sub>	11
3/16	0.018	0.173	0.188 <sup>+0.005</sup> / <sub>-0.004</sub>	13
1/4	0.020	0.230	0.250 <sup>+0.006</sup> / <sub>-0.004</sub>	15
3/8	0.030	0.342	0.375 <sup>+0.008</sup> / <sub>-0.004</sub>	17
1/2	0.040	0.456	0.500 <sup>+0.010</sup> / <sub>-0.005</sub>	19

Performance		
Seating Load (pounds per inch circumference)	Springback (inches)	Working Pressure Rating (psi)
500	0.003	29000
850	0.005	23500
950	0.006	38000
1300	0.008	31000
1500	0.009	32500
2000	0.011	30000
2500	0.017	30500
2900	0.022	30000

All dimensions are in inches and prior to plating. Performance data is based on Alloy 750 jacket and spring. Seal performance is discussed in Section E. If working pressures exceed these ratings consult Parker for recommendations.

**WARNING**

These products can expose you to chemicals including carbon black (airborne and extracts), antimony trioxide, titanium dioxide, silica (crystalline), di(2-ethylhexyl)phthalate, ethylene thiourea, acrylonitrile, 1,3-butadiene, epichlorohydrin, toluene diisocyanate, tetrafluoroethylene, ethylbenzene, formaldehyde, furfuryl alcohol, glass fibers, methyl isobutyl ketone, nickel (metallic and compounds), lead and lead compounds which are known to the state of California to cause cancer; and 1,3-butadiene, epichlorohydrin, di(2-ethylhexyl)phthalate, di-isodecyl phthalate, ethylene thiourea, methyl isobutyl ketone, methanol, toluene, lead and lead compounds which are known to the state of California to cause birth defects and other reproductive harm. For more information go to [www.P65Warnings.ca.gov](http://www.P65Warnings.ca.gov).



## ESE Spring Energized Metal C-Ring External Pressure Face Seal

### Applications:

- Similar to ECE, but higher loads for use with rougher mating surfaces.
- Externally pressurized joints. Flanges with a rougher surface finish.
- Internally pressurized joints to avoid passage of working fluid into the seal cavity (reduced working pressure rating).

### Features:

- Lowest leak rate.
- Internal spring provides high pressure capabilities of up to 38,000 psi.
- All plating options available.
- Excellent footprint with good plastic flow of plating material.
- Available in any diameter from 0.650" to 120", plus hundreds of preferred sizes (see page E-90).
- Wide range of eight standard free heights from 1/16" to 1/2".
- Multiple material choices for high temperature strength, good spring-back, corrosion and fatigue resistance.
- Uses jacket forces, spring forces and hydrostatic forces additively to increase sealing forces at higher pressures when used with external pressurization.
- Circular, race-track and other custom shapes available. Tri-lobed or elliptical Spring Energized C-rings available for snap-in/snap-out convenience.

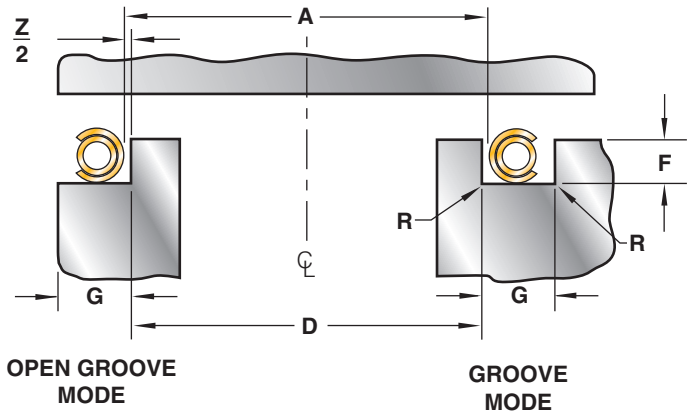

Cavity Dimensions				
Nominal Cross Section	D	F	G	R
	I.D. Range Tolerance h10	Depth Range	Minimum Width	Maximum Radius
1/16	0.650 – 8.000	0.050 – 0.054	0.090	0.015
3/32	0.900 – 16.000	0.075 – 0.079	0.125	0.020
1/8	1.000 – 24.000	0.100 – 0.105	0.160	0.030
5/32	1.250 – 30.000	0.125 – 0.130	0.200	0.050
3/16	3.000 – 36.000	0.151 – 0.157	0.250	0.050
1/4	4.000 – 72.000	0.200 – 0.208	0.350	0.060
3/8	12.000 – 120.000	0.300 – 0.316	0.500	0.060
1/2	24.0000 – 300.000	0.400 – 0.420	0.650	0.060

All dimensions are in inches.  
The tolerance reference table can be found on page E-92.

### ⚠ WARNING

These products can expose you to chemicals including carbon black (airborne and extracts), antimony trioxide, titanium dioxide, silica (crystalline), di(2-ethylhexyl)phthalate, ethylene thiourea, acrylonitrile, 1,3-butadiene, epichlorohydrin, toluene diisocyanate, tetrafluoroethylene, ethylbenzene, formaldehyde, furfuryl alcohol, glass fibers, methyl isobutyl ketone, nickel (metallic and compounds), lead and lead compounds which are known to the state of California to cause cancer; and 1,3-butadiene, epichlorohydrin, di(2-ethylhexyl)phthalate, di-isodecyl phthalate, ethylene thiourea, methyl isobutyl ketone, methanol, toluene, lead and lead compounds which are known to the state of California to cause birth defects and other reproductive harm. For more information go to [www.P65Warnings.ca.gov](http://www.P65Warnings.ca.gov).

**Part Numbering:**

Refer to Section A, page A-9 for part numbering convention. The seal size is specified in the part number as follows:

**ESE - 000000 - 00 - 00 - 0 - XXX**

Seal I.D. prior to plating (dimension A) to three decimal places. (Example: A 3.000 inch seal is specified as 003000)

Metal Seal Cross Section Code

Material (Section D)

Temper (Section D)

Plating, Coating or Finish (Section D)

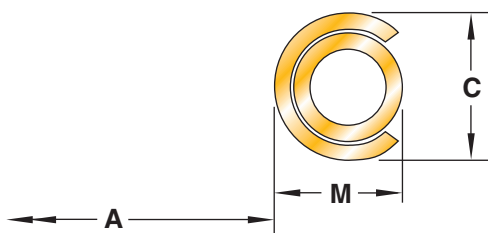

**Seal and Cavity Sizing:**

Seal free height is based on cavity diameter and depth alone. Seal diameter (dimension A) is derived below.

$$A = D + Z + 2P_{max}$$

(tolerance H11, see page E-92)

Where: D = Minimum cavity I.D.

Z = Diametral clearance between cavity and seal

P<sub>max</sub> = Maximum plating thickness (from page D-60)



Section C  
Metal Seal Size Selection

Seal Dimensions				
Nominal Cross Section	Z	M	C	Cross Section Code
	Diametral Clearance	Maximum Radial Width	Free Height	
1/16	0.006	0.059	0.062 <sup>+0.003</sup> / <sub>-0.002</sub>	05
3/32	0.008	0.087	0.094 <sup>+0.004</sup> / <sub>-0.002</sub>	07
1/8	0.012	0.114	0.125 <sup>+0.004</sup> / <sub>-0.002</sub>	09
5/32	0.016	0.144	0.156 <sup>+0.004</sup> / <sub>-0.002</sub>	11
3/16	0.018	0.173	0.188 <sup>+0.005</sup> / <sub>-0.004</sub>	13
1/4	0.020	0.230	0.250 <sup>+0.006</sup> / <sub>-0.004</sub>	15
3/8	0.030	0.342	0.375 <sup>+0.008</sup> / <sub>-0.004</sub>	17
1/2	0.040	0.456	0.500 <sup>+0.010</sup> / <sub>-0.005</sub>	19

Performance		
Seating Load (pounds per inch circumference)	Springback (inches)	Working Pressure Rating (psi)
500	0.003	29000
850	0.005	23500
950	0.006	38000
1300	0.008	31000
1500	0.009	32500
2000	0.011	30000
2500	0.017	30500
2900	0.022	30000

All dimensions are in inches. Performance data is based on Alloy X-750 jacket and spring. Seal performance is discussed in Section E. If working pressures exceed these ratings consult Parker for recommendations.

**WARNING**

These products can expose you to chemicals including carbon black (airborne and extracts), antimony trioxide, titanium dioxide, silica (crystalline), di(2-ethylhexyl)phthalate, ethylene thiourea, acrylonitrile, 1,3-butadiene, epichlorohydrin, toluene diisocyanate, tetrafluoroethylene, ethylbenzene, formaldehyde, furfuryl alcohol, glass fibers, methyl isobutyl ketone, nickel (metallic and compounds), lead and lead compounds which are known to the state of California to cause cancer; and 1,3-butadiene, epichlorohydrin, di(2-ethylhexyl)phthalate, di-isodecyl phthalate, ethylene thiourea, methyl isobutyl ketone, methanol, toluene, lead and lead compounds which are known to the state of California to cause birth defects and other reproductive harm. For more information go to [www.P65Warnings.ca.gov](http://www.P65Warnings.ca.gov).



# EEI Metal E-Ring Internal Pressure Face Seal

### Applications:

- High temperature pneumatic joints, turbine engine bleed air ducting joints, turbine engine cases, very low load flanges and/or joints with considerable movement.
- Multi-convolution E-rings available for very high deflection applications.
- Available internally pressure-energized or pressure neutral for reversing pressures.
- Resonant frequency of E-ring may be customized to avoid destructive resonance in high vibration applications.
- Available in standard sizes to fit all AS1895 flanges (refer to page C-44).
- For temperatures up to 1600°F.

### Features:

- Optimized one piece construction for lower costs.
- Highly compliant, very low load seal.
- Generally used unplated.
- Many custom cross sections available. See page F-98 for a selection of more popular styles.
- Diameters from 1.75" to 48" (larger on request).
- Radiused footprint area protects mating surfaces.
- Fully elastic working envelope for consistent performance over many compression/extension cycles.
- Defined fatigue life.
- Available in a choice of high strength/high temperature nickel and cobalt alloys.
- Available with HVOF (High Velocity Oxygen Flame) anti-wear coating.
- Electro deposited anti-wear coatings as well.

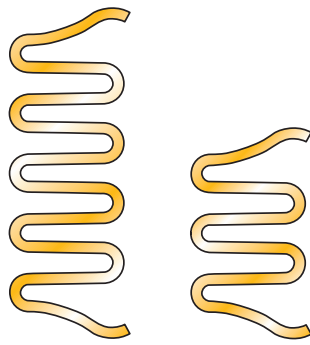
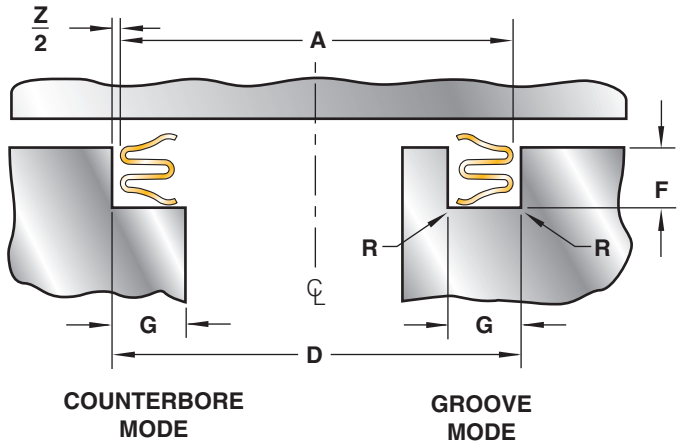
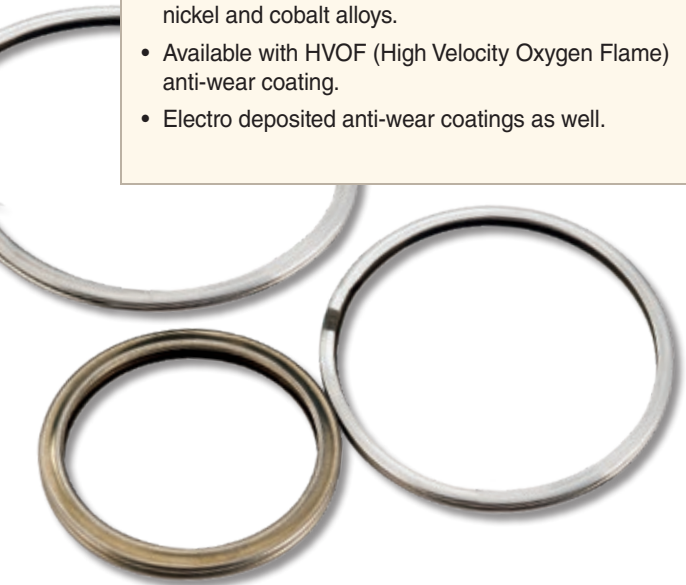

E-rings are available with additional convolutions for even greater springback.

See page F-98 for additional styles.

Cavity Dimensions				
Nominal Cross Section	D	F	G	R
	O.D. Range Tolerance H10	Depth Range	Minimum Width	Maximum Radius
1/16	1.750 – 8.000	0.061 – 0.063	0.090	0.015
	2.000 – 12.000	0.085 – 0.087	0.115	0.020
3/32	2.250 – 12.000	0.085 – 0.089	0.170	0.020
	2.000 – 12.000	0.085 – 0.089	0.115	0.020
1/8	2.000 – 24.000	0.116 – 0.120	0.165	0.030
	2.000 – 24.000	0.116 – 0.120	0.165	0.030
3/16	3.375 – 36.000	0.179 – 0.183	0.230	0.040
1/4	6.000 – 48.000	0.244 – 0.250	0.315	0.060

All dimensions are in inches.  
The tolerance reference table can be found on page E-92.

### ⚠ WARNING

These products can expose you to chemicals including carbon black (airborne and extracts), antimony trioxide, titanium dioxide, silica (crystalline), di(2-ethylhexyl)phthalate, ethylene thiourea, acrylonitrile, 1,3-butadiene, epichlorohydrin, toluene diisocyanate, tetrafluoroethylene, ethylbenzene, formaldehyde, furfuryl alcohol, glass fibers, methyl isobutyl ketone, nickel (metallic and compounds), lead and lead compounds which are known to the state of California to cause cancer; and 1,3-butadiene, epichlorohydrin, di(2-ethylhexyl)phthalate, di-isodecyl phthalate, ethylene thiourea, methyl isobutyl ketone, methanol, toluene, lead and lead compounds which are known to the state of California to cause birth defects and other reproductive harm. For more information go to [www.P65Warnings.ca.gov](http://www.P65Warnings.ca.gov).



**Part Numbering:**

Refer to Section A, page A-9 for part numbering convention. The seal size is specified in the part number as follows:

EEI - 000000 - 00 - 00 - 0 - XXX

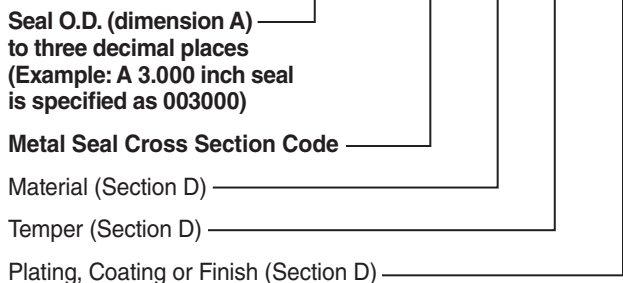

**Seal and Cavity Sizing:**

Seal free height is based on cavity diameter and depth alone. Seal diameter (dimension A) is derived below.

**A = D - Z**

(tolerance h11, see page E-92)

Where: D = Minimum cavity O.D.

Z = Diametral clearance between cavity and seal

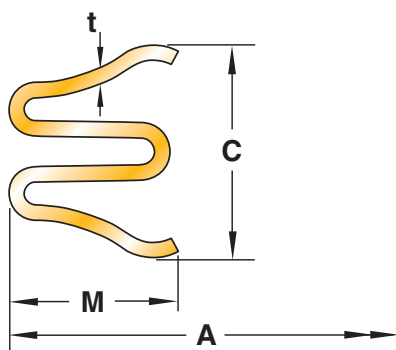

Section C  
Metal Seal Size Selection

Seal Dimensions					
Nominal Cross Section	Z	C	t	M	Cross Section Code
	Diametral Clearance	Free Height	Material Thickness	Maximum Radial Width	
1/16	0.003	0.074 ± 0.003	0.005	0.066	05
3/32	0.003	0.102 ± 0.005	0.010	0.091	06
		0.108 ± 0.005	0.010	0.145	07
		0.108 ± 0.005	0.010	0.091	08
		0.140 ± 0.004	0.012	0.122	10
1/8	0.005	0.132 ± 0.005	0.015	0.122	11
3/16	0.006	0.218 ± 0.005	0.015	0.190	13
1/4	0.008	0.295 ± 0.006	0.020	0.267	15

Performance		
Seating Load (pounds per inch circumference)	Springback (inches)	Working Pressure Rating (psi)
30	0.012	1500
30	0.015	1500
40	0.021	1500
90	0.018	5000
60	0.022	3500
75	0.014	5500
50	0.037	2000
80	0.048	2000

All dimensions are in inches. Performance data is based on Alloy 718 material with -6 temper. Seal performance is discussed in Section E. If working pressures exceed these ratings consult Parker for recommendations.

**WARNING**

These products can expose you to chemicals including carbon black (airborne and extracts), antimony trioxide, titanium dioxide, silica (crystalline), di(2-ethylhexyl)phthalate, ethylene thiourea, acrylonitrile, 1,3-butadiene, epichlorohydrin, toluene diisocyanate, tetrafluoroethylene, ethylbenzene, formaldehyde, furfuryl alcohol, glass fibers, methyl isobutyl ketone, nickel (metallic and compounds), lead and lead compounds which are known to the state of California to cause cancer; and 1,3-butadiene, epichlorohydrin, di(2-ethylhexyl)phthalate, di-isodecyl phthalate, ethylene thiourea, methyl isobutyl ketone, methanol, toluene, lead and lead compounds which are known to the state of California to cause birth defects and other reproductive harm. For more information go to [www.P65Warnings.ca.gov](http://www.P65Warnings.ca.gov).



# EEE Metal E-Rings External Pressure Face Seal

### Applications:

- High temperature pneumatic joints with external pressurization and/or joints with considerable movement.
- Multi-convolution E-rings available for very high deflection applications.
- Available externally pressure-energized or pressure neutral for reversing pressures.
- Resonant frequency of E-ring may be customized to avoid destructive resonance in high vibration applications.
- For temperatures up to 1600°F.

### Features:

- Optimized one piece construction for lower costs.
- Highly compliant, very low load seal.
- Generally used unplated.
- Many custom cross sections available. See page F-98 for a selection of more popular styles.
- Diameters from 1.75" to 48" (larger on request).
- Radiused footprint area protects mating surfaces.
- Fully elastic working envelope for consistent performance over many compression/extension cycles.
- Defined fatigue life.
- Available in a choice of high strength/high temperature nickel and cobalt alloys.
- Available with HVOF (High Velocity Oxygen Flame) anti-wear coating.
- Electro deposited anti-wear coatings as well.

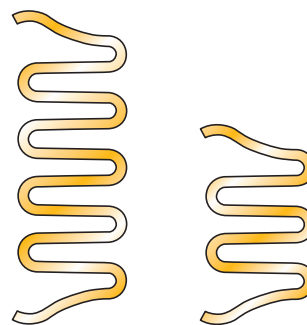
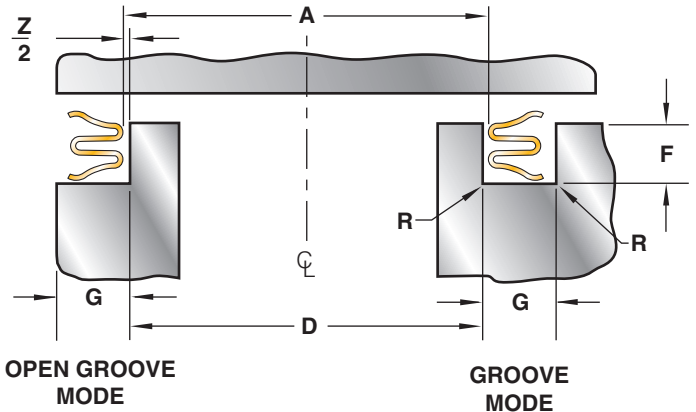

E-rings are available with additional convolutions for even greater springback.

See page F-98 for additional styles.

Cavity Dimensions				
Nominal Cross Section	D	F	G	R
	I.D. Range Tolerance h10	Depth Range	Minimum Width	Maximum Radius
1/16	1.750 – 8.000	0.061 – 0.063	0.090	0.015
	2.000 – 12.000	0.085 – 0.087	0.115	0.020
3/32	2.250 – 12.000	0.085 – 0.089	0.170	0.020
	2.000 – 12.000	0.085 – 0.089	0.115	0.020
1/8	2.000 – 24.000	0.116 – 0.120	0.165	0.030
	2.000 – 24.000	0.116 – 0.120	0.165	0.030
3/16	3.375 – 36.000	0.179 – 0.183	0.230	0.040
1/4	6.000 – 48.000	0.244 – 0.250	0.315	0.060

All dimensions are in inches.  
The tolerance reference table can be found on page E-92.

### ⚠ WARNING

These products can expose you to chemicals including carbon black (airborne and extracts), antimony trioxide, titanium dioxide, silica (crystalline), di(2-ethylhexyl)phthalate, ethylene thiourea, acrylonitrile, 1,3-butadiene, epichlorohydrin, toluene diisocyanate, tetrafluoroethylene, ethylbenzene, formaldehyde, furfuryl alcohol, glass fibers, methyl isobutyl ketone, nickel (metallic and compounds), lead and lead compounds which are known to the state of California to cause cancer; and 1,3-butadiene, epichlorohydrin, di(2-ethylhexyl)phthalate, di-isodecyl phthalate, ethylene thiourea, methyl isobutyl ketone, methanol, toluene, lead and lead compounds which are known to the state of California to cause birth defects and other reproductive harm. For more information go to [www.P65Warnings.ca.gov](http://www.P65Warnings.ca.gov).

**Part Numbering:**

Refer to Section A, page A-9 for part numbering convention. The seal size is specified in the part number as follows:

EEE - 000000 - 00 - 00 - 0 - XXX

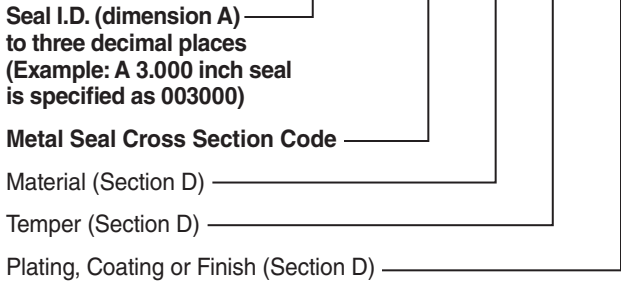

**Seal and Cavity Sizing:**

Seal free height is based on cavity diameter and depth alone. Seal diameter (dimension A) is derived below.

**A = D + Z**

(tolerance H11, see page E-92)

Where: D = Minimum cavity I.D.

Z = Diametral clearance between cavity and seal

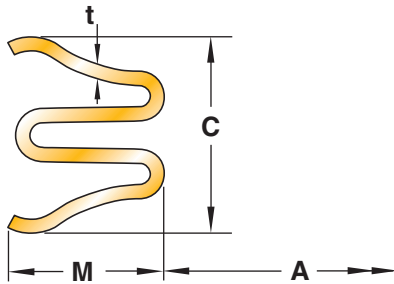

Section C  
Metal Seal Size Selection

Seal Dimensions					
Nominal Cross Section	Z	C	t	M	Cross Section Code
	Diametral Clearance	Free Height	Material Thickness	Maximum Radial Width	
1/16	0.003	0.074 ± 0.003	0.005	0.066	05
3/32	0.003	0.102 ± 0.005	0.010	0.091	06
		0.108 ± 0.005	0.010	0.145	07
		0.108 ± 0.005	0.010	0.091	08
		0.140 ± 0.004	0.012	0.122	10
1/8	0.005	0.132 ± 0.005	0.015	0.122	11
3/16	0.006	0.218 ± 0.005	0.015	0.190	13
1/4	0.008	0.295 ± 0.006	0.020	0.267	15

Performance		
Seating Load (pounds per inch circumference)	Springback (inches)	Working Pressure Rating (psi)
30	0.012	1500
30	0.015	1500
40	0.021	1500
90	0.018	5000
60	0.022	3500
75	0.014	5500
50	0.037	2000
80	0.048	2000

All dimensions are in inches and prior to plating. Performance data is based on Alloy 718 material with -6 treatment. Seal performance is discussed in Section E. If working pressures exceed these ratings consult Parker for recommendations.

**WARNING**

These products can expose you to chemicals including carbon black (airborne and extracts), antimony trioxide, titanium dioxide, silica (crystalline), di(2-ethylhexyl)phthalate, ethylene thiourea, acrylonitrile, 1,3-butadiene, epichlorohydrin, toluene diisocyanate, tetrafluoroethylene, ethylbenzene, formaldehyde, furfuryl alcohol, glass fibers, methyl isobutyl ketone, nickel (metallic and compounds), lead and lead compounds which are known to the state of California to cause cancer; and 1,3-butadiene, epichlorohydrin, di(2-ethylhexyl)phthalate, di-isodecyl phthalate, ethylene thiourea, methyl isobutyl ketone, methanol, toluene, lead and lead compounds which are known to the state of California to cause birth defects and other reproductive harm. For more information go to [www.P65Warnings.ca.gov](http://www.P65Warnings.ca.gov).



# EOI, EON & EOP Metal O-Rings Internal Pressure Face Seal

### Applications:

- Heavy joints with minimum movement.
- Static, low leakage face sealing.
- Contiguous sealing surface permits use within triple-surface, chamfered joints and non-rectangular section grooves.

### Features:

- Many tubing material choices and plating options available for widest media compatibility.
- Standard metal O-rings available for all 'MS' sizes and configurations (see pages C-45 to C-50).
- All welds are 100% fluorescent penetrant inspected.
- Eight standard free heights and any diameter from 0.250" to 25'.
- High sealing load creates excellent plating compression and superior sealing.
- Robust, high integrity seal for ease of handling, even in largest sizes.

### Selection of Types:

**EOI (preferred):** Internally vented and pressure-energized: recommended for high pressures. (Refer to performance table on facing page).

**EON\* (preferred):** Non-vented, non-filled: avoids ingress of working fluid(s) into the seal, lowest cost, but pressure capability is reduced. (Refer to performance table on facing page).

**EOP\* (optional):** Non-vented, gas pressure-filled. Good for bi-directional (reversing) pressures. Avoids ingress of working fluid(s) into the seal. Enhances load at high temperatures.

\*Not for use in applications with a very high ambient pressure (drill string equipment and undersea applications).

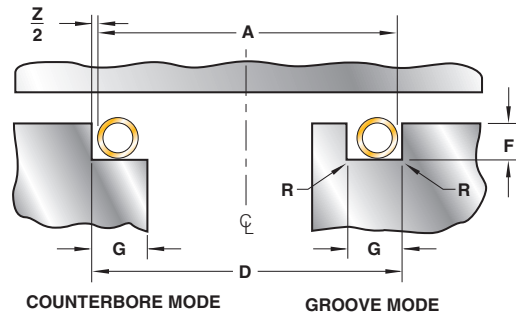

Cavity Dimensions				
Nominal Cross Section	D	F	G	R
	O.D. Range Tolerance H10	Depth Range	Minimum Width	Maximum Radius
1/32	0.250 – 1.000	0.025 – 0.027	0.055	0.010
3/64	0.400 – 2.000	0.037 – 0.040	0.070	0.012
1/16	0.500 – 8.000	0.045 – 0.050	0.090	0.015
3/32	1.000 – 16.000	0.074 – 0.079	0.125	0.020
1/8	1.500 – 24.000	0.100 – 0.105	0.160	0.030
5/32	3.000 – 30.000	0.125 – 0.130	0.200	0.050
3/16	4.000 – 36.000	0.151 – 0.157	0.250	0.050
1/4	8.000 – 48.000	0.200 – 0.208	0.350	0.060

All dimensions are in inches.  
The tolerance reference table can be found on page E-92.

### WARNING

These products can expose you to chemicals including carbon black (airborne and extracts), antimony trioxide, titanium dioxide, silica (crystalline), di(2-ethylhexyl)phthalate, ethylene thiourea, acrylonitrile, 1,3-butadiene, epichlorohydrin, toluene diisocyanate, tetrafluoroethylene, ethylbenzene, formaldehyde, furfuryl alcohol, glass fibers, methyl isobutyl ketone, nickel (metallic and compounds), lead and lead compounds which are known to the state of California to cause cancer; and 1,3-butadiene, epichlorohydrin, di(2-ethylhexyl)phthalate, di-isodecyl phthalate, ethylene thiourea, methyl isobutyl ketone, methanol, toluene, lead and lead compounds which are known to the state of California to cause birth defects and other reproductive harm. For more information go to [www.P65Warnings.ca.gov](http://www.P65Warnings.ca.gov).

**Part Numbering:**

Refer to Section A, page A-9 for part numbering convention. The seal size is specified in the part number as follows:

**EO [I, N, P] - 000000 - 00 - 00 - 0 - XXX**

Seal O.D. prior to plating (dimension A) to three decimal places. (Example: A 3.000 inch seal is specified as 003000)

Metal Seal Cross Section Code

Material (Section D)

Temper (Section D)

Plating, Coating or Finish (Section D)

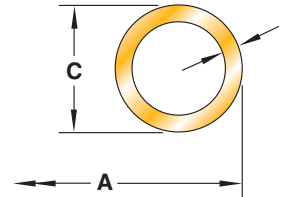

**Seal and Cavity Sizing:**

Seal free height is based on cavity diameter and depth alone. Seal diameter (dimension A) is derived below.

Seal Tolerance	
Free Height	Seal Diameter Tolerance (-0.000)
0.035 - 0.188	+0.005
0.250	+0.008
0.375 - 0.625	+0.010

$$A = D - Z - 2P_{max}$$

Where: D = Minimum cavity O.D.

Z = Diametral clearance between cavity and seal

P<sub>max</sub> = Maximum plating thickness (from page D-60)

Seal Dimensions				
Nominal Cross Section	Z	C	t	Cross Section Code
	Diametral Clearance	Free Height	Material Thickness	
1/32	0.007	0.035 +0.003 -0.001	0.006	01
3/64	0.008	0.047 +0.003 -0.001	0.007	29
1/16	0.008	0.062 +0.003 -0.001	0.006	02
			0.010	03
			0.012	31
			0.014	08
3/32	0.009	0.094 +0.003 -0.001	0.006	04
			0.010	05
			0.012	32
			0.018	09
1/8	0.011	0.125 +0.003 -0.001	0.008	06
			0.010	07
			0.012	25
			0.020	10
5/32	0.013	0.156 +0.004 -0.000	0.016	11
			0.020	12
3/16	0.014	0.188 +0.005 -0.000	0.020	13
			0.025	14
1/4	0.018	0.250 +0.005 -0.000	0.025	15
			0.032	16

Performance							
Seating Load (pounds/inch circ.)		Springback (inches)		Working Pressure Rating (psi)			
				Vented		Non-Vented	
304SS/321SS	Alloy X-750/Alloy 718	304SS/321SS	Alloy X-750/Alloy 718	304SS/321SS	Alloy X-750/Alloy 718	304SS/321SS	Alloy X-750/Alloy 718
400	550	0.0005	0.0005	10000	15000	700	1000
400	550	0.001	0.001	7000	10000	700	1000
260	350	0.0015	0.002	4000	6500	600	900
550	750	0.001	0.0015	11000	16000	700	1000
800	1100	0.001	0.001	14000	20000	700	1100
1100	1500	0.001	0.001	17000	25000	800	1200
150	200	0.002	0.002	1400	2000	700	1000
300	400	0.002	0.002	4000	6500	800	1100
400	550	0.001	0.0015	6500	10000	800	1200
1200	1600	0.001	0.0015	16500	25000	900	1300
100	140	0.004	0.005	2500	4000	500	700
150	200	0.003	0.004	4500	6500	500	800
280	400	0.002	0.003	6500	10000	600	900
900	1200	0.002	0.002	16500	25000	700	1000
400	550	0.004	0.005	4000	6500	700	1000
750	1000	0.003	0.004	13500	20000	700	1100
450	600	0.004	0.005	4000	6500	700	1000
700	950	0.003	0.004	14500	22000	700	1100
450	600	0.005	0.006	4000	6000	700	1000
950	1300	0.004	0.005	13500	20500	700	1100

All dimensions are in inches and prior to plating. Performance data is based on Alloy 718 material with -6 treatment. Seal performance is discussed in Section E. If working pressures exceed these ratings consult Parker for recommendations.

**WARNING**

These products can expose you to chemicals including carbon black (airborne and extracts), antimony trioxide, titanium dioxide, silica (crystalline), di(2-ethylhexyl)phthalate, ethylene thiourea, acrylonitrile, 1,3-butadiene, epichlorohydrin, toluene diisocyanate, tetrafluoroethylene, ethylbenzene, formaldehyde, furfuryl alcohol, glass fibers, methyl isobutyl ketone, nickel (metallic and compounds), lead and lead compounds which are known to the state of California to cause cancer; and 1,3-butadiene, epichlorohydrin, di(2-ethylhexyl)phthalate, di-isodecyl phthalate, ethylene thiourea, methyl isobutyl ketone, methanol, toluene, lead and lead compounds which are known to the state of California to cause birth defects and other reproductive harm. For more information go to [www.P65Warnings.ca.gov](http://www.P65Warnings.ca.gov).



# EOE, EOM & EOR Metal O-Rings External Pressure Face Seal

### Applications:

- Heavy joints with minimum movement.
- Static, low leakage face sealing.
- Contiguous sealing surface permits use within triple-surface, chamfered joints and non-rectangular section grooves.

### Features:

- Many tubing material choices and plating options available for widest media compatibility.
- All welds are 100% fluorescent penetrant inspected.
- Eight standard free heights and any diameter from 0.180" to 25'.
- High sealing load creates excellent plating compression and superior sealing.
- Robust, high integrity seal for ease of handling, even in largest sizes.

### Selection of Types:

**EOE (preferred):** Externally vented and pressure-energized: recommended for high pressures. (Refer to performance table on facing page).

**EOM\* (preferred):** Non-vented, non-filled: avoids ingress of working fluid(s) into the seal, lowest cost, but reduces pressure capability. (Refer to performance table on facing page).

**EOR\* (optional):** Non-vented, gas pressure-filled. Good for bi-directional (reversing) pressures. Avoids ingress of working fluid(s) into the seal. Enhances load at high temperatures.

\*Not for use in applications with a very high ambient pressure (drill string equipment and undersea applications).

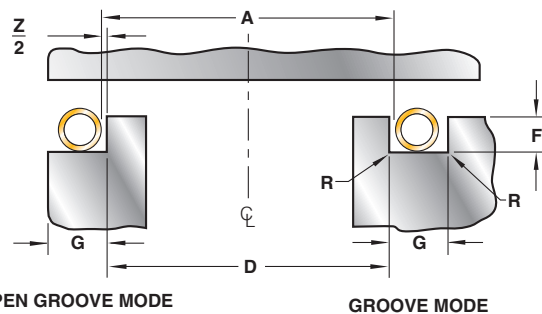

Cavity Dimensions				
Nominal Cross Section	D	F	G	R
	I.D. Range Tolerance h10	Depth Range	Minimum Width	Maximum Radius
1/32	0.180 – 1.000	0.025 – 0.027	0.055	0.010
3/64	0.300 – 2.000	0.037 – 0.040	0.070	0.012
1/16	0.375 – 8.000	0.045 – 0.050	0.090	0.015
3/32	0.800 – 16.000	0.074 – 0.079	0.125	0.020
1/8	1.250 – 24.000	0.100 – 0.105	0.160	0.030
5/32	2.750 – 30.000	0.125 – 0.130	0.200	0.050
3/16	3.750 – 36.000	0.151 – 0.157	0.250	0.050
1/4	7.500 – 48.000	0.200 – 0.208	0.350	0.060

All dimensions are in inches.  
The tolerance reference table can be found on page E-92.

### WARNING

These products can expose you to chemicals including carbon black (airborne and extracts), antimony trioxide, titanium dioxide, silica (crystalline), di(2-ethylhexyl)phthalate, ethylene thiourea, acrylonitrile, 1,3-butadiene, epichlorohydrin, toluene diisocyanate, tetrafluoroethylene, ethylbenzene, formaldehyde, furfuryl alcohol, glass fibers, methyl isobutyl ketone, nickel (metallic and compounds), lead and lead compounds which are known to the state of California to cause cancer; and 1,3-butadiene, epichlorohydrin, di(2-ethylhexyl)phthalate, di-isodecyl phthalate, ethylene thiourea, methyl isobutyl ketone, methanol, toluene, lead and lead compounds which are known to the state of California to cause birth defects and other reproductive harm. For more information go to [www.P65Warnings.ca.gov](http://www.P65Warnings.ca.gov).

**Part Numbering:**

Refer to Section A, page A-9 for part numbering convention. The seal size is specified in the part number as follows:

**EO [E, M, R] - 000000 - 00 - 00 - 0 - XXX**

Seal I.D. prior to plating (dimension A) to three decimal places. (Example: A 3.000 inch seal is specified as 003000)

Metal Seal Cross Section Code

Material (Section D)

Temper (Section D)

Plating, Coating or Finish (Section D)



**Seal and Cavity Sizing:**

Seal free height is based on cavity diameter and depth alone. Seal diameter (dimension A) is derived below.

Seal Tolerance	
Free Height	Seal Diameter Tolerance (-0.000)
0.035 - 0.188	+0.005
0.250	+0.008
0.375 - 0.625	+0.010

$$A = D - Z - 2P_{max}$$

Where: D = Minimum cavity I.D.

Z = Diametral clearance between cavity and seal

P<sub>max</sub> = Maximum plating thickness (from page D-60)

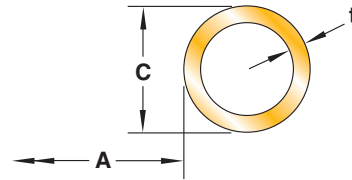

Seal Dimensions				
Nominal Cross Section	Z	C	t	Cross Section Code
	Diametral Clearance	Free Height	Material Thickness	
1/32	0.007	0.035 <sup>+0.003</sup> <sub>-0.001</sub>	0.006	01
3/64	0.008	0.047 <sup>+0.003</sup> <sub>-0.001</sub>	0.007	29
1/16	0.008	0.062 <sup>+0.003</sup> <sub>-0.001</sub>	0.006	02
			0.010	03
			0.012	31
			0.014	08
3/32	0.009	0.094 <sup>+0.003</sup> <sub>-0.001</sub>	0.006	04
			0.010	05
			0.012	32
			0.018	09
1/8	0.011	0.125 <sup>+0.003</sup> <sub>-0.001</sub>	0.008	06
			0.010	07
			0.012	25
			0.020	10
5/32	0.013	0.156 <sup>+0.004</sup> <sub>-0.000</sub>	0.016	11
			0.020	12
3/16	0.014	0.188 <sup>+0.005</sup> <sub>-0.000</sub>	0.020	13
			0.025	14
1/4	0.018	0.250 <sup>+0.005</sup> <sub>-0.000</sub>	0.025	15
			0.032	16

Performance							
Seating Load (pounds/inch circ.)		Springback (inches)		Working Pressure Rating (psi)			
				Vented		Non-Vented	
304SS/321SS	Alloy X-750/Alloy 718	304SS/321SS	Alloy X-750/Alloy 718	304SS/321SS	Alloy X-750/Alloy 718	304SS/321SS	Alloy X-750/Alloy 718
400	550	0.0005	0.0005	10000	15000	700	1000
400	550	0.001	0.001	7000	10000	700	1000
260	350	0.0015	0.002	4000	6500	600	900
550	750	0.001	0.0015	11000	16000	700	1000
800	1100	0.001	0.001	14000	20000	700	1100
1100	1500	0.001	0.001	17000	25000	800	1200
150	200	0.002	0.002	1400	2000	700	1000
300	400	0.002	0.002	4000	6500	800	1100
400	550	0.001	0.0015	6500	10000	800	1200
1200	1600	0.001	0.0015	16500	25000	900	1300
100	140	0.004	0.005	2500	4000	500	700
150	200	0.003	0.004	4500	6500	500	800
280	400	0.002	0.003	6500	10000	600	900
900	1200	0.002	0.002	16500	25000	700	1000
400	550	0.004	0.005	4000	6500	700	1000
750	1000	0.003	0.004	13500	20000	700	1100
450	600	0.004	0.005	4000	6500	700	1000
700	950	0.003	0.004	14500	22000	700	1100
450	600	0.005	0.006	4000	6000	700	1000
950	1300	0.004	0.005	13500	20500	700	1100

All dimensions are in inches and prior to plating.

Performance data is based on Alloy 718 material with -6 treatment. Seal performance is discussed in Section E.

If working pressures exceed these ratings consult Parker for recommendations.

**WARNING**

These products can expose you to chemicals including carbon black (airborne and extracts), antimony trioxide, titanium dioxide, silica (crystalline), di(2-ethylhexyl)phthalate, ethylene thiourea, acrylonitrile, 1,3-butadiene, epichlorohydrin, toluene diisocyanate, tetrafluoroethylene, ethylbenzene, formaldehyde, furfuryl alcohol, glass fibers, methyl isobutyl ketone, nickel (metallic and compounds), lead and lead compounds which are known to the state of California to cause cancer; and 1,3-butadiene, epichlorohydrin, di(2-ethylhexyl)phthalate, di-isodecyl phthalate, ethylene thiourea, methyl isobutyl ketone, methanol, toluene, lead and lead compounds which are known to the state of California to cause birth defects and other reproductive harm. For more information go to [www.P65Warnings.ca.gov](http://www.P65Warnings.ca.gov).



## EUI Metal U-Ring Internal Pressure Face Seal

### Applications:

- High temperature joints with significant movement.
- Up to 1600°F.
- Retrofittable in (3/32" cross section and larger) metal O-ring grooves for lower load and greater springback.

### Features:

- Compliant low load seal, generally used unplated.
- Strongly pressure energized.
- Four standard sections and any diameter from 1.75" to 48".
- Radiused footprint area protects mating surfaces.
- Well supported heel and sides ensure highest pressure capability.
- Good all round performance, economically priced.

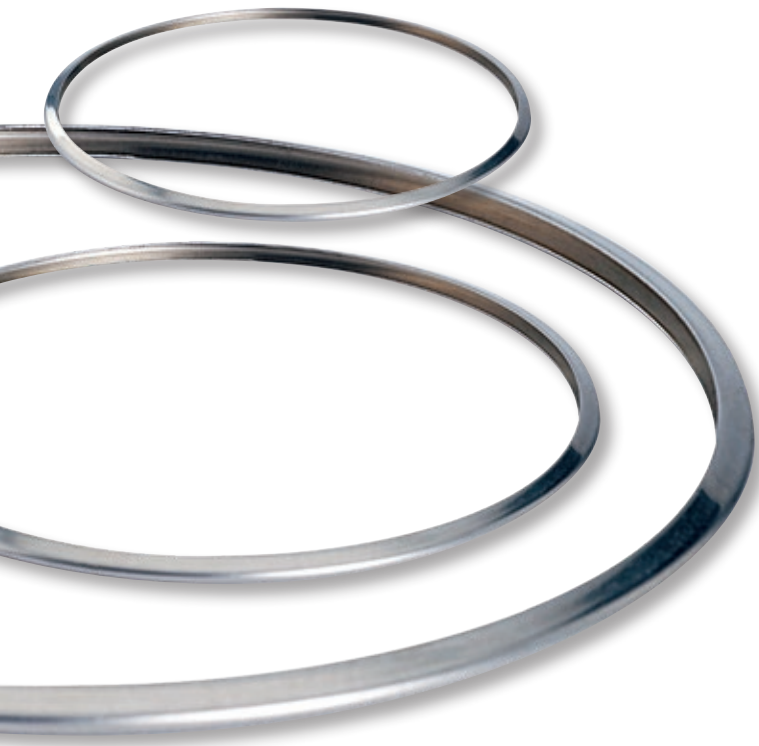
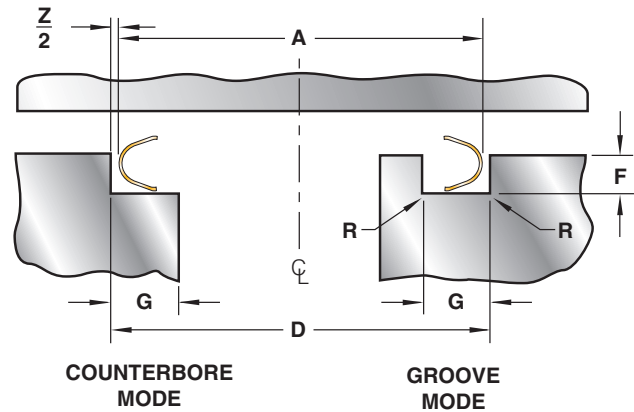

**Cavity Dimensions**

Nominal Cross Section	D	F	G	R
	O.D. Range Tolerance H10	Depth Range	Minimum Width	Maximum Radius
3/32	2.250 – 16.000	0.074 – 0.080	0.125	0.020
1/8	2.500 – 24.000	0.100 – 0.107	0.160	0.030
3/16	3.375 – 36.000	0.150 – 0.157	0.250	0.050
1/4	6.000 – 48.000	0.200 – 0.208	0.350	0.060

All dimensions are in inches.  
The tolerance reference table can be found on page E-92.

### ⚠ WARNING

These products can expose you to chemicals including carbon black (airborne and extracts), antimony trioxide, titanium dioxide, silica (crystalline), di(2-ethylhexyl)phthalate, ethylene thiourea, acrylonitrile, 1,3-butadiene, epichlorohydrin, toluene diisocyanate, tetrafluoroethylene, ethylbenzene, formaldehyde, furfuryl alcohol, glass fibers, methyl isobutyl ketone, nickel (metallic and compounds), lead and lead compounds which are known to the state of California to cause cancer; and 1,3-butadiene, epichlorohydrin, di(2-ethylhexyl)phthalate, di-isodecyl phthalate, ethylene thiourea, methyl isobutyl ketone, methanol, toluene, lead and lead compounds which are known to the state of California to cause birth defects and other reproductive harm. For more information go to [www.P65Warnings.ca.gov](http://www.P65Warnings.ca.gov).



**Part Numbering:**

Refer to Section A, page A-9 for part numbering convention. The seal size is specified in the part number as follows:

EUI - 000000 - 00 - 00 - 0

Seal O.D. (dimension A) to three decimal places. (Example: A 3.000 inch seal is specified as 003000)

Metal Seal Cross Section Code

Material (Section D)

Temper (Section D)

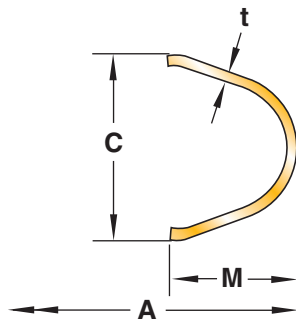

**Seal and Cavity Sizing:**

Seal free height is based on cavity diameter and depth alone. Seal diameter (dimension A) is derived below.

**A = D - Z**

(tolerance h11, see page E-92)

Where: D = Minimum cavity O.D.

Z = Diametral clearance between cavity and seal



Section C  
Metal Seal Size Selection

Seal Dimensions					
Nominal Cross Section	Z	C	t	M	Cross Section Code
	Diametral Clearance	Free Height	Material Thickness	Maximum Radial Width	
3/32	0.003	0.093 ± 0.004	0.010	0.098	07
1/8	0.005	0.125 ± 0.005	0.012	0.131	09
3/16	0.006	0.185 ± 0.005	0.015	0.198	13
1/4	0.008	0.247 ± 0.006	0.020	0.262	15

Performance		
Seating Load (pounds per inch circumference)	Springback (inches)	Working* Pressure Rating (psi)
45	0.010	12000
50	0.014	12000
50	0.020	8000
70	0.026	8000

All dimensions are in inches. Performance data is based on Alloy 718 material with -6 treatment. Seal performance is discussed in Section E. \*If working pressures exceed these ratings consult Parker for recommendations.

**WARNING**

These products can expose you to chemicals including carbon black (airborne and extracts), antimony trioxide, titanium dioxide, silica (crystalline), di(2-ethylhexyl)phthalate, ethylene thiourea, acrylonitrile, 1,3-butadiene, epichlorohydrin, toluene diisocyanate, tetrafluoroethylene, ethylbenzene, formaldehyde, furfuryl alcohol, glass fibers, methyl isobutyl ketone, nickel (metallic and compounds), lead and lead compounds which are known to the state of California to cause cancer; and 1,3-butadiene, epichlorohydrin, di(2-ethylhexyl)phthalate, di-isodecyl phthalate, ethylene thiourea, methyl isobutyl ketone, methanol, toluene, lead and lead compounds which are known to the state of California to cause birth defects and other reproductive harm. For more information go to [www.P65Warnings.ca.gov](http://www.P65Warnings.ca.gov).



## EUE Metal U-Ring External Pressure Face Seal

### Applications:

- High temperature joints with significant movement.
- Up to 1600°F.
- Retrofittable in (3/32" cross section and larger) metal O-ring grooves for lower load and greater springback.

### Features:

- Compliant low load seal, generally used unplated.
- Strongly pressure energized.
- Four standard sections and any diameter from 1.75" to 48".
- Radiused footprint area protects mating surfaces.
- Well supported heel and sides ensure highest pressure capability.
- Good all round performance, economically priced.

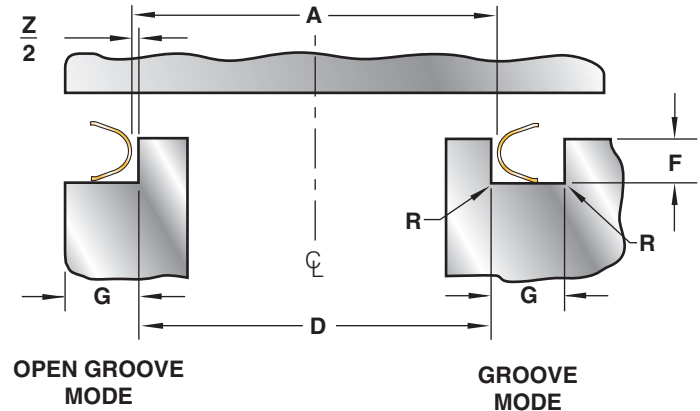

**Cavity Dimensions**

Nominal Cross Section	D	F	G	R
	I.D. Range Tolerance h10	Depth Range	Minimum Width	Maximum Radius
3/32	2.250 – 16.000	0.074 – 0.080	0.125	0.020
1/8	2.500 – 24.000	0.100 – 0.107	0.160	0.030
3/16	3.375 – 36.000	0.150 – 0.157	0.250	0.050
1/4	6.000 – 48.000	0.200 – 0.208	0.350	0.060

All dimensions are in inches.  
The tolerance reference table can be found on page E-92.

### ⚠ WARNING

These products can expose you to chemicals including carbon black (airborne and extracts), antimony trioxide, titanium dioxide, silica (crystalline), di(2-ethylhexyl)phthalate, ethylene thiourea, acrylonitrile, 1,3-butadiene, epichlorohydrin, toluene diisocyanate, tetrafluoroethylene, ethylbenzene, formaldehyde, furfuryl alcohol, glass fibers, methyl isobutyl ketone, nickel (metallic and compounds), lead and lead compounds which are known to the state of California to cause cancer; and 1,3-butadiene, epichlorohydrin, di(2-ethylhexyl)phthalate, di-isodecyl phthalate, ethylene thiourea, methyl isobutyl ketone, methanol, toluene, lead and lead compounds which are known to the state of California to cause birth defects and other reproductive harm. For more information go to [www.P65Warnings.ca.gov](http://www.P65Warnings.ca.gov).

**Part Numbering:**

Refer to Section A, page A-9 for part numbering convention. The seal size is specified in the part number as follows:

**EUE - 000000 - 00 - 00 - 0**

Seal I.D. (dimension A) to three decimal places. (Example: A 3.000 inch seal is specified as 003000)

Metal Seal Cross Section Code

Material (Section D)

Temper (Section D)

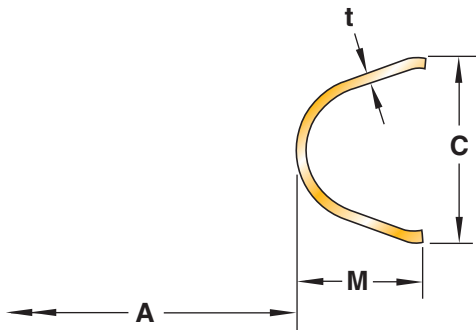

**Seal and Cavity Sizing:**

Seal free height is based on cavity diameter and depth alone. Seal diameter (dimension A) is derived below.

**A = D + Z**

(tolerance H11, see page E-92)

Where: D = Minimum cavity I.D.

Z = Diametral clearance between cavity and seal



Section C  
Metal Seal Size Selection

Seal Dimensions					
Nominal Cross Section	Z	C	t	M	Cross Section Code
	Diametral Clearance	Free Height	Material Thickness	Maximum Radial Width	
3/32	0.003	0.093 ± 0.004	0.010	0.098	07
1/8	0.005	0.125 ± 0.005	0.012	0.131	09
3/16	0.006	0.185 ± 0.005	0.015	0.198	13
1/4	0.008	0.247 ± 0.006	0.020	0.262	15

Performance		
Seating Load (pounds per inch circumference)	Springback (inches)	Working Pressure Rating (psi)
45	0.010	12000
50	0.014	12000
50	0.020	8000
70	0.026	8000

All dimensions are in inches. Performance data is based on Alloy 718 material with -6 treatment. Seal performance is discussed in Section E. If working pressures exceed these ratings consult Parker for recommendations.

**WARNING**

These products can expose you to chemicals including carbon black (airborne and extracts), antimony trioxide, titanium dioxide, silica (crystalline), di(2-ethylhexyl)phthalate, ethylene thiourea, acrylonitrile, 1,3-butadiene, epichlorohydrin, toluene diisocyanate, tetrafluoroethylene, ethylbenzene, formaldehyde, furfuryl alcohol, glass fibers, methyl isobutyl ketone, nickel (metallic and compounds), lead and lead compounds which are known to the state of California to cause cancer; and 1,3-butadiene, epichlorohydrin, di(2-ethylhexyl)phthalate, di-isodecyl phthalate, ethylene thiourea, methyl isobutyl ketone, methanol, toluene, lead and lead compounds which are known to the state of California to cause birth defects and other reproductive harm. For more information go to [www.P65Warnings.ca.gov](http://www.P65Warnings.ca.gov).



## EWI Metal Wire Ring Internal Pressure Face Seal

### Applications:

- Low cost, high load 'crush' sealing.
- Contiguous sealing surface permits use within triple-surface, chamfered joints and non-rectangular section grooves.
- Best with rigid mating surfaces with minimum relative movement.
- Small process valves.
- Fits standard metal O-ring grooves.

### Features:

- Wide variety of material options.
- High pressure rating.
- Many other custom cross sections are available.

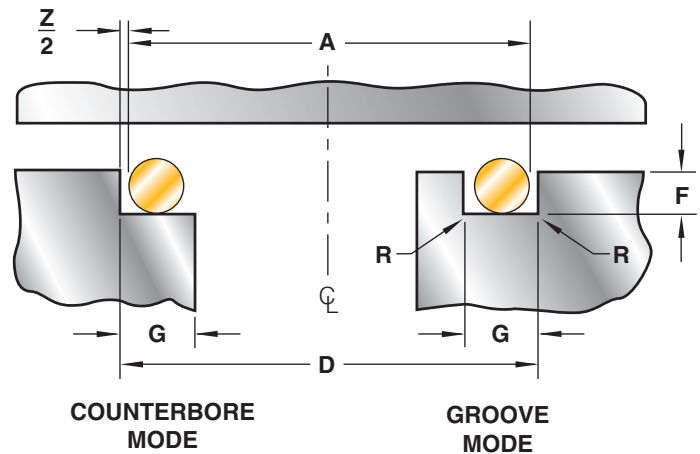

Cavity Dimensions				
Nominal Cross Section	D	F	G	R
	O.D. Range Tolerance H10	Depth Range	Minimum Width	Maximum Radius
1/32	0.250 – 1.000	0.025 – 0.027	0.055	0.010
1/16	0.500 – 8.000	0.045 – 0.050	0.090	0.015
3/32	1.000 – 16.000	0.074 – 0.079	0.150	0.020
1/8	1.500 – 24.000	0.100 – 0.105	0.160	0.030

All dimensions are in inches.  
The tolerance reference table can be found on page E-92.

### ⚠ WARNING

These products can expose you to chemicals including carbon black (airborne and extracts), antimony trioxide, titanium dioxide, silica (crystalline), di(2-ethylhexyl)phthalate, ethylene thiourea, acrylonitrile, 1,3-butadiene, epichlorohydrin, toluene diisocyanate, tetrafluoroethylene, ethylbenzene, formaldehyde, furfuryl alcohol, glass fibers, methyl isobutyl ketone, nickel (metallic and compounds), lead and lead compounds which are known to the state of California to cause cancer; and 1,3-butadiene, epichlorohydrin, di(2-ethylhexyl)phthalate, di-isodecyl phthalate, ethylene thiourea, methyl isobutyl ketone, methanol, toluene, lead and lead compounds which are known to the state of California to cause birth defects and other reproductive harm. For more information go to [www.P65Warnings.ca.gov](http://www.P65Warnings.ca.gov).

**Part Numbering:**

Refer to Section A, page A-9 for part numbering convention. The seal size is specified in the part number as follows:

EWI - **000000** - **00** - **00** - **0**

Seal O.D. (dimension A) to three decimal places. (Example: A 3.000 inch seal is specified as 003000)

Metal Seal Cross Section Code

Material (Section D)

Temper (Section D)

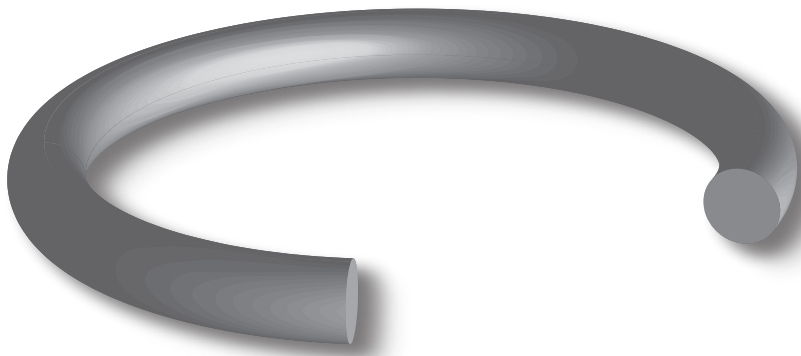
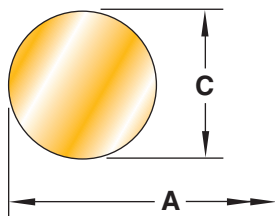

**Seal and Cavity Sizing:**

Seal free height is based on cavity diameter and depth alone. Seal diameter (dimension A) is derived below.

**A = D - Z**

(tolerance ± 0.005)

Where: D = Minimum cavity O.D.

Z = Diametral clearance between cavity and seal

Section C  
Metal Seal Size Selection

Seal Dimensions			
Nominal Cross Section	Z	C	Cross Section Code
	Diametral Clearance	Free Height	
1/32	0.008	0.035 <sup>+0.003</sup> / <sub>-0.001</sub>	03
1/16	0.011	0.062 <sup>+0.003</sup> / <sub>-0.001</sub>	05
3/32	0.013	0.094 <sup>+0.003</sup> / <sub>-0.001</sub>	06
1/8	0.017	0.125 <sup>+0.003</sup> / <sub>-0.001</sub>	07

Performance		
Seating Load (pounds per inch circumference)	Springback (inches)	Working Pressure Rating (psi)
4200	0	20000
6000	0.0005	20000
6000	0.001	20000
6000	0.002	20000

All dimensions are in inches. Performance data is based on annealed 304 Stainless Steel. Seal performance is discussed in Section E.

**WARNING**

These products can expose you to chemicals including carbon black (airborne and extracts), antimony trioxide, titanium dioxide, silica (crystalline), di(2-ethylhexyl)phthalate, ethylene thiourea, acrylonitrile, 1,3-butadiene, epichlorohydrin, toluene diisocyanate, tetrafluoroethylene, ethylbenzene, formaldehyde, furfuryl alcohol, glass fibers, methyl isobutyl ketone, nickel (metallic and compounds), lead and lead compounds which are known to the state of California to cause cancer; and 1,3-butadiene, epichlorohydrin, di(2-ethylhexyl)phthalate, di-isodecyl phthalate, ethylene thiourea, methyl isobutyl ketone, methanol, toluene, lead and lead compounds which are known to the state of California to cause birth defects and other reproductive harm. For more information go to [www.P65Warnings.ca.gov](http://www.P65Warnings.ca.gov).



## EWE Metal Wire Ring External Pressure Face Seal

### Applications:

- Low cost, high load 'crush' sealing.
- Contiguous sealing surface permits use within triple-surface, chamfered joints and non-rectangular section grooves.
- Best with rigid mating surfaces with minimum relative movement.
- Small process valves.
- Fits standard metal O-ring grooves.

### Features:

- High pressure rating.
- Many other custom cross sections are available. Contact your local representative.

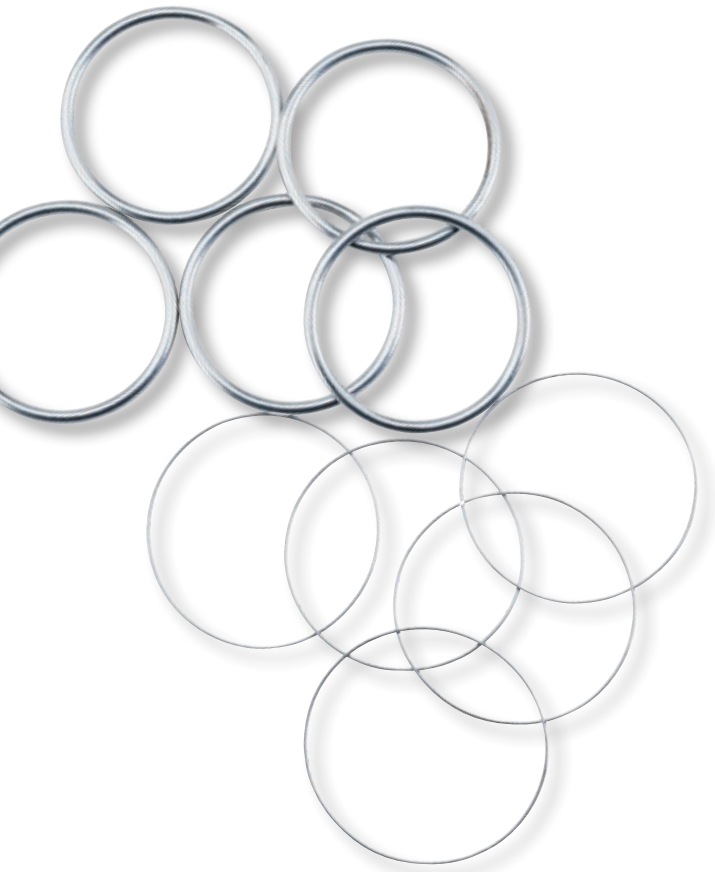
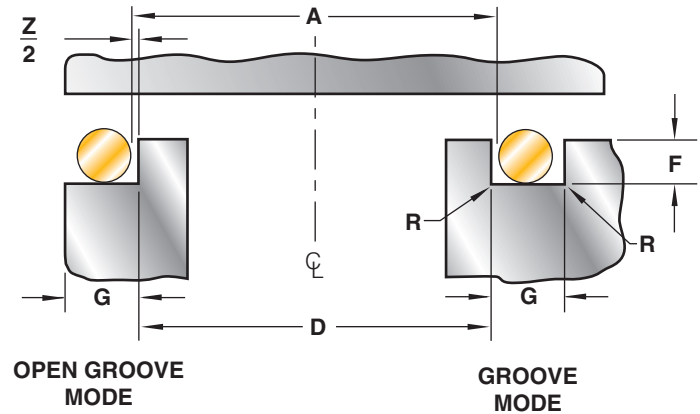

Cavity Dimensions				
Nominal Cross Section	D	F	G	R
	I.D. Range Tolerance h10	Depth Range	Minimum Width	Maximum Radius
1/32	0.180 – 1.000	0.025 – 0.027	0.055	0.010
1/16	0.375 – 8.000	0.045 – 0.050	0.090	0.015
3/32	0.800 – 16.000	0.074 – 0.079	0.150	0.020
1/8	1.250 – 24.000	0.100 – 0.105	0.160	0.030

All dimensions are in inches.  
The tolerance reference table can be found on page E-92.

### ⚠ WARNING

These products can expose you to chemicals including carbon black (airborne and extracts), antimony trioxide, titanium dioxide, silica (crystalline), di(2-ethylhexyl)phthalate, ethylene thiourea, acrylonitrile, 1,3-butadiene, epichlorohydrin, toluene diisocyanate, tetrafluoroethylene, ethylbenzene, formaldehyde, furfuryl alcohol, glass fibers, methyl isobutyl ketone, nickel (metallic and compounds), lead and lead compounds which are known to the state of California to cause cancer; and 1,3-butadiene, epichlorohydrin, di(2-ethylhexyl)phthalate, di-isodecyl phthalate, ethylene thiourea, methyl isobutyl ketone, methanol, toluene, lead and lead compounds which are known to the state of California to cause birth defects and other reproductive harm. For more information go to [www.P65Warnings.ca.gov](http://www.P65Warnings.ca.gov).

**Part Numbering:**

Refer to Section A, page A-9 for part numbering convention. The seal size is specified in the part number as follows:

**EWE - 000000 - 00 - 00 - 0**

Seal I.D. (dimension A) to three decimal places. (Example: A 3.000 inch seal is specified as 003000)

Metal Seal Cross Section Code

Material (Section D)

Temper (Section D)

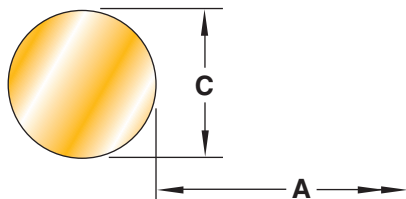

**Seal and Cavity Sizing:**

Seal free height is based on cavity diameter and depth alone. Seal diameter (dimension A) is derived below.

**A = D + Z**

(tolerance ± 0.005)

Where: D = Minimum cavity I.D.

Z = Diametral clearance between cavity and seal

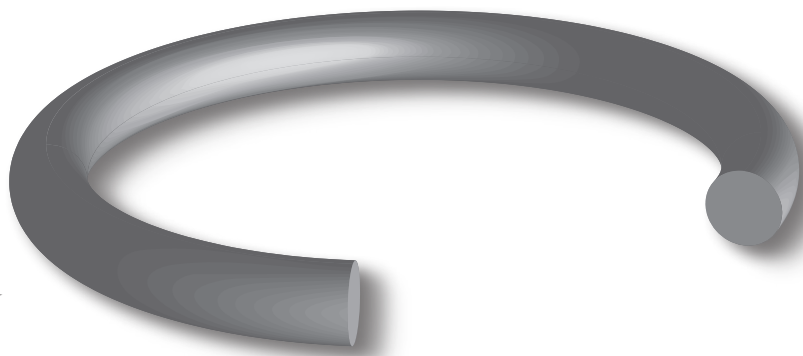

Section C  
Metal Seal Size Selection

Seal Dimensions			
Nominal Cross Section	Z	C	Cross Section Code
	Diametral Clearance	Free Height	
1/32	0.008	0.035 <sup>+0.003</sup> / <sub>-0.001</sub>	03
1/16	0.011	0.062 <sup>+0.003</sup> / <sub>-0.001</sub>	05
3/32	0.013	0.094 <sup>+0.003</sup> / <sub>-0.001</sub>	06
1/8	0.017	0.125 <sup>+0.003</sup> / <sub>-0.001</sub>	07

Performance		
Seating Load (pounds per inch circumference)	Springback (inches)	Working Pressure Rating (psi)
4200	0	20000
6000	0.0005	20000
6000	0.001	20000
6000	0.002	20000

All dimensions are in inches. Performance data is based on annealed 304 Stainless Steel. Seal performance is discussed in Section E.

**WARNING**

These products can expose you to chemicals including carbon black (airborne and extracts), antimony trioxide, titanium dioxide, silica (crystalline), di(2-ethylhexyl)phthalate, ethylene thiourea, acrylonitrile, 1,3-butadiene, epichlorohydrin, toluene diisocyanate, tetrafluoroethylene, ethylbenzene, formaldehyde, furfuryl alcohol, glass fibers, methyl isobutyl ketone, nickel (metallic and compounds), lead and lead compounds which are known to the state of California to cause cancer; and 1,3-butadiene, epichlorohydrin, di(2-ethylhexyl)phthalate, di-isodecyl phthalate, ethylene thiourea, methyl isobutyl ketone, methanol, toluene, lead and lead compounds which are known to the state of California to cause birth defects and other reproductive harm. For more information go to [www.P65Warnings.ca.gov](http://www.P65Warnings.ca.gov).



# ECA Metal C-Ring Axial Seal

### Applications:

- Static and low cycle dynamic axial sealing.
- Fire-safe quarter turn valve stem sealing: up to 30,000 operating cycles.
- 'Plug-in' connector sealing.
- High temperature sealing of mechanical seal to shaft interface.

### Features:

- Close tolerance seal for light installation loads.
- Plating partially transfers to stem for low wear characteristics on quarter turn applications.

INSTALLED VIEW

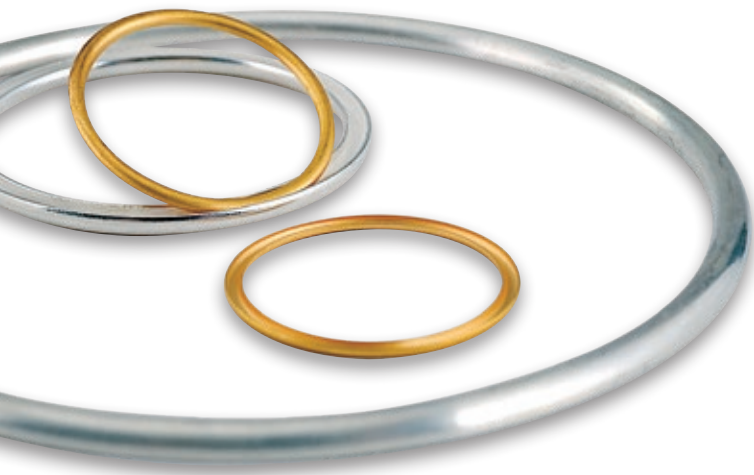
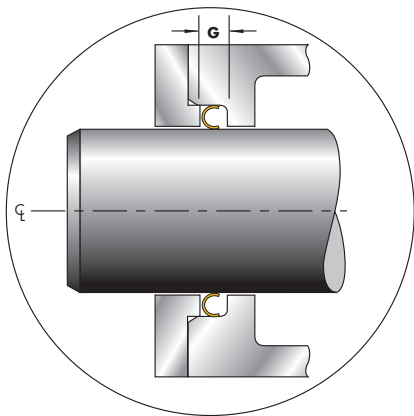

### Cavity Requirements:

- Requires careful control of diametral tolerances and concentricity.

Bore Diameter D	Concentricity ◎
≤ 3.250	0.0005
> 3.250	0.001

- Static mating surfaces should be 8 – 16 μ inch Ra, 60 Rc.
- Dynamic mating surfaces should be 4 – 8 μ inch Ra, 60 Rc.

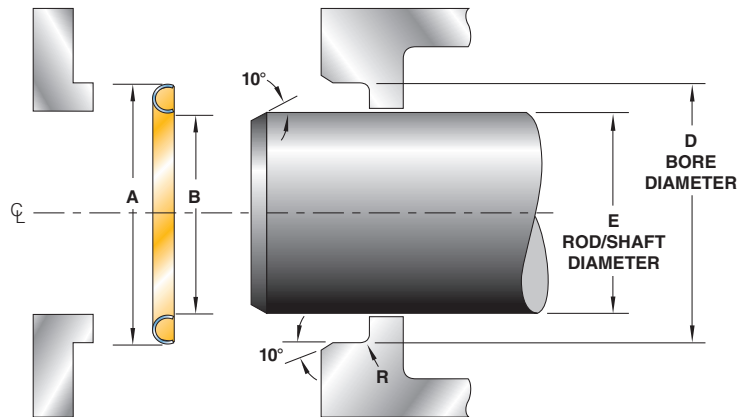

Cavity Dimensions

Nominal Cross Section	D		F	G	R
	Bore Diameter		Rod/Shaft Diameter	Min. Width	Max. Radius
	Range	tol.	tol.		
1/16	0.500–1.500	+0.001 -0.000	D <sub>min</sub> -0.123 +0.001 -0.000	0.051	0.015
	1.501–1.750	+0.001 -0.000	D <sub>min</sub> -0.121 +0.001 -0.000	0.051	0.015
3/32	1.188–1.500	+0.001 -0.000	D <sub>min</sub> -0.185 +0.000 -0.001	0.078	0.020
	1.501–3.250	+0.001 -0.000	D <sub>min</sub> -0.183 +0.000 -0.001	0.078	0.020
1/8	2.000–3.250	+0.001 -0.000	D <sub>min</sub> -0.246 +0.000 -0.001	0.104	0.030
	3.251–6.000	+0.002 -0.000	D <sub>min</sub> -0.242 +0.000 -0.002	0.104	0.030
	6.001–8.000	+0.002 -0.000	D <sub>min</sub> -0.238 +0.000 -0.002	0.104	0.030
5/32	3.250–6.000	+0.002 -0.000	D <sub>min</sub> -0.304 +0.000 -0.002	0.129	0.050
	6.001–10.000	+0.002 -0.000	D <sub>min</sub> -0.300 +0.000 -0.002	0.129	0.050
3/16	4.000–6.000	+0.002 -0.000	D <sub>min</sub> -0.367 +0.000 -0.002	0.156	0.050
	6.001–12.000	+0.002 -0.000	D <sub>min</sub> -0.363 +0.000 -0.002	0.156	0.050
1/4	6.000–12.000	+0.002 -0.000	D <sub>min</sub> -0.488 +0.000 -0.002	0.208	0.060

All dimensions are in inches.

### WARNING

These products can expose you to chemicals including carbon black (airborne and extracts), antimony trioxide, titanium dioxide, silica (crystalline), di(2-ethylhexyl)phthalate, ethylene thiourea, acrylonitrile, 1,3-butadiene, epichlorohydrin, toluene diisocyanate, tetrafluoroethylene, ethylbenzene, formaldehyde, furfuryl alcohol, glass fibers, methyl isobutyl ketone, nickel (metallic and compounds), lead and lead compounds which are known to the state of California to cause cancer; and 1,3-butadiene, epichlorohydrin, di(2-ethylhexyl)phthalate, di-isodecyl phthalate, ethylene thiourea, methyl isobutyl ketone, methanol, toluene, lead and lead compounds which are known to the state of California to cause birth defects and other reproductive harm. For more information go to [www.P65Warnings.ca.gov](http://www.P65Warnings.ca.gov).



**Part Numbering:**

Refer to Section A, page A-9 for part numbering convention. The seal size is specified in the part number as follows:

**ECA - 000000 - 00 - 00 - 0 - XXN**

Seal O.D. prior to plating (dimension A) to three decimal places (Example: A 3.000 inch seal is specified as 003000)

Metal Seal Cross Section Code

Material (Section D)

Temper (Section D)

Standard plating thickness for ECA seal is 0.001 to 0.002 (thickness code N)

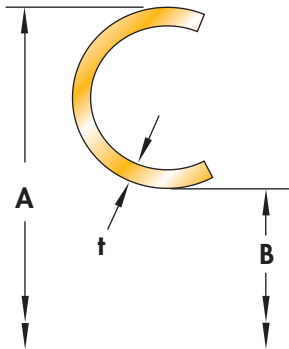

**Seal and Cavity Sizing:**

From Bore Diameter (dim. D) derive the Rod/Shaft Diameter (dim. E) and Seal O.D. (dim. A) using the tables below.



Section C  
Metal Seal Size Selection

Seal Dimensions					Pressure Rating
Nominal Cross Section	A	B	t	Cross Section Code	Working Pressure Rating (psi)
	Seal O.D.	Seal I.D.	Material Thickness		
	tol.	tol.			
1/16	$D_{min}+0.003 \pm 0.001$	$A - 0.129 \pm 0.001$	0.006	05	57,000
	$D_{min}+0.004 \pm 0.001$	$A - 0.129 \pm 0.001$			
3/32	$D_{min}+0.003 \pm 0.001$	$A - 0.191 \pm 0.001$	0.010	07	23,500
	$D_{min}+0.003 \pm 0.001$	$A - 0.191 \pm 0.001$			
1/8	$D_{min}+0.004 \pm 0.001$	$A - 0.254 \pm 0.001$	0.015	09	38,000
	$D_{min}+0.006 \pm 0.002$	$A - 0.254 \pm 0.002$			
	$D_{min}+0.008 \pm 0.002$	$A - 0.254 \pm 0.002$			
5/32	$D_{min}+0.006 \pm 0.002$	$A - 0.316 \pm 0.002$	0.016	11	31,000
	$D_{min}+0.008 \pm 0.002$	$A - 0.316 \pm 0.002$			
3/16	$D_{min}+0.006 \pm 0.002$	$A - 0.379 \pm 0.002$	0.020	13	32,500
	$D_{min}+0.008 \pm 0.002$	$A - 0.379 \pm 0.002$			
1/4	$D_{min}+0.008 \pm 0.002$	$A - 0.504 \pm 0.002$	0.025	15	30,000

All dimensions are in inches and prior to plating.

**WARNING**

These products can expose you to chemicals including carbon black (airborne and extracts), antimony trioxide, titanium dioxide, silica (crystalline), di(2-ethylhexyl)phthalate, ethylene thiourea, acrylonitrile, 1,3-butadiene, epichlorohydrin, toluene diisocyanate, tetrafluoroethylene, ethylbenzene, formaldehyde, furfuryl alcohol, glass fibers, methyl isobutyl ketone, nickel (metallic and compounds), lead and lead compounds which are known to the state of California to cause cancer; and 1,3-butadiene, epichlorohydrin, di(2-ethylhexyl)phthalate, di-isodecyl phthalate, ethylene thiourea, methyl isobutyl ketone, methanol, toluene, lead and lead compounds which are known to the state of California to cause birth defects and other reproductive harm. For more information go to [www.P65Warnings.ca.gov](http://www.P65Warnings.ca.gov).



## Boss Seal for MS-33649 Fluid Connection Boss & MS-33514/33656 Fitting Ends

### Applications:

- Direct replacement/upgrade for elastomeric O-rings on MS-33514 flared and MS-33656 flareless fitting ends, installed into MS-33649 fluid bosses.
- Temperatures to 1200°F.
- System pressures to 5000 psi and above. (Seal is capable of higher pressures. Boss or fitting may be limiting item. Consult your local representative for assistance if pressures exceed 5000 psi).

### Features:

- No rework of boss or fitting is necessary.
- Utilizes proven silver plated alloy X-750 C-ring technology.
- Washer engages with fitting threads for centering the seal in the boss.
- Designed for installation in either direction.
- Internally pressure-energized to maintain sealing stress. No need to retorque.
- Cannot extrude or fail due to ageing, pressure impulses, proof testing or extreme temperatures.
- Fully compatible with all hydraulic fluids and fuels. One seal type works for all fluids.
- Easy selection for all standard dash sizes.

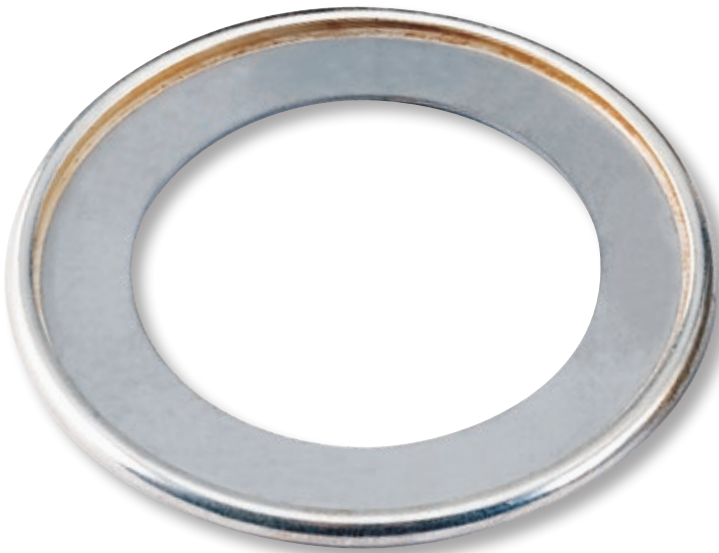
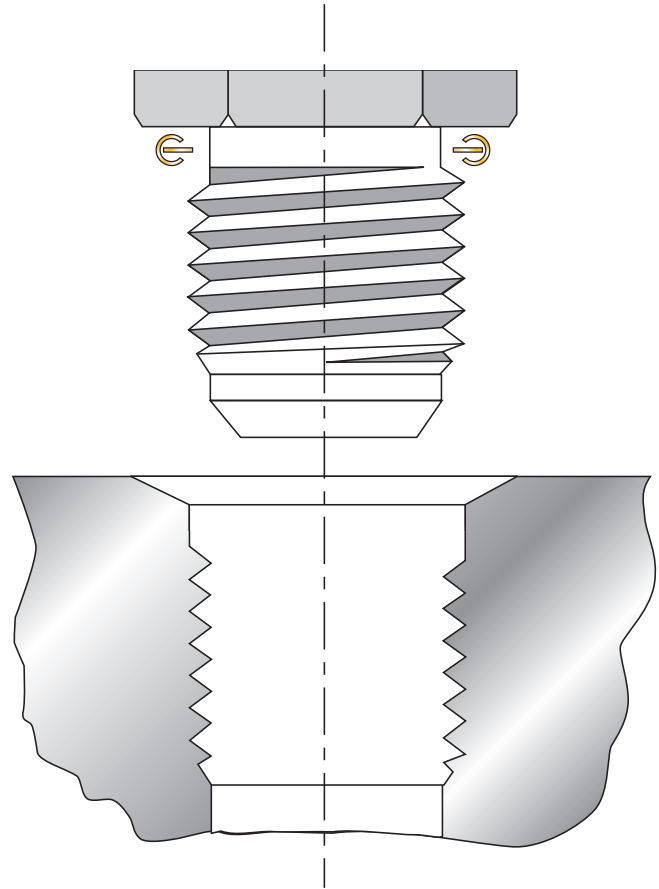

### ⚠ WARNING

These products can expose you to chemicals including carbon black (airborne and extracts), antimony trioxide, titanium dioxide, silica (crystalline), di(2-ethylhexyl)phthalate, ethylene thiourea, acrylonitrile, 1,3-butadiene, epichlorohydrin, toluene diisocyanate, tetrafluoroethylene, ethylbenzene, formaldehyde, furfuryl alcohol, glass fibers, methyl isobutyl ketone, nickel (metallic and compounds), lead and lead compounds which are known to the state of California to cause cancer; and 1,3-butadiene, epichlorohydrin, di(2-ethylhexyl)phthalate, di-isodecyl phthalate, ethylene thiourea, methyl isobutyl ketone, methanol, toluene, lead and lead compounds which are known to the state of California to cause birth defects and other reproductive harm. For more information go to [www.P65Warnings.ca.gov](http://www.P65Warnings.ca.gov).

**Part Number/Ordering:**

Simply refer to the table below to determine the appropriate boss seal part number for the specific MS Dash Number.

The standard boss seal is made from Alloy X-750, work hardened, and silver plated to a thickness of 0.0005 to 0.001 inch.

Other materials are available. Please contact your local representative for assistance.

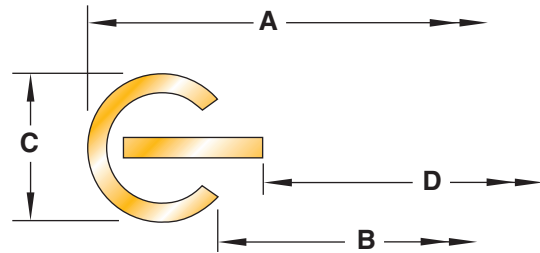

		Seal Dimensions				
MS Dash Number	Boss Seal Part Number	A O.D. (tol. +0.000, - 0.005)	B Seal I.D. (min.)	C Free Height (tol. ± 0.002)	Material Thickness	D Washer I.D. Ref
- 02	66690-02-07-1-SPA	0.381	0.302	0.047	0.006	0.278
- 03	66690-03-07-1-SPA	0.444	0.365	0.047	0.006	0.341
- 04	66690-04-07-1-SPA	0.506	0.427	0.047	0.006	0.397
- 05	66690-05-07-1-SPA	0.569	0.490	0.047	0.006	0.459
- 06	66690-06-07-1-SPA	0.631	0.552	0.047	0.006	0.517
- 07	66690-07-07-1-SPA	0.694	0.615	0.047	0.006	0.579
- 08	66690-08-07-1-SPA	0.819	0.740	0.047	0.006	0.699
- 09	66690-09-07-1-SPA	0.882	0.803	0.047	0.006	0.761
- 10	66690-10-07-1-SPA	0.944	0.865	0.047	0.006	0.817
- 11	66690-11-07-1-SPA	1.100	1.021	0.062	0.006	0.932
- 12	66690-12-07-1-SPA	1.156	1.051	0.062	0.010	0.995
- 14	66690-14-07-1-SPA	1.281	1.176	0.062	0.010	1.120
- 16	66690-16-07-1-SPA	1.406	1.301	0.062	0.010	1.245
- 18	66690-18-07-1-SPA	1.593	1.488	0.062	0.010	1.432
- 20	66690-20-07-1-SPA	1.718	1.613	0.062	0.010	1.557
- 24	66690-24-07-1-SPA	1.968	1.863	0.062	0.010	1.807
- 28	66690-28-07-1-SPA	2.343	2.238	0.062	0.010	2.182
- 32	66690-32-07-1-SPA	2.594	2.489	0.062	0.010	2.432

All dimensions are in inches and prior to plating.

**WARNING**

These products can expose you to chemicals including carbon black (airborne and extracts), antimony trioxide, titanium dioxide, silica (crystalline), di(2-ethylhexyl)phthalate, ethylene thiourea, acrylonitrile, 1,3-butadiene, epichlorohydrin, toluene diisocyanate, tetrafluoroethylene, ethylbenzene, formaldehyde, furfuryl alcohol, glass fibers, methyl isobutyl ketone, nickel (metallic and compounds), lead and lead compounds which are known to the state of California to cause cancer; and 1,3-butadiene, epichlorohydrin, di(2-ethylhexyl)phthalate, di-isodecyl phthalate, ethylene thiourea, methyl isobutyl ketone, methanol, toluene, lead and lead compounds which are known to the state of California to cause birth defects and other reproductive harm. For more information go to [www.P65Warnings.ca.gov](http://www.P65Warnings.ca.gov).



## Metal E-Ring, for AS1895 Flanges

- Specially sized E-rings are listed below to fit all AS1895 (dash number -100 to -750) flanges.
- E-rings are manufactured from unplated Alloy 718, solution annealed and age-hardened in the standard configuration. Other high strength/higher temperature nickel alloys are available including Waspaloy and Rene 41.

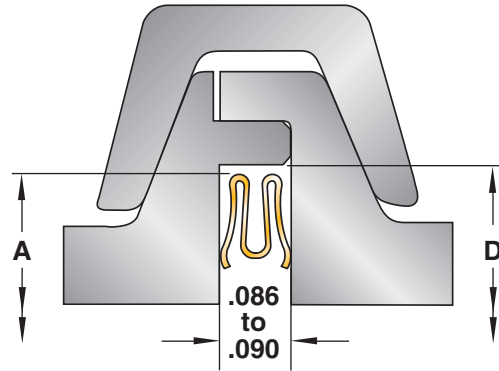

AS1895 Dash Number	D	E-Ring Part Number	A	C
	Cavity (+0.003 -0.000)		Seal O.D. (Tol. H11)	Seal Free Height ±0.005
-100	1.250	69025 -100 - XX	1.247	0.108
-125	1.500	69025 -125 - XX	1.497	0.108
-150	1.750	69025 -150 - XX	1.747	0.108
-175	2.000	69025 -175 - XX	1.997	0.108
-200	2.250	69025 -200 - XX	2.247	0.108
-225	2.500	69025 -225 - XX	2.497	0.108
-250	2.750	69025 -250 - XX	2.747	0.108
-275	3.000	69025 -275 - XX	2.997	0.108
-300	3.250	69025 -300 - XX	3.247	0.108
-325	3.500	69025 -325 - XX	3.497	0.108
-350	3.750	69025 -350 - XX	3.747	0.108
-400	4.250	69025 -400 - XX	4.247	0.108
-450	4.750	69025 -450 - XX	4.747	0.108
-500	5.250	69025 -500 - XX	5.247	0.108
-550	5.750	69025 -550 - XX	5.747	0.108
-600	6.250	69025 -600 - XX	6.247	0.108
-650	6.750	69025 -650 - XX	6.747	0.108
-700	7.250	69025 -700 - XX	7.247	0.108
-750	7.750	69025 -750 - XX	7.747	0.108

All dimensions are in inches.  
The tolerance reference table can be found on page E-92.

**Material Code Choice (XX):**

Material	Material Code
Alloy 718	14
Waspaloy	23
Rene 41	29

**WARNING**

These products can expose you to chemicals including carbon black (airborne and extracts), antimony trioxide, titanium dioxide, silica (crystalline), di(2-ethylhexyl)phthalate, ethylene thiourea, acrylonitrile, 1,3-butadiene, epichlorohydrin, toluene diisocyanate, tetrafluoroethylene, ethylbenzene, formaldehyde, furfuryl alcohol, glass fibers, methyl isobutyl ketone, nickel (metallic and compounds), lead and lead compounds which are known to the state of California to cause cancer; and 1,3-butadiene, epichlorohydrin, di(2-ethylhexyl)phthalate, di-isodecyl phthalate, ethylene thiourea, methyl isobutyl ketone, methanol, toluene, lead and lead compounds which are known to the state of California to cause birth defects and other reproductive harm. For more information go to [www.P65Warnings.ca.gov](http://www.P65Warnings.ca.gov).

# Metal O-Rings for U.S. Aerospace Standards

## AS9141 Parker Part Number EON – Seal diameter code from table below – 01 - 03 - 1

AS Dash Number	Seal Diameter Code	AS Dash Number	Seal Diameter Code	AS Dash Number	Seal Diameter Code	AS Dash Number	Seal Diameter Code
-03	000250	-10	000469	-17	000875	-24	001625
-04	000281	-11	000500	-18	000938	-25	001750
-05	000312	-12	000562	-19	001000	-26	001875
-06	000344	-13	000625	-20	001125	-27	002000
-07	000375	-14	000688	-21	001250		
-08	000406	-15	000750	-22	001375		
-09	000438	-16	000812	-23	001500		

## AS9142 Parker Part Number EON – Seal diameter code from table below – 02 - 03 - 1

AS Dash Number	Seal Diameter Code	AS Dash Number	Seal Diameter Code	AS Dash Number	Seal Diameter Code	AS Dash Number	Seal Diameter Code
-013	000438	-031	001000	-049	001875	-067	003000
-014	000469	-032	001031	-050	001938	-069	003125
-015	000500	-033	001062	-051	002000	-071	003250
-016	000531	-034	001094	-052	002062	-073	003375
-017	000562	-035	001125	-053	002125	-075	003500
-018	000594	-036	001156	-054	002188	-077	003625
-019	000625	-037	001188	-055	002250	-079	003750
-020	000656	-038	001219	-056	002312	-081	003875
-021	000688	-039	001250	-057	002375	-083	004000
-022	000719	-040	001312	-058	002438	-085	004125
-023	000750	-041	001375	-059	002500	-087	004250
-024	000781	-042	001438	-060	002562	-089	004375
-025	000812	-043	001500	-061	002625	-091	004500
-026	000844	-044	001562	-062	002688	-093	004625
-027	000875	-045	001625	-063	002750	-095	004750
-028	000906	-046	001688	-064	002812	-097	004875
-029	000938	-047	001750	-065	002875	-099	005000
-030	000969	-048	001812	-066	002938		

## AS9202 Parker Part Number EON – Seal diameter code from table below – 03 - 03 - 1

AS Dash Number	Seal Diameter Code	AS Dash Number	Seal Diameter Code	AS Dash Number	Seal Diameter Code	AS Dash Number	Seal Diameter Code
-013	000438	-037	001188	-061	002625	-103	005250
-014	000469	-038	001219	-062	002688	-105	005375
-015	000500	-039	001250	-063	002750	-107	005500
-016	000531	-040	001312	-064	002812	-109	005625
-017	000562	-041	001375	-065	002875	-111	005750
-018	000594	-042	001438	-066	002938	-113	005875
-019	000625	-043	001500	-067	003000	-115	006000
-020	000656	-044	001562	-069	003125	-117	006125
-021	000688	-045	001625	-071	003250	-119	006250
-022	000719	-046	001688	-073	003375	-121	006375
-023	000750	-047	001750	-075	003500	-123	006500
-024	000781	-048	001812	-077	003625	-125	006625
-025	000812	-049	001875	-079	003750	-127	006750
-026	000844	-050	001938	-081	003875	-129	006875
-027	000875	-051	002000	-083	004000	-131	007000
-028	000906	-052	002062	-085	004125	-133	007125
-029	000938	-053	002125	-087	004250	-135	007250
-030	000969	-054	002188	-089	004375	-137	007375
-031	001000	-055	002250	-091	004500	-139	007500
-032	001031	-056	002312	-093	004625	-141	007625
-033	001062	-057	002375	-095	004750	-143	007750
-034	001094	-058	002438	-097	004875	-145	007875
-035	001125	-059	002500	-099	005000	-147	008000
-036	001156	-060	002562	-101	005125		

### ⚠ WARNING

These products can expose you to chemicals including carbon black (airborne and extracts), antimony trioxide, titanium dioxide, silica (crystalline), di(2-ethylhexyl)phthalate, ethylene thiourea, acrylonitrile, 1,3-butadiene, epichlorohydrin, toluene diisocyanate, tetrafluoroethylene, ethylbenzene, formaldehyde, furfuryl alcohol, glass fibers, methyl isobutyl ketone, nickel (metallic and compounds), lead and lead compounds which are known to the state of California to cause cancer; and 1,3-butadiene, epichlorohydrin, di(2-ethylhexyl)phthalate, di-isodecyl phthalate, ethylene thiourea, methyl isobutyl ketone, methanol, toluene, lead and lead compounds which are known to the state of California to cause birth defects and other reproductive harm. For more information go to [www.P65Warnings.ca.gov](http://www.P65Warnings.ca.gov).



# Metal O-Rings for U.S. Aerospace Standards

## AS9203 Parker Part Number EON – Seal diameter code from table below – 04 - 03 - 1

AS Dash Number	Seal Diameter Code	AS Dash Number	Seal Diameter Code	AS Dash Number	Seal Diameter Code	AS Dash Number	Seal Diameter Code
-010	001000	-036	002062	-061	003625	-119	007250
-012	001031	-037	002125	-062	003688	-123	007500
-013	001062	-038	002188	-063	003750	-127	007750
-014	001094	-039	002250	-064	003812	-131	008000
-015	001125	-040	002312	-065	003875	-135	008250
-016	001156	-041	002375	-066	003938	-139	008500
-017	001188	-042	002438	-067	004000	-143	008750
-018	001219	-043	002500	-069	004125	-147	009000
-019	001250	-044	002562	-071	004250	-151	009250
-020	001281	-045	002625	-073	004375	-155	009500
-021	001312	-046	002688	-075	004500	-159	009750
-022	001344	-047	002750	-077	004625	-163	010000
-023	001375	-048	002812	-079	004750	-167	010250
-024	001406	-049	002875	-081	004875	-171	010500
-025	001438	-050	002938	-083	005000	-175	010750
-026	001469	-051	003000	-085	005125	-179	011000
-027	001500	-052	003062	-087	005250	-183	011250
-028	001562	-053	003125	-089	005375	-187	011500
-029	001625	-054	003188	-091	005500	-191	011750
-030	001688	-055	003250	-095	005750	-195	012000
-031	001750	-056	003312	-099	006000	-203	012500
-032	001812	-057	003375	-103	006250	-211	013000
-033	001875	-058	003438	-107	006500	-219	013500
-034	001938	-059	003500	-111	006750	-227	014000
-035	002000	-060	003562	-115	007000		

## AS9204 Parker Part Number EON – Seal diameter code from table below – 05 - 03 - 1

AS Dash Number	Seal Diameter Code	AS Dash Number	Seal Diameter Code	AS Dash Number	Seal Diameter Code	AS Dash Number	Seal Diameter Code
-010	001000	-036	002062	-061	003625	-119	007250
-012	001031	-037	002125	-062	003688	-123	007500
-013	001062	-038	002188	-063	003750	-127	007750
-014	001094	-039	002250	-064	003812	-131	008000
-015	001125	-040	002312	-065	003875	-135	008250
-016	001156	-041	002375	-066	003938	-139	008500
-017	001188	-042	002438	-067	004000	-143	008750
-018	001219	-043	002500	-069	004125	-147	009000
-019	001250	-044	002562	-071	004250	-151	009250
-020	001281	-045	002625	-073	004375	-155	009500
-021	001312	-046	002688	-075	004500	-159	009750
-022	001344	-047	002750	-077	004625	-163	010000
-023	001375	-048	002812	-079	004750	-167	010250
-024	001406	-049	002875	-081	004875	-171	010500
-025	001438	-050	002938	-083	005000	-175	010750
-026	001469	-051	003000	-085	005125	-179	011000
-027	001500	-052	003062	-087	005250	-183	011250
-028	001562	-053	003125	-089	005375	-187	011500
-029	001625	-054	003188	-091	005500	-191	011750
-030	001688	-055	003250	-095	005750	-195	012000
-031	001750	-056	003312	-099	006000	-203	012500
-032	001812	-057	003375	-103	006250	-211	013000
-033	001875	-058	003438	-107	006500	-219	013500
-034	001938	-059	003500	-111	006750	-227	014000
-035	002000	-060	003562	-115	007000		

**WARNING**

These products can expose you to chemicals including carbon black (airborne and extracts), antimony trioxide, titanium dioxide, silica (crystalline), di(2-ethylhexyl)phthalate, ethylene thiourea, acrylonitrile, 1,3-butadiene, epichlorohydrin, toluene diisocyanate, tetrafluoroethylene, ethylbenzene, formaldehyde, furfuryl alcohol, glass fibers, methyl isobutyl ketone, nickel (metallic and compounds), lead and lead compounds which are known to the state of California to cause cancer; and 1,3-butadiene, epichlorohydrin, di(2-ethylhexyl)phthalate, di-isodecyl phthalate, ethylene thiourea, methyl isobutyl ketone, methanol, toluene, lead and lead compounds which are known to the state of California to cause birth defects and other reproductive harm. For more information go to [www.P65Warnings.ca.gov](http://www.P65Warnings.ca.gov).

**AS9205**

Parker Part Number **EON** – Seal diameter code from table below – **07 - 03 - 1**

AS Dash Number	Seal Diameter Code	AS Dash Number	Seal Diameter Code	AS Dash Number	Seal Diameter Code	AS Dash Number	Seal Diameter Code
-010	002000	-056	004875	-138	010000	-346	023000
-011	002062	-057	004938	-142	010250	-354	023500
-012	002125	-058	005000	-146	010500	-362	024000
-013	002188	-059	005062	-150	010750	-370	024500
-014	002250	-060	005125	-154	011000	-378	025000
-015	002312	-061	005188	-158	011250	-386	025500
-016	002375	-062	005250	-162	011500	-394	026000
-017	002438	-063	005312	-166	011750	-402	026500
-018	002500	-064	005375	-170	012000	-410	027000
-019	002562	-065	005438	-174	012250	-418	027500
-020	002625	-066	005500	-178	012500	-426	028000
-021	002688	-067	005562	-182	012750	-434	028500
-022	002750	-068	005625	-186	013000	-442	029000
-023	002812	-069	005688	-190	013250	-450	029500
-024	002875	-070	005750	-194	013500	-458	030000
-025	002938	-071	005812	-198	013750	-466	030500
-026	003000	-072	005875	-202	014000	-474	031000
-027	003062	-073	005938	-206	014250	-482	031500
-028	003125	-074	006000	-210	014500	-490	032000
-029	003188	-076	006125	-214	014750	-498	032500
-030	003250	-078	006250	-218	015000	-506	033000
-031	003312	-080	006375	-222	015250	-514	033500
-032	003375	-082	006500	-226	015500	-522	034000
-033	003438	-084	006625	-230	015750	-530	034500
-034	003500	-086	006750	-234	016000	-538	035000
-035	003562	-088	006875	-238	016250	-546	035500
-036	003625	-090	007000	-242	016500	-554	036000
-037	003688	-092	007125	-246	016750	-562	036500
-038	003750	-094	007250	-250	017000	-570	037000
-039	003812	-096	007375	-254	017250	-578	037500
-040	003875	-098	007500	-258	017500	-586	038000
-041	003938	-100	007625	-262	017750	-594	038500
-042	004000	-102	007750	-266	018000	-602	039000
-043	004062	-104	007875	-270	018250	-610	039500
-044	004125	-106	008000	-274	018500	-618	040000
-045	004188	-108	008125	-278	018750	-634	041000
-046	004250	-110	008250	-282	019000	-650	042000
-047	004312	-112	008375	-286	019250	-666	043000
-048	004375	-114	008500	-290	019500	-682	044000
-049	004438	-116	008625	-294	019750	-698	045000
-050	004500	-118	008750	-298	020000	-714	046000
-051	004562	-120	008875	-306	020500	-730	047000
-052	004625	-122	009000	-314	021000	-746	048000
-053	004688	-124	009250	-322	021500	-762	049000
-054	004750	-130	009500	-330	022000	-778	050000
-055	004812	-134	009750	-338	022500		

Section C  
Metal Seal Size Selection

**WARNING**

These products can expose you to chemicals including carbon black (airborne and extracts), antimony trioxide, titanium dioxide, silica (crystalline), di(2-ethylhexyl)phthalate, ethylene thiourea, acrylonitrile, 1,3-butadiene, epichlorohydrin, toluene diisocyanate, tetrafluoroethylene, ethylbenzene, formaldehyde, furfuryl alcohol, glass fibers, methyl isobutyl ketone, nickel (metallic and compounds), lead and lead compounds which are known to the state of California to cause cancer; and 1,3-butadiene, epichlorohydrin, di(2-ethylhexyl)phthalate, di-isodecyl phthalate, ethylene thiourea, methyl isobutyl ketone, methanol, toluene, lead and lead compounds which are known to the state of California to cause birth defects and other reproductive harm. For more information go to [www.P65Warnings.ca.gov](http://www.P65Warnings.ca.gov).



## Metal O-Rings for U.S. Aerospace Standards

### AS9371 Parker Part Number EON – Seal diameter code from table below – 01 - 03 - 1 - SPB

AS Dash Number	Seal Diameter Code	AS Dash Number	Seal Diameter Code	AS Dash Number	Seal Diameter Code	AS Dash Number	Seal Diameter Code
-03	000250	-10	000469	-17	000875	-24	001625
-04	000281	-11	000500	-18	000938	-25	001750
-05	000312	-12	000562	-19	001000	-26	001875
-06	000344	-13	000625	-20	001125	-27	002000
-07	000375	-14	000688	-21	001250		
-08	000406	-15	000750	-22	001375		
-09	000438	-16	000812	-23	001500		

### AS9372 Parker Part Number EON – Seal diameter code from table below – 02 - 03 - 1 - SPB

AS Dash Number	Seal Diameter Code	AS Dash Number	Seal Diameter Code	AS Dash Number	Seal Diameter Code	AS Dash Number	Seal Diameter Code
-013	000438	-031	001000	-049	001875	-067	003000
-014	000469	-032	001031	-050	001938	-069	003125
-015	000500	-033	001062	-051	002000	-071	003250
-016	000531	-034	001094	-052	002062	-073	003375
-017	000562	-035	001125	-053	002125	-075	003500
-018	000594	-036	001156	-054	002188	-077	003625
-019	000625	-037	001188	-055	002250	-079	003750
-020	000656	-038	001219	-056	002312	-081	003875
-021	000688	-039	001250	-057	002375	-083	004000
-022	000719	-040	001312	-058	002438	-085	004125
-023	000750	-041	001375	-059	002500	-087	004250
-024	000781	-042	001438	-060	002562	-089	004375
-025	000812	-043	001500	-061	002625	-091	004500
-026	000844	-044	001562	-062	002688	-093	004625
-027	000875	-045	001625	-063	002750	-095	004750
-028	000906	-046	001688	-064	002812	-097	004875
-029	000938	-047	001750	-065	002875	-099	005000
-030	000969	-048	001812	-066	002938		

### AS9373 Parker Part Number EON – Seal diameter code from table below – 03 - 03 - 1 - SPB

AS Dash Number	Seal Diameter Code	AS Dash Number	Seal Diameter Code	AS Dash Number	Seal Diameter Code	AS Dash Number	Seal Diameter Code
-013	000438	-037	001188	-061	002625	-103	005250
-014	000469	-038	001219	-062	002688	-105	005375
-015	000500	-039	001250	-063	002750	-107	005500
-016	000531	-040	001312	-064	002812	-109	005625
-017	000562	-041	001375	-065	002875	-111	005750
-018	000594	-042	001438	-066	002938	-113	005875
-019	000625	-043	001500	-067	003000	-115	006000
-020	000656	-044	001562	-069	003125	-117	006125
-021	000688	-045	001625	-071	003250	-119	006250
-022	000719	-046	001688	-073	003375	-121	006375
-023	000750	-047	001750	-075	003500	-123	006500
-024	000781	-048	001812	-077	003625	-125	006625
-025	000812	-049	001875	-079	003750	-127	006750
-026	000844	-050	001938	-081	003875	-129	006875
-027	000875	-051	002000	-083	004000	-131	007000
-028	000906	-052	002062	-085	004125	-133	007125
-029	000938	-053	002125	-087	004250	-135	007250
-030	000969	-054	002188	-089	004375	-137	007375
-031	001000	-055	002250	-091	004500	-139	007500
-032	001031	-056	002312	-093	004625	-141	007625
-033	001062	-057	002375	-095	004750	-143	007750
-034	001094	-058	002438	-097	004875	-145	007875
-035	001125	-059	002500	-099	005000	-147	008000
-036	001156	-060	002562	-101	005125		

**WARNING**

These products can expose you to chemicals including carbon black (airborne and extracts), antimony trioxide, titanium dioxide, silica (crystalline), di(2-ethylhexyl)phthalate, ethylene thiourea, acrylonitrile, 1,3-butadiene, epichlorohydrin, toluene diisocyanate, tetrafluoroethylene, ethylbenzene, formaldehyde, furfuryl alcohol, glass fibers, methyl isobutyl ketone, nickel (metallic and compounds), lead and lead compounds which are known to the state of California to cause cancer; and 1,3-butadiene, epichlorohydrin, di(2-ethylhexyl)phthalate, di-isodecyl phthalate, ethylene thiourea, methyl isobutyl ketone, methanol, toluene, lead and lead compounds which are known to the state of California to cause birth defects and other reproductive harm. For more information go to [www.P65Warnings.ca.gov](http://www.P65Warnings.ca.gov).



**AS9374** Parker Part Number **EON** – Seal diameter code from table below – **04 - 03 - 1 - SPB**

AS Dash Number	Seal Diameter Code	AS Dash Number	Seal Diameter Code	AS Dash Number	Seal Diameter Code	AS Dash Number	Seal Diameter Code
-010	001000	-035	002000	-059	003500	-107	006500
-012	001031	-036	002062	-060	003562	-111	006750
-013	001062	-037	002125	-061	003625	-115	007000
-014	001094	-038	002188	-062	003688	-119	007250
-015	001125	-039	002250	-063	003750	-123	007500
-016	001156	-040	002312	-064	003812	-127	007750
-017	001188	-041	002375	-065	003875	-131	008000
-018	001219	-042	002438	-066	003938	-135	008250
-019	001250	-043	002500	-067	004000	-139	008500
-020	001281	-044	002562	-069	004125	-143	008750
-021	001312	-045	002625	-071	004250	-147	009000
-022	001344	-046	002688	-073	004375	-151	009250
-023	001375	-047	002750	-075	004500	-155	009500
-024	001406	-048	002812	-077	004625	-159	009750
-025	001438	-049	002875	-079	004750	-163	010000
-026	001469	-050	002938	-081	004875	-167	010250
-027	001500	-051	003000	-083	005000	-171	010500
-028	001562	-052	003062	-085	005125	-175	010750
-029	001625	-053	003125	-087	005250	-179	011000
-030	001688	-054	003188	-089	005375	-183	011250
-031	001750	-055	003250	-091	005500	-187	011500
-032	001812	-056	003312	-095	005750	-191	011750
-033	001875	-057	003375	-099	006000	-195	012000
-034	001938	-058	003438	-103	006250		

**AS9375** Parker Part Number **EON** – Seal diameter code from table below – **05 - 03 - 1 - SPB**

AS Dash Number	Seal Diameter Code	AS Dash Number	Seal Diameter Code	AS Dash Number	Seal Diameter Code	AS Dash Number	Seal Diameter Code
-010	001000	-035	002000	-059	003500	-107	006500
-012	001031	-036	002062	-060	003562	-111	006750
-013	001062	-037	002125	-061	003625	-115	007000
-014	001094	-038	002188	-062	003688	-119	007250
-015	001125	-039	002250	-063	003750	-123	007500
-016	001156	-040	002312	-064	003812	-127	007750
-017	001188	-041	002375	-065	003875	-131	008000
-018	001219	-042	002438	-066	003938	-135	008250
-019	001250	-043	002500	-067	004000	-139	008500
-020	001281	-044	002562	-069	004125	-143	008750
-021	001312	-045	002625	-071	004250	-147	009000
-022	001344	-046	002688	-073	004375	-151	009250
-023	001375	-047	002750	-075	004500	-155	009500
-024	001406	-048	002812	-077	004625	-159	009750
-025	001438	-049	002875	-079	004750	-163	010000
-026	001469	-050	002938	-081	004875	-167	010250
-027	001500	-051	003000	-083	005000	-171	010500
-028	001562	-052	003062	-085	005125	-175	010750
-029	001625	-053	003125	-087	005250	-179	011000
-030	001688	-054	003188	-089	005375	-183	011250
-031	001750	-055	003250	-091	005500	-187	011500
-032	001812	-056	003312	-095	005750	-191	011750
-033	001875	-057	003375	-099	006000	-195	012000
-034	001938	-058	003438	-103	006250		

**WARNING**

These products can expose you to chemicals including carbon black (airborne and extracts), antimony trioxide, titanium dioxide, silica (crystalline), di(2-ethylhexyl)phthalate, ethylene thiourea, acrylonitrile, 1,3-butadiene, epichlorohydrin, toluene diisocyanate, tetrafluoroethylene, ethylbenzene, formaldehyde, furfuryl alcohol, glass fibers, methyl isobutyl ketone, nickel (metallic and compounds), lead and lead compounds which are known to the state of California to cause cancer; and 1,3-butadiene, epichlorohydrin, di(2-ethylhexyl)phthalate, di-isodecyl phthalate, ethylene thiourea, methyl isobutyl ketone, methanol, toluene, lead and lead compounds which are known to the state of California to cause birth defects and other reproductive harm. For more information go to [www.P65Warnings.ca.gov](http://www.P65Warnings.ca.gov).



## Metal O-Rings for U.S. Aerospace Standards

**AS9376** Parker Part Number **EON** – Seal diameter code from table below – **07 - 03 - 1 - SPB**

AS Dash Number	Seal Diameter Code	AS Dash Number	Seal Diameter Code	AS Dash Number	Seal Diameter Code	AS Dash Number	Seal Diameter Code
-010	002000	-036	003625	-062	005250	-102	007750
-011	002062	-037	003688	-063	005312	-104	007875
-012	002125	-038	003750	-064	005375	-106	008000
-013	002188	-039	003812	-065	005438	-108	008125
-014	002250	-040	003875	-066	005500	-110	008250
-015	002312	-041	003938	-067	005562	-112	008375
-016	002375	-042	004000	-068	005625	-114	008500
-017	002438	-043	004062	-069	005688	-116	008625
-018	002500	-044	004125	-070	005750	-118	008750
-019	002562	-045	004188	-071	005812	-120	008875
-020	002625	-046	004250	-072	005875	-122	009000
-021	002688	-047	004312	-073	005938	-124	009250
-022	002750	-048	004375	-074	006000	-130	009500
-023	002812	-049	004438	-076	006125	-134	009750
-024	002875	-050	004500	-078	006250	-138	010000
-025	002938	-051	004562	-080	006375	-142	010250
-026	003000	-052	004625	-082	006500	-146	010500
-027	003062	-053	004688	-084	006625	-150	010750
-028	003125	-054	004750	-086	006750	-154	011000
-029	003188	-055	004812	-088	006875	-158	011250
-030	003250	-056	004875	-090	007000	-162	011500
-031	003312	-057	004938	-092	007125	-166	011750
-032	003375	-058	005000	-094	007250	-170	012000
-033	003438	-059	005062	-096	007375		
-034	003500	-060	005125	-098	007500		
-035	003562	-061	005188	-100	007625		

**⚠ WARNING**

These products can expose you to chemicals including carbon black (airborne and extracts), antimony trioxide, titanium dioxide, silica (crystalline), di(2-ethylhexyl)phthalate, ethylene thiourea, acrylonitrile, 1,3-butadiene, epichlorohydrin, toluene diisocyanate, tetrafluoroethylene, ethylbenzene, formaldehyde, furfuryl alcohol, glass fibers, methyl isobutyl ketone, nickel (metallic and compounds), lead and lead compounds which are known to the state of California to cause cancer; and 1,3-butadiene, epichlorohydrin, di(2-ethylhexyl)phthalate, di-isodecyl phthalate, ethylene thiourea, methyl isobutyl ketone, methanol, toluene, lead and lead compounds which are known to the state of California to cause birth defects and other reproductive harm. For more information go to [www.P65Warnings.ca.gov](http://www.P65Warnings.ca.gov).

# Section D – Material Selection Process

## Introduction to the Material Selection Process

With the seal type, diameter and cross-section already determined, the following pages (D-52 to D-65) provide specific guidance in selecting the appropriate material(s), temper and finish.

Comprehensive data is given to ensure an optimum match between the many material choices and the application. However, we are always pleased to offer additional technical consulting and advice if required. To obtain the fastest response please send us your completed application data sheet (see page F-103, F-104), for immediate review by our product specialists and engineering staff.

Metal seal material, temper and finish are designated in the part number as shown below.

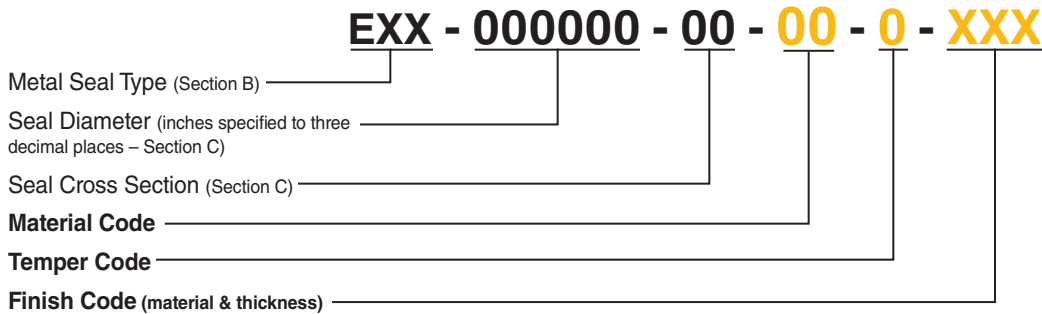

This section includes:	Page
<b>Selecting the Metal Seal Material</b>	
Material Codes for Non-Spring Energized Seals .....	D-52
Material Codes for Spring Energized Seals .....	D-53
Temperature Capabilities – Stainless Steel .....	D-53
Temperature Capabilities – Nickel Alloys .....	D-54
Temperature Capabilities – Cobalt Alloys .....	D-55
Temperature Capabilities – Other Materials .....	D-55
Aerospace Material Specification (AMS) Reference.....	D-56
Yield Strength, Relaxation & Springback.....	D-56
<b>Metal Seal, Platings, Coatings and Finishes</b>	
Temper Codes .....	D-58
Finish Codes .....	D-59
Finish Thickness Selecting Guidelines .....	D-60
Silver-Indium Plating .....	D-61
TriCom® Plating .....	D-62
TriCom-HT™ Plating.....	D-64

**WARNING**

These products can expose you to chemicals including carbon black (airborne and extracts), antimony trioxide, titanium dioxide, silica (crystalline), di(2-ethylhexyl)phthalate, ethylene thiourea, acrylonitrile, 1,3-butadiene, epichlorohydrin, toluene diisocyanate, tetrafluoroethylene, ethylbenzene, formaldehyde, furfuryl alcohol, glass fibers, methyl isobutyl ketone, nickel (metallic and compounds), lead and lead compounds which are known to the state of California to cause cancer; and 1,3-butadiene, epichlorohydrin, di(2-ethylhexyl)phthalate, di-isodecyl phthalate, ethylene thiourea, methyl isobutyl ketone, methanol, toluene, lead and lead compounds which are known to the state of California to cause birth defects and other reproductive harm. For more information go to [www.P65Warnings.ca.gov](http://www.P65Warnings.ca.gov).



## Selecting the Metal Seal Material



The tables below and opposite list all the available materials for non-spring energized seals and spring energized seals.





Starting in the column appropriate to the chosen metal seal type, make the primary material selection by choosing a “preferred,” or possibly “optional” material compatible with the maximum working temperature in the application. Information on temperature resistance is given on the following pages.

Other factors that may also require consideration include ‘NACE’ approval (corrosion resistance) and chemical compatibility. Additional guidance on the effects of material choices on seal performance (load, springback and pressure rating) may be found on pages E-69 to E-77.

Special materials are also available to meet unusually severe operational requirements, or unique procurement specifications. Generally, these will not be stock item materials and may be subject to some additional lead time and material lot charges.

**EXX - 000000 - 00 - 00 - 0 - XXX**

Material Code \_\_\_\_\_

Non-Spring Energized Seals							
Material Code	Material (Common Designation)	NACE Approved (See Note 3)	 C-Ring	 E-Ring	 O-Ring	 U-Ring	 Wire Ring
01	304 Stainless Steel				Preferred <sup>1</sup>		Preferred
02	316 Stainless Steel				Special		Special
03	321 Stainless Steel				Preferred <sup>1</sup>		Special
04	347 Stainless Steel				Special		Special
15	Stainless Steel Alloy A-286		Special				
16	17-4 PH Stainless Steel		Special				
06	Alloy 600				Special		
25	Alloy 625		Special				
14	Alloy 718	Yes	Preferred	Preferred	Optional <sup>2</sup>	Preferred	Special
07	Alloy X-750		Optional	Optional	Optional <sup>2</sup>	Optional	Special
20	Hastelloy C-276	Yes	Special				
23	Waspaloy		Optional	Optional		Optional	
29	Rene 41		Special	Special		Special	
05	Monel 400				Special		Special
30	Haynes 188		Special			Special	
09	Haynes 25		Special		Special		
29	Titanium		Special			Special	
08	Aluminum Alloy 1100						Preferred <sup>4</sup>
12	Copper						Special
13	Nickel						Preferred <sup>4</sup>

1: 321 Stainless Steel is standard for 0.125 inch and smaller free height metal O-rings. 304 Stainless Steel is standard for 0.156 inch and larger free height metal O-rings.



2: Alloy X-750 is optional for 0.250 inch and smaller free height metal O-rings. Alloy 718 is optional for 0.375 inch and larger free height metal O-rings.

3: Approved for use in corrosive seal service per NACE MR-01-075 specification.

4: 3/32 free height wire rings are only available in stainless steel, nickel, and nickel alloys.

**⚠ WARNING**

These products can expose you to chemicals including carbon black (airborne and extracts), antimony trioxide, titanium dioxide, silica (crystalline), di(2-ethylhexyl)phthalate, ethylene thiourea, acrylonitrile, 1,3-butadiene, epichlorohydrin, toluene diisocyanate, tetrafluoroethylene, ethylbenzene, formaldehyde, furfuryl alcohol, glass fibers, methyl isobutyl ketone, nickel (metallic and compounds), lead and lead compounds which are known to the state of California to cause cancer; and 1,3-butadiene, epichlorohydrin, di(2-ethylhexyl)phthalate, di-isodecyl phthalate, ethylene thiourea, methyl isobutyl ketone, methanol, toluene, lead and lead compounds which are known to the state of California to cause birth defects and other reproductive harm. For more information go to [www.P65Warnings.ca.gov](http://www.P65Warnings.ca.gov).

Spring Energized Seals				
Material Code	Jacket/Spring Material Combination (Common Designation) Jacket/Spring	NACE Metal C-Ring Approved (See Note 3 on previous page)	Spring Energized Metal C-Ring 	Spring Energized Metal O-Ring 
01	304 Stainless Steel / 304 Stainless Steel		Optional	<b>Preferred</b>
02	304 Stainless Steel / Cobalt Chromium-Nickel Alloy		Special	
03	Alloy X-750 / Cobalt Chromium-Nickel Alloy		Special	
04	Aluminum Al 1100-0 / 304 Stainless Steel		Special	
05	Alloy X-750 / 304 Stainless Steel		Special	
06	Alloy X-750 / Alloy X-750		<b>Preferred</b>	Special
07	304 Stainless Steel / Alloy X-750		Optional	
08	304 Stainless Steel / Nimonic 90		Special	
09	Alloy X-750 / Nimonic 90		Special	
10	Alloy X-750 / Alloy 718		Optional	
11	Alloy 718 / Alloy 718	Yes	Optional	
12	Alloy 718 / Alloy X-750	Yes	Optional	
13	Nickel / Alloy X-750		Special	
14	Alloy 718 / Cobalt Chromium-Nickel Alloy		Special	
15	Cobalt Chromium-Nickel Alloy / Cobalt Chromium-Nickel Alloy		Special	
16	Alloy C-276 / Alloy C-276		Special	
17	Alloy 625 / Alloy 625		Special	

Other materials are available upon special request. Please contact one of our applications engineers for assistance.

Temperature Capability								
Stainless Steel								
Material	UNS No.	AMS Specifications				Description	Maximum Recommended Service Temperature	Typical Usage
		Strip & Sheet	Tubing	Wire				
Wire Rings	Spring							
304/304L	S30400	AMS 5511, AMS 5513	AMS 5560, AMS 5565	AMS 5697	AMS 5857	The most commonly used stainless steel alloy. Excellent formability and good corrosion resistance. Found in a wide variety of commercial, industrial and consumer applications.	600°F (316°C)	C-rings, O-rings and wire rings in cryogenic to moderate temperature applications requiring mild corrosion resistance.
316/316L	S31600		AMS 5597	AMS 5690		The addition of molybdenum offers improved corrosion resistance when compared to 304/304L. These alloys also offer enhanced creep, stress-to-rupture, and tensile strengths at elevated temperatures.	600°F (316°C)	
17-4PH	S17400	AMS 5604				A chromium-nickel-copper, precipitation hardenable martensitic stainless steel used for applications requiring high strength and a moderate level of corrosion resistance.	600°F (316°C)	
321	S32100		AMS 5570, AMS 5576	AMS 5689		Stabilized by the addition of titanium, this alloy provides excellent resistance to intergranular corrosion following prolonged exposure to elevated service temperatures.	800°F (427°C)	
347	S34700			AMS 5674		Stabilized by the addition of columbium and tantalum. Offers increased resistance to sensitization compared to alloy 321.	800°F (427°C)	
Alloy 286	S66286	AMS 5525				Designed for applications requiring high strength with good corrosion and oxidation resistance at moderately high temperatures. This precipitation-hardenable alloy provides a high degree of uniformity in developing maximum strength, which can be duplicated application after application.	1200°F (649°C)	

**WARNING**

These products can expose you to chemicals including carbon black (airborne and extracts), antimony trioxide, titanium dioxide, silica (crystalline), di(2-ethylhexyl)phthalate, ethylene thiourea, acrylonitrile, 1,3-butadiene, epichlorohydrin, toluene diisocyanate, tetrafluoroethylene, ethylbenzene, formaldehyde, furfuryl alcohol, glass fibers, methyl isobutyl ketone, nickel (metallic and compounds), lead and lead compounds which are known to the state of California to cause cancer; and 1,3-butadiene, epichlorohydrin, di(2-ethylhexyl)phthalate, di-isodecyl phthalate, ethylene thiourea, methyl isobutyl ketone, methanol, toluene, lead and lead compounds which are known to the state of California to cause birth defects and other reproductive harm. For more information go to [www.P65Warnings.ca.gov](http://www.P65Warnings.ca.gov).



## Selecting the Metal Seal Material

Temperature Capability								
Nickel Alloys								
Material	UNS No.	AMS Specifications				Description	Maximum Recommended Service Temperature	Typical Usage
		Strip & Sheet	Tubing	Wire				
				Wire Rings	Spring			
Monel® 400	N04400		AMS 4574	AMS 4730		A ductile nickel-copper solid-solutioned-strengthened alloy with good general corrosion resistance in a wide range of media. Slightly magnetic at room temperature.	600°F (316°C)	C-ring applications requiring corrosion resistance to specific environments.
Alloy 276	N10276	AMS 5530				A nickel-molybdenum-chromium alloy offering superior corrosion resistance. Excellent resistance to pitting and stress corrosion cracking. Suitable for a wide variety of chemical processing environments.	1000°F (538°C)	C-ring applications requiring the utmost in corrosion protection.
Alloy 600	N07600		AMS 5580			A nickel-chromium alloy with good oxidation resistance at moderate service temperatures. Good resistance to carburizing and chloride containing environments.	1000°F (538 °C)	C-ring applications requiring corrosion resistance to specific environments.
Alloy 625	N07625	AMS 5599				A solid-solution-strengthened, nickel-chromium-molybdenum alloy with good high-temperature strength. Offers good oxidation resistance and excellent corrosion resistance.	1000 °F (538°C)	
Nimonic® 90	N07090				AMS 5829	A nickel-chromium-cobalt alloy being precipitation hardenable, having high stress-rupture strength and creep resistance at high temperatures	1000°F (538°C)	Spring material for spring-energized C-rings.
Alloy X750	N07750	AMS 5598	AMS 5582		AMS 5699	An age-hardenable nickel-based superalloy with good high-temperature strength. Readily cold-formed using standard forming techniques.	1100°F (593°C)	These materials are useful for all seal types up to their maximum service temperature. Particularly suitable for gas turbine and aerospace applications with large thermal and mechanical transients.
Alloy 718	N07718	AMS 5596	AMS 5590			An age-hardenable nickel superalloy with excellent high-temperature strength and good oxidation resistance. Excellent cold-forming characteristics. Higher strength than Alloy X750 with improved weldability.	1200°F (649°C)	
Waspaloy	N07701	AMS 5544				An age-hardenable nickel-based superalloy with very good high-temperature strength and oxidation resistance at service temperatures up to 1350°F (732°C). Strength is superior to Alloy 718 above 1150°F.	1350°F (732°C)	
Rene 41	N07041	AMS 5545				An age-hardenable nickel-based superalloy with superior strength up to 1450°F (788°C).	1450°F (788°C)	
Haynes® 230	N06230	AMS 5878				A solid-solutioned-strengthened, nickel-chromium-tungsten-molybdenum alloy with good high-temperature strength and excellent oxidation resistance. Excellent thermal stability and resistance to nitriding environments.	1600°F (871°C)	
Haynes® 214	N/A (DIN 17744-2.4646)					A nickel-chromium-aluminum-iron alloy with superior high-temperature oxidation resistance and very good high-temperature strength. Highly resistant to carburizing and nitriding environments.	1800°F (982°C)	Not as strong as the age-hardenable nickel alloys, these materials are useful where long term oxidation resistance is a prime concern.

**⚠ WARNING**

These products can expose you to chemicals including carbon black (airborne and extracts), antimony trioxide, titanium dioxide, silica (crystalline), di(2-ethylhexyl)phthalate, ethylene thiourea, acrylonitrile, 1,3-butadiene, epichlorohydrin, toluene diisocyanate, tetrafluoroethylene, ethylbenzene, formaldehyde, furfuryl alcohol, glass fibers, methyl isobutyl ketone, nickel (metallic and compounds), lead and lead compounds which are known to the state of California to cause cancer; and 1,3-butadiene, epichlorohydrin, di(2-ethylhexyl)phthalate, di-isodecyl phthalate, ethylene thiourea, methyl isobutyl ketone, methanol, toluene, lead and lead compounds which are known to the state of California to cause birth defects and other reproductive harm. For more information go to [www.P65Warnings.ca.gov](http://www.P65Warnings.ca.gov).

Temperature Capability [cont.]								
Cobalt Alloys								
Material	UNS No.	AMS Specifications				Description	Maximum Recommended Service Temperature	Typical Usage
		Strip & Sheet	Tubing	Wire				
				Wire Rings	Spring			
Elgiloy® Cobalt-Chromium-Nickel Alloy	R30003	AMS 5876			AMS 5833	This cobalt-chromium-nickel alloy gives a combination of high strength, ductility and good mechanical properties and is age hardenable. Excellent fatigue life and corrosion resistance in numerous environments.	700°F (371°C)	Approved high strength spring material for sour gas application.
Haynes® 25	R30605	AMS 5537				A solid-solution-strengthened, cobalt-nickel-chromium-tungsten alloy with very good resistance to high-temperature oxidizing environments. Largely replaced by Haynes 188 and Haynes 230.	1600°F (871°C)	High temperature C-ring applications. High wear C-ring applications.
Haynes® 188	R30188	AMS 5608				A cobalt-nickel-chromium-tungsten alloy with very good resistance to high-temperature oxidizing environments. Better thermal stability than Haynes 25 with similar high-temperature strength.	1600°F (871°C)	High temperature C-ring applications.

Temperature Capabilities								
Other Materials								
Material	UNS No.	AMS Specifications				Description	Maximum Recommended Service Temperature	Typical Usage
		Strip & Sheet	Tubing	Wire				
				Wire Rings	Spring			
Indium	N/A					Commercially pure (> 99.9%) Indium	150°F (66°C)	Electroplated in various combinations to provide a ductile outer layer that enhances seal-ability and/or corrosion. Occasionally used for wire rings.
Lead	N/A					Commercially pure (> 99.9%) Lead	400°F (204°C)	
Teflon®	N/A					Chemically inert polymer. Highly resistant to chemical attack.	500°F (260°C)	Near net-shape electroplated anti-wear coatings. Used to prolong seal life in applications with high thermal, mechanical or vibrational movement.
Copper	C11000					Commercially pure (> 99.0% copper). Fair corrosion resistance.	600°F (316°C)	Electroplated in various combinations to provide a ductile outer layer that enhances seal-ability and/or corrosion. Occasionally used for wire rings.
Nickel 200	N02200					Commercially pure (> 99.9%) Nickel	600°F (316°C)	Low-temperature wire rings.
Aluminum Alloy 1100	A91100					Commercially pure (> 99.0%) aluminum. Good corrosion resistance and high formability.	1000°F (538°C)	Machined seals.
Silver	N/A					Commercially pure (> 99.9%) Silver	1200°F (650°C) Oxidizing 800°F (425°C) nonoxidizing	Electroplated in various combinations to provide a ductile outer layer that enhances seal-ability and/or corrosion. Occasionally used for wire rings.
TriCom®	N/A					A cobalt-chrome-carbide anti-wear coating with a low coefficient of friction and good oxidation resistance.	1200°F (649°C)	Near net-shape electroplated anti-wear coatings. Used to prolong seal life in applications with high thermal, mechanical or vibrational movement.
Nickel 201	N02201					Low-carbon version of Nickel 200. Preferable for application temperatures above 600°F (316°C).	1400°F (760°C)	High-temperature wire rings.
Gold	N/A					Commercially pure (> 99.9%) Gold	1700°F (927°C)	Electroplated in various combinations to provide a ductile outer layer that enhances seal-ability and/or corrosion. Occasionally used for wire rings.
Tribaloy® T-400	N/A					Cobalt-chromium-molybdenum alloys offering excellent wear resistance at extreme temperatures.	1800°F (982°C)	HVOF plasma-sprayed anti-wear coatings for extreme environments. May require post-coating machining to meet design tolerances.
Tribaloy® T-800	N/A						1800°F (982°C)	
Nickel	N/A					Commercially pure (> 99.9%) Nickel	2200°F (1204°C)	Electroplated in various combinations to provide a ductile outer layer that enhances seal-ability and/or corrosion. Occasionally used for wire rings.

**WARNING**  
 These products can expose you to chemicals including carbon black (airborne and extracts), antimony trioxide, titanium dioxide, silica (crystalline), di(2-ethylhexyl)phthalate, ethylene thiourea, acrylonitrile, 1,3-butadiene, epichlorohydrin, toluene diisocyanate, tetrafluoroethylene, ethylbenzene, formaldehyde, furfuryl alcohol, glass fibers, methyl isobutyl ketone, nickel (metallic and compounds), lead and lead compounds which are known to the state of California to cause cancer; and 1,3-butadiene, epichlorohydrin, di(2-ethylhexyl)phthalate, di-isodecyl phthalate, ethylene thiourea, methyl isobutyl ketone, methanol, toluene, lead and lead compounds which are known to the state of California to cause birth defects and other reproductive harm. For more information go to [www.P65Warnings.ca.gov](http://www.P65Warnings.ca.gov).



## Aerospace Material Specification (AMS) Reference

Our material procurement specifications ensure that we receive only the highest quality materials in a condition best suited for seal manufacture. This ensures that you receive the highest quality seals with consistent performance. Our procurement specifications comply with (but are frequently more stringent than) the following AMS specifications.

Material (Common Designation)	Strip & Sheet	Tubing	Wire	
	C-Rings, E-Rings, U-Rings	O-Rings	Wire Rings	Springs
304 Stainless Steel	AMS 5511	AMS 5560, 5565	AMS 5697	AMS 5857
316 Stainless Steel		AMS 5584	AMS 5690	
17-4 PH Stainless Steel				
Monel 400		AMS 4574	AMS 4730	
Cobalt Chromium-Nickel Alloy	AMS 6876			AMS 5833
321 Stainless Steel		AMS 5570, 5576	AMS 5689	
347 Stainless Steel		AMS 5575	AMS 5674	
Alloy 600		AMS 5580		
Alloy 625	AMS 5599			
Aluminum Al 1100-0	AMS 4001			
Hastelloy C-276	AMS 5530			
Alloy X-750	AMS 5598	AMS 5582		AMS 5699
Alloy 718	AMS 5596	AMS 5590		
Stainless Steel Alloy A-286	AMS 5525			
Waspaloy	AMS 5544			
Rene 41	AMS 5545			
Haynes 188	AMS 5608			

## Yield Strength, Relaxation & Springback

Yield strength and stress relaxation are particularly important in the design and application of resilient metal seals for elevated temperatures. For any given seal design, springback is a function of yield strength and stress relaxation (as well as modulus of elasticity).

A useful estimation of springback for short term exposure to elevated temperatures may be obtained by derating the published springback by the ratio of the yield strength at the elevated temperature to the yield strength at ambient temperature.

$$SB_A = \frac{YS_T}{YS_{RT}} SB_o$$

Where:  $SB_A$  = Springback adjusted

$YS_T$  = Yield Strength at elevated temperature

$YS_{RT}$  = Yield Strength at room temperature

$SB_o$  = Original Springback

Stress relaxation occurs when material is exposed to long term elevated temperatures. This results in reduced load and springback.

### ⚠ WARNING

These products can expose you to chemicals including carbon black (airborne and extracts), antimony trioxide, titanium dioxide, silica (crystalline), di(2-ethylhexyl)phthalate, ethylene thiourea, acrylonitrile, 1,3-butadiene, epichlorohydrin, toluene diisocyanate, tetrafluoroethylene, ethylbenzene, formaldehyde, furfuryl alcohol, glass fibers, methyl isobutyl ketone, nickel (metallic and compounds), lead and lead compounds which are known to the state of California to cause cancer; and 1,3-butadiene, epichlorohydrin, di(2-ethylhexyl)phthalate, di-isodecyl phthalate, ethylene thiourea, methyl isobutyl ketone, methanol, toluene, lead and lead compounds which are known to the state of California to cause birth defects and other reproductive harm. For more information go to [www.P65Warnings.ca.gov](http://www.P65Warnings.ca.gov).



Temperature Capability – Yield Strength								
Temperature Deg. F	Alloy 718 HT'd per AMS 5596 ksi	Alloy X750 HT'd per AMS 5598 ksi	Waspaloy HT'd per AMS 5544 ksi	Rene 41 Yield ksi	Haynes 188 Yield ksi	Haynes 214 Yield ksi	Haynes 230 Yield ksi	Haynes 25 Yield ksi
70	178.4	141.1	131.8	119.0	67.3	87.6	56.9	69.0
1000	144.0	124.9	125.2	115.0	42	78.9	39.7	48.0
1100	144.4	123.1	118.6	113.0	40.9	80	39.4	48.0
1200	144.8	121.2	112.0	111.0	39.7	81.1	39.0	48.0
1400	108.6	92.0	111.8	109.0	38.9	78.8	41.2	41.0
1500	69.6	67.6	85.9	96.5	37.4	61.9	36.8	38.5
1600	30.6	43.1	60.0	84.0	35.9	45	32.4	36.0
1700	21.8	26.1	39.8	62.0	27.5	26.4	25.9	27.0
1800	13.0	9.1	19.6	40.0	19.0	7.8	17.3	18.0

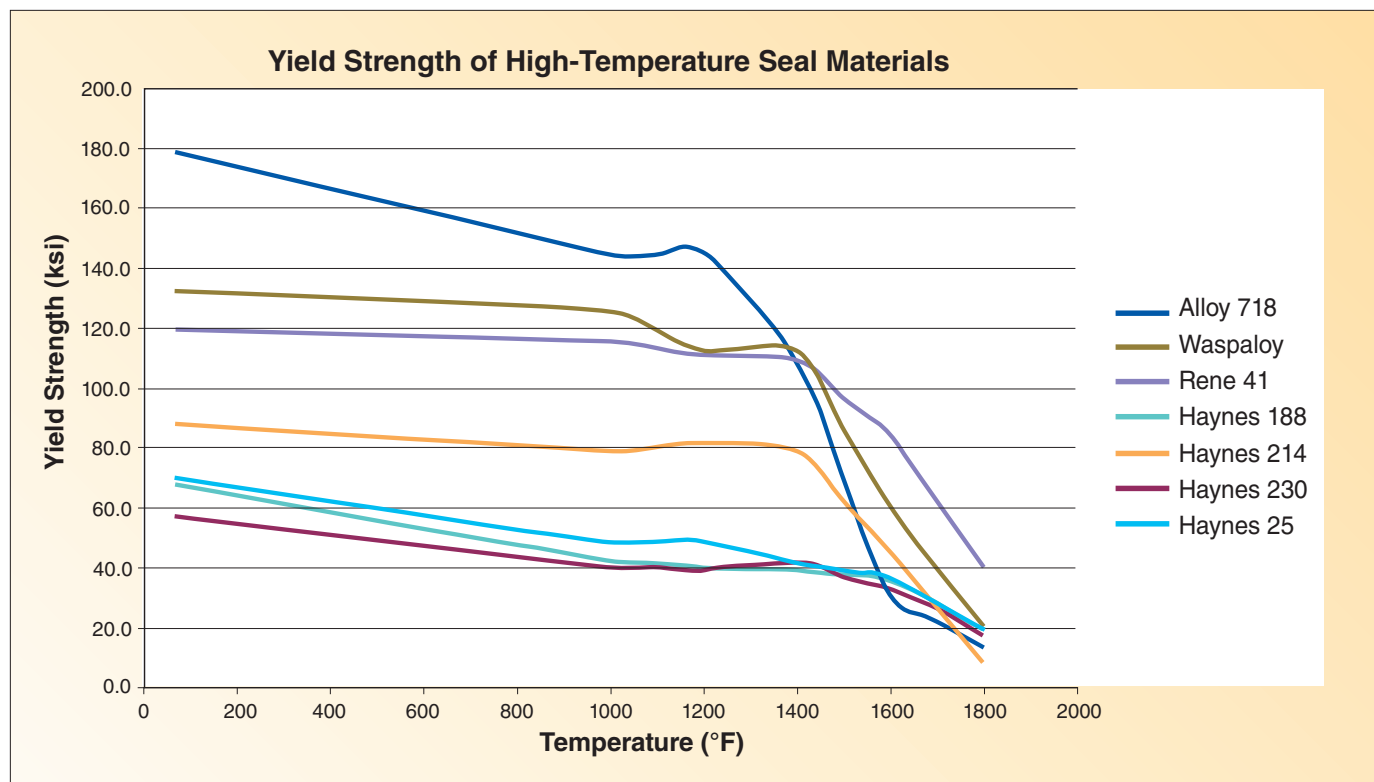

**WARNING**

These products can expose you to chemicals including carbon black (airborne and extracts), antimony trioxide, titanium dioxide, silica (crystalline), di(2-ethylhexyl)phthalate, ethylene thiourea, acrylonitrile, 1,3-butadiene, epichlorohydrin, toluene diisocyanate, tetrafluoroethylene, ethylbenzene, formaldehyde, furfuryl alcohol, glass fibers, methyl isobutyl ketone, nickel (metallic and compounds), lead and lead compounds which are known to the state of California to cause cancer; and 1,3-butadiene, epichlorohydrin, di(2-ethylhexyl)phthalate, di-isodecyl phthalate, ethylene thiourea, methyl isobutyl ketone, methanol, toluene, lead and lead compounds which are known to the state of California to cause birth defects and other reproductive harm. For more information go to [www.P65Warnings.ca.gov](http://www.P65Warnings.ca.gov).



# Metal Seal Material Temper







We provide clear recommendations on the best choice of material condition for the type of seal selected and material type. For high performance resilient metal seals manufactured from nickel alloys such as X-750, 718 and Waspaloy, we recommend a solution annealed and age hardened heat treatment to our standard (-6) condition after forming. This increases springback and load by increasing yield strength, as well as improving fatigue resistance and creep resistance. Metal O-Rings and Spring Energized C-Rings are frequently manufactured from austenitic stainless steels which are not precipitation hardenable. These seals are supplied in the work hardened condition.

EXX - 000000 - 00 - 00 - 0 - XXX

Temper Code \_\_\_\_\_

Temper Code	Temper Description
1	Work Hardened
2	Age Hardened
4	Annealed
6	Solution Heat Treat, (Stabilization Heat Treat if applicable), and Precipitation Heat Treat
8	Temper For Service Per NACE MR-01-075 Specification

## Temper Codes for Non-Spring Energized Seals

Material Code	Material (Common Designation)	 C-Ring (Face Seal)	 Axial C-Ring	 E-Ring	 O-Ring	 U-Ring	 Wire Ring
01	304 Stainless Steel				1		4
02	316 Stainless Steel				1		4
03	321 Stainless Steel				1		4
04	347 Stainless Steel				1		4
05	Monel 400				1		4
06	Alloy 600				1		
07	Alloy X-750	6	1		1 <sup>†</sup>		
08	Aluminum Alloy 1100						4
09	Haynes 25				1		
10	Gold						4
11	Silver						4
12	Copper						4
13	Nickel						4
14	Alloy 718	6*	1 or 6*	6*	1 <sup>†</sup>	6*	
15	Stainless Steel Alloy A-286	6	1				
16	17-4 PH Stainless Steel	6	1				
20	Hastelloy C-276	1	1				
23	Waspaloy	6	6	6		6	
25	Alloy 625	6	1				
29	Rene 41	6	6	6		6	
29	Titanium	1	1			1	
30	Haynes 188	1	1			1	

\*NACE APPROVAL – For approval in corrosive service per NACE MR-01-075 Specification, specify temper code 8.  
<sup>†</sup>Alloy X-750 and 718 O-Rings are available in -6 and -2 tempers for increased fatigue and stress relaxation resistance and seating load.

## Temper Codes for Spring Energized Seals

The -1 Work Hardened temper code is standard for all Spring Energized Seals. All springs are supplied in an appropriate spring temper prior to installation in the seal jacket. The -6 Solution Annealed and Age Hardened temper code is available for increased fatigue resistance of the jacket/spring combinations (at right) in cyclic operating conditions such as piston engines.

Material Code	Jacket/Spring Materials
06	Alloy X-750/Alloy X-750
11	Alloy 718/Alloy 718

**WARNING**

These products can expose you to chemicals including carbon black (airborne and extracts), antimony trioxide, titanium dioxide, silica (crystalline), di(2-ethylhexyl)phthalate, ethylene thiourea, acrylonitrile, 1,3-butadiene, epichlorohydrin, toluene diisocyanate, tetrafluoroethylene, ethylbenzene, formaldehyde, furfuryl alcohol, glass fibers, methyl isobutyl ketone, nickel (metallic and compounds), lead and lead compounds which are known to the state of California to cause cancer; and 1,3-butadiene, epichlorohydrin, di(2-ethylhexyl)phthalate, di-isodecyl phthalate, ethylene thiourea, methyl isobutyl ketone, methanol, toluene, lead and lead compounds which are known to the state of California to cause birth defects and other reproductive harm. For more information go to [www.P65Warnings.ca.gov](http://www.P65Warnings.ca.gov).

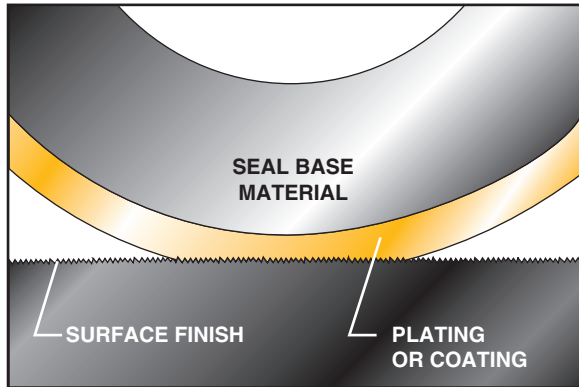

EXX - 000000 - 00 - 00 - 0 - XXX

Finish Code \_\_\_\_\_  
 Finish Thickness \_\_\_\_\_

Specialized platings and coatings allow us to modify the surface properties of a metal seal to create a ductile, low hardness outer surface layer. This acts as an integral “gasket” and ensures optimum sealing despite mating surface imperfections. However, unlike a large surface area traditional flat gasket, the narrow footprint of a metal seal produces a high localized contact stress without excessive bolt-up loads.

Platings and coatings can also improve seal performance by reducing the coefficient of friction of the seal and preventing galling. This assists the seal to slide and “seat down” properly during initial compression or permit, for example, limited dynamic use as a valve stem seal.

In addition to the primary physical properties of ductility and softness, seal coatings are also chosen to withstand high temperatures and often corrosive or oxidizing environments. With a wide choice of surface coatings available, we recommend the selection be made by the following process of elimination.

1. Eliminate all platings and coatings with inadequate high temperature capability (see table below).
2. Eliminate all coatings chemically incompatible with the fluid medium.
3. Choose the softest remaining coating able to withstand the seating stresses. (Ultra soft materials such as Indium and Lead are very easily damaged and subject to creep if overstressed. They should only be selected for specially critical applications with well controlled handling and installation instructions.)
4. NOTE: Silver remains, for many applications, the preferred choice.

Finish Code	Finish Material	Properties, Uses And Limitations	Maximum Temp °F	Maximum Seal Load Lb/In
	Unplated	Typically air applications where total leak tightness is not required. Lowest cost. Contact your local representative for anti-gall coating options.	depends on base	not limited
SFX (unplated) SSX (Silver) SGX (Gold) etc.	Super-Finishing	Spin-polished substrate sealing surfaces with a circular lay. Improves leakage control on unplated or low load seals, or for high vacuum.	depends on base & plating	depends on plating
IP	Indium (In)	Extremely soft metal, excellent for cryogenics, low strength flanges, optical components and vacuum. Not for use with high load seals or at high pressures, due to creep and extrusion.	150	350
LP	Lead (Pb)	Similar properties to Indium, although slightly harder and higher temperature capability. Not for use with high load seals.	400	400
PC	Tin (Sn)	Very soft metal, excellent for cryogenics, low strength flanges, optical components and vacuum. Not for use with high load seals or at high pressures, due to creep and extrusion.	400	400
TC	Teflon (PTFE)	Chemically inert soft polymer. Not for use with high load seals. Permits some permeation of gases.	450	450
SP	Silver (Ag)	Closest to an ideal plating material and therefore most frequently selected for a wide variety of applications. Soft in its pure and annealed form. Good corrosion and temperature resistance. Used in nuclear seals/borated water. Excellent anti-galling properties. Inexpensive.	500 (oxidizing) 1200 (non-oxidizing)	not limited
AP	Gold under Silver	Oxidizing environments above 500°F. As high temperature oxygen permeates the outer silver layer the thin gold layer ensures proper adhesion of the silver.	1200	not limited
GP	Gold (Au)	Soft metal with excellent chemical and oxidation resistance and very high temperature capability. Expensive for larger sizes.	1700	not limited
CP	Copper (Cu)	Relatively soft and inexpensive plating. Good high temperature resistance. Not for use with Waspaloy.	1700	not limited
NP	Nickel (Ni)	Very high temperature capability, but harder than either Silver or Copper even when annealed. Used instead of silver in hot, oxidizing environments.	2200	not limited

**WARNING**  
 These products can expose you to chemicals including carbon black (airborne and extracts), antimony trioxide, titanium dioxide, silica (crystalline), di(2-ethylhexyl)phthalate, ethylene thiourea, acrylonitrile, 1,3-butadiene, epichlorohydrin, toluene diisocyanate, tetrafluoroethylene, ethylbenzene, formaldehyde, furfuryl alcohol, glass fibers, methyl isobutyl ketone, nickel (metallic and compounds), lead and lead compounds which are known to the state of California to cause cancer; and 1,3-butadiene, epichlorohydrin, di(2-ethylhexyl)phthalate, di-isodecyl phthalate, ethylene thiourea, methyl isobutyl ketone, methanol, toluene, lead and lead compounds which are known to the state of California to cause birth defects and other reproductive harm. For more information go to [www.P65Warnings.ca.gov](http://www.P65Warnings.ca.gov).



## Finish Thickness Selection Guidelines

Finish of the mating surfaces is an important factor in selecting the most appropriate plating or coating thickness. Generally, rougher surfaces require thicker finishes to ensure proper sealing. Refer to the appropriate seal cross section in the bar chart below. Locate the flange surface finish in the bar above the seal free height to determine the appropriate finish thickness on the left.

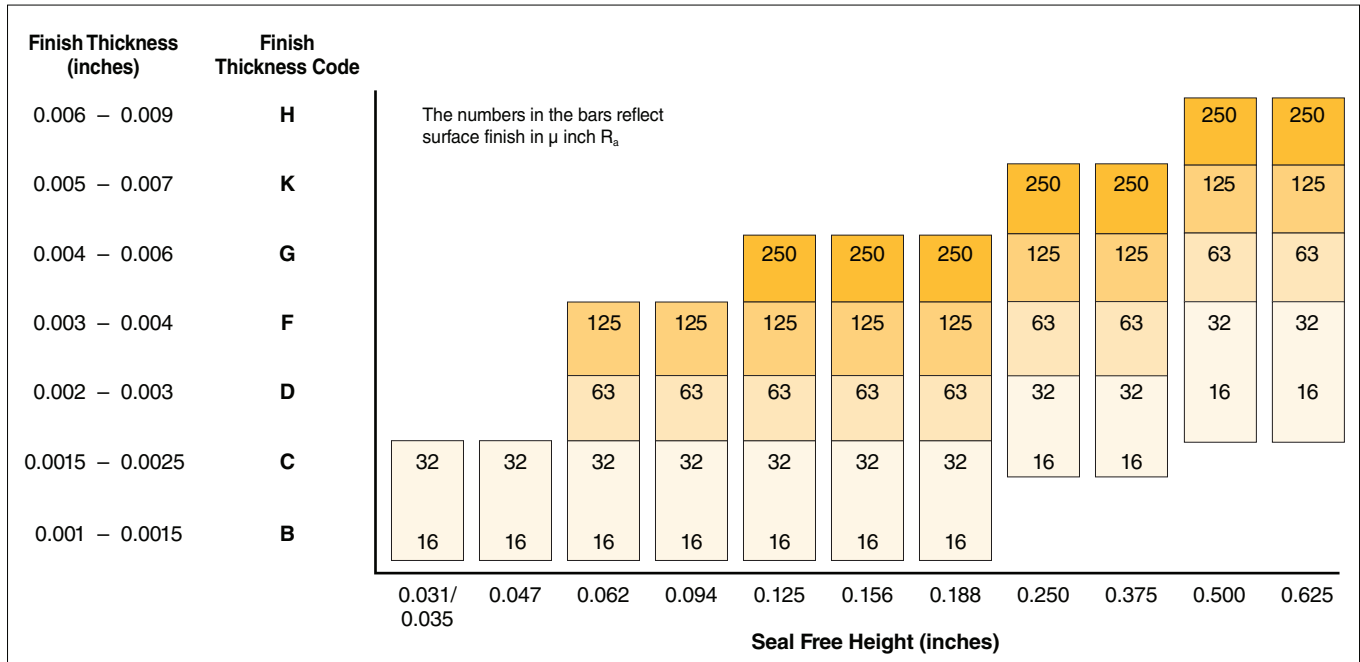

Available Finish Thicknesses	
Finish Thickness Code	P Finish Thickness (inches)
A	0.0005 – 0.001
B	0.001 – 0.0015
C	0.0015 – 0.0025
D	0.002 – 0.003
E	0.0025 – 0.0035
F	0.003 – 0.004
G	0.004 – 0.006
H	0.006 – 0.009
J	0.0035 – 0.005
K	0.005 – 0.007
M	0.004 – 0.005
N	0.001 – 0.002

**WARNING**  
 These products can expose you to chemicals including carbon black (airborne and extracts), antimony trioxide, titanium dioxide, silica (crystalline), di(2-ethylhexyl)phthalate, ethylene thiourea, acrylonitrile, 1,3-butadiene, epichlorohydrin, toluene diisocyanate, tetrafluoroethylene, ethylbenzene, formaldehyde, furfuryl alcohol, glass fibers, methyl isobutyl ketone, nickel (metallic and compounds), lead and lead compounds which are known to the state of California to cause cancer; and 1,3-butadiene, epichlorohydrin, di(2-ethylhexyl)phthalate, di-isodecyl phthalate, ethylene thiourea, methyl isobutyl ketone, methanol, toluene, lead and lead compounds which are known to the state of California to cause birth defects and other reproductive harm. For more information go to [www.P65Warnings.ca.gov](http://www.P65Warnings.ca.gov).

# Plating Information Silver-Indium

**Overview:**

Parker Hannifin's Silver-Indium diffused plating is a patent-pending electro-deposited plating process developed for metal seals exposed to hot, oxidizing environments. This new coating is specifically engineered to minimize the blistering and subsequent delamination often seen with plain silver or silver-gold composite coatings.



**Figure 1:** Blisters seen on a standard silver plated seal after 1,000 hours in air at 500°F



**Figure 2:** Parker Hannifin's Silver-Indium diffused plating

**Current Plating Technology:**

Silver plating is typically used to improve the performance of static metal seals by providing a ductile, low-hardness outer layer capable of conforming to irregularities in the mating surfaces. However, silver is easily permeated by oxygen at elevated temperatures, leading to oxidation of the underlying substrate. This oxidation causes the silver plating to lose adhesion and blister. As a result, silver and silver gold composite coatings are generally limited to application temperatures less than 500°F.

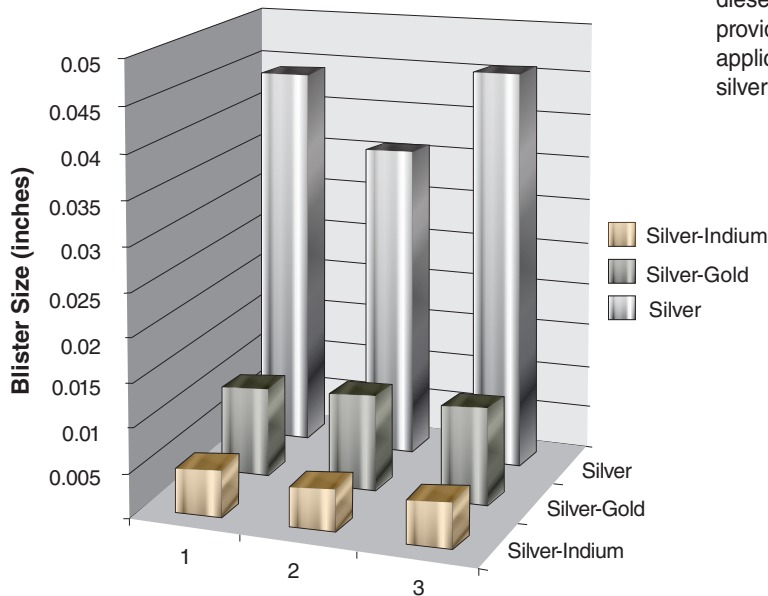

**Figure 3:** Blister size of Silver, Silver-Gold, and Silver-Indium samples after 500 hours in air at 1150°F.

**WARNING**

These products can expose you to chemicals including carbon black (airborne and extracts), antimony trioxide, titanium dioxide, silica (crystalline), di(2-ethylhexyl)phthalate, ethylene thiourea, acrylonitrile, 1,3-butadiene, epichlorohydrin, toluene diisocyanate, tetrafluoroethylene, ethylbenzene, formaldehyde, furfuryl alcohol, glass fibers, methyl isobutyl ketone, nickel (metallic and compounds), lead and lead compounds which are known to the state of California to cause cancer; and 1,3-butadiene, epichlorohydrin, di(2-ethylhexyl)phthalate, di-isodecyl phthalate, ethylene thiourea, methyl isobutyl ketone, methanol, toluene, lead and lead compounds which are known to the state of California to cause birth defects and other reproductive harm. For more information go to [www.P65Warnings.ca.gov](http://www.P65Warnings.ca.gov).

One method used to combat silver blistering is to add a thin layer of gold between the substrate and the silver plate. The dense gold layer retards the diffusion of oxygen, thereby reducing the incidence of blisters. Although this method is highly effective, it is prohibitively expensive for general or high volume use.

**The Parker Solution:**

Parker's solution incorporates a unique heat treatment process to diffuse a thin layer of indium into the silver plating, producing a soft but robust surface that is more resistant to high temperature blistering than either silver or silver-gold composite coatings. The diffused indium prevents oxygen diffusion through the plating layer in two ways. First, the indium binds to oxygen at both the surface and within the plating matrix, forming stable oxides. Second, the indium fills inter-spatial voids within the silver plating, effectively blocking atomic diffusion of oxygen atoms, thereby preventing them from reaching the underlying substrate.

**Performance:**

Long-term testing confirms that Parker's new Silver-Indium diffused plating is significantly better at reducing blister formation and subsequent delamination when compared to plain silver or silver gold composite coatings. And, because Silver-Indium retains its ductility during and after high-temperature exposure, sealing performance is fully maintained.

**Applications:**

Silver-Indium plating is suitable for use in applications currently using plain silver or silver-gold composite coatings for enhanced sealing performance, including aerospace, automotive, and heavy diesel applications. In addition, the added oxidation resistance provided by Silver-Indium allows it to be used in high temperature applications (up to 1150°F) well beyond the capability of standard silver and silver gold composite coatings.

# Metal Seal Platings, Coatings and Finishes

## TriCom®

TriCom is a proprietary electrodeposited composite tribological coating developed to provide excellent wear and oxidation protection for metallic sealing systems. TriCom comprises a unique matrix of cobalt co-deposited with chromium carbide ( $Cr_3C_2$ ) particles to create a wear and oxidation resistant system for prolonged use at 1150°F and limited use at 1250°F.

TriCom is designed to significantly reduce the wear of metallic sealing elements and the respective mating surfaces caused by thermal expansion and vibrational movement.

The unique wear characteristics, excellent bond strength, and ease of application of TriCom make it an excellent candidate for application on thin flexible sealing members. These characteristics provide TriCom a competitive advantage when compared with other coating alternatives. Bond strength testing has been performed to show that TriCom will continue to adhere to a seal under bending loads that would cause a comparable thermal sprayed coating to spall.

Table 1 – TriCom Characteristics	
Hardness (as-coated)	300-350 HVN 29 - 35 HRC
As-Coated Surface Finish	32 $\mu$ m Ra or better
Coating Thickness	As specified (.001 to .005 in. typical)
Service Temperature	1250° F (621° C) Max.

### Coating Structure:

TriCom is a composite coating containing finely dispersed chromium carbide particles (Figure 1). Cobalt in the coating matrix provides high temperature lubricity. Chromium carbide reduces the wear rate by acting as a solid lubricant when partially oxidized. When TriCom is heated in air, cobalt oxide and chromium oxide is formed on the surface of the coating creating a lubricious oxide glaze that protects the coating and counter face from wear. The oxide glaze physically separates the parts and allows them to glide over each other, minimizing wear on both surfaces while preserving sealing integrity.

### Coating Performance:

Extensive testing has been performed at ambient and elevated temperatures to characterize the capabilities and service limits of TriCom.

The results of independent ambient temperature wear tests of uncoated, TriCom coated, and Tribaloy T-800 coated samples are presented in (Figure 2). Samples were weighed before and after a linear reciprocating wear test to determine mass lost to wear. TriCom reduced wear of coated and uncoated counter faces to levels lower than T-800 or systems without coatings.

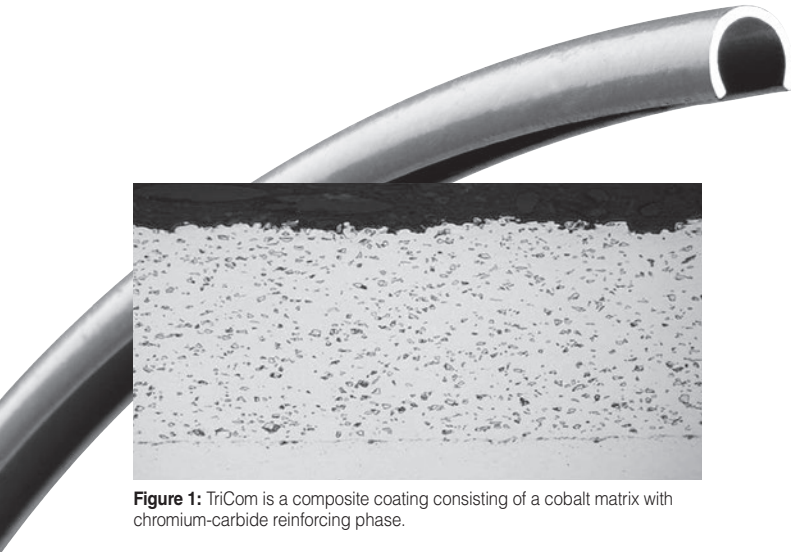

Figure 1: TriCom is a composite coating consisting of a cobalt matrix with chromium-carbide reinforcing phase.



Figure 2: Pin on Flat Wear Test Results for Alloy 718 Coated with TriCom and Tribaloy T-800.

### ⚠ WARNING

These products can expose you to chemicals including carbon black (airborne and extracts), antimony trioxide, titanium dioxide, silica (crystalline), di(2-ethylhexyl)phthalate, ethylene thiourea, acrylonitrile, 1,3-butadiene, epichlorohydrin, toluene diisocyanate, tetrafluoroethylene, ethylbenzene, formaldehyde, furfuryl alcohol, glass fibers, methyl isobutyl ketone, nickel (metallic and compounds), lead and lead compounds which are known to the state of California to cause cancer; and 1,3-butadiene, epichlorohydrin, di(2-ethylhexyl)phthalate, di-isodecyl phthalate, ethylene thiourea, methyl isobutyl ketone, methanol, toluene, lead and lead compounds which are known to the state of California to cause birth defects and other reproductive harm. For more information go to [www.P65Warnings.ca.gov](http://www.P65Warnings.ca.gov).

## TriCom® (cont.)

TriCom has also performed well in elevated temperature tests. A coated 10mm diameter ball was tested in linear reciprocating contact at 1350°F. The sample was worn against an uncoated Alloy 718 at a contact stress of 46 ksi for a total distance of 4.9 miles without wearing through the coating (Figure 3).

Table 2 – Test Parameters for Oscillating Wear Tests	
Test Laboratory	IMR Labs, Ithaca, NY
Motion	Oscillatory – 0.1 in stroke (2.54 mm)
Frequency	15 cycles/min.
Test Duration	1000 cycles
Temperature	68° F (20° C)
Contact	Chamfered pin against flat
Contact Stress	14.5 ksi (100 MPa)

In high frequency wear tests at 1350° F (modified ASTM D5707 method), TriCom caused less wear on the counter face than other nickel-cobalt based anti-wear coatings.

### Benefits Over Thermal Spray Coatings

Thermal sprayed coatings often need grinding or polishing to meet tight tolerances and ensure a good surface finish. TriCom coated parts are typically coated to net shape with no necessary secondary operations. The coating may be polished or ground to meet a customer's specific requirements if necessary.

The TriCom coating process will not deform thin parts. The thermal spray process will cause dimensional distortion in thin sections as the spray jet impinges upon the part.

Table 3 – Test Parameters for High Temperature Wear Tests	
Test Laboratory	Parker Hannifin Advanced Products, North Haven, CT
Motion	Linear Reciprocating (0.25 inch stroke)
Frequency	145 cycles/min.
Test Duration	622,500 cycles (72 hours)
Temperature	1150° F (621° C)
Contact	10 mm ball on flat
Contact Stress	46.0 ksi (317 MPa)

### Applications:

TriCom is typically applied to temperature resistant metals including stainless steel, nickel and cobalt super alloys. TriCom is suitable for use in mildly oxidizing environments, such as air, and carburizing atmospheres including exhaust gasses. Common applications include resilient metal sealing components in land based and aviation gas turbines.

TriCom wears well against most metals, including stainless steel, nickel and cobalt alloys, and cast iron. TriCom should be used in high contact stress systems that experience wear due to differential thermal expansion and vibration. TriCom is best suited for predominately static applications but has been utilized successfully in low speed dynamic systems

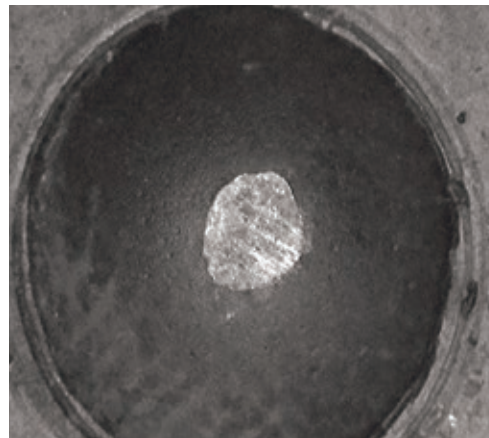

Figure 3: TriCom exhibited excellent wear resistance at 1150° F, surviving 4.9 miles of sliding wear on a 10mm ball. Wear scar diameter is 0.022 inches.



### ⚠️ WARNING

These products can expose you to chemicals including carbon black (airborne and extracts), antimony trioxide, titanium dioxide, silica (crystalline), di(2-ethylhexyl)phthalate, ethylene thiourea, acrylonitrile, 1,3-butadiene, epichlorohydrin, toluene diisocyanate, tetrafluoroethylene, ethylbenzene, formaldehyde, furfuryl alcohol, glass fibers, methyl isobutyl ketone, nickel (metallic and compounds), lead and lead compounds which are known to the state of California to cause cancer; and 1,3-butadiene, epichlorohydrin, di(2-ethylhexyl)phthalate, di-isodecyl phthalate, ethylene thiourea, methyl isobutyl ketone, methanol, toluene, lead and lead compounds which are known to the state of California to cause birth defects and other reproductive harm. For more information go to [www.P65Warnings.ca.gov](http://www.P65Warnings.ca.gov).



## Metal Seal Platings, Coatings and Finishes

### TriCom-HT™

TriCom-HT is a proprietary electro-deposited coating developed to provide excellent wear and oxidation resistance for high temperature metal seals and sealing components. TriCom-HT comprises a unique cobalt-nickel alloy matrix co-deposited with chromium carbide ( $Cr_3C_2$ ) and MCrAlY particles to provide a wear and oxidation resistant system for prolonged use at 1400°F (760°C) and limited exposure up to 1550°F (843°C).

TriCom-HT is designed to significantly reduce the wear of metallic sealing elements caused by thermal expansion and vibrational movement between mating surfaces.

#### Coating Structure:

TriCom-HT is a composite tribological coating containing finely dispersed reinforcing phases of chromium carbide and MCrAlY particles (Figure 1). Cobalt in the coating matrix provides high temperature lubricity while nickel provides ductility, oxidation resistance and increased hardness to prevent abrasive wear. Chromium carbide reduces the wear rate by acting as a solid lubricant when partially oxidized. MCrAlY is used as a vehicle to introduce strong oxide forming metals into the coating to increase oxidation resistance and coating adhesion to the substrate. Upon heating in air, chromium oxide, alumina and yttria form within the coating matrix, slowing further oxidation of the coating. Cobalt oxide and chromium oxide also form on the coating surface, providing a lubricious oxide glaze that decreases both the coating and counter face wear rates (Figure 2).

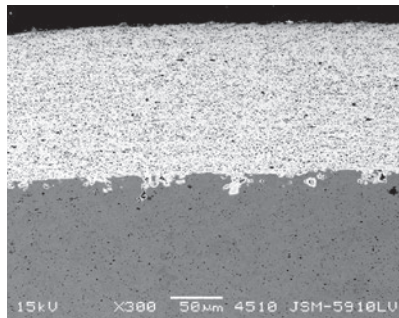

**Figure 1:** TriCom-HT is a composite coating consisting of a cobalt-nickel matrix with chromium carbide and MCrAlY reinforcing phases.

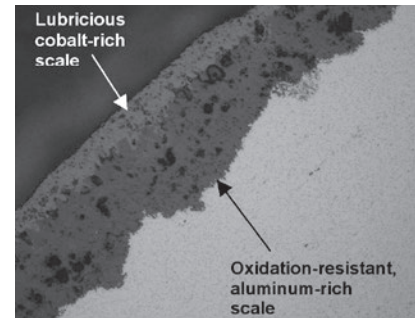

**Figure 2:** TriCom-HT forms a multi-layer oxide scale at service temperatures to simultaneously slow oxidation and wear.



#### Coating Performance:

TriCom-HT is designed to balance wear resistance with oxidation resistance to provide a long lasting solution to high temperature wear. TriCom-HT was tested using a high temperature linear reciprocating wear tester to fully evaluate the coating at each stage of development.

The unique composition of TriCom-HT significantly improves oxidation and wear behavior compared to typical cobalt chromium carbide coatings (Figure 3), extending the service temperature and life of the coating. In high temperature, high frequency friction and wear tests (modified ASTM D 5707 method) TriCom-HT coated samples exhibited less wear than samples coated with a cobalt chromium carbide coating. The wear rate of TriCom-HT coated samples remained stable throughout the test temperature range of 1350°F to 1500°F (732°C to 816°C).

#### ⚠ WARNING

These products can expose you to chemicals including carbon black (airborne and extracts), antimony trioxide, titanium dioxide, silica (crystalline), di(2-ethylhexyl)phthalate, ethylene thiourea, acrylonitrile, 1,3-butadiene, epichlorohydrin, toluene diisocyanate, tetrafluoroethylene, ethylbenzene, formaldehyde, furfuryl alcohol, glass fibers, methyl isobutyl ketone, nickel (metallic and compounds), lead and lead compounds which are known to the state of California to cause cancer; and 1,3-butadiene, epichlorohydrin, di(2-ethylhexyl)phthalate, di-isodecyl phthalate, ethylene thiourea, methyl isobutyl ketone, methanol, toluene, lead and lead compounds which are known to the state of California to cause birth defects and other reproductive harm. For more information go to [www.P65Warnings.ca.gov](http://www.P65Warnings.ca.gov).



## TriCom-HT™ (cont.)

Table 3 compares the oxidation behavior of TriCom-HT to competitive wear resistant coatings at 1350°F (732°C). The oxidation rate of TriCom-HT approximates that of nickel-based coatings, and is an order of magnitude better than typical cobalt chromium carbide coatings.

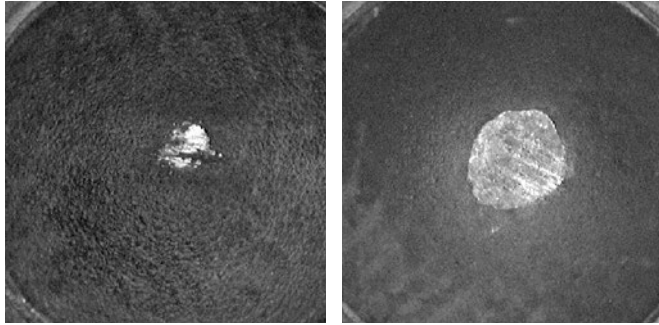

**Figure 3:** Wear scar on coated spheres from high temperature ball-on-flat wear tests. TriCom-HT (at left) exhibits significantly less wear after 72-hours at 1350°F (732°C) than a typical cobalt chromium carbide coating (right). Contact stress was 46 ksi (317 MPa) and total wear distance was 4.9 miles (7.9 km).

### Applications:

TriCom-HT is typically applied to temperature resistant metals including stainless steels, nickel and cobalt superalloys. TriCom-HT works well in both oxidizing environments, such as air, and carburizing atmospheres including exhaust gases.

TriCom-HT is suitable for any high temperature static sealing application where differential thermal expansion or vibrational wear may occur. Typical applications include resilient metal seals, sealing components for land based and aviation gas turbines, and diesel exhaust components.



**Figure 4:** TriCom-HT prevents wear in high load metal to metal sealing applications such as these automotive exhaust manifold couplers.

**Table 1: TriCom-HT Characteristics**

Hardness	450-500 HVN 45 - 49 HRC
As-Coated Surface Finish	64 µin (1.6 µm) Ra or Better
Coating Thickness	As Specified .001 to .005 in. (0.025 to 0.127 mm) Typical
Service Temperature	1400°F (760°C) Continuous 1550°F (843°C) Maximum

**Table 2: Test Parameters for High Temperature Wear Tests**

Test Laboratory	Parker Hannifin Advanced Products – North Haven, CT
Motion	Linear Reciprocating (0.25 inch stroke)
Frequency	145 cycles/min
Test Duration	622,500 cycles (72 hours)
Temperature	1350°F (732°C)
Contact	10 mm ball-on-flat
Contact Stress	46.0 ksi (317 MPa)

**Table 3: Oxidation Testing at 1350°F for 72 Hours in Air**

Coating	Scale Thickness
TriCom-HT	5.8 x 10 <sup>-4</sup> in
Cobalt Chromium Carbide Coating	1.9 x 10 <sup>-3</sup> in
Nickel Chromium Carbide Coating	3.5 x 10 <sup>-4</sup> in

### ⚠️ WARNING

These products can expose you to chemicals including carbon black (airborne and extracts), antimony trioxide, titanium dioxide, silica (crystalline), di(2-ethylhexyl)phthalate, ethylene thiourea, acrylonitrile, 1,3-butadiene, epichlorohydrin, toluene diisocyanate, tetrafluoroethylene, ethylbenzene, formaldehyde, furfuryl alcohol, glass fibers, methyl isobutyl ketone, nickel (metallic and compounds), lead and lead compounds which are known to the state of California to cause cancer; and 1,3-butadiene, epichlorohydrin, di(2-ethylhexyl)phthalate, di-isodecyl phthalate, ethylene thiourea, methyl isobutyl ketone, methanol, toluene, lead and lead compounds which are known to the state of California to cause birth defects and other reproductive harm. For more information go to [www.P65Warnings.ca.gov](http://www.P65Warnings.ca.gov).



 **WARNING**

These products can expose you to chemicals including carbon black (airborne and extracts), antimony trioxide, titanium dioxide, silica (crystalline), di(2-ethylhexyl)phthalate, ethylene thiourea, acrylonitrile, 1,3-butadiene, epichlorohydrin, toluene diisocyanate, tetrafluoroethylene, ethylbenzene, formaldehyde, furfuryl alcohol, glass fibers, methyl isobutyl ketone, nickel (metallic and compounds), lead and lead compounds which are known to the state of California to cause cancer; and 1,3-butadiene, epichlorohydrin, di(2-ethylhexyl)phthalate, di-isodecyl phthalate, ethylene thiourea, methyl isobutyl ketone, methanol, toluene, lead and lead compounds which are known to the state of California to cause birth defects and other reproductive harm. For more information go to [www.P65Warnings.ca.gov](http://www.P65Warnings.ca.gov).

# Section E – Technical Information

This section provides additional information about Metal Seal design, use and performance. It allows the design engineer to fine tune the cavity requirements to ensure optimum seal performance.

<b>This section includes:</b>	<b>Page</b>
<b>Performance Data</b>	
Load, Deflection and Springback / Terminology .....	E-68
Metal C-Ring Performance .....	E-70
Metal E-Ring Performance .....	E-72
Metal U-Ring Performance .....	E-73
Metal O-Ring Performance .....	E-74
Metal Energized C-Ring Performance .....	E-76
Metal Wire Ring Performance .....	E-77
<b>Leak Rate Information</b> .....	E-78
<b>Fatigue and Stress Relaxation</b> .....	E-79
<b>Installation Guidelines</b>	
Surface Roughness .....	E-80
Surface Flatness.....	E-80
Surface Hardness .....	E-81
Compression Limiters .....	E-81
Bolt Load and Tightening Torque Guidelines .....	E-82
<b>Seal Shaping Requirements for Non-Circular Seals</b> .....	E-84
<b>Metal Seal Manufacturing Specifications</b>	
Metal Seal Roundness and Flatness.....	E-85
Metal Seal Surface Finish.....	E-85
Metal O-Ring Weld Finish.....	E-85
<b>Preferred C-Ring and Spring Energized C-Ring Sizes</b> .....	E-86
<b>Tolerance Reference Table</b> .....	E-92
<b>Conversion Tables</b> .....	E-93

**WARNING**

These products can expose you to chemicals including carbon black (airborne and extracts), antimony trioxide, titanium dioxide, silica (crystalline), di(2-ethylhexyl)phthalate, ethylene thiourea, acrylonitrile, 1,3-butadiene, epichlorohydrin, toluene diisocyanate, tetrafluoroethylene, ethylbenzene, formaldehyde, furfuryl alcohol, glass fibers, methyl isobutyl ketone, nickel (metallic and compounds), lead and lead compounds which are known to the state of California to cause cancer; and 1,3-butadiene, epichlorohydrin, di(2-ethylhexyl)phthalate, di-isodecyl phthalate, ethylene thiourea, methyl isobutyl ketone, methanol, toluene, lead and lead compounds which are known to the state of California to cause birth defects and other reproductive harm. For more information go to [www.P65Warnings.ca.gov](http://www.P65Warnings.ca.gov).



## Performance Data

### Load, Deflection and Springback

All metal seals, except for metal wire rings, are designed to undergo both plastic and elastic deformation when installed. (Wire rings are essentially limited to plastic deformation only.)

**Plastic deformation** of the jacket, or O-ring tubing, enlarges the contact area, or “footprint”, to bridge across surface imperfections or tool marks in the mating surfaces. It also creates a reduced gradient in the load/deflection curve to permit a wide tolerance in the working height, resulting in a robust sealing process. High integrity sealing is ensured by the ductile outer layer or coating which, being inelastic and of low compressive yield strength, flows into and fills the mating surface crevices.

**Elastic deformation** provides elastic recovery or “springback” to maintain good sealing, despite separation of the mating surfaces due to the effects of thermal cycling, flange rotation, applied mechanical or hydrostatic loads or creep.

### Terminology

**Free Height:** The cross-sectional height of an uncompressed seal. This is conventionally stated before platings or coatings.

**Working Height:** The cross-sectional height of an installed seal, which is equivalent to the groove depth. Many metal seals allow wide tolerance in the permissible working height to accommodate tolerance stack ups.

**Seating Load:** The load required to compress a seal to the working height. For convenience, all loads are conventionally stated per unit circumferential length. Generally, a higher seating load will ensure greater leak tightness.

**Springback:** The difference between the working height and the (reduced) free height after all applied loads have been released: this represents the total elastic recovery of the seal.

**Useful Springback:** That portion of the spring-back curve where the load exceeds 20-25% of the load at working height. Below this, the load may be insufficient to maintain good seal performance.

**Working, Proof and Burst Pressures:** The working pressures given in this design guide are the maximum for both steady-state and cyclical pressures (subject to fatigue considerations) with the groove to seal diametrical clearances recommended in Section C. Where high pressure transients are expected, or installed seals are subject to a proof test (as part of a 100% acceptance test, not a type test), designers should select a metal seal with a working pressure sufficient to accommodate such high pressure exposures.

Burst testing may be performed at pressures higher than the rated working pressure. Experience has shown that pressure energized metal seals will seal effectively at pressures significantly beyond their working pressure, although some permissible permanent deformation of the seal may occur.

Leakage failure may occur at extremely high pressures, however, this is typically the result of flange or joint separation or distortion, due to the high hydrostatic loads under such conditions. The onset of leakage will be detected when such flange separation exceeds the useful springback of the seal.







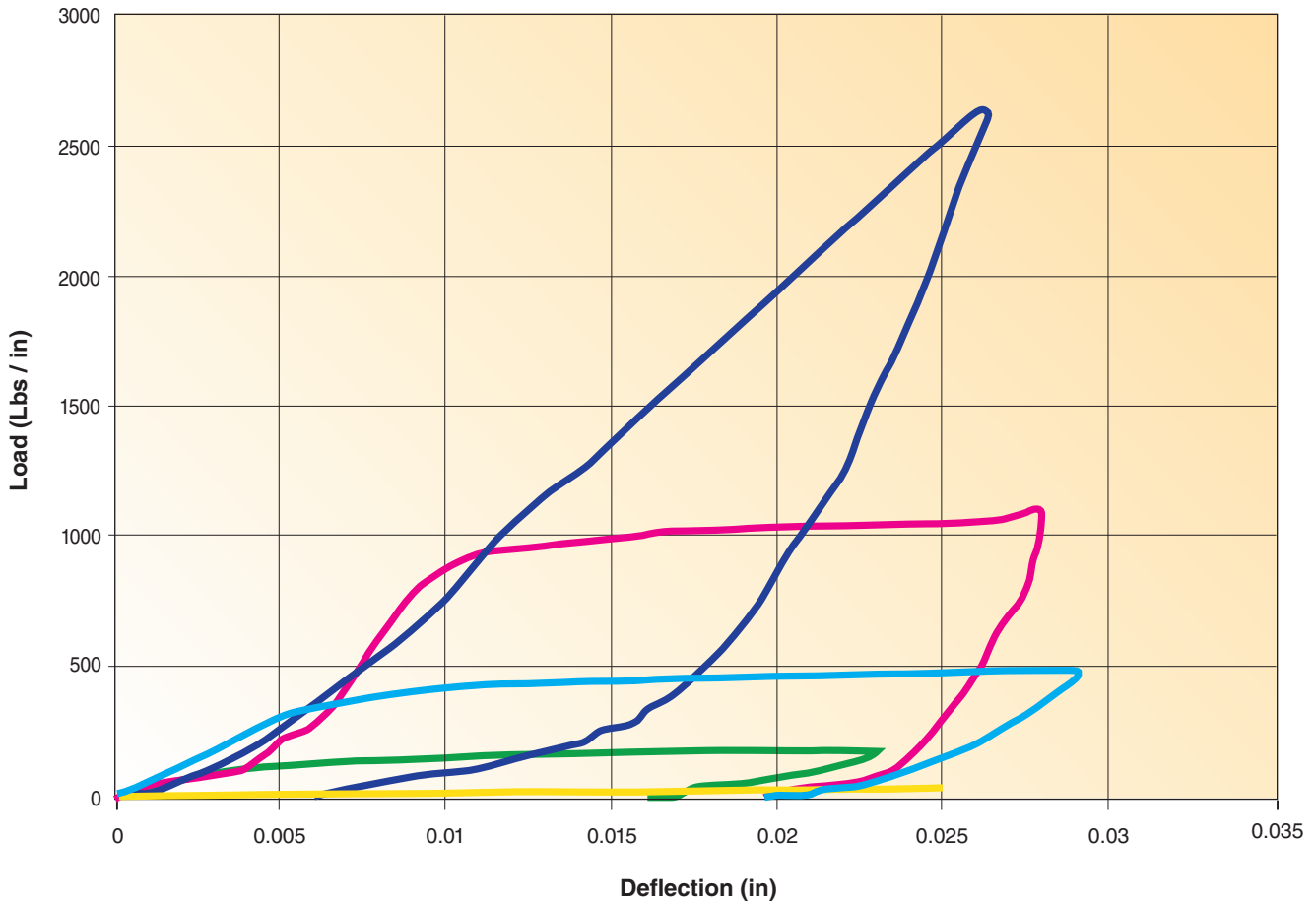

#### **⚠ WARNING**

These products can expose you to chemicals including carbon black (airborne and extracts), antimony trioxide, titanium dioxide, silica (crystalline), di(2-ethylhexyl)phthalate, ethylene thiourea, acrylonitrile, 1,3-butadiene, epichlorohydrin, toluene diisocyanate, tetrafluoroethylene, ethylbenzene, formaldehyde, furfuryl alcohol, glass fibers, methyl isobutyl ketone, nickel (metallic and compounds), lead and lead compounds which are known to the state of California to cause cancer; and 1,3-butadiene, epichlorohydrin, di(2-ethylhexyl)phthalate, di-isodecyl phthalate, ethylene thiourea, methyl isobutyl ketone, methanol, toluene, lead and lead compounds which are known to the state of California to cause birth defects and other reproductive harm. For more information go to [www.P65Warnings.ca.gov](http://www.P65Warnings.ca.gov).

# Load, Deflection and Springback

## Load vs Deflection Comparison



-  **EEI: metal E-ring**
-  **ECI: metal C-Ring**
-  **ESI: spring energized metal C-ring**
-  **EOI: metal O-ring**
-  **EWI: metal wire ring**

**⚠️ WARNING**

These products can expose you to chemicals including carbon black (airborne and extracts), antimony trioxide, titanium dioxide, silica (crystalline), di(2-ethylhexyl)phthalate, ethylene thiourea, acrylonitrile, 1,3-butadiene, epichlorohydrin, toluene diisocyanate, tetrafluoroethylene, ethylbenzene, formaldehyde, furfuryl alcohol, glass fibers, methyl isobutyl ketone, nickel (metallic and compounds), lead and lead compounds which are known to the state of California to cause cancer; and 1,3-butadiene, epichlorohydrin, di(2-ethylhexyl)phthalate, di-isodecyl phthalate, ethylene thiourea, methyl isobutyl ketone, methanol, toluene, lead and lead compounds which are known to the state of California to cause birth defects and other reproductive harm. For more information go to [www.P65Warnings.ca.gov](http://www.P65Warnings.ca.gov).



## Performance Data

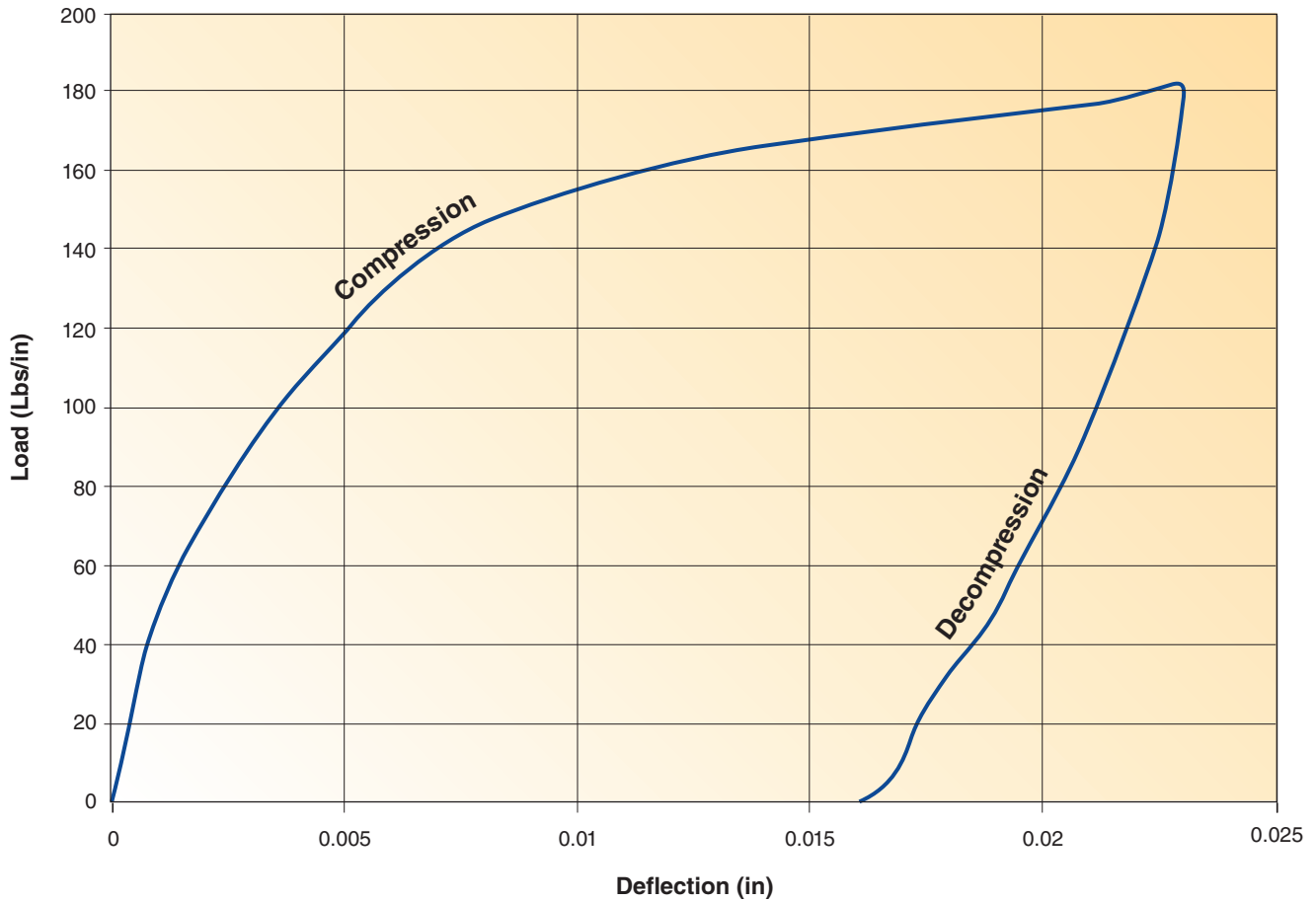

**⚠ WARNING**

These products can expose you to chemicals including carbon black (airborne and extracts), antimony trioxide, titanium dioxide, silica (crystalline), di(2-ethylhexyl)phthalate, ethylene thiourea, acrylonitrile, 1,3-butadiene, epichlorohydrin, toluene diisocyanate, tetrafluoroethylene, ethylbenzene, formaldehyde, furfuryl alcohol, glass fibers, methyl isobutyl ketone, nickel (metallic and compounds), lead and lead compounds which are known to the state of California to cause cancer; and 1,3-butadiene, epichlorohydrin, di(2-ethylhexyl)phthalate, di-isodecyl phthalate, ethylene thiourea, methyl isobutyl ketone, methanol, toluene, lead and lead compounds which are known to the state of California to cause birth defects and other reproductive harm. For more information go to [www.P65Warnings.ca.gov](http://www.P65Warnings.ca.gov).

Based on nominal seal dimensions, recommended cavity dimensions and ambient temperature. If working pressures exceed the above ratings consult us for recommendations.

Metal C-Ring Performance								
Nominal Cross Section	Free Height	Material Thickness	Cross Section Code	Temper Code	Material	Seating Load (pounds per inch circumference)	Springback (inches)	Working Pressure Rating (psi)
1/32	0.031	0.006	01	-6	Alloy X-750	140	0.0015	19000
					Alloy 718	160	0.0015	20000
					Waspaloy	140	0.0015	20000
		0.007	02	-6	Alloy X-750	200	0.001	24000
					Alloy 718	230	0.001	25000
					Waspaloy	200	0.001	25000
3/64	0.047	0.006	03	-6	Alloy X-750	90	0.002	9500
					Alloy 718	110	0.002	10000
					Waspaloy	90	0.002	10000
		0.008	04	-6	Alloy X-750	200	0.002	21000
					Alloy 718	230	0.002	22000
					Waspaloy	200	0.002	22000
1/16	0.062	0.006	05	-6	Alloy X-750	70	0.003	8000
					Alloy 718	80	0.003	8500
					Waspaloy	70	0.003	8500
		0.010	06	-6	Alloy X-750	250	0.002	21000
					Alloy 718	280	0.002	22000
					Waspaloy	250	0.002	22000
3/32	0.094	0.010	07	-6	Alloy X-750	140	0.005	8000
					Alloy 718	160	0.006	8500
					Waspaloy	140	0.005	8500
		0.015	08	-6	Alloy X-750	350	0.004	16500
					Alloy 718	400	0.005	17000
					Waspaloy	350	0.004	17000
1/8	0.125	0.015	09	-6	Alloy X-750	260	0.006	12000
					Alloy 718	300	0.007	12500
					Waspaloy	260	0.006	12500
		0.020	10	-6	Alloy X-750	550	0.005	20000
					Alloy 718	600	0.006	21000
					Waspaloy	550	0.005	21000
5/32	0.156	0.016	11	-6	Alloy X-750	220	0.008	8000
					Alloy 718	260	0.009	8500
					Waspaloy	220	0.008	8500
		0.024	12	-6	Alloy X-750	550	0.006	20000
					Alloy 718	600	0.007	21000
					Waspaloy	550	0.006	21000
3/16	0.188	0.020	13	-6	Alloy X-750	300	0.009	8500
					Alloy 718	350	0.010	9000
					Waspaloy	300	0.009	9000
		0.030	14	-6	Alloy X-750	650	0.007	22000
					Alloy 718	750	0.008	23000
					Waspaloy	650	0.007	23000
1/4	0.250	0.025	15	-6	Alloy X-750	350	0.011	7500
					Alloy 718	400	0.013	8000
					Waspaloy	350	0.011	8000
		0.038	16	-6	Alloy X-750	850	0.008	20000
					Alloy 718	1000	0.009	21000
					Waspaloy	850	0.008	21000
3/8	0.375	0.038	17	-6	Alloy X-750	500	0.017	7500
					Alloy 718	600	0.020	8000
					Waspaloy	500	0.017	8000
		0.050	18	-6	Alloy X-750	1300	0.013	20000
					Alloy 718	1500	0.015	21000
					Waspaloy	1300	0.013	21000
1/2	0.500	0.050	19	-6	Alloy X-750	700	0.022	7500
					Alloy 718	800	0.025	8000
					Waspaloy	700	0.022	8000
		0.065	20	-6	Alloy X-750	1500	0.017	20000
					Alloy 718	1700	0.020	21000
					Waspaloy	1500	0.017	21000

**WARNING**  
 These products can expose you to chemicals including carbon black (airborne and extracts), antimony trioxide, titanium dioxide, silica (crystalline), di(2-ethylhexyl)phthalate, ethylene thiourea, acrylonitrile, 1,3-butadiene, epichlorohydrin, toluene diisocyanate, tetrafluoroethylene, ethylbenzene, formaldehyde, furfuryl alcohol, glass fibers, methyl isobutyl ketone, nickel (metallic and compounds), lead and lead compounds which are known to the state of California to cause cancer; and 1,3-butadiene, epichlorohydrin, di(2-ethylhexyl)phthalate, di-isodecyl phthalate, ethylene thiourea, methyl isobutyl ketone, methanol, toluene, lead and lead compounds which are known to the state of California to cause birth defects and other reproductive harm. For more information go to [www.P65Warnings.ca.gov](http://www.P65Warnings.ca.gov).



## Performance Data

Metal E-Ring Performance								
Nominal Cross Section	Free Height	Material Thickness	Cross Section Code	Temper Code	Material	Seating Load (pounds per inch circum.)	Springback (inches)	Working Pressure Rating (psi)
1/16	0.074	0.005	05	-6	Alloy 718	30	0.009	1500
					Waspaloy	25	0.008	1500
3/32	0.108	0.010	07	-6	Alloy 718	40	0.018	1500
					Waspaloy	35	0.015	1500
1/8	0.139	0.010	08	-6	Alloy 718	90	0.013	5000
					Waspaloy	75	0.011	5000
1/8	0.139	0.012	09	-6	Alloy 718	45	0.021	1500
					Waspaloy	40	0.018	1500
3/16	0.218	0.012	10	-6	Alloy 718	60	0.020	5000
					Waspaloy	50	0.017	5000
3/16	0.218	0.015	13	-6	Alloy 718	50	0.035	2000
					Waspaloy	45	0.030	2000
1/4	0.295	0.020	15	-6	Alloy 718	80	0.046	2000
					Waspaloy	70	0.040	2000

Based on nominal seal dimensions, recommended cavity dimensions and ambient temperature. If working pressures exceed the above ratings consult Parker for recommendations. Refer to Page E-68 for a definition of the above performance terminology.

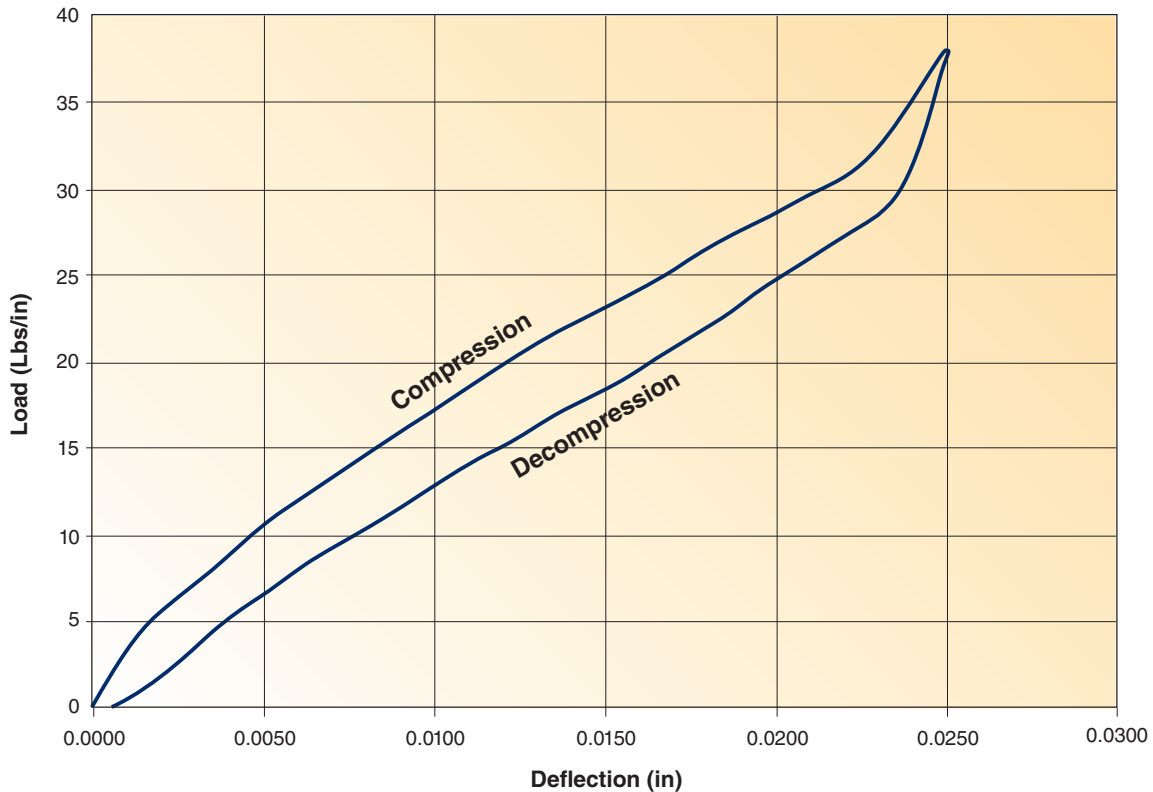

**WARNING**

These products can expose you to chemicals including carbon black (airborne and extracts), antimony trioxide, titanium dioxide, silica (crystalline), di(2-ethylhexyl)phthalate, ethylene thiourea, acrylonitrile, 1,3-butadiene, epichlorohydrin, toluene diisocyanate, tetrafluoroethylene, ethylbenzene, formaldehyde, furfuryl alcohol, glass fibers, methyl isobutyl ketone, nickel (metallic and compounds), lead and lead compounds which are known to the state of California to cause cancer; and 1,3-butadiene, epichlorohydrin, di(2-ethylhexyl)phthalate, di-isodecyl phthalate, ethylene thiourea, methyl isobutyl ketone, methanol, toluene, lead and lead compounds which are known to the state of California to cause birth defects and other reproductive harm. For more information go to [www.P65Warnings.ca.gov](http://www.P65Warnings.ca.gov).



Metal U-Ring Performance								
Nominal Cross Section	Free Height	Material Thickness	Cross Section Code	Temper Code	Material	Seating Load (pounds per inch circum.)	Springback (inches)	Working Pressure Rating (psi)
1/16	0.063	0.005	05	-6	Alloy 718 Waspaloy	30	0.006	10000
						25	0.005	10000
3/32	0.093	0.009	07	-6	Alloy 718 Waspaloy	40	0.010	12000
						40	0.009	12000
1/8	0.125	0.012	09	-6	Alloy 718 Waspaloy	50	0.014	12000
						45	0.012	12000
3/16	0.185	0.015	13	-6	Alloy 718 Waspaloy	50	0.020	8000
						45	0.017	8000
1/4	0.247	0.020	15	-6	Alloy 718 Waspaloy	70	0.026	8000
						60	0.023	8000

Based on nominal seal dimensions, recommended cavity dimensions and ambient temperature.



### EUI Metal U-Ring Performance

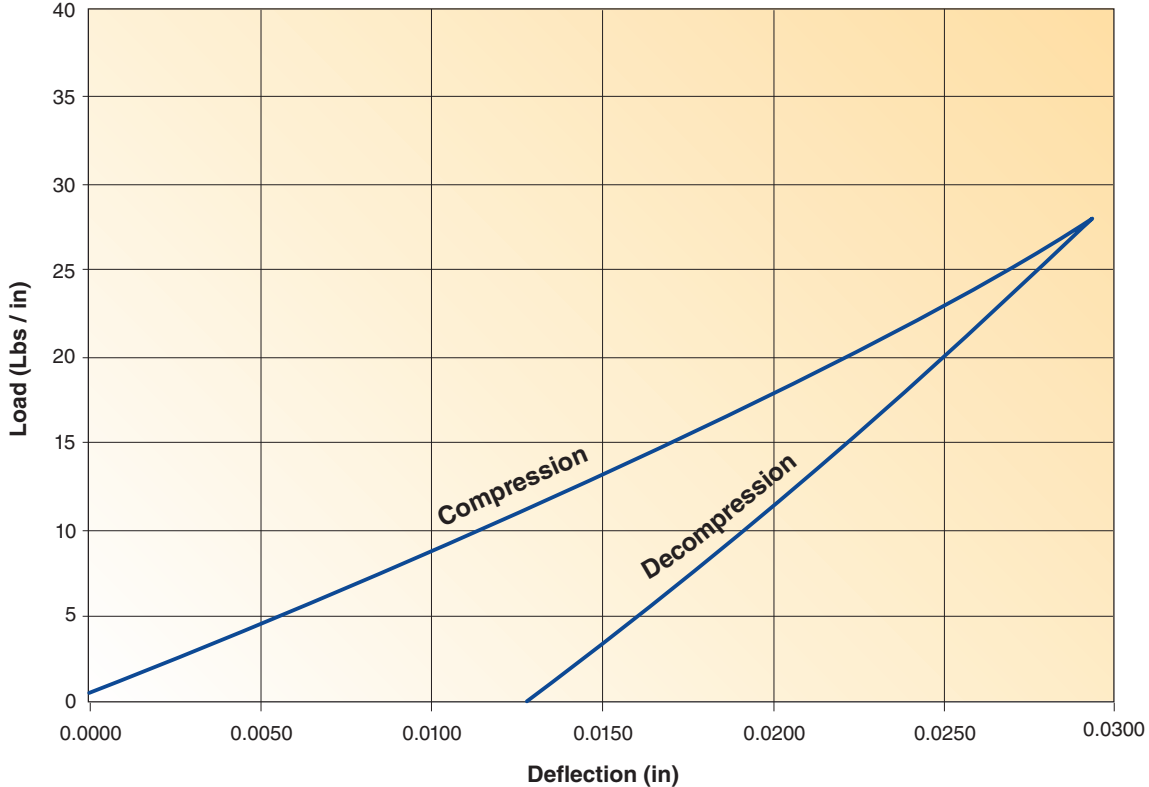

**WARNING**

These products can expose you to chemicals including carbon black (airborne and extracts), antimony trioxide, titanium dioxide, silica (crystalline), di(2-ethylhexyl)phthalate, ethylene thiourea, acrylonitrile, 1,3-butadiene, epichlorohydrin, toluene diisocyanate, tetrafluoroethylene, ethylbenzene, formaldehyde, furfuryl alcohol, glass fibers, methyl isobutyl ketone, nickel (metallic and compounds), lead and lead compounds which are known to the state of California to cause cancer; and 1,3-butadiene, epichlorohydrin, di(2-ethylhexyl)phthalate, di-isodecyl phthalate, ethylene thiourea, methyl isobutyl ketone, methanol, toluene, lead and lead compounds which are known to the state of California to cause birth defects and other reproductive harm. For more information go to [www.P65Warnings.ca.gov](http://www.P65Warnings.ca.gov).



# Performance Data

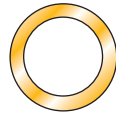

## EOI Metal O-Ring Performance

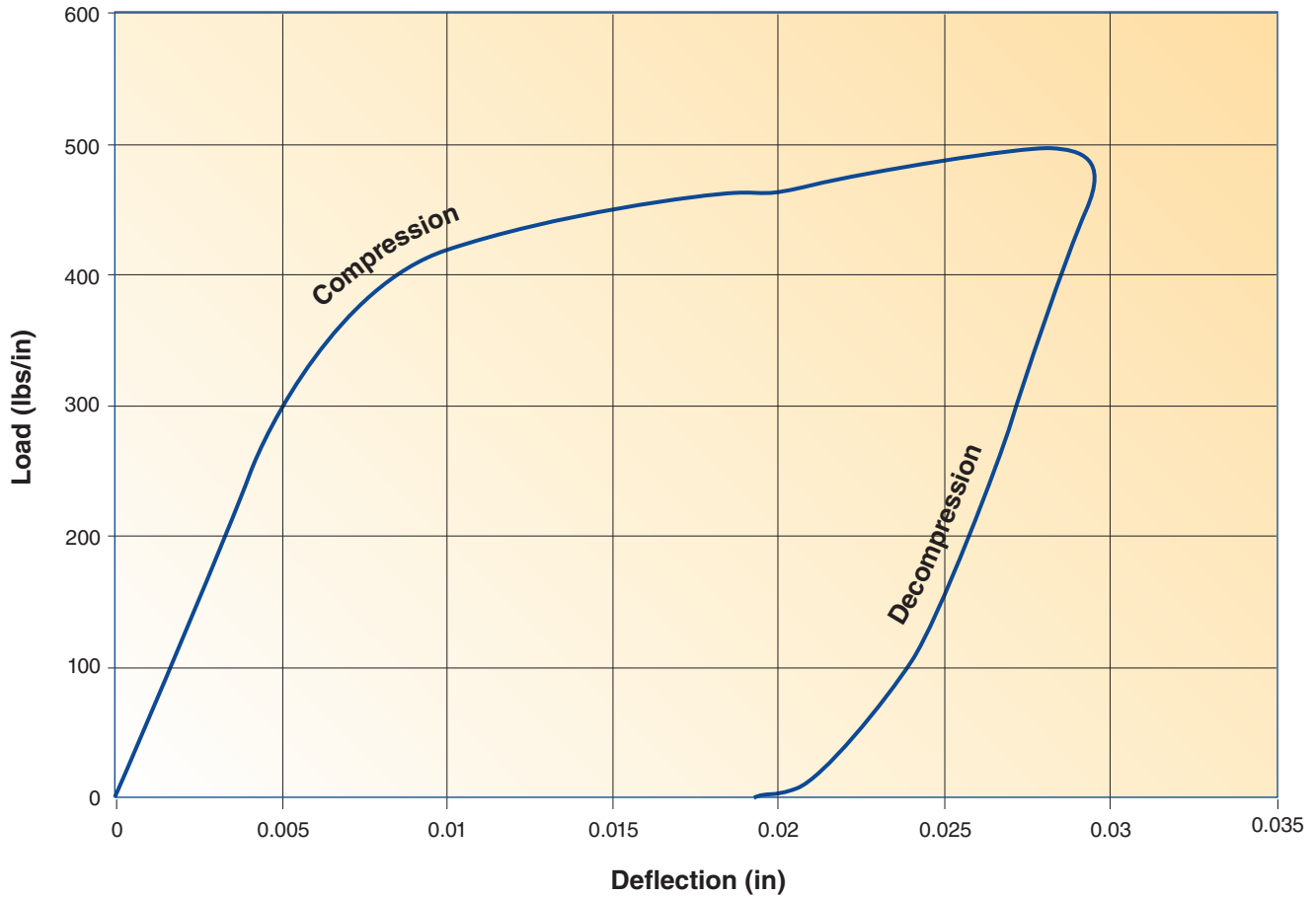

**⚠ WARNING**

These products can expose you to chemicals including carbon black (airborne and extracts), antimony trioxide, titanium dioxide, silica (crystalline), di(2-ethylhexyl)phthalate, ethylene thiourea, acrylonitrile, 1,3-butadiene, epichlorohydrin, toluene diisocyanate, tetrafluoroethylene, ethylbenzene, formaldehyde, furfuryl alcohol, glass fibers, methyl isobutyl ketone, nickel (metallic and compounds), lead and lead compounds which are known to the state of California to cause cancer; and 1,3-butadiene, epichlorohydrin, di(2-ethylhexyl)phthalate, di-isodecyl phthalate, ethylene thiourea, methyl isobutyl ketone, methanol, toluene, lead and lead compounds which are known to the state of California to cause birth defects and other reproductive harm. For more information go to [www.P65Warnings.ca.gov](http://www.P65Warnings.ca.gov).



Metal O-Ring Performance									
Nominal Cross Section	Free Height	Material Thickness	Cross Section Code	Temper Code	Material	Seating Load (pounds per inch circumference)	Springback (inches)	Working Pressure Rating (psi)	
								Vented	Non-Vented
1/32	0.035	0.006	01	-1	321 SS Alloy X-750	400	0.0005	10000	700
						550	0.0005	15000	1000
3/64	0.047	0.007	29	-1	321 SS Alloy X-750	400	0.001	7000	700
						550	0.001	10000	1000
1/16	0.062	0.006	02	-1	321 SS Alloy X-750	260 350	0.0015 0.002	4000 6500	600 900
			03	-1	321 SS Alloy X-750	550 750	0.001 0.0015	11000 16000	700 1000
		0.012	31	-1	321 SS Alloy X-750	800 1100	0.001 0.001	14000 20000	700 1100
			08	-1	321 SS Alloy X-750	1100 1500	0.001 0.001	17000 25000	800 1200
3/32	0.094	0.006	04	-1	321 SS Alloy X-750	150 200	0.002 0.002	1400 2000	700 1000
			05	-1	321 SS Alloy X-750	300 400	0.002 0.002	4000 6500	800 1100
		0.012	32	-1	321 SS Alloy X-750	400 550	0.001 0.0015	6500 10000	800 1200
			09	-1	321 SS Alloy X-750	1200 1600	0.001 0.0015	16500 25000	900 1300
1/8	0.125	0.008	06	-1	321 SS Alloy X-750	100 140	0.004 0.005	2500 4000	500 700
			07	-1	321 SS Alloy X-750	150 200	0.003 0.004	4500 6500	500 800
		0.012	25	-1	321 SS Alloy X-750	280 400	0.002 0.003	6500 10000	600 900
			10	-1	321 SS Alloy X-750	900 1200	0.002 0.002	16500 25000	700 1000
5/32	0.156	0.016	11	-1	304 SS Alloy X-750	400 550	0.004 0.005	4000 6500	700 1000
			12	-1	304 SS Alloy X-750	750 1000	0.003 0.004	13500 20000	700 1100
3/16	0.188	0.020	13	-1	304 SS Alloy X-750	450 600	0.004 0.005	4000 6500	700 1000
			14	-1	304 SS Alloy X-750	700 950	0.003 0.004	14500 22000	700 1100
1/4	0.250	0.025	15	-1	304 SS Alloy X-750	450 600	0.005 0.006	4000 6000	700 1000
			16	-1	304 SS Alloy X-750	950 1300	0.004 0.005	13500 20500	700 1100
3/8	0.375	0.038	17	-1 -6	304 SS Alloy 718	650 1000	0.006 0.009	4000 8000	1100 1600
			18	-1 -6	304 SS Alloy 718	1100 1700	0.005 0.007	7500 14500	1300 2000
1/2	0.500	0.050	19	-1 -6	304 SS Alloy 718	1000 2400	0.009 0.017	4000 8000	1100 1600
			20	-1 -6	304 SS Alloy 718	1700 3800	0.007 0.012	7500 14500	1300 2000
5/8	0.625	0.063	21	-1 -6	304 SS Alloy 718	1400 3300	0.011 0.020	4000 8000	1100 1600

Based on nominal seal dimensions, recommended cavity dimensions, and ambient temperature. If working pressures exceed the above ratings consult us for recommendations. Refer to Page E-68 for a definition of the above performance terminology.

**WARNING**

These products can expose you to chemicals including carbon black (airborne and extracts), antimony trioxide, titanium dioxide, silica (crystalline), di(2-ethylhexyl)phthalate, ethylene thiourea, acrylonitrile, 1,3-butadiene, epichlorohydrin, toluene diisocyanate, tetrafluoroethylene, ethylbenzene, formaldehyde, furfuryl alcohol, glass fibers, methyl isobutyl ketone, nickel (metallic and compounds), lead and lead compounds which are known to the state of California to cause cancer; and 1,3-butadiene, epichlorohydrin, di(2-ethylhexyl)phthalate, di-isodecyl phthalate, ethylene thiourea, methyl isobutyl ketone, methanol, toluene, lead and lead compounds which are known to the state of California to cause birth defects and other reproductive harm. For more information go to [www.P65Warnings.ca.gov](http://www.P65Warnings.ca.gov).



# Performance Data

Spring Energized Metal C-Ring Performance							
Nominal Cross Section	Free Height	Cross Section Code	Temper Code	Material		Seating Load (pounds per inch circum.)	Springback (inches)
				Jacket	Spring		
1/16	0.062	05	-1	304 SS	304 SS	450	0.003
				Alloy X-750	Alloy X-750	500	0.003
				Alloy 718	Alloy 718	550	0.003
3/32	0.094	07	-1	304 SS	304 SS	800	0.004
				Alloy X-750	Alloy X-750	850	0.005
				Alloy 718	Alloy 718	900	0.006
1/8	0.125	09	-1	304 SS	304 SS	900	0.005
				Alloy X-750	Alloy X-750	950	0.006
				Alloy 718	Alloy 718	1000	0.007
5/32	0.156	11	-1	304 SS	304 SS	1200	0.007
				Alloy X-750	Alloy X-750	1300	0.008
				Alloy 718	Alloy 718	1400	0.009
3/16	0.188	13	-1	304 SS	304 SS	1400	0.008
				Alloy X-750	Alloy X-750	1500	0.009
				Alloy 718	Alloy 718	1600	0.010
1/4	0.250	15	-1	304 SS	304 SS	1900	0.010
				Alloy X-750	Alloy X-750	2000	0.011
				Alloy 718	Alloy 718	2100	0.012
3/8	0.375	17	-1	304 SS	304 SS	2400	0.015
				Alloy X-750	Alloy X-750	2500	0.017
				Alloy 718	Alloy 718	2600	0.018
1/2	0.500	19	-1	304 SS	304 SS	2800	0.020
				Alloy X-750	Alloy X-750	2900	0.022
				Alloy 718	Alloy 718	3100	0.024

Based on nominal seal dimensions, recommended cavity dimensions and ambient temperature. If working pressures exceed the above ratings consult Parker for recommendations. Refer to Page E-68 for a definition of the above performance terminology.



## ESi Spring Energized Metal C-Ring Performance

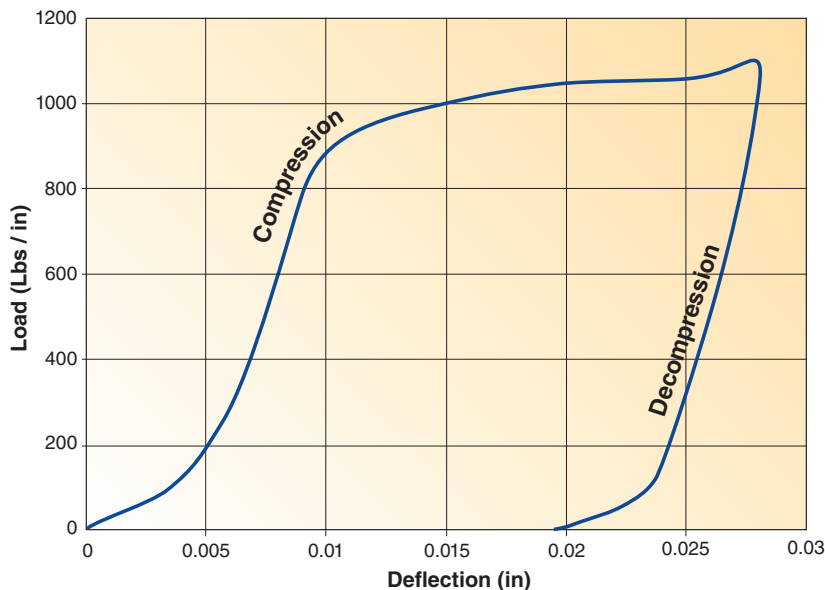

**WARNING**

These products can expose you to chemicals including carbon black (airborne and extracts), antimony trioxide, titanium dioxide, silica (crystalline), di(2-ethylhexyl)phthalate, ethylene thiourea, acrylonitrile, 1,3-butadiene, epichlorohydrin, toluene diisocyanate, tetrafluoroethylene, ethylbenzene, formaldehyde, furfuryl alcohol, glass fibers, methyl isobutyl ketone, nickel (metallic and compounds), lead and lead compounds which are known to the state of California to cause cancer; and 1,3-butadiene, epichlorohydrin, di(2-ethylhexyl)phthalate, di-isodecyl phthalate, ethylene thiourea, methyl isobutyl ketone, methanol, toluene, lead and lead compounds which are known to the state of California to cause birth defects and other reproductive harm. For more information go to [www.P65Warnings.ca.gov](http://www.P65Warnings.ca.gov).

Metal Wire Ring Performance							
Nominal Cross Section	Free Height	Cross Section Code	Temper Code	Material	Seating Load (pounds per inch circum.)	Springback (inches)	Working Pressure Rating (psi)
1/32	0.035	03	-4	Silver/Gold	900	0	7500
				Aluminum	1000	0	7500
				Copper	2400	0	15000
				Nickel	3000	0	20000
				304 Stainless Steel	4200	0	20000
1/16	0.062	05	-4	Silver/Gold	1200	0.0005	7500
				Aluminum	1400	0	7500
				Copper	3400	0	15000
				Nickel	4200	0	20000
				304 Stainless Steel	6000	0.0005	20000
3/32	0.094	06	-4	Silver/Gold	1200	0.001	7500
				Aluminum	1400	0.0005	7500
				Copper	3400	0.0005	15000
				Nickel	4200	0.0005	20000
				304 Stainless Steel	6000	0.001	20000
1/8	0.125	07	-4	Silver/Gold	1200	0.002	7500
				Aluminum	1400	0.001	7500
				Copper	3400	0.001	15000
				Nickel	4200	0.001	20000
				304 Stainless Steel	6000	0.002	20000

Based on nominal seal dimensions, recommended cavity dimensions and ambient temperature. If working pressures exceed the above ratings consult Parker for recommendations. Refer to Page E-68 for a definition of the above performance terminology.

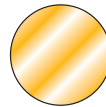

### EWE Metal E-Ring Performance

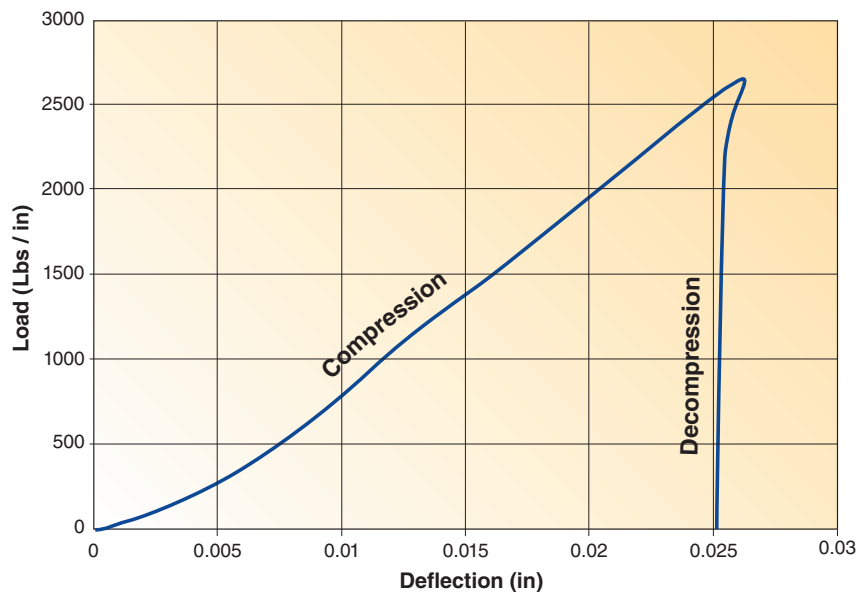

**WARNING**

These products can expose you to chemicals including carbon black (airborne and extracts), antimony trioxide, titanium dioxide, silica (crystalline), di(2-ethylhexyl)phthalate, ethylene thiourea, acrylonitrile, 1,3-butadiene, epichlorohydrin, toluene diisocyanate, tetrafluoroethylene, ethylbenzene, formaldehyde, furfuryl alcohol, glass fibers, methyl isobutyl ketone, nickel (metallic and compounds), lead and lead compounds which are known to the state of California to cause cancer; and 1,3-butadiene, epichlorohydrin, di(2-ethylhexyl)phthalate, di-isodecyl phthalate, ethylene thiourea, methyl isobutyl ketone, methanol, toluene, lead and lead compounds which are known to the state of California to cause birth defects and other reproductive harm. For more information go to [www.P65Warnings.ca.gov](http://www.P65Warnings.ca.gov).



# Leak Rate Information

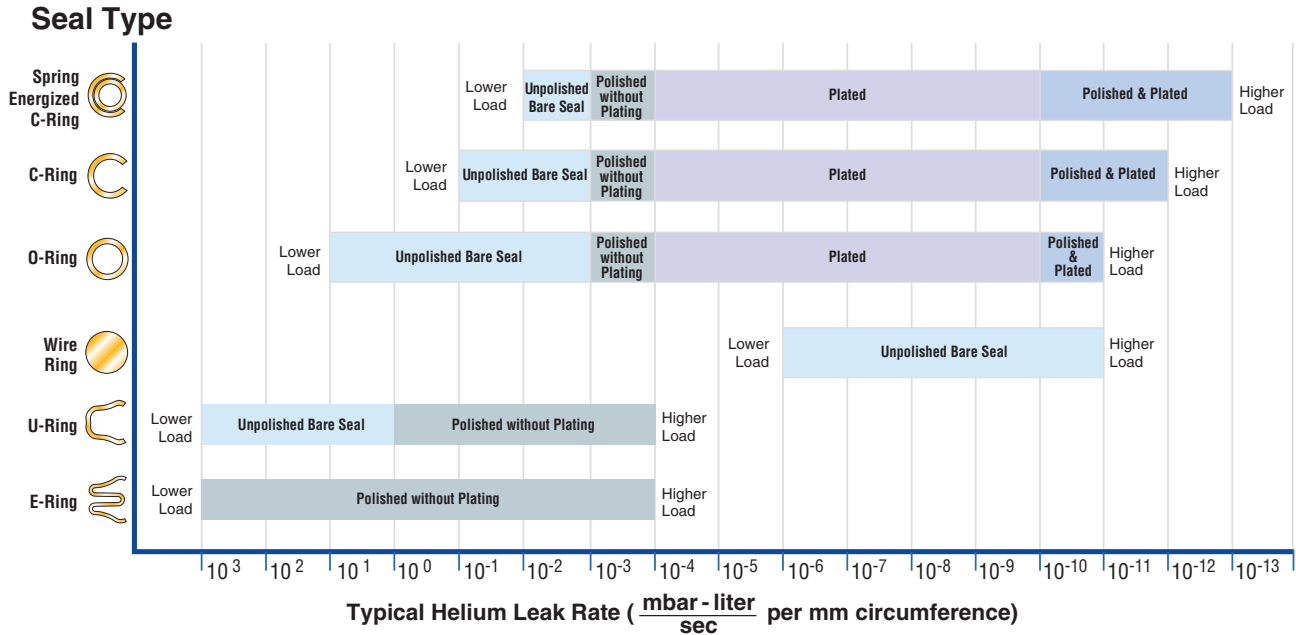

Equivalent leak rates for other gases: Multiply the helium leakage rate by the following factors to obtain the leakage rate of the following gases.

**Oxygen: 0.35**

**Nitrogen: 0.37**

**Hydrogen: 1.42**

**Air: 0.37**

The graph above shows typical ranges of leakage rates that may be expected with various types of seals. Testing was performed using helium mass-spectroscopy leakage detection. A standardized condition of 1 atmosphere differential pressure at 70°F was used in all cases. Test procedures and installation parameters were in accordance with the recommendations given in this design guide including a surface roughness of 16-32 μ inch R<sub>a</sub>.

The widths of the horizontal bars indicate the spread of leakage values that may be expected depending on the specific plating selection and surface condition. (It should be noted that these results are not directly applicable to liquids, since the much higher viscosities and surface tension will generally prevent leakage entirely).

As a service to our customers, we are pleased to offer specific seal performance testing and analysis for unusually challenging and “mission critical” applications. Testing can be set up to reproduce the actual conditions expected in service. Please contact your local Parker representative.

Leak Rate Equivalents					
cc/sec	mbar – liter/sec	Torr – liter/sec	Pa – m <sup>3</sup> /sec	Approximate Equivalent	Approximate 1mm <sup>3</sup> Bubble Equivalent
1	1.01	7.6x10 <sup>-1</sup>	1.01x10 <sup>-1</sup>	2x10 <sup>-3</sup> SCFM	Steady Stream
1x10 <sup>-1</sup>	1.01x10 <sup>-1</sup>	7.6x10 <sup>-2</sup>	1.01x10 <sup>-2</sup>	1 cc every 10 seconds	Steady Stream
1x10 <sup>-2</sup>	1.01x10 <sup>-2</sup>	7.6x10 <sup>-3</sup>	1.01x10 <sup>-3</sup>	1 cc every 100 seconds	10 per second
1x10 <sup>-3</sup>	1.01x10 <sup>-3</sup>	7.6x10 <sup>-4</sup>	1.01x10 <sup>-4</sup>	3 cc per hour	1 per second
1x10 <sup>-4</sup>	1.01x10 <sup>-4</sup>	7.6x10 <sup>-5</sup>	1.01x10 <sup>-5</sup>	1 cc every 3 hours	1 every 10 seconds
1x10 <sup>-5</sup>	1.01x10 <sup>-5</sup>	7.6x10 <sup>-6</sup>	1.01x10 <sup>-6</sup>	1 cc every 24 hours	1 every 100 seconds
1x10 <sup>-6</sup>	1.01x10 <sup>-6</sup>	7.6x10 <sup>-7</sup>	1.01x10 <sup>-7</sup>	1 cc every 2 weeks	3 per hour
1x10 <sup>-7</sup>	1.01x10 <sup>-7</sup>	7.6x10 <sup>-8</sup>	1.01x10 <sup>-8</sup>	3 cc per year	Bubbles too infrequent to observe
1x10 <sup>-8</sup>	1.01x10 <sup>-8</sup>	7.6x10 <sup>-9</sup>	1.01x10 <sup>-9</sup>	1 cc every 3 years	
1x10 <sup>-9</sup>	1.01x10 <sup>-9</sup>	7.6x10 <sup>-10</sup>	1.01x10 <sup>-10</sup>	1 cc every 30 years	
1x10 <sup>-10</sup>	1.01x10 <sup>-10</sup>	7.6x10 <sup>-11</sup>	1.01x10 <sup>-11</sup>	1 cc every 300 years	
1x10 <sup>-11</sup>	1.01x10 <sup>-11</sup>	7.6x10 <sup>-12</sup>	1.01x10 <sup>-12</sup>	1 cc every 3000 years	

**WARNING**

These products can expose you to chemicals including carbon black (airborne and extracts), antimony trioxide, titanium dioxide, silica (crystalline), di(2-ethylhexyl)phthalate, ethylene thiourea, acrylonitrile, 1,3-butadiene, epichlorohydrin, toluene diisocyanate, tetrafluoroethylene, ethylbenzene, formaldehyde, furfuryl alcohol, glass fibers, methyl isobutyl ketone, nickel (metallic and compounds), lead and lead compounds which are known to the state of California to cause cancer; and 1,3-butadiene, epichlorohydrin, di(2-ethylhexyl)phthalate, di-isodecyl phthalate, ethylene thiourea, methyl isobutyl ketone, methanol, toluene, lead and lead compounds which are known to the state of California to cause birth defects and other reproductive harm. For more information go to [www.P65Warnings.ca.gov](http://www.P65Warnings.ca.gov).

# Fatigue and Stress Relaxation

## Fatigue

Fatigue is the main failure mechanism in a material that is subjected to fluctuating loads. Under cyclic loading, localized slip bands can form in regions of high localized stresses. As fluctuating loading continues, these bands increase in number and small microscopic cracks form. Given enough time and stress amplitude, the cracks will grow and propagate through the wall of the seal resulting in a fatigue failure and leakage.

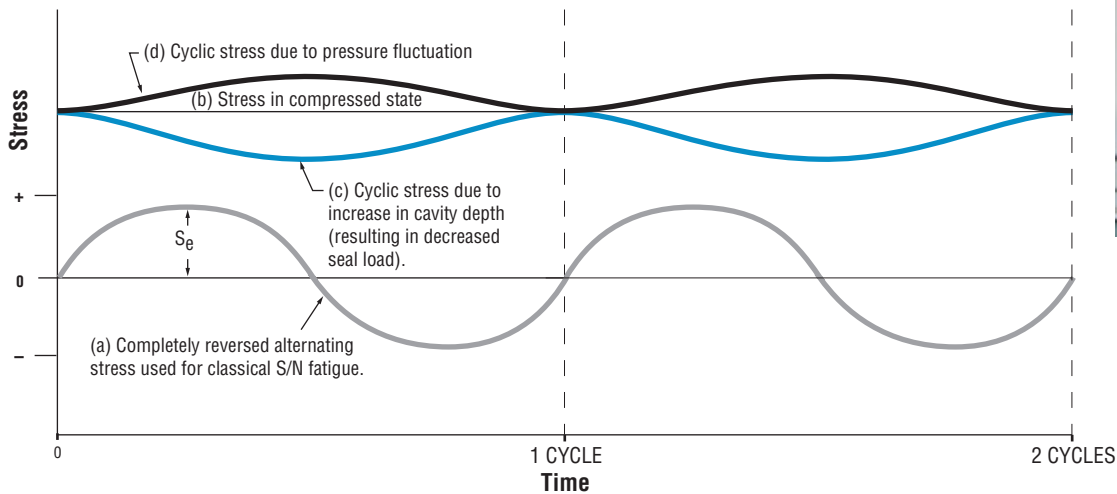

There are several types of loading that can result in fatigue failure, the most common type being alternating tension and compression or reversed loading. Loading of this type is illustrated in line (a) in the figure above, and is the type used in fatigue testing to develop the endurance or fatigue limits ( $S_e$ ) of materials. The endurance limit is the stress below which fatigue failure will not occur, regardless of the number of applied cycles (generally considered  $10^7$  cycles).

Another type of loading results in stresses modulating from one magnitude to another, in the same direction (low to high tensile stress). This is the type of loading most commonly seen in resilient metal seals. Referring to the figure, the seal is deflected or compressed at installation to a stress level corresponding to line (b). If the seal is then exposed to fluctuating flange separation or cavity growth, the stresses in the seal decrease, then increase as illustrated in line (c). If the seal is subjected to pressure cycling, the stresses in the seal can increase beyond the assembly stresses as illustrated in line (d).

Seals designed for greater springback are more resistant to fatigue due to a combination of cross sectional geometry and material properties including temper.

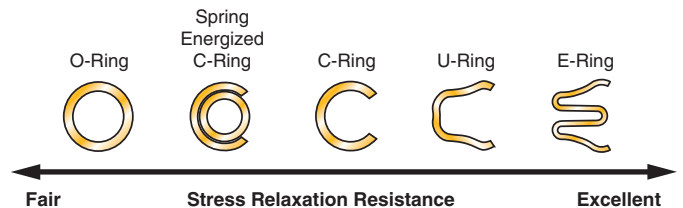

## Stress Relaxation

Any highly stressed component, held at high temperatures, is subject to a form of permanent deformation known as stress relaxation. Unlike creep, stress relaxation occurs in a relatively short period of time, typically in as little as 100 hours of exposure time. This is an important design consideration in any critical sealing application at elevated temperature. Stress relaxation compromises both the sealing load and springback properties of the seal, impacting its ability to maintain sealing integrity under both static and dynamic conditions.

Parker Hannifin has extensive experience designing and testing seals to combat the negative effects of stress relaxation. Our seals are designed to optimize resistance to stress relaxation through careful consideration of geometry, materials and appropriate heat treatment.

### WARNING

These products can expose you to chemicals including carbon black (airborne and extracts), antimony trioxide, titanium dioxide, silica (crystalline), di(2-ethylhexyl)phthalate, ethylene thiourea, acrylonitrile, 1,3-butadiene, epichlorohydrin, toluene diisocyanate, tetrafluoroethylene, ethylbenzene, formaldehyde, furfuryl alcohol, glass fibers, methyl isobutyl ketone, nickel (metallic and compounds), lead and lead compounds which are known to the state of California to cause cancer; and 1,3-butadiene, epichlorohydrin, di(2-ethylhexyl)phthalate, di-isodecyl phthalate, ethylene thiourea, methyl isobutyl ketone, methanol, toluene, lead and lead compounds which are known to the state of California to cause birth defects and other reproductive harm. For more information go to [www.P65Warnings.ca.gov](http://www.P65Warnings.ca.gov).



## Installation Guidelines

In addition to the required cavity dimensions provided in Section C, there are other important cavity design issues which affect seal performance.

Application/Medium Being Sealed	Surface Roughness, $R_a$	
	$\mu$ inch	$\mu$ m
Dynamic Axial Seal	4 – 8	0,1 – 0,2
Vacuum Applications	8 – 16	0,2 – 0,4
Helium Gas Hydrogen Gas Freon	8 – 16	0,2 – 0,4
Air Nitrogen Gas Argon Natural Gas Fuel (aircraft and automotive)	16 – 32	0,4 – 0,8
Water Hydraulic Oil Crude Oil Sealants	16 – 63	0,4 – 1,6

### Surface Roughness Recommendations

The roughness of the mating surfaces directly affects the leak rate when using unplated seals. Selecting high load seals with appropriate plating can substantially offset the affects of rough finishes; however, the guidelines in the table, left should be followed whenever possible. We also recommend a turned finish with a circular lay. This is always preferable to a random or radial lay. Discontinuities, radial scratches or pits may be blended, subject to the flatness recommendations given below.

Surfaces with a smoother finish than recommended may actually impair sealing. With the optimum surface roughness and circular lay, the finish embeds within the seal surface. Each ridge of the surface roughness acts as a stress riser and as an independent, redundant sealing line.







To select the appropriate plating or coating material and thickness refer to Page D-60 in the metal seal material selection section.

### Surface Flatness Recommendations

Metal seals can accommodate some degree of waviness, or lack of flatness of the mating surfaces. Spring energized seals offer the greatest amount of compliance since each coil of the spring acts as an independent force to assist the jacket in conforming to the mating surface.

Specific surface flatness recommendations:

- Maximum waviness of the cavity mating surfaces must be within the limits given in the table below.
- The sum of the flatness tolerances of the opposing mating surfaces shall not exceed 4% of the seal free height.
- The cavity depth limits provided in Section C shall not be exceeded.

Maximum Waviness of Cavity Mating Surfaces						
Seal Free Height						
	C-Ring	E-Ring	O-Ring	U-Ring	Wire Ring	Spring Energized C-Ring
Maximum Gradient						
Less than 0.108 inch	0.002	0.004	0.001	0.002	0.001	0.003
Greater than or equal to 0.108 inch	0.004	0.007	0.002	0.004	0.002	0.005

#### ⚠ WARNING

These products can expose you to chemicals including carbon black (airborne and extracts), antimony trioxide, titanium dioxide, silica (crystalline), di(2-ethylhexyl)phthalate, ethylene thiourea, acrylonitrile, 1,3-butadiene, epichlorohydrin, toluene diisocyanate, tetrafluoroethylene, ethylbenzene, formaldehyde, furfuryl alcohol, glass fibers, methyl isobutyl ketone, nickel (metallic and compounds), lead and lead compounds which are known to the state of California to cause cancer; and 1,3-butadiene, epichlorohydrin, di(2-ethylhexyl)phthalate, di-isodecyl phthalate, ethylene thiourea, methyl isobutyl ketone, methanol, toluene, lead and lead compounds which are known to the state of California to cause birth defects and other reproductive harm. For more information go to [www.P65Warnings.ca.gov](http://www.P65Warnings.ca.gov).



## Surface Hardness Recommendations

Many metal seals are designed to produce high seating loads against the mating surfaces to meet ultra low leakage requirements. To withstand these high compressive stresses, without

damage to the sealing surfaces, requires these surfaces to have a hardness of at least 35 Rc. This is particularly important when the seal seating load exceeds 200 lb/inch (35 N/mm) of circumference. Dynamic axial seals require a hardness of at least 60 Rc.

## Compression Limiters

Section C provides the required cavity depths for each type of metal seal. Using the specified groove depths results in optimal seal compression with the proper seating load and excellent resiliency. Excessive compression can actually reduce sealing stress by creating an excessively broad, or even double footprint.

Additionally, the seal may be crushed so that normal springback cannot occur. Equally, under-compression must also be avoided, since it results in low sealing stresses and potential leakage. When it is not possible or practical to machine the required hardware cavity or cavity depth, a compression limiter may be used. Two types of limiters are available:

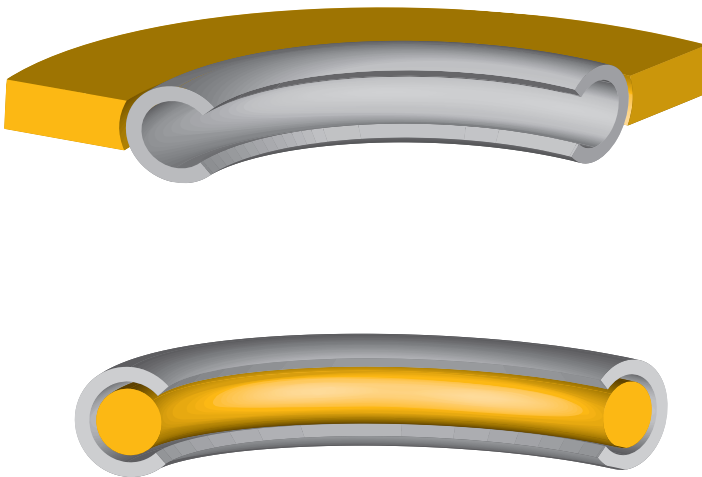

### External Limiter:

The external limiter is a metal plate manufactured to a thickness corresponding to the required working height of the seal. This is the preferred type of compression limiter. It is designed with a large surface area which does not compress even under the highest of compressive loads thus always ensuring proper seal compression. This type of limiter also supports the seal against hoop stresses from internal pressures as well as providing convenient centering within a bolt circle. External limiters are available with a relieved inside diameter which allows the seal to snap into the limiter resulting in a convenient one piece assembly.

### Internal Limiter:

A solid wire installed within the seal serves as an internal limiter and prevents over-compression of the seal. This method is available with all C-Rings, O-Rings, and Spring Energized C-Rings. Because the wire will also compress under high loads, seal compression with this method may not be as consistent as with the external limiter. Seating loads over 1000 lb/inch (175 N/mm) of circumference may result in excessive compression of the seal and reduced seal performance. The internal limiter also offers no support to the seal against pressure induced hoop stresses and will require a groove for high pressure applications.

## Availability of Limiters

External and Internal limiters can be custom designed for all applications. Contact Parker for more information.

### ⚠ WARNING

These products can expose you to chemicals including carbon black (airborne and extracts), antimony trioxide, titanium dioxide, silica (crystalline), di(2-ethylhexyl)phthalate, ethylene thiourea, acrylonitrile, 1,3-butadiene, epichlorohydrin, toluene diisocyanate, tetrafluoroethylene, ethylbenzene, formaldehyde, furfuryl alcohol, glass fibers, methyl isobutyl ketone, nickel (metallic and compounds), lead and lead compounds which are known to the state of California to cause cancer; and 1,3-butadiene, epichlorohydrin, di(2-ethylhexyl)phthalate, di-isodecyl phthalate, ethylene thiourea, methyl isobutyl ketone, methanol, toluene, lead and lead compounds which are known to the state of California to cause birth defects and other reproductive harm. For more information go to [www.P65Warnings.ca.gov](http://www.P65Warnings.ca.gov).



## Installation Guidelines

### Bolt Load & Tightening Torque Guidelines

The metal seal seating load, or load required to compress the seal, is typically achieved by tightening a number of bolts spaced around the flange. The number, size, and grade of these bolts must be sufficient to compress the seal during installation and withstand the system operating pressure which acts upon the surface of the flange.

*Note: These bolt load and tightening torque guidelines are not intended to be used as design criteria and are only offered as a general guide. Many other factors such as flange thickness, flange rotation, thermal cycling, bolt stress relaxation, externally applied loads, temperature derating, impulse and fatigue, etc., must be considered by the design engineer to ensure proper bolt and torque selection.*

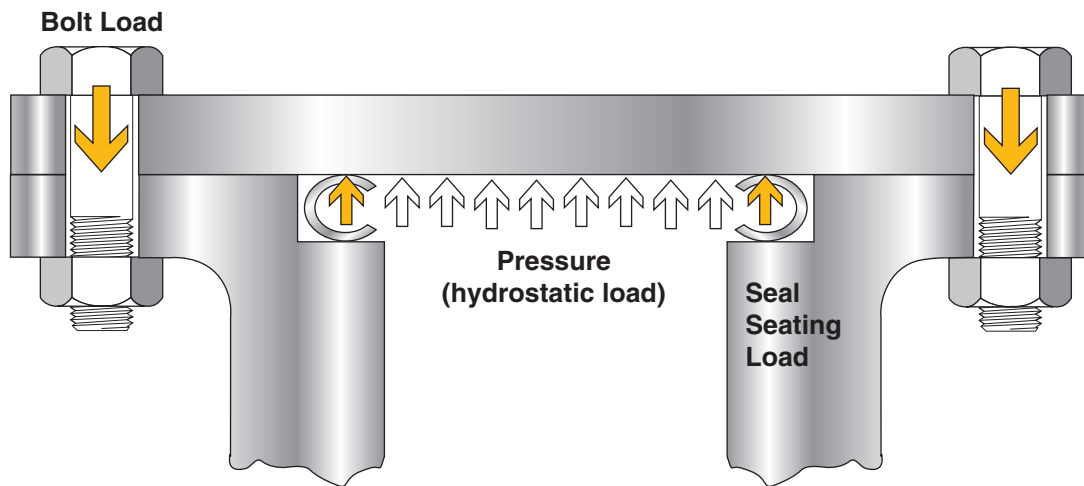

**Bolt Load Required  $\geq$  Hydrostatic Load + Seal Seating Load + Safety Margin**



The equation below provides the tightening torque required to produce a bolt load for various bolt geometries.

$$T = Lr_t \left( \frac{\cos\theta_n \tan\alpha + \mu_1}{\cos\theta_n - \mu_1 \tan\alpha} + \frac{r_c}{r_t} \mu_2 \right)$$

Where:  $T$  = torque applied to the bolt, in-lb

$L$  = bolt load, lb

$r_t$  = bolt pitch radius, inches

$r_c$  = mean bearing circle radius, inches

$\theta_n$  = angle from bolt axis to force component normal component normal to thread surface, degrees

$\alpha$  = bolt helix angle, degrees

$\mu_1$  = thread coefficient of friction

$\mu_2$  = bearing circle coefficient of friction

#### ⚠ WARNING

These products can expose you to chemicals including carbon black (airborne and extracts), antimony trioxide, titanium dioxide, silica (crystalline), di(2-ethylhexyl)phthalate, ethylene thiourea, acrylonitrile, 1,3-butadiene, epichlorohydrin, toluene diisocyanate, tetrafluoroethylene, ethylbenzene, formaldehyde, furfuryl alcohol, glass fibers, methyl isobutyl ketone, nickel (metallic and compounds), lead and lead compounds which are known to the state of California to cause cancer; and 1,3-butadiene, epichlorohydrin, di(2-ethylhexyl)phthalate, di-isodecyl phthalate, ethylene thiourea, methyl isobutyl ketone, methanol, toluene, lead and lead compounds which are known to the state of California to cause birth defects and other reproductive harm. For more information go to [www.P65Warnings.ca.gov](http://www.P65Warnings.ca.gov).

The table below was generated from the equation on the previous page for Unified and American National threads. This table can be used as a guideline for estimating the bolt load and tightening torque requirements.

**Seal Seating Load:**

- Step 1: Obtain the seal seating load (lb/inch circumference) from the tables on pages C-16 through C-39.
- Step 2: Multiply the seating load by the seal circumference to obtain the total seal seating load (lb).

**Hydrostatic Load:**

- Step 3: Calculate the differential area:  $(\pi/4) \cdot (\text{Seal O.D.})^2$
- Step 4: Multiply the pressure (psi) by the differential area to obtain the hydrostatic load (lb).

**Number of Bolts required:**

- Step 5: Total clamping load = seal seating load + hydrostatic load.
- Step 6: Divide total clamping load by the maximum clamping load for the chosen bolt size from the table to obtain the number of bolts required.

**Apply suitable safety and design margin:**

- Step 7: The design engineer must consider other influences such as elevated temperatures and pressure impulses. A sufficient safety margin should be applied when determining the required number of bolts in order to meet Code or other design requirements.

Size	Bolt O.D. (in)	Bolt Stress Area (sq. in.)	SAE Grade 2 Bolts			SAE Grade 5 Bolts			SAE Grade 7 Bolts			SAE Grade 8 Bolts		
			Maximum Bolt Clamping Load (lb)	Torque Dry (in-lb)	Torque Lubricated (in-lb)	Maximum Bolt Clamping Load (lb)	Torque Dry (in-lb)	Torque Lubricated (in-lb)	Maximum Bolt Clamping Load (lb)	Torque Dry (in-lb)	Torque Lubricated (in-lb)	Maximum Bolt Clamping Load (lb)	Torque Dry (in-lb)	Torque Lubricated (in-lb)
4 - 40	0.1120	0.0060	260	6	5	410	10	7	500	12	9	580	14	10
4 - 48	0.1120	0.0066	290	7	5	450	11	8	550	13	10	630	15	11
6 - 32	0.1250	0.0091	400	11	8	620	18	12	760	22	15	870	25	17
6 - 40	0.1250	0.0102	450	12	8	690	19	13	860	24	16	980	27	18
8 - 32	0.1640	0.0140	620	22	16	950	34	24	1180	42	30	1340	48	34
8 - 36	0.1640	0.0147	650	23	16	1000	35	25	1230	43	31	1410	49	35
10 - 24	0.1900	0.0175	770	33	23	1190	50	36	1470	62	45	1680	71	51
10 - 32	0.1900	0.0200	880	36	26	1360	56	39	1680	69	49	1920	79	56
1/4 - 20	0.2500	0.0318	1400	74	53	2160	110	82	2670	140	100	3050	160	120
1/4 - 28	0.2500	0.0364	1600	82	58	2480	130	89	3060	160	110	3490	180	130
5/16 - 18	0.3125	0.0524	2310	150	100	3560	230	160	4400	280	200	5030	320	230
5/16 - 24	0.3125	0.0580	2550	160	110	3940	240	170	4870	300	210	5570	350	240
3/8 - 16	0.3750	0.0775	3410	250	180	5270	390	280	6510	480	340	7440	550	390
3/8 - 24	0.3750	0.0878	3860	280	190	5970	430	300	7380	530	370	8430	610	420
7/16 - 14	0.4375	0.1063	4680	410	290	7230	640	450	8930	780	560	10200	900	640
7/16 - 20	0.4375	0.1187	5220	450	310	8070	690	480	9970	850	590	11400	980	680
1/2 - 13	0.5000	0.1419	6240	620	440	9650	950	670	11900	1170	830	13600	1340	950
1/2 - 20	0.5000	0.1599	7040	670	470	10900	1040	720	13400	1280	890	15400	1470	1020
9/16 - 12	0.5625	0.1820	7570	850	600	12400	1390	980	15300	1710	1210	17500	1950	1380
9/16 - 18	0.5625	0.2030	8440	920	640	13800	1500	1040	17100	1860	1290	19500	2120	1470
5/8 - 11	0.6250	0.2260	9400	1150	810	15400	1890	1330	19000	2330	1640	21700	2660	1880
5/8 - 18	0.6250	0.2560	10600	1260	870	17400	2070	1430	21500	2550	1760	24600	2920	2020
3/4 - 10	0.7500	0.3340	13900	2030	1430	22700	3320	2330	28100	4110	2880	32100	4690	3290
3/4 - 16	0.7500	0.3730	15500	2200	1520	25400	3610	2490	31300	4450	3070	35800	5090	3510
7/8 - 9	0.8750	0.4620	10300	1750	1230	28800	4890	3430	38800	6590	4620	44400	7540	5290
7/8 - 14	0.8750	0.5090	11400	1890	1300	31800	5260	3630	42800	7080	4880	48900	8090	5580
1 - 8	1.0000	0.6060	13600	2640	1850	37800	7330	5130	50900	9870	6910	58200	11290	7900
1 - 12	1.0000	0.6630	14900	2820	1950	41400	7840	5410	55700	10550	7270	63600	12040	8310
11/8 - 7	1.1250	0.7630	17100	3740	2620	45200	9870	6920	64100	14000	9810	73200	15990	11200
11/8 - 12	1.1250	0.8560	19200	4070	2800	50700	10750	7380	71900	15240	10470	82200	17420	11970
11/4 - 7	1.2500	0.9690	21700	5230	3650	57400	13830	9650	81400	19610	13680	93000	22410	15630
11/4 - 12	1.2500	1.0730	24000	5630	3860	63500	14890	10200	90100	21120	14470	10300	24150	16550
13/8 - 6	1.3750	1.1550	25900	6890	4820	68400	18200	12730	97000	25810	18050	110900	29510	20630
13/8 - 12	1.3750	1.3150	29500	7580	5180	77800	19990	13670	110500	28400	19410	126200	32430	22170
11/2 - 6	1.5000	1.4050	31500	9090	6330	83200	24020	16730	118000	34060	23730	134900	38940	27130
11/2 - 12	1.5000	1.5810	35400	9900	6750	93600	26160	17850	132800	37120	25320	151800	42430	28950

Maximum bolt clamping load is a recommended maximum and is 80% of the bolt proof load. Sizes 1/4 to 1-1/2 are in accordance with ANSI B18.2.1-1981 for standard hex bolts. Sizes 4 to 10 are in accordance with ANSI B18.6.3-1972 for hex head machine screws. Dry torque assumes  $\mu_1 = \mu_2 = 0.15$ . Lubricated torque assumes  $\mu_1 = \mu_2 = 0.10$ .

**WARNING**

These products can expose you to chemicals including carbon black (airborne and extracts), antimony trioxide, titanium dioxide, silica (crystalline), di(2-ethylhexyl)phthalate, ethylene thiourea, acrylonitrile, 1,3-butadiene, epichlorohydrin, toluene diisocyanate, tetrafluoroethylene, ethylbenzene, formaldehyde, furfuryl alcohol, glass fibers, methyl isobutyl ketone, nickel (metallic and compounds), lead and lead compounds which are known to the state of California to cause cancer; and 1,3-butadiene, epichlorohydrin, di(2-ethylhexyl)phthalate, di-isodecyl phthalate, ethylene thiourea, methyl isobutyl ketone, methanol, toluene, lead and lead compounds which are known to the state of California to cause birth defects and other reproductive harm. For more information go to [www.P65Warnings.ca.gov](http://www.P65Warnings.ca.gov).



## Seal Shaping Requirements for Non-Circular Seals

All standard metal seals can be formed into various shapes. The illustration below shows some of the many shapes in which metal seals can be made.

For applications as varied as fuel nozzle mounting flanges on aircraft gas turbine engines, or dies for extrusion of plastic film, the availability of specially shaped metal seals offers the greatest design flexibility.

The table (below) provides the minimum outer corner radius for the various cross sections of metal C-rings, O-rings, spring energized C-rings, wire rings, E-rings and U-rings. All shaped seals are custom designed by our engineers. Please send us your completed "application data sheet" provided on pages F-103 and F-104 of this design guide including a sketch of the non-circular cavity and we will assist you in determining the best seal type and shape for your application.

Minimum Inside Bend Radius of Seal (inches)						
Cross Section Code	C-Ring	E-Ring	O-Ring	U-Ring	Spring Energized C-Ring	Wire Ring
01	0.20		0.40			
02	0.20		0.60			
03	0.20		0.60			0.40
04	0.20		0.90			
05	0.30	0.70	0.90	0.70	0.40	0.60
06	0.30	0.90	1.30			
07	0.50	1.50	1.30	1.00	0.60	0.90
08	0.50	0.90	0.40			
09	0.60	1.90	0.60	1.30	0.80	1.30
10	0.60	1.20	0.80			
11	0.80	1.20	1.60		0.90	
12	0.80		0.90			
13	0.90	1.90	1.90	2.00	1.10	
14	0.90		1.10			
15	1.20	2.70	2.50	2.60	1.50	
16	1.20		1.50			
17	1.80		3.80		2.30	
18	1.80		2.30			
19	2.40		5.00		3.00	
20	2.40		3.00			
21			6.30			
25			1.30			
29			0.50			
31			0.60			
32			0.90			

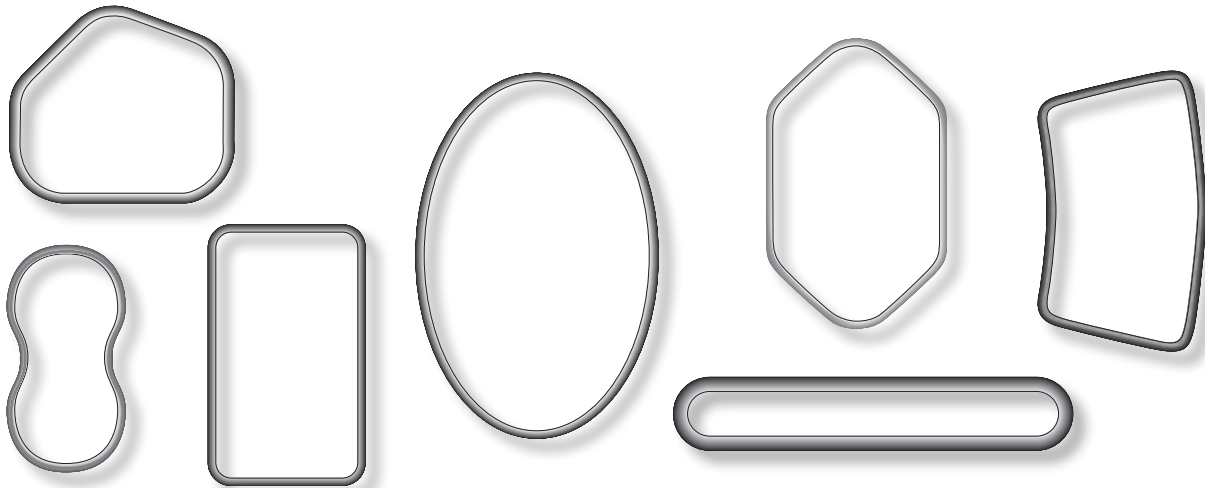

**⚠ WARNING**

These products can expose you to chemicals including carbon black (airborne and extracts), antimony trioxide, titanium dioxide, silica (crystalline), di(2-ethylhexyl)phthalate, ethylene thiourea, acrylonitrile, 1,3-butadiene, epichlorohydrin, toluene diisocyanate, tetrafluoroethylene, ethylbenzene, formaldehyde, furfuryl alcohol, glass fibers, methyl isobutyl ketone, nickel (metallic and compounds), lead and lead compounds which are known to the state of California to cause cancer; and 1,3-butadiene, epichlorohydrin, di(2-ethylhexyl)phthalate, di-isodecyl phthalate, ethylene thiourea, methyl isobutyl ketone, methanol, toluene, lead and lead compounds which are known to the state of California to cause birth defects and other reproductive harm. For more information go to [www.P65Warnings.ca.gov](http://www.P65Warnings.ca.gov).

# Metal Seal Manufacturing Specifications

The table below provides the allowable roundness and flatness for standard metal seals: C-rings, E-rings, O-rings, U-rings, wire rings, spring energized C-rings, and spring energized O-rings in an unrestrained state. When restrained, the seal diameter shall be within the limits specified in Section C.

## Definition of Roundness

Difference between the largest measured reading and the lowest measured reading.

Metal Seal Roundness & Flatness	
Seal Diameter Range (inches)	Roundness & Flatness (inches)
0.180 - 1.000	0.020
1.001 - 2.500	0.030
2.501 - 5.000	0.060
5.001 - 10.000	0.090
10.001 - 12.000	0.125
12.001 - 14.000	0.150
14.001 - 16.000	0.175
16.001 - 18.000	0.200
18.001 - 22.000	0.250
22.001 - 36.000	0.500

## Metal Seal Surface Finish

All unplated and plated metal seals are produced with a 16 μ inch R<sub>a</sub> surface finish.

## Metal O-Ring Weld Finishing

The Metal O-Ring weld process results in a weld fillet which is finished and smoothed to the adjacent surfaces. The surface at the blend area shall not be more than 0.002 inch below the adjacent surfaces.

### WARNING

These products can expose you to chemicals including carbon black (airborne and extracts), antimony trioxide, titanium dioxide, silica (crystalline), di(2-ethylhexyl)phthalate, ethylene thiourea, acrylonitrile, 1,3-butadiene, epichlorohydrin, toluene diisocyanate, tetrafluoroethylene, ethylbenzene, formaldehyde, furfuryl alcohol, glass fibers, methyl isobutyl ketone, nickel (metallic and compounds), lead and lead compounds which are known to the state of California to cause cancer; and 1,3-butadiene, epichlorohydrin, di(2-ethylhexyl)phthalate, di-isodecyl phthalate, ethylene thiourea, methyl isobutyl ketone, methanol, toluene, lead and lead compounds which are known to the state of California to cause birth defects and other reproductive harm. For more information go to [www.P65Warnings.ca.gov](http://www.P65Warnings.ca.gov).



# Preferred C-Ring Sizes Internal Pressure Face Seal

Parker C-rings and spring energized C-rings are available in a virtually unlimited number of sizes. Each uniquely sized seal is produced with tooling specifically made for that size. Choosing

one of the diameters listed below typically will result in a cost saving and reduced delivery times. The following is a list of the preferred C-ring and spring energized C-ring sizes.

Preferred C-Ring Sizes Internal Pressure Face Seal												
Seal Type	Free Height	Cross Section Code	Preferred Seal Diameters (all dimensions are in inches)									
			ECI	0.094	01 & 02	0.150	0.240	0.269	0.319	0.406	0.458	0.535
0.185	0.255	0.287				0.322	0.412	0.465	0.543	0.695	0.785	0.961
0.212	0.257	0.303				0.325	0.416	0.494	0.577	0.724	0.796	0.996
0.216	0.259	0.304				0.327	0.432	0.506	0.580	0.748	0.817	1.034
0.221	0.260	0.312				0.339	0.445	0.508	0.609	0.762	0.849	
			0.236	0.261	0.314	0.382	0.448	0.529	0.634	0.770	0.906	
ECI	0.094	01 & 02	0.310	0.413	0.573	0.721	0.886	0.950	1.205	1.550	1.959	4.467
			0.333	0.433	0.589	0.787	0.910	0.975	1.222	1.614	2.300	4.800
			0.344	0.437	0.631	0.808	0.912	1.004	1.282	1.637	2.309	
			0.352	0.444	0.659	0.812	0.926	1.005	1.369	1.642	2.802	
			0.378	0.451	0.670	0.819	0.930	1.138	1.378	1.689	3.427	
			0.381	0.481	0.694	0.843	0.946	1.142	1.519	1.911	3.890	
ECI	0.062	05 & 06	0.271	0.547	0.765	0.941	1.172	1.417	1.814	2.244	2.957	4.793
			0.309	0.571	0.779	0.949	1.181	1.420	1.816	2.270	2.982	5.144
			0.338	0.578	0.786	0.960	1.187	1.428	1.850	2.327	3.041	5.265
			0.346	0.590	0.787	0.972	1.223	1.442	1.870	2.337	3.071	5.427
			0.356	0.593	0.797	0.974	1.224	1.490	1.878	2.343	3.167	5.434
			0.380	0.601	0.800	0.984	1.238	1.497	1.884	2.380	3.285	5.518
			0.394	0.606	0.819	0.990	1.255	1.549	1.917	2.382	3.386	5.796
			0.397	0.612	0.827	0.993	1.277	1.555	1.926	2.387	3.667	5.799
			0.440	0.627	0.839	0.998	1.281	1.557	1.933	2.425	3.809	5.831
			0.463	0.638	0.850	1.004	1.290	1.566	1.958	2.497	3.841	6.250
			0.483	0.650	0.856	1.024	1.312	1.575	1.968	2.549	3.875	6.442
			0.492	0.669	0.858	1.050	1.320	1.593	1.997	2.560	3.936	6.642
			0.493	0.690	0.865	1.053	1.321	1.594	2.006	2.594	3.986	7.100
			0.498	0.692	0.866	1.062	1.325	1.620	2.059	2.625	3.990	7.367
			0.505	0.693	0.876	1.063	1.328	1.644	2.072	2.647	4.047	7.940
			0.507	0.694	0.878	1.066	1.338	1.648	2.081	2.667	4.185	8.020
			0.509	0.703	0.881	1.097	1.343	1.657	2.115	2.700	4.309	8.995
			0.512	0.709	0.883	1.102	1.346	1.690	2.117	2.717	4.380	10.069
			0.520	0.713	0.885	1.122	1.347	1.718	2.120	2.769	4.444	14.288
			0.525	0.733	0.903	1.128	1.366	1.723	2.150	2.801	4.519	
0.531	0.743	0.916	1.151	1.397	1.757	2.197	2.828	4.537				
0.532	0.750	0.922	1.156	1.406	1.808	2.207	2.895	4.611				
0.533	0.756	0.925	1.166	1.412	1.813	2.225	2.953	4.717				
ECI	0.094	07 & 08	0.374	0.715	0.972	1.210	1.393	1.658	1.883	2.157	2.365	2.694
			0.395	0.739	0.990	1.225	1.399	1.661	1.908	2.187	2.367	2.705
			0.457	0.780	1.021	1.227	1.437	1.666	1.959	2.194	2.371	2.732
			0.462	0.792	1.039	1.232	1.442	1.681	1.965	2.196	2.381	2.734
			0.482	0.801	1.052	1.234	1.464	1.693	1.982	2.234	2.402	2.743
			0.487	0.815	1.062	1.240	1.474	1.737	1.990	2.235	2.444	2.754
			0.489	0.827	1.064	1.248	1.487	1.740	1.991	2.244	2.480	2.765
			0.582	0.864	1.081	1.260	1.492	1.747	1.995	2.256	2.493	2.780
			0.614	0.871	1.083	1.265	1.499	1.777	2.008	2.260	2.506	2.781
			0.619	0.872	1.087	1.272	1.517	1.780	2.037	2.283	2.514	2.802
			0.622	0.895	1.120	1.274	1.552	1.783	2.043	2.296	2.535	2.819
			0.645	0.920	1.133	1.299	1.570	1.802	2.052	2.319	2.569	2.881
			0.652	0.927	1.140	1.302	1.575	1.806	2.107	2.321	2.592	2.913
			0.676	0.930	1.146	1.307	1.593	1.818	2.110	2.323	2.631	2.921
			0.678	0.934	1.168	1.339	1.600	1.825	2.112	2.348	2.638	2.944
			0.683	0.940	1.170	1.356	1.615	1.834	2.122	2.354	2.682	3.110
			0.696	0.953	1.178	1.365	1.618	1.858	2.125	2.362	2.685	3.131
			0.707	0.958	1.201	1.390	1.623	1.865	2.132	2.364	2.687	3.169

**WARNING**

These products can expose you to chemicals including carbon black (airborne and extracts), antimony trioxide, titanium dioxide, silica (crystalline), di(2-ethylhexyl)phthalate, ethylene thiourea, acrylonitrile, 1,3-butadiene, epichlorohydrin, toluene diisocyanate, tetrafluoroethylene, ethylbenzene, formaldehyde, furfuryl alcohol, glass fibers, methyl isobutyl ketone, nickel (metallic and compounds), lead and lead compounds which are known to the state of California to cause cancer; and 1,3-butadiene, epichlorohydrin, di(2-ethylhexyl)phthalate, di-isodecyl phthalate, ethylene thiourea, methyl isobutyl ketone, methanol, toluene, lead and lead compounds which are known to the state of California to cause birth defects and other reproductive harm. For more information go to [www.P65Warnings.ca.gov](http://www.P65Warnings.ca.gov).



Preferred C-Ring Sizes Internal Pressure Face Seal															
Seal Type	Free Height	Cross Section Code	Preferred Seal Diameters (all dimensions are in inches)												
			ECI [cont.]	0.094	07 & 08	3.176	3.472	3.701	4.037	4.452	4.698	4.866	5.131	5.520	6.248
3.188	3.490	3.709				4.170	4.517	4.724	4.870	5.164	5.726	6.310			
3.256	3.506	3.819				4.243	4.520	4.743	4.874	5.243	5.796	6.929			
3.380	3.569	3.947				4.268	4.547	4.764	4.921	5.310	5.821	7.256			
3.381	3.583	3.990				4.327	4.625	4.769	4.987	5.343	5.903	8.000			
3.425	3.587	3.993				4.376	4.693	4.793	5.091	5.368	5.993	8.250			
3.440	3.694	4.033				4.449	4.697	4.835	5.130	5.482	6.050	10.771			
ECI	0.125	09 & 10				0.866	1.598	2.178	2.552	2.927	3.536	4.059	4.842	5.733	6.750
						0.973	1.642	2.189	2.583	2.949	3.592	4.115	4.937	5.750	6.819
						1.036	1.646	2.198	2.598	2.969	3.615	4.125	4.945	5.768	6.877
			1.067	1.650	2.233	2.610	2.983	3.622	4.146	4.950	5.827	7.056			
			1.126	1.721	2.235	2.615	2.986	3.655	4.177	4.952	5.885	7.063			
			1.129	1.725	2.240	2.618	2.992	3.670	4.196	4.973	5.919	7.244			
			1.163	1.756	2.283	2.644	3.015	3.677	4.265	5.015	5.940	7.268			
			1.169	1.786	2.350	2.677	3.032	3.730	4.327	5.062	5.953	7.502			
			1.183	1.800	2.354	2.686	3.052	3.736	4.380	5.075	5.975	7.552			
			1.221	1.824	2.365	2.690	3.055	3.740	4.422	5.088	6.008	7.606			
			1.286	1.848	2.406	2.709	3.115	3.755	4.455	5.089	6.045	7.670			
			1.288	1.855	2.415	2.719	3.169	3.802	4.496	5.095	6.057	7.790			
			1.310	1.872	2.421	2.740	3.177	3.865	4.497	5.140	6.125	7.990			
			1.383	1.900	2.430	2.752	3.243	3.876	4.571	5.157	6.136	8.250			
			1.400	1.914	2.433	2.765	3.253	3.900	4.588	5.195	6.143	9.009			
			1.411	1.969	2.442	2.797	3.260	3.907	4.630	5.231	6.174	9.956			
			1.423	1.975	2.445	2.807	3.325	3.916	4.637	5.380	6.181				
			1.441	1.977	2.478	2.808	3.327	3.927	4.640	5.386	6.242				
			1.454	1.984	2.483	2.831	3.332	3.930	4.716	5.394	6.390				
			1.473	2.047	2.488	2.835	3.363	3.961	4.717	5.400	6.500				
1.482	2.095	2.490	2.865	3.367	3.985	4.720	5.437	6.590							
1.488	2.096	2.495	2.875	3.371	4.032	4.745	5.493	6.598							
1.536	2.161	2.525	2.909	3.462	4.046	4.750	5.620	6.673							
1.571	2.163	2.530	2.913	3.525	4.052	4.757	5.646	6.732							
ECI	0.156	11 & 12	1.278	2.105	2.742	3.040	3.543	4.105	4.492	5.118	5.807	7.048			
			1.475	2.205	2.745	3.062	3.600	4.192	4.562	5.131	5.815	7.217			
			1.585	2.342	2.795	3.130	3.717	4.206	4.615	5.197	5.819	7.313			
			1.737	2.360	2.853	3.246	3.731	4.269	4.715	5.319	5.951	7.740			
			1.773	2.540	2.890	3.290	3.892	4.315	4.798	5.461	5.971	8.375			
			1.827	2.575	2.978	3.390	3.982	4.354	5.018	5.492	6.358				
			2.062	2.694	2.987	3.402	4.034	4.409	5.078	5.502	6.367				
			2.065	2.739	3.039	3.432	4.040	4.479	5.096	5.505	6.890				
ECI	0.188	13 & 14	1.722	3.785	4.112	4.599	5.047	5.677	6.102	6.680	7.265				
			1.985	3.832	4.152	4.644	5.117	5.785	6.257	6.824	7.365				
			2.065	3.840	4.275	4.721	5.168	5.786	6.279	6.865	7.375				
			2.618	4.009	4.282	4.725	5.193	5.813	6.315	6.990	7.486				
			2.733	4.015	4.323	4.865	5.260	5.903	6.320	7.115	7.982				
			2.920	4.073	4.365	4.977	5.354	5.908	6.371	7.181	8.867				
			3.239	4.082	4.439	4.982	5.394	5.911	6.578	7.188	9.251				
			3.618	4.090	4.490	5.037	5.504	6.019	6.584	7.215	10.375				
ECI	0.250	15 & 16	3.915	4.713	4.896	5.224	5.455	5.735	6.580						
			4.700	4.867	5.106	5.402	5.672	6.027	8.410						
ECI	0.375	17 & 18	5.969												

**WARNING**

These products can expose you to chemicals including carbon black (airborne and extracts), antimony trioxide, titanium dioxide, silica (crystalline), di(2-ethylhexyl)phthalate, ethylene thiourea, acrylonitrile, 1,3-butadiene, epichlorohydrin, toluene diisocyanate, tetrafluoroethylene, ethylbenzene, formaldehyde, furfuryl alcohol, glass fibers, methyl isobutyl ketone, nickel (metallic and compounds), lead and lead compounds which are known to the state of California to cause cancer; and 1,3-butadiene, epichlorohydrin, di(2-ethylhexyl)phthalate, di-isodecyl phthalate, ethylene thiourea, methyl isobutyl ketone, methanol, toluene, lead and lead compounds which are known to the state of California to cause birth defects and other reproductive harm. For more information go to [www.P65Warnings.ca.gov](http://www.P65Warnings.ca.gov).



## Preferred C-Ring Sizes Internal Pressure Face Seal

Preferred Spring Energized C-Ring Sizes Internal Pressure Face Seal													
Seal Type	Free Height	Cross Section Code	Preferred Seal Diameters (all dimensions are in inches)										
ESI	0.062	05	0.574	1.091									
			0.644	1.742									
			0.682	1.787									
			0.778	3.620									
			0.787	3.693									
			0.972										
ESI	0.094	07	0.737	1.167	1.489	1.765	2.035	2.272	2.598	3.339	4.598		
			0.813	1.246	1.494	1.790	2.040	2.296	2.705	3.361	4.602		
			0.888	1.307	1.562	1.803	2.064	2.378	2.711	3.931	5.238		
			0.940	1.331	1.624	1.811	2.070	2.390	2.835	4.043	5.417		
			1.010	1.400	1.627	1.890	2.132	2.425	2.955	4.116	6.047		
			1.030	1.406	1.666	1.942	2.158	2.441	2.980	4.173	7.310		
			1.095	1.411	1.720	1.954	2.271	2.541	3.163	4.255			
ESI	0.125	09	1.016	1.323	1.890	2.456	2.888	3.465	4.390	5.337	6.114		
			1.024	1.373	2.096	2.478	3.046	3.617	4.488	5.365	6.218		
			1.087	1.560	2.221	2.503	3.114	3.622	4.749	5.433	6.469		
			1.139	1.725	2.237	2.591	3.126	3.836	4.758	5.466	6.492		
			1.157	1.764	2.351	2.617	3.146	3.858	4.759	5.551	6.755		
			1.177	1.825	2.390	2.716	3.307	3.973	4.795	5.805	6.760		
			1.186	1.870	2.429	2.726	3.320	4.117	5.004	5.984			
			1.304	1.886	2.441	2.770	3.382	4.291	5.102	6.001			
ESI	.156	11	1.874	2.349	3.251	4.582	5.433	6.289					
			1.878	2.776	3.316	4.803	5.453	7.032					
			1.946	2.835	3.346	4.852	5.461	7.470					
			2.156	2.982	3.355	4.882	5.627	7.874					
			2.234	3.031	3.371	5.118	5.717	8.456					
ESI	0.188	13	2.498	3.233	4.724	5.808							
			2.746	3.372	4.735	5.989							
			2.868	4.293	4.808	6.102							
			2.932	4.375	5.548	7.507							
			2.956	4.465	5.556	8.532							
ESI	.250	15	4.300	5.402									
			4.980	5.484									
			5.106	5.697									

**WARNING**

These products can expose you to chemicals including carbon black (airborne and extracts), antimony trioxide, titanium dioxide, silica (crystalline), di(2-ethylhexyl)phthalate, ethylene thiourea, acrylonitrile, 1,3-butadiene, epichlorohydrin, toluene diisocyanate, tetrafluoroethylene, ethylbenzene, formaldehyde, furfuryl alcohol, glass fibers, methyl isobutyl ketone, nickel (metallic and compounds), lead and lead compounds which are known to the state of California to cause cancer; and 1,3-butadiene, epichlorohydrin, di(2-ethylhexyl)phthalate, di-isodecyl phthalate, ethylene thiourea, methyl isobutyl ketone, methanol, toluene, lead and lead compounds which are known to the state of California to cause birth defects and other reproductive harm. For more information go to [www.P65Warnings.ca.gov](http://www.P65Warnings.ca.gov).



Preferred C-Ring Sizes External Pressure Face Seal												
Seal Type	Free Height	Cross Section Code	Preferred Seal Diameters (all dimensions are in inches)									
			ECE	0.031	01 & 02	0.195 0.200 0.252	0.283 0.285 0.288	0.301 0.308 0.315	0.385 0.391 0.408	0.443 0.467 0.471	0.500 0.565 0.585	0.594 0.629 0.760
ECE	0.047	03 & 04	0.220 0.320 0.326 0.341	0.393 0.502 0.510 0.559	0.568 0.591 0.658 0.677	0.680 0.796 0.798 0.904	0.905 0.945 0.980 1.026	1.069 1.080 1.109 1.150	1.161 1.182 1.190 1.201	1.243 1.293 1.364 1.465	1.544 1.638 1.831	
ECE	0.062	05 & 06	0.178 0.187 0.209 0.237 0.258 0.265 0.311 0.364 0.375 0.377 0.398 0.417	0.436 0.442 0.450 0.478 0.496 0.528 0.539 0.542 0.569 0.615 0.618 0.620	0.640 0.688 0.700 0.711 0.712 0.717 0.739 0.758 0.764 0.785 0.807 0.809	0.813 0.820 0.832 0.841 0.847 0.875 0.877 0.981 0.985 0.994 1.006 1.010	1.040 1.052 1.076 1.093 1.112 1.115 1.119 1.173 1.184 1.209 1.250 1.252	1.254 1.299 1.314 1.324 1.375 1.450 1.500 1.502 1.518 1.557 1.580 1.582	1.586 1.594 1.660 1.739 1.741 1.750 1.760 1.875 2.019 2.181 2.250 2.255	2.315 2.330 2.346 2.375 2.438 2.440 2.496 2.500 2.628 2.756 2.824 2.873	2.932 2.990 3.000 3.071 3.313 3.375 3.441 3.490 3.500 3.524 3.631 4.000	4.062 4.188 4.317 4.710 4.988 4.991 5.250 5.738 5.964 7.377 8.400
ECE	0.094	07 & 08	0.138 0.400 0.453 0.472 0.480 0.516 0.596 0.630 0.685 0.723 0.726 0.745 0.746	0.748 0.750 0.783 0.789 0.815 0.874 0.877 0.908 0.937 0.971 1.002 1.035 1.056	1.095 1.098 1.110 1.125 1.131 1.149 1.173 1.177 1.187 1.191 1.198 1.227 1.230	1.244 1.248 1.252 1.270 1.331 1.385 1.410 1.427 1.490 1.494 1.500 1.516 1.521	1.565 1.587 1.600 1.627 1.654 1.695 1.726 1.732 1.733 1.735 1.740 1.802 1.804	1.829 1.841 1.873 1.877 1.882 1.885 1.935 1.939 2.003 2.063 2.097 2.128 2.197	2.248 2.350 2.377 2.460 2.470 2.498 2.506 2.559 2.686 2.690 2.750 2.753 2.790	2.799 2.875 2.878 2.992 3.003 3.007 3.024 3.053 3.170 3.200 3.205 3.307 3.445	3.523 3.603 3.610 3.625 3.628 3.740 3.750 3.768 3.770 4.130 4.134 4.250 4.404	4.438 4.567 4.620 4.625 4.919 5.000 5.195 5.505 5.625 5.875 6.565 7.750 8.500
ECE	0.125	09 & 10	0.886 0.925 0.982 1.043 1.061 1.094 1.107 1.232 1.259 1.267 1.280 1.287 1.317 1.377	1.426 1.527 1.577 1.661 1.721 1.766 1.792 1.907 1.966 1.993 2.056 2.125 2.165 2.214	2.258 2.290 2.291 2.314 2.378 2.446 2.503 2.505 2.512 2.558 2.562 2.606 2.650 2.756	2.812 2.827 2.877 2.947 3.005 3.006 3.125 3.182 3.192 3.197 3.240 3.279 3.375 3.503	3.619 3.688 3.745 3.828 3.838 3.858 3.916 3.948 3.975 4.094 4.100 4.147 4.306 4.375	4.449 4.503 4.506 4.606 4.628 4.755 4.796 4.856 4.882 4.934 4.939 4.941 4.946 4.968	4.980 4.998 5.032 5.060 5.079 5.245 5.265 5.287 5.315 5.323 5.326 5.381 5.409 5.500	5.512 5.565 5.635 5.665 5.720 5.750 5.765 5.912 6.000 6.003 6.075 6.125 6.142 6.217	6.249 6.254 6.261 6.377 6.468 6.625 6.839 6.845 6.852 7.000 7.157 7.170 7.437 7.510	8.227 8.263 8.753 9.253 13.998
ECE	0.156	11 & 12	1.180 1.186 1.470 1.773	1.916 2.087 2.118 2.345	2.380 2.417 2.764 2.785	2.878 2.970 3.418 3.929	3.943 4.096 4.128 4.136	4.260 4.287 4.378 4.537	4.626 4.629 4.812 4.852	5.125 5.128 5.134 5.230	5.534 5.906 6.112 6.142	7.141 9.576 10.600
ECE	0.188	13 & 14	1.765 2.067 2.582 3.258	3.262 3.404 3.609 3.738	3.878 3.937 4.122 4.128	4.154 4.207 4.370 4.878	4.930 5.220 5.514 5.622	5.965 6.055 6.628 6.634	6.965 7.131 7.141 7.500	7.541 7.761 8.128		
ECE	0.250	15 & 16	5.233 5.550 5.553 5.555	5.906 6.406 7.301 7.323	7.858							

Section E  
Technical Information

**WARNING**  
 These products can expose you to chemicals including carbon black (airborne and extracts), antimony trioxide, titanium dioxide, silica (crystalline), di(2-ethylhexyl)phthalate, ethylene thiourea, acrylonitrile, 1,3-butadiene, epichlorohydrin, toluene diisocyanate, tetrafluoroethylene, ethylbenzene, formaldehyde, furfuryl alcohol, glass fibers, methyl isobutyl ketone, nickel (metallic and compounds), lead and lead compounds which are known to the state of California to cause cancer; and 1,3-butadiene, epichlorohydrin, di(2-ethylhexyl)phthalate, di-isodecyl phthalate, ethylene thiourea, methyl isobutyl ketone, methanol, toluene, lead and lead compounds which are known to the state of California to cause birth defects and other reproductive harm. For more information go to [www.P65Warnings.ca.gov](http://www.P65Warnings.ca.gov).



## Preferred C-Ring Sizes Internal Pressure Face Seal

Preferred Spring Energized C-Ring Sizes External Pressure Face Seal												
Seal Type	Free Height	Cross Section Code	Preferred Seal Diameters (all dimensions are in inches)									
			ESE	0.062	05	0.332 0.953 1.100 1.256	1.346 1.350 1.602 1.976	2.825 3.081 3.850				
ESE	0.094	07	0.235 0.636 0.789 0.931 0.980	1.001 1.007 1.071 1.085 1.194	1.217 1.260 1.346 1.465 1.577	1.661 1.722 1.760 1.920 2.138	2.157 2.335 2.366 2.476 2.579	2.601 2.650 2.843 2.893 3.157	3.501 3.504 3.546 3.610 3.625	4.010 4.018 4.142 4.187 4.341	4.656 4.890 5.318 5.552 5.574	7.728 7.941
ESE	0.125	09	0.762 0.784 0.879 0.926 0.977	1.107 1.118 1.268 1.322 1.347	1.357 1.622 1.780 1.815 1.961	1.976 2.067 2.128 2.173 2.372	2.626 2.750 2.939 3.150 3.279	3.701 3.846 3.941 3.949 4.085	4.367 4.646 4.736 5.127 5.157	5.225 5.303 5.528 5.724 5.739	6.378 6.382 6.575 6.753 7.087	
ESE	0.156	11	1.443 1.634 2.290 2.300	2.764 2.815 3.268 3.543	3.593 3.958 4.287 4.331	4.390 4.420 4.644 5.315	5.641 6.285 6.417 7.283	7.717				
ESE	0.188	13	1.880 2.684 3.736 3.876	4.100 4.851 5.167 5.622	5.709							
ESE	0.250	15	2.228 4.512 4.787 5.457	6.036 6.339 7.412								

**⚠ WARNING**

These products can expose you to chemicals including carbon black (airborne and extracts), antimony trioxide, titanium dioxide, silica (crystalline), di(2-ethylhexyl)phthalate, ethylene thiourea, acrylonitrile, 1,3-butadiene, epichlorohydrin, toluene diisocyanate, tetrafluoroethylene, ethylbenzene, formaldehyde, furfuryl alcohol, glass fibers, methyl isobutyl ketone, nickel (metallic and compounds), lead and lead compounds which are known to the state of California to cause cancer; and 1,3-butadiene, epichlorohydrin, di(2-ethylhexyl)phthalate, di-isodecyl phthalate, ethylene thiourea, methyl isobutyl ketone, methanol, toluene, lead and lead compounds which are known to the state of California to cause birth defects and other reproductive harm. For more information go to [www.P65Warnings.ca.gov](http://www.P65Warnings.ca.gov).

Preferred Axial C-Ring Sizes												
Seal Type	Free Height	Cross Section Code	Preferred Seal Diameters (all dimensions are in inches)									
			ECA	0.031	01	0.219 0.250	0.313 0.330	0.536 0.688	0.718 1.072			
ECA	0.047	03	0.281 0.350	0.425 0.595	0.625 0.626	0.656 0.720	0.751 0.813	0.938 0.967	0.978 1.126	1.233 1.469		
ECA	0.062	05	0.318 0.370 0.376 0.426 0.427 0.429	0.438 0.469 0.501 0.503 0.551 0.562	0.564 0.628 0.633 0.657 0.672 0.686	0.752 0.791 0.795 0.835 0.876 0.879	0.882 0.900 0.902 0.907 0.949 0.999	1.000 1.001 1.016 1.024 1.063 1.086	1.127 1.130 1.188 1.253 1.257 1.263	1.341 1.376 1.381 1.503 1.504 1.609	1.629 1.768 2.127 2.285 2.816	
ECA	0.094	07	0.588 0.855 0.938 0.939 0.968 0.986	1.054 1.086 1.135 1.170 1.192 1.240	1.269 1.313 1.315 1.348 1.375 1.378	1.417 1.438 1.439 1.560 1.563 1.565	1.578 1.625 1.628 1.634 1.677 1.684	1.688 1.726 1.752 1.753 1.781 1.864	1.938 1.940 1.942 1.979 1.986 2.011	2.019 2.094 2.138 2.156 2.186 2.188	2.313 2.357 2.559 2.603 2.787 2.872	2.938 3.008 3.072 3.150 3.203 3.594
ECA	0.125	09	0.878 1.251 1.476 1.498 1.751 2.000 2.066 2.126 2.129	2.165 2.252 2.340 2.499 2.501 2.562 2.595 2.625 2.626	2.754 2.755 2.804 2.806 2.831 2.846 2.880 2.894 2.925	2.952 2.953 2.976 3.001 3.004 3.031 3.060 3.067 3.128	3.130 3.181 3.248 3.250 3.256 3.370 3.374 3.438 3.455	3.499 3.520 3.555 3.607 3.624 3.626 3.739 3.749 3.756	3.784 3.874 3.945 3.979 3.997 3.999 4.025 4.499 4.500	4.624 4.750 4.756 4.780 4.814 4.850 4.906 4.961 4.999	5.162 5.249 5.330 5.499 5.734 5.749 5.956 6.070 6.079	6.258 7.139 7.648 7.874 10.977 11.177
ECA	0.156	11	2.378 4.095 4.531	4.705 4.806 4.861	5.101 5.267 5.615	5.654 5.686 5.812	6.160 6.375 6.507	6.312 6.614 7.057	7.250 7.383 7.806	8.669 8.750 9.039	9.414 12.764	
ECA	0.188	13	2.954 5.256 5.372	5.732 6.264 6.510	6.708 6.774 6.874	6.937 7.004 7.105	7.235 7.251 7.374	7.691 7.899 8.624	9.124 9.292 9.843	10.607 11.189 12.000	12.138	
ECA	0.250	15	1.630 4.908	9.000 9.233	10.383 11.030	12.185 13.000	15.266 16.385					

Preferred Spring Energized Axial C-Ring												
Seal Type	Free Height	Cross Section Code	Preferred Seal Diameters (all dimensions are in inches)									
			ESA	0.047	03	0.410						
ESA	0.062	05	0.554	0.914	1.377	1.626	3.127					
ESA	0.094	07	3.712									
ESA	0.125	09	1.641	2.680	4.764	5.503	5.942	6.186				
ESA	0.188	13	2.956	11.170								

**WARNING**  
 These products can expose you to chemicals including carbon black (airborne and extracts), antimony trioxide, titanium dioxide, silica (crystalline), di(2-ethylhexyl)phthalate, ethylene thiourea, acrylonitrile, 1,3-butadiene, epichlorohydrin, toluene diisocyanate, tetrafluoroethylene, ethylbenzene, formaldehyde, furfuryl alcohol, glass fibers, methyl isobutyl ketone, nickel (metallic and compounds), lead and lead compounds which are known to the state of California to cause cancer; and 1,3-butadiene, epichlorohydrin, di(2-ethylhexyl)phthalate, di-isodecyl phthalate, ethylene thiourea, methyl isobutyl ketone, methanol, toluene, lead and lead compounds which are known to the state of California to cause birth defects and other reproductive harm. For more information go to [www.P65Warnings.ca.gov](http://www.P65Warnings.ca.gov).



## Tolerance Reference Tables

The tolerance tables below are consistent with the American National Standard Tolerances (ANSI B4.1) and the British Standard for Metric ISO Limits and Fits (BS 4500).

ANSI B4.1		TOLERANCE GRADE			
Nominal Diameter (inches)		h10 Cavity ID	H10 Cavity OD	h11 Seal OD	H11 Seal ID
Over	To	(Dimensions are in 0.001 inches)			
0	– 0.12	+ 0.0 / – 1.6	– 0.0 / + 1.6	+ 0.0 / – 2.5	– 0.0 / + 2.5
0.12	– 0.24	+ 0.0 / – 1.8	– 0.0 / + 1.8	+ 0.0 / – 3.0	– 0.0 / + 3.0
0.24	– 0.40	+ 0.0 / – 2.2	– 0.0 / + 2.2	+ 0.0 / – 3.5	– 0.0 / + 3.5
0.40	– 0.71	+ 0.0 / – 2.8	– 0.0 / + 2.8	+ 0.0 / – 4.0	– 0.0 / + 4.0
0.71	– 1.19	+ 0.0 / – 3.5	– 0.0 / + 3.5	+ 0.0 / – 5.0	– 0.0 / + 5.0
1.19	– 1.97	+ 0.0 / – 4.0	– 0.0 / + 4.0	+ 0.0 / – 6.0	– 0.0 / + 6.0
1.97	– 3.15	+ 0.0 / – 4.5	– 0.0 / + 4.5	+ 0.0 / – 7.0	– 0.0 / + 7.0
3.15	– 4.73	+ 0.0 / – 5.0	– 0.0 / + 5.0	+ 0.0 / – 9.0	– 0.0 / + 9.0
4.73	– 7.09	+ 0.0 / – 6.0	– 0.0 / + 6.0	+ 0.0 / – 10.0	– 0.0 / + 10.0
7.09	– 9.85	+ 0.0 / – 7.0	– 0.0 / + 7.0	+ 0.0 / – 12.0	– 0.0 / + 12.0
9.85	– 12.41	+ 0.0 / – 8.0	– 0.0 / + 8.0	+ 0.0 / – 12.0	– 0.0 / + 12.0
12.41	– 15.75	+ 0.0 / – 9.0	– 0.0 / + 9.0	+ 0.0 / – 14.0	– 0.0 / + 14.0
15.75	– 19.69	+ 0.0 / – 10.0	– 0.0 / + 10.0	+ 0.0 / – 16.0	– 0.0 / + 16.0
19.69	– 30.09	+ 0.0 / – 12.0	– 0.0 / + 12.0	+ 0.0 / – 20.0	– 0.0 / + 20.0
30.09	– 41.49	+ 0.0 / – 16.0	– 0.0 / + 16.0	+ 0.0 / – 25.0	– 0.0 / + 25.0
41.49	– 56.19	+ 0.0 / – 20.0	– 0.0 / + 20.0	+ 0.0 / – 30.0	– 0.0 / + 30.0
56.19	– 76.39	+ 0.0 / – 25.0	– 0.0 / + 25.0	+ 0.0 / – 40.0	– 0.0 / + 40.0

BS 4500		TOLERANCE GRADE			
Nominal Diameter (mm)		h10 Cavity ID	H10 Cavity OD	h11 Seal OD	H11 Seal ID
Over	To	(Dimensions are in 0,001 millimeters)			
0	– 3	+ 0,0 / – 40	– 0,0 / + 40	+ 0,0 / – 60	– 0,0 / + 60
3	– 6	+ 0,0 / – 48	– 0,0 / + 48	+ 0,0 / – 75	– 0,0 / + 75
6	– 10	+ 0,0 / – 58	– 0,0 / + 58	+ 0,0 / – 90	– 0,0 / + 90
10	– 18	+ 0,0 / – 70	– 0,0 / + 70	+ 0,0 / – 110	– 0,0 / + 110
18	– 30	+ 0,0 / – 84	– 0,0 / + 84	+ 0,0 / – 130	– 0,0 / + 130
30	– 50	+ 0,0 / – 100	– 0,0 / + 100	+ 0,0 / – 160	– 0,0 / + 160
50	– 80	+ 0,0 / – 120	– 0,0 / + 120	+ 0,0 / – 190	– 0,0 / + 190
80	– 120	+ 0,0 / – 140	– 0,0 / + 140	+ 0,0 / – 220	– 0,0 / + 220
120	– 180	+ 0,0 / – 160	– 0,0 / + 160	+ 0,0 / – 250	– 0,0 / + 250
180	– 250	+ 0,0 / – 185	– 0,0 / + 185	+ 0,0 / – 290	– 0,0 / + 290
250	– 315	+ 0,0 / – 210	– 0,0 / + 210	+ 0,0 / – 320	– 0,0 / + 320
315	– 400	+ 0,0 / – 230	– 0,0 / + 230	+ 0,0 / – 360	– 0,0 / + 360
400	– 500	+ 0,0 / – 250	– 0,0 / + 250	+ 0,0 / – 400	– 0,0 / + 400
500	– 760	+ 0,0 / – 300	– 0,0 / + 300	+ 0,0 / – 500	– 0,0 / + 500
760	– 1050	+ 0,0 / – 400	– 0,0 / + 400	+ 0,0 / – 630	– 0,0 / + 630
1050	– 1425	+ 0,0 / – 500	– 0,0 / + 500	+ 0,0 / – 760	– 0,0 / + 760
1425	– 1940	+ 0,0 / – 630	– 0,0 / + 630	+ 0,0 / – 1000	– 0,0 / + 1000

All tolerances above heavy line are in accordance with American-British-Canadian (ABC) Agreements.

### ⚠ WARNING

These products can expose you to chemicals including carbon black (airborne and extracts), antimony trioxide, titanium dioxide, silica (crystalline), di(2-ethylhexyl)phthalate, ethylene thiourea, acrylonitrile, 1,3-butadiene, epichlorohydrin, toluene diisocyanate, tetrafluoroethylene, ethylbenzene, formaldehyde, furfuryl alcohol, glass fibers, methyl isobutyl ketone, nickel (metallic and compounds), lead and lead compounds which are known to the state of California to cause cancer; and 1,3-butadiene, epichlorohydrin, di(2-ethylhexyl)phthalate, di-isodecyl phthalate, ethylene thiourea, methyl isobutyl ketone, methanol, toluene, lead and lead compounds which are known to the state of California to cause birth defects and other reproductive harm. For more information go to [www.P65Warnings.ca.gov](http://www.P65Warnings.ca.gov).

# Conversion Tables

Pressure											
TO OBTAIN		atmosphere	bar	inches of mercury	inches of water	millimeters of mercury (Torr)	millimeters of water	kPa	MPa	Newtons/m <sup>2</sup> (Pascal)	pounds/square inch
atmosphere	by	1	1.0133	29.9210	4.0678x10 <sup>2</sup>	7.6000x10 <sup>2</sup>	1.0332x10 <sup>4</sup>	1.0133x10 <sup>-1</sup>	1.0133x10 <sup>-1</sup>	1.0133x10 <sup>5</sup>	14.6960
bar	by	9.8692x10 <sup>-1</sup>	1	29.5300	4.0146x10 <sup>2</sup>	7.5006x10 <sup>2</sup>	1.0197x10 <sup>4</sup>	1.000x10 <sup>-2</sup>	1.0000x10 <sup>-1</sup>	1.0000x10 <sup>5</sup>	14.5038
inches of mercury	by	3.3421x10 <sup>-2</sup>	3.3864x10 <sup>-2</sup>	1	13.5950	25.4000	3.4532x10 <sup>2</sup>	3.3864	3.3864x10 <sup>-3</sup>	3.3864x10 <sup>3</sup>	4.9116x10 <sup>-1</sup>
inches of water	by	2.4584x10 <sup>-3</sup>	2.4840x10 <sup>-3</sup>	7.3556x10 <sup>-2</sup>	1	1.8685	25.4000	2.4910x10 <sup>-1</sup>	2.4910x10 <sup>-2</sup>	2.4910x10 <sup>2</sup>	3.6128x10 <sup>-2</sup>
millimeters of mercury (Torr)	by	1.3158x10 <sup>-3</sup>	1.3332x10 <sup>-3</sup>	3.9370x10 <sup>-2</sup>	5.3520x10 <sup>-1</sup>	1	13.5950	1.3332x10 <sup>-1</sup>	9.8068	1.3332x10 <sup>2</sup>	1.9337x10 <sup>-2</sup>
millimeters of water	by	9.6787x10 <sup>-5</sup>	9.8068x10 <sup>-5</sup>	2.8959x10 <sup>-3</sup>	3.9370x10 <sup>-2</sup>	7.3556x10 <sup>-2</sup>	1	9.8068x10 <sup>-3</sup>	1.0000x10 <sup>-3</sup>	9.8068	1.4223x10 <sup>-3</sup>
kPa	by	9.8692x10 <sup>-3</sup>	1.0000x10 <sup>-2</sup>	2.9530x10 <sup>-1</sup>	4.0146	7.5006	1.0197x10 <sup>-2</sup>	1	1.0000x10 <sup>-6</sup>	1.0000x10 <sup>3</sup>	1.4504x10 <sup>-1</sup>
MPa	by	9.8692	10.0000	2.9530x10 <sup>2</sup>	4.0146x10 <sup>3</sup>	7.5006x10 <sup>3</sup>	1.0197x10 <sup>5</sup>	1.0000x10 <sup>-6</sup>	1	1.0000x10 <sup>6</sup>	1.4504x10 <sup>2</sup>
Newtons/m <sup>2</sup> (Pascal)	by	9.8692x10 <sup>-6</sup>	1.0000x10 <sup>-5</sup>	2.9530x10 <sup>-4</sup>	4.0146x10 <sup>-3</sup>	7.5006x10 <sup>-3</sup>	1.0197x10 <sup>-1</sup>	6.8948x10 <sup>-3</sup>	6.8948x10 <sup>-3</sup>	1	1.4504x10 <sup>-4</sup>
pounds/square inch	by	6.8046x10 <sup>-2</sup>	6.8947x10 <sup>-2</sup>	2.0360	27.6810	51.7144	7.0310x10 <sup>2</sup>	6.8948	6.8948x10 <sup>-3</sup>	6.8948x10 <sup>3</sup>	1

## Temperature

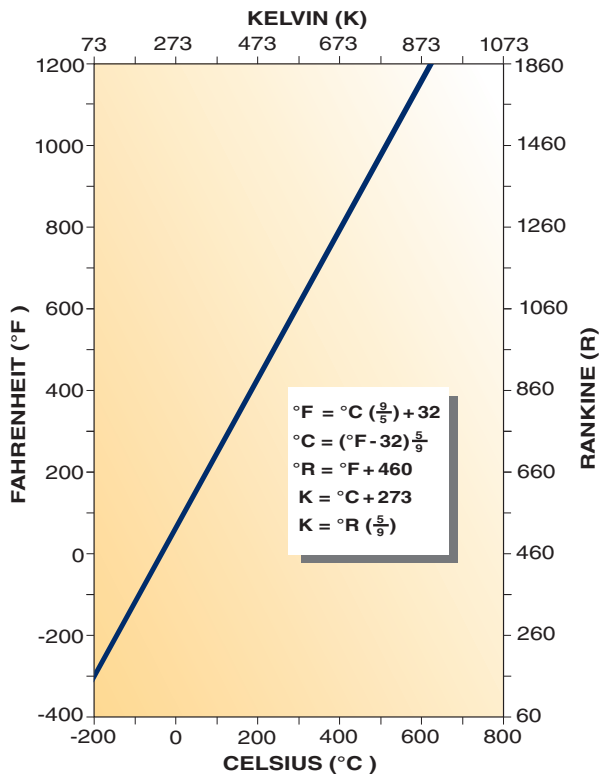

## Torque [Moment]

TO OBTAIN		N-m	kg-m	kg-cm	ft-lb	Inch-lb
N-m	by	1	0.1020	10.1970	0.7376	8.8509
kg-m	by	9.8068	1	100.0000	7.2330	86.7942
kg-cm	by	0.0981	0.0100	1	0.0723	0.8679
ft-lb	by	1.3558	0.1383	13.8255	1	12.0000
inch-lb	by	0.1130	0.0115	1.1522	0.0833	1

## Force

TO OBTAIN		newton	kilogram	pound
newton	by	1	0.1020	0.2248
kilogram	by	9.8068	1	2.2046
pound	by	4.4482	0.4536	1

## Distributed Force [Force per unit length]

TO OBTAIN		N/mm	kg/cm	lb/in
N/mm	by	1	1.0197	5.7102
kg/cm	by	0.9807	1	5.5997
lb/in	by	0.1751	0.1786	1

For leakage rate conversion refer to page E-80.

### WARNING

These products can expose you to chemicals including carbon black (airborne and extracts), antimony trioxide, titanium dioxide, silica (crystalline), di(2-ethylhexyl)phthalate, ethylene thiourea, acrylonitrile, 1,3-butadiene, epichlorohydrin, toluene diisocyanate, tetrafluoroethylene, ethylbenzene, formaldehyde, furfuryl alcohol, glass fibers, methyl isobutyl ketone, nickel (metallic and compounds), lead and lead compounds which are known to the state of California to cause cancer; and 1,3-butadiene, epichlorohydrin, di(2-ethylhexyl)phthalate, di-isodecyl phthalate, ethylene thiourea, methyl isobutyl ketone, methanol, toluene, lead and lead compounds which are known to the state of California to cause birth defects and other reproductive harm. For more information go to [www.P65Warnings.ca.gov](http://www.P65Warnings.ca.gov).



 **WARNING**

These products can expose you to chemicals including carbon black (airborne and extracts), antimony trioxide, titanium dioxide, silica (crystalline), di(2-ethylhexyl)phthalate, ethylene thiourea, acrylonitrile, 1,3-butadiene, epichlorohydrin, toluene diisocyanate, tetrafluoroethylene, ethylbenzene, formaldehyde, furfuryl alcohol, glass fibers, methyl isobutyl ketone, nickel (metallic and compounds), lead and lead compounds which are known to the state of California to cause cancer; and 1,3-butadiene, epichlorohydrin, di(2-ethylhexyl)phthalate, di-isodecyl phthalate, ethylene thiourea, methyl isobutyl ketone, methanol, toluene, lead and lead compounds which are known to the state of California to cause birth defects and other reproductive harm. For more information go to [www.P65Warnings.ca.gov](http://www.P65Warnings.ca.gov).

## Section F – Additional Metal Seal Styles

The seals shown and described in Section C of this design guide have been designed, tested and carefully selected as our standard line of metal seals. Using the standard metal seals will satisfy the vast majority of applications and sealing requirements.

There are however, applications which have unique demands and we are pleased to offer our sealing expertise in developing sealing solutions for your specialized applications. Our extensive manufacturing capabilities allow us to quickly produce prototype seals which can be tested in our laboratories to verify leak rate, compressive load and springback.

For over 50 years we have been designing and manufacturing customized seals along with our standard product line. Please advise us of your requirements by filling out a copy of the “Application Data Sheet” included as pages F-103 and F-104 of this design manual. Please send the completed “Application Data Sheet” to Parker. We will respond quickly with detailed recommendations.

The following pages provide a brief overview of the wide range of unique seals we can offer, including:

- Various Formed Seals
- Precision Machined Seals
- Beaded Gaskets



<b>This section includes:</b>	<b>Page</b>
<b>Formed Seals</b> .....	F-96
<b>Precision Machined Seals</b> .....	F-96
<b>Beaded Gaskets</b> .....	F-97
<b>Additional E-Ring Styles</b> .....	F-98
<b>Frequently Asked Questions</b> .....	F-99
<b>Application Data Sheets</b>	
Face Seal .....	F-103
Axial Seal .....	F-104

**⚠ WARNING**

These products can expose you to chemicals including carbon black (airborne and extracts), antimony trioxide, titanium dioxide, silica (crystalline), di(2-ethylhexyl)phthalate, ethylene thiourea, acrylonitrile, 1,3-butadiene, epichlorohydrin, toluene diisocyanate, tetrafluoroethylene, ethylbenzene, formaldehyde, furfuryl alcohol, glass fibers, methyl isobutyl ketone, nickel (metallic and compounds), lead and lead compounds which are known to the state of California to cause cancer; and 1,3-butadiene, epichlorohydrin, di(2-ethylhexyl)phthalate, di-isodecyl phthalate, ethylene thiourea, methyl isobutyl ketone, methanol, toluene, lead and lead compounds which are known to the state of California to cause birth defects and other reproductive harm. For more information go to [www.P65Warnings.ca.gov](http://www.P65Warnings.ca.gov).



## Formed Seals

Formed seals are produced from metal strip which is formed into various cross sectional sizes and shapes to suit the needs of the application.

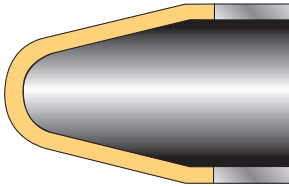

The **formed V-ring** is a low load, versatile seal which can be manufactured for a wide range of cavity sizes and depths. It has excellent springback.

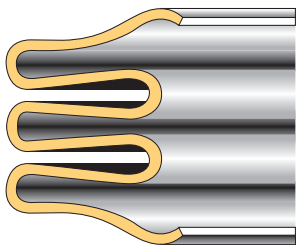

The customized **E-ring** can be designed with a large number and variety of convolutions. These seals provide exceptional springback when flange separation is of primary concern.

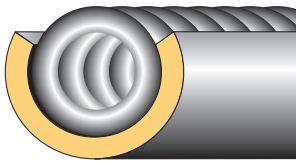

The **spring energized axial C-ring** is very similar to the standard, non-spring energized axial C-Ring. However, due to the additional sealing stress created by the spring, it is capable of sealing higher reversing pressures.

## Precision Machined Seals

The seal below is an example of the type of seal that is produced in our machine shop. It is machined to very tight tolerances and is available in sizes that are smaller than formed seals.

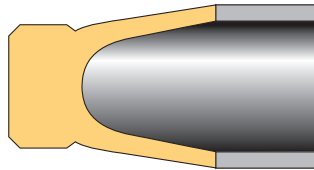

The **machined V-ring** is a popular seal intended for use in precision flanges with surface finishes of 4-16  $\mu$  inch (0,1-0,4  $\mu$  m)  $R_a$ . The "heel" end is designed to serve as a compression limiter allowing the seal to be used without a groove.

### ⚠ WARNING

These products can expose you to chemicals including carbon black (airborne and extracts), antimony trioxide, titanium dioxide, silica (crystalline), di(2-ethylhexyl)phthalate, ethylene thiourea, acrylonitrile, 1,3-butadiene, epichlorohydrin, toluene diisocyanate, tetrafluoroethylene, ethylbenzene, formaldehyde, furfuryl alcohol, glass fibers, methyl isobutyl ketone, nickel (metallic and compounds), lead and lead compounds which are known to the state of California to cause cancer; and 1,3-butadiene, epichlorohydrin, di(2-ethylhexyl)phthalate, di-isodecyl phthalate, ethylene thiourea, methyl isobutyl ketone, methanol, toluene, lead and lead compounds which are known to the state of California to cause birth defects and other reproductive harm. For more information go to [www.P65Warnings.ca.gov](http://www.P65Warnings.ca.gov).



## Beaded Gaskets

Beaded gaskets are inexpensively laser cut or stamped from a metal sheet. They are then embossed with a ridge, or “bead” which acts as the sealing surface of the gasket. The seals can be cut to virtually any shape and include bolt holes to facilitate installation. As the mating flanges are bolted together the raised bead of the gasket produces a higher sealing stress than a plain flat gasket.

Two typical beaded gaskets are shown below. Simply send a copy of your flange drawing to Parker and we will design a beaded gasket for you.

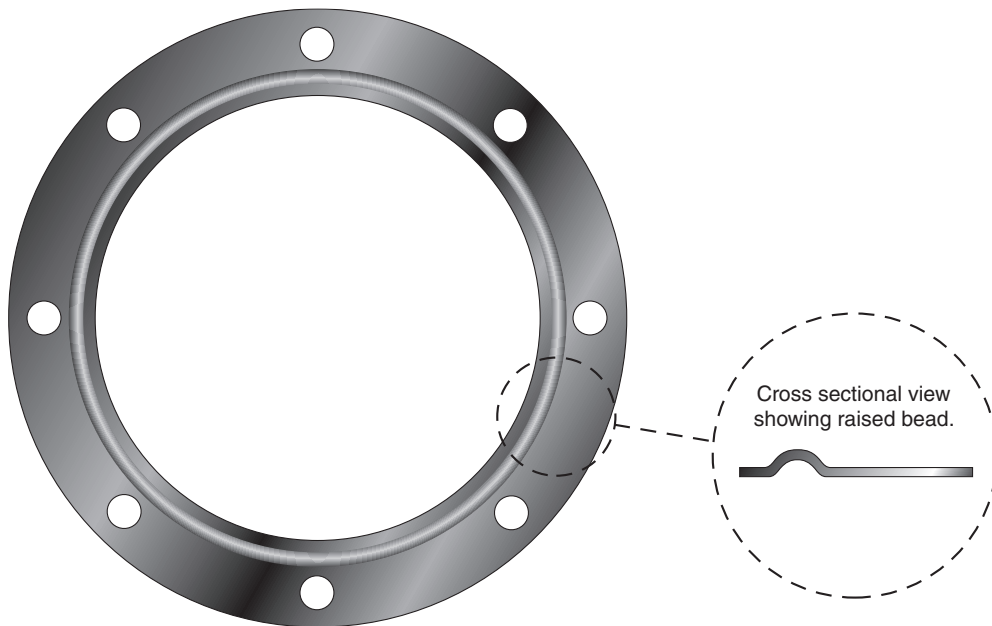
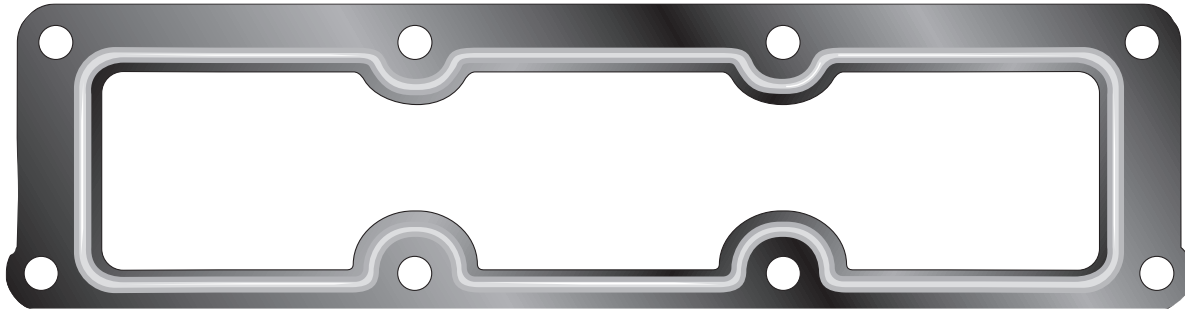































































**⚠ WARNING**

These products can expose you to chemicals including carbon black (airborne and extracts), antimony trioxide, titanium dioxide, silica (crystalline), di(2-ethylhexyl)phthalate, ethylene thiourea, acrylonitrile, 1,3-butadiene, epichlorohydrin, toluene diisocyanate, tetrafluoroethylene, ethylbenzene, formaldehyde, furfuryl alcohol, glass fibers, methyl isobutyl ketone, nickel (metallic and compounds), lead and lead compounds which are known to the state of California to cause cancer; and 1,3-butadiene, epichlorohydrin, di(2-ethylhexyl)phthalate, di-isodecyl phthalate, ethylene thiourea, methyl isobutyl ketone, methanol, toluene, lead and lead compounds which are known to the state of California to cause birth defects and other reproductive harm. For more information go to [www.P65Warnings.ca.gov](http://www.P65Warnings.ca.gov).



## Additional E-Ring Styles

Many custom cross sections are available.

33101 	69222 	69294 	69375 	69432 	69518 	69883 
33124 	69223  3/32-7	69295 	69385 	69434 	69550 	69982 
33126 	69224  3/32-8	69298 	69397 	69436 	69552 	69986 
40060 	69225 	69312 	69425 	69437 	69597 	69987 
40293 	69226  1/16-5	69315 	69426 	69439 	69642 	69990 
690118 	69228  1/4-15	69317 	69428 	69440 	69654 	79002  3/32-7
690127 	69241 	69323 	69429 	69445 	69659 	79003  1/8-9
690195 	69253 	69373 	69430 	69447 	69812 	79004 
69221  3/16-13	69292 	69374 	69431  1/8-11	69488 	69881 	79005 

**WARNING**

These products can expose you to chemicals including carbon black (airborne and extracts), antimony trioxide, titanium dioxide, silica (crystalline), di(2-ethylhexyl)phthalate, ethylene thiourea, acrylonitrile, 1,3-butadiene, epichlorohydrin, toluene diisocyanate, tetrafluoroethylene, ethylbenzene, formaldehyde, furfuryl alcohol, glass fibers, methyl isobutyl ketone, nickel (metallic and compounds), lead and lead compounds which are known to the state of California to cause cancer; and 1,3-butadiene, epichlorohydrin, di(2-ethylhexyl)phthalate, di-isodecyl phthalate, ethylene thiourea, methyl isobutyl ketone, methanol, toluene, lead and lead compounds which are known to the state of California to cause birth defects and other reproductive harm. For more information go to [www.P65Warnings.ca.gov](http://www.P65Warnings.ca.gov).

## Frequently Asked Questions

### *How do I choose the right metal seal?*

Selecting the most appropriate seal for your application can save a lot of money by eliminating the tremendous costs associated with machine downtime, unscheduled service, and spill remediation.

We offer a wide variety of metal seals designed to meet the challenges of high temperatures or cryogenics, high pressures, vacuum, corrosive chemicals and even intense levels of radiation. Unlike rubber, composite, asbestos, and other organic gaskets, metal seals do not deteriorate over time due to compacting, outgassing or blowouts.

In addition, because the seating loads for metal seals can be significantly less than those required for crush-type gaskets, the strength and mass of the flanges can be reduced. This is particularly important to designers concerned with reducing size and weight.

### Different Needs

**C-ring** – provides a good combination of leak tightness and springback. It is one of the most popular designs.

**E-ring** – offers the greatest amount of springback of all metal seals.

**Metal O-ring** – used for over 50 years and remains an economical choice for high-load, high pressure sealing.

**Spring energized C-ring** – is similar to the standard C-ring, but it has an internal spring that produces much greater load for sealing against rough surfaces or when extreme leak tightness is required.

**Wire ring** – is a low cost, high load, crush type seal used with smooth mating surfaces and minimum relative movement.

**Face seal / axial seal** – keep in mind that metal face seals, which are ideal for static applications, are compressed by approximately 10% to 20% of their original free height to produce preferred sealing loads for optimized performance. Axial seals can be used in either static or semi-dynamic applications to seal against shafts and bores.

Due to the relative rigidity of metal seals in comparison to elastomeric and polymeric seals, the axial seals must be produced to tighter tolerances than face seal grooves. Face seals are generally preferred instead of axial seals due to their relative ease of gland manufacture, installation and seal performance.

**High Load vs High Elasticity** – high load metal seals are designed for extreme leak tightness. High elasticity seals provide resiliency or springback needed to maintain effective sealing during mating surface separation, such as with thermal cycling.

### WARNING

These products can expose you to chemicals including carbon black (airborne and extracts), antimony trioxide, titanium dioxide, silica (crystalline), di(2-ethylhexyl)phthalate, ethylene thiourea, acrylonitrile, 1,3-butadiene, epichlorohydrin, toluene diisocyanate, tetrafluoroethylene, ethylbenzene, formaldehyde, furfuryl alcohol, glass fibers, methyl isobutyl ketone, nickel (metallic and compounds), lead and lead compounds which are known to the state of California to cause cancer; and 1,3-butadiene, epichlorohydrin, di(2-ethylhexyl)phthalate, di-isodecyl phthalate, ethylene thiourea, methyl isobutyl ketone, methanol, toluene, lead and lead compounds which are known to the state of California to cause birth defects and other reproductive harm. For more information go to [www.P65Warnings.ca.gov](http://www.P65Warnings.ca.gov).



## Frequently Asked Questions

### A Variety of Metals

Metal seals are produced with a wide variety of materials including high performance nickel alloys such as Alloy 718, Alloy X-750 and Waspaloy. Heat treated to increase seating load and springback, these high-strength metals improve fatigue and creep resistance. Metal O-rings and spring energized C-rings are also often manufactured from austenitic stainless steels.

Material selection is based on operating conditions such as temperature and pressure as well as performance issues such as seating load and springback. Other factors that should be considered in the selection process are corrosion resistance and chemical compatibility. Special materials are available to meet unusually severe operational requirements.

### Are metal seals reusable?

This is one of the most common questions asked by our customers. Generally, metal seals are not considered to be reusable and are replaced after each use. However, after considering a few important issues, the customer must ultimately be the one who answers the question for themselves.

#### Issues to consider:

#### 1) What type of seal is it?

An E-ring provides nearly full elastic recovery after the compressive force is removed. E-rings usually are left unplated meaning there is no ductile outer surface which can be deformed into the hardened mating surface by compression. As a result, unplated E-rings and other low load seals are more suited for reuse than other metal seals. O-rings and C-rings undergo mostly plastic deformation and therefore are usually discarded after one use.

#### 2) What is the surface roughness of the mating hardware?

A rough surface will mean an equally rough impression into the soft plated surface of the seal. Reinstalling the seal will result in a mismatch of the plated surfaces and mating hardware surfaces. The surface roughness impression made in the plating upon initial installation may act as leak paths upon subsequent installations. Smooth surfaces will minimize this effect and improve the chances for seal reuse.

#### 3) How flat are the surfaces of the mating hardware?

When a seal is compressed it conforms to the waviness of the mating surfaces. When the seal is reinstalled it is likely that the waviness of the flange will not match with the waviness of the seal. This waviness mismatch may result in leak paths and non-uniform sealing forces on the circumference of the seal. Flat surfaces will increase the possibility for seal reuse.

#### 4) What if the seal leaks upon reuse?

In some applications the time, effort and cost of assembling the equipment or machinery is very high. The money saved by reusing the seal is minimal compared to the cost for disassembly and reassembly if the seal needs to be replaced. Most customers are not willing to risk the cost of the labor replacing the seal to save on the price of a seal. However, if the consequences of a leaking seal are small then the customer will likely be willing to reuse the seal.

After considering these issues the customer can decide whether or not to reuse the seal. Most customers will conclude that the seal should be replaced after each use.

### Why use a -8 heat treatment?

Sulfide stress cracking (SSC) is a special corrosion type, a form of stress corrosion cracking commonly found in oil field applications where hydrogen sulfide (H<sub>2</sub>S) may be present. Susceptible alloys, especially steels, react with hydrogen sulfide, forming metal sulfides and elementary atomic hydrogen. The atomic hydrogen diffuses into the metal matrix.

Stress corrosion cracking requires three simultaneous factors – surface tensile stress, alloy and environment. The alteration or elimination of any one of them can prevent this attack. Where possible, the alteration of the environment or the choice of a different alloy is the best solution. Elimination of stress is usually attempted through heat treatment.

Choosing materials with a high nickel content can greatly improve the resistance to sulfide stress cracking. Heat treating a high nickel content material such as Alloy 718 to reduce the tensile stress to meet the requirements of NACE MR0175 can greatly reduce sulfide stress cracking corrosion.

NACE standard MR0175 does not give a recipe for heat treatment. But it does state that a material such as Alloy 718 should not have a hardness greater than 40HRC. Our -8 heat treatment removes the tensile stress enough to meet the requirement, but still give some strength. The -8 heat treatment will have a reduced seating load of about 30% over our standard -6 solution anneal and age hardened heat treatment.

#### ⚠ WARNING

These products can expose you to chemicals including carbon black (airborne and extracts), antimony trioxide, titanium dioxide, silica (crystalline), di(2-ethylhexyl)phthalate, ethylene thiourea, acrylonitrile, 1,3-butadiene, epichlorohydrin, toluene diisocyanate, tetrafluoroethylene, ethylbenzene, formaldehyde, furfuryl alcohol, glass fibers, methyl isobutyl ketone, nickel (metallic and compounds), lead and lead compounds which are known to the state of California to cause cancer; and 1,3-butadiene, epichlorohydrin, di(2-ethylhexyl)phthalate, di-isodecyl phthalate, ethylene thiourea, methyl isobutyl ketone, methanol, toluene, lead and lead compounds which are known to the state of California to cause birth defects and other reproductive harm. For more information go to [www.P65Warnings.ca.gov](http://www.P65Warnings.ca.gov).

## What is leakage?

Leakage describes the unwanted loss, or leak of matter as it escapes its proper location. The matter may be liquid, gas or even solid in the form of powder for example.

It is a fact that every single seal on the planet has a measurable leakage rate. The leakage rate may be zero for some materials, such as liquid water or petroleum hydrocarbons with a relatively large molecular size, but will be more than zero for very small molecules such as helium or hydrogen gas. It is possible to manufacture a seal that has a leakage rate of  $1 \times 10^{-11}$  cc/sec/mm of helium. This is equivalent to the loss of a cubic centimeter of helium every 3000 years. It's an extremely low number but it is not the same as zero. Leakage is more properly thought of as a continuous spectrum of rates.

## Questions About Tooling

Parker is already tooled for a vast majority of standard sizes and cross sections. Sometimes it may be necessary to manufacture new tooling when the customer has special needs. The following guideline can help the customer understand when tooling may be necessary.

### There are two primary types of seal tooling. Roll form tooling and die form tooling.

**Roll form** tooling uses a series of rolls to make a particular cross section in any diameter needed. For example a 1/8" cross section C-ring roll form tooling can make a part that is 9.500" in diameter or 40.525" in diameter.

There is virtually no limitation on how large of a diameter can be roll formed. There are practical guidelines in the catalog pages however from a handling point of view, too small of a cross section with too large of a diameter may be difficult to handle without bending.

The diameter of the roll form also limits the lower end of the diameter. It is not possible to roll form a part with a smaller diameter than the diameter of the roll form. This catalog lists those guidelines as well.

**Die form** tooling makes one size diameter and one cross section. C-ring tooling that makes Internal pressure C-rings with a cross section of 1/8" and a diameter of 1.500" cannot be used to make any other diameter.

### C-seal (face seals - ECI, ECE, ESI and ESE)

C-rings under six inches are primarily die formed. This design guide lists the die sizes currently available. If an application requires a diameter not found on the list, then tooling may have to be made.

C-rings larger than six inches are primarily roll formed. All the standard cross section sizes have roll form tooling already made.

### C-seal (axial seals – ECA and ESA)

Axial C-rings require very tight tolerances. All axial C-rings are made using die form tooling. Available tooling sizes are listed on page E-91. If the required seal size is not listed then tooling will have to be manufactured.

### E-seal (face seals - EEI and EEE )

E-seals are manufactured using a series of roll forms. The number of roll stages depends on the number of the convolutions and the complexity of the cross section. This number can range from four to as many as 25 roll stages.

Parker has designed over 60 different cross sections as of the date of this catalog. This design guide lists only six cross sections as standard cross sections on pages C-24 to C-27. Some of the additional designs may be found on page F-98. E-seal applications tend to be unique and challenging, requiring careful selection to fit the appropriate cross section.

### U-seals (face seals – EUI and EUE)

U-seals are manufactured using a series of roll forms. They are simpler in nature than E-seals.

### O-rings (face seals EOI, EON, EOP, EOE, EOM and EOR)

O-rings are manufactured by winding tubing around an arbor. Parker has all of the tooling necessary to make any size.

### Wire rings (face seals – EWI and EWE)

Wire rings are manufactured by winding wire around an arbor. Parker has all of the tooling necessary to make any size.

#### WARNING

These products can expose you to chemicals including carbon black (airborne and extracts), antimony trioxide, titanium dioxide, silica (crystalline), di(2-ethylhexyl)phthalate, ethylene thiourea, acrylonitrile, 1,3-butadiene, epichlorohydrin, toluene diisocyanate, tetrafluoroethylene, ethylbenzene, formaldehyde, furfuryl alcohol, glass fibers, methyl isobutyl ketone, nickel (metallic and compounds), lead and lead compounds which are known to the state of California to cause cancer; and 1,3-butadiene, epichlorohydrin, di(2-ethylhexyl)phthalate, di-isodecyl phthalate, ethylene thiourea, methyl isobutyl ketone, methanol, toluene, lead and lead compounds which are known to the state of California to cause birth defects and other reproductive harm. For more information go to [www.P65Warnings.ca.gov](http://www.P65Warnings.ca.gov).



## Frequently Asked Questions

### How to troubleshoot a seal

It must be understood that a seal is only one component of the hardware necessary to contain the medium leaking. Seals are placed against flanges or shafts /bores and that hardware is just as important to prevent the loss of medium as the seal. The seal must be properly matched with appropriate hardware. Together they function as a team, and an issue with either part may cause the customer to experience more leakage than desired.

If a customer is experiencing an issue with leakage then there are several questions that must be addressed.

#### 1) What is the expectation for leakage?

As written above this might be zero for some applications, but it also may be a specific number for others. A customer may not want to see a pool of oil under machinery and the expectation may be zero leakage of oil. If, however, the customer is trying to contain air from leaking from one part of a jet engine to another part, there may be a measured amount that is allowed.

#### 2) Has the seal type been properly selected for the application?

Different types of seals have different abilities. Some applications require a seal with a low load and high amounts of springback. Some seals have very high seating load and it may not be possible to bolt the hardware down. Some types of seals do not have enough springback for certain applications.

#### 3) Has the seal been properly sized for the application?

Metal seals are less forgiving of sizing error than polymer seals. The seal needs to be correctly sized by taking into account:

- a. Cavity depth
- b. Cavity dimension tolerances
- c. The amount of flange separation that the application may experience

#### 4) Has the correct seal material been chosen for the application?

Proper material selection is critical. Materials must be selected for stress relaxation at temperature. Some materials are more appropriate than others for corrosion resistance, fatigue strength and chemical compatibility.

#### 5) Has the customer hardware been examined?

- a. Is the surface finish appropriate for the level of leakage desired? For example, is the customer using a circular lay face seal groove?
- b. Is the hardware tolerance understood and accounted for?
- c. Is there enough seating load for the seal? For example, are there enough bolts to compress the seal and are they the right size and grade?
- d. Do the customer flanges have the correct hardness? For example, seals with a seating load of 200 lbf/inch requires mating surface hardness of at least 35 Rc.
- e. Are there radial scratches or digs in the flange sealing surface?

#### 6) Has the seal been examined?

- a. Does the seal show signs of abuse or mishandling?
- b. Are radial scratches visible on the sealing surface?
- c. Has the seal been compressed to the proper cavity depth? Seals such as C-rings operate in the plastic region of the material and will take a set. When measured the seal should show that it has been compressed and the amount of springback should be taken into account.
- d. Is there a visible footprint where the seal made contact with the flange hardware? Is this footprint continuous? Does the footprint look the same on all parts of the seal that come into contact with the hardware?
- e. Was the seal properly sized? Has the seal diameter been measured?

# Application Data Sheet *Please photocopy for future use!*

		<h2>Face Seal</h2>			Date _____	
<b>Customer</b>	Company			Phone		
	Address			Fax		
	City	St.	Zip	E-Mail		
	Contact			Title		
<b>Operating Conditions</b>	Application/Equipment					
	Existing Seal			Customer Part Number		
	Clamping Load Available			Surface Finish		
	<input type="checkbox"/> Internal Pressure <input type="checkbox"/> External Pressure <input type="checkbox"/> Cyclic			Frequency _____		
	<input type="checkbox"/> Static			Amplitude _____		
	Fluid Medium			Cavity Materials		
	Maximum Allowable Leakage					
	Additional Information					
		(state all units)	At Assembly	Minimum	Maximum	Operating
	Temperature					
Pressure						
Cavity Depth "F" (± Tol.)						
Cavity Width "G" (± Tol.)						
O.D. "D" (± Tol.) Internal Pressure						
I.D. "D" (± Tol.) External Pressure						
<b>Sketch of Application</b>	<div style="border: 1px solid black; width: 100%; height: 100%; background-color: #f0f0f0;"> <!-- Grid for sketch --> </div>					
	<div style="border: 1px solid black; width: 100%; height: 100%; background-color: #f0f0f0;"> <!-- Grid for sketch --> </div>					
	<div style="border: 1px solid black; width: 100%; height: 100%; background-color: #f0f0f0;"> <!-- Grid for sketch --> </div>					
	<div style="border: 1px solid black; width: 100%; height: 100%; background-color: #f0f0f0;"> <!-- Grid for sketch --> </div>					
	<div style="border: 1px solid black; width: 100%; height: 100%; background-color: #f0f0f0;"> <!-- Grid for sketch --> </div>					
	<div style="border: 1px solid black; width: 100%; height: 100%; background-color: #f0f0f0;"> <!-- Grid for sketch --> </div>					
	<div style="border: 1px solid black; width: 100%; height: 100%; background-color: #f0f0f0;"> <!-- Grid for sketch --> </div>					
	<div style="border: 1px solid black; width: 100%; height: 100%; background-color: #f0f0f0;"> <!-- Grid for sketch --> </div>					
	<div style="border: 1px solid black; width: 100%; height: 100%; background-color: #f0f0f0;"> <!-- Grid for sketch --> </div>					
	<div style="border: 1px solid black; width: 100%; height: 100%; background-color: #f0f0f0;"> <!-- Grid for sketch --> </div>					
<b>Eng. Action</b>	Quotation Quantities			Annual Quantity Potential		

Section F  
Additional Metal Seal Styles



# Application Data Sheet *Please photocopy for future use!*

		<h2 style="margin: 0;">Axial Seal</h2>			Date _____
		Company _____		Phone _____	
Customer	Address _____			Fax _____	
	City _____	St. _____	Zip _____	E-Mail _____	
	Contact _____			Title _____	
	Application/Equipment _____				
Operating Conditions	Existing Seal _____			Customer Part Number _____	
	Insertion/Friction Force Limitations				
	<input type="checkbox"/> Static <input type="checkbox"/> Rotating <input type="checkbox"/> Reciprocating <input type="checkbox"/> Oscillatory				
	RPM _____		Stroke Length _____		Rotation _____
	Velocity _____			Velocity _____	
	Cycle Rate _____			Cycle Rate _____	
	Fluid Medium _____			Cavity Materials _____	
	Maximum Allowable Leakage _____				
	Additional Information _____				
	(state all units)      At Assembly      Minimum      Maximum      Operating				
Temperature					
Pressure					
Cavity O.D. "A" (± Tol.)					
Cavity I.D. "B" (± Tol.)					
Cavity Length "G" (± Tol.)					
Sketch of Application	<div style="border: 1px solid black; width: 100%; height: 100%; background-color: #f0f0f0;"> <!-- Grid representation of the sketch area --> </div>				
	Quotation Quantities _____			Annual Quantity Potential _____	



# Offer of Sale

The items described in this document and other documents and descriptions provided by Parker Hannifin Corporation, its subsidiaries and its authorized distributors ("Seller") are hereby offered for sale at prices to be established by Seller. This offer and its acceptance by any customer ("Buyer") shall be governed by all of the following Terms and Conditions. Buyer's order for any item described in its document, when communicated to Seller verbally, or in writing, shall constitute acceptance of this offer. All goods or work described will be referred to as "Products".

**1. Terms and Conditions.** Seller's willingness to offer Products, or accept an order for Products, to or from Buyer is expressly conditioned on Buyer's assent to these Terms and Conditions and to the terms and conditions found on-line at [www.parker.com/saleterms/](http://www.parker.com/saleterms/). Seller objects to any contrary or additional term or condition of Buyer's order or any other document issued by Buyer.

**2. Price Adjustments; Payments.** Prices stated on the reverse side or preceding pages of this document are valid for 30 days. After 30 days, Seller may change prices to reflect any increase in its costs resulting from state, federal or local legislation, price increases from its suppliers, or any change in the rate, charge, or classification of any carrier. The prices stated on the reverse or preceding pages of this document do not include any sales, use, or other taxes unless so stated specifically. Unless otherwise specified by Seller, all prices are F.O.B. Seller's facility, and payment is due 30 days from the date of invoice. After 30 days, Buyer shall pay interest on any unpaid invoices at the rate of 1.5% per month or the maximum allowable rate under applicable law.

**3. Delivery Dates; Title and Risk; Shipment.** All delivery dates are approximate and Seller shall not be responsible for any damages resulting from any delay. Regardless of the manner of shipment, title to any products and risk of loss or damage shall pass to Buyer upon tender to the carrier at Seller's facility (i.e., when it's on the truck, it's yours). Unless otherwise stated, Seller may exercise its judgment in choosing the carrier and means of delivery. No deferment of shipment at Buyers' request beyond the respective dates indicated will be made except on terms that will indemnify, defend and hold Seller harmless against all loss and additional expense. Buyer shall be responsible for any additional shipping charges incurred by Seller due to Buyer's changes in shipping, product specifications or in accordance with Section 13, herein.

**4. Warranty.** Seller warrants that the Products sold hereunder shall be free from defects in material or workmanship for a period of twelve months from the date of delivery to Buyer or 2,000 hours of normal use, whichever occurs first. This warranty is made only to Buyer and does not extend to anyone to whom Products are sold after purchased from Seller. The prices charged for Seller's products are based upon the exclusive limited warranty stated above, and upon the following disclaimer: Disclaimer of Warranty: This warranty comprises the sole and entire warranty pertaining to products provided hereunder. SELLER DISCLAIMS ALL OTHER WARRANTIES, EXPRESS AND IMPLIED, INCLUDING MERCHANTABILITY AND FITNESS FOR A PARTICULAR PURPOSE.

**5. Claims; Commencement of Actions.** Buyer shall promptly inspect all Products upon delivery. No claims for shortages will be allowed unless reported to the Seller within 10 days of delivery. No other claims against Seller will be allowed unless asserted in writing within 60 days after delivery or, in the case of an alleged breach of warranty, within 30 days after the date within the warranty period on which the defect is or should have been discovered by Buyer. Any action based upon breach of this agreement or upon any other claim arising out of this sale (other than an action by Seller for any amount due to Seller from Buyer) must be commenced within thirteen months from the date of tender of delivery by Seller or, for a cause of action based upon an alleged breach of warranty, within thirteen months from the date within the warranty period on which the defect is or should have been discovered by Buyer.

**6. LIMITATION OF LIABILITY.** UPON NOTIFICATION, SELLER WILL, AT ITS OPTION, REPAIR OR REPLACE A DEFECTIVE PRODUCT, OR REFUND THE PURCHASE PRICE. IN NO EVENT SHALL SELLER BE LIABLE TO BUYER FOR ANY SPECIAL, INDIRECT, INCIDENTAL OR CONSEQUENTIAL DAMAGES ARISING OUT OF, OR AS THE RESULT OF, THE SALE, DELIVERY, NON-DELIVERY, SERVICING, USE OR LOSS OF USE OF THE PRODUCTS OR ANY PART THEREOF, OR FOR ANY CHARGES OR EXPENSES OF ANY NATURE INCURRED WITHOUT SELLER'S WRITTEN CONSENT, EVEN IF SELLER HAS BEEN NEGLIGENT, WHETHER IN CONTRACT, TORT OR OTHER LEGAL THEORY. IN NO EVENT SHALL SELLER'S LIABILITY UNDER ANY CLAIM MADE BY BUYER EXCEED THE PURCHASE PRICE OF THE PRODUCTS.

**7. Contingencies.** Seller shall not be liable for any default or delay in performance if caused by circumstances beyond the reasonable control of Seller.

**8. User Responsibility.** The user, through its own analysis and testing, is solely responsible for making the final selection of the system and Product and assuring that all performance, endurance, maintenance, safety and warning requirements of the application are met. The user must analyze all aspects of the application and follow applicable industry standards and Product information. If Seller provides Product or system options, the user is responsible for determining that such data and specifications are suitable and sufficient for all applications and reasonably foreseeable uses of the Products or systems.

**9. Loss to Buyer's Property.** Any designs, tools, patterns, materials, drawings, confidential information or equipment furnished by Buyer or any other items which become Buyer's property, may be considered obsolete and may be destroyed by Seller after two consecutive years have elapsed without Buyer placing an order for the items which are manufactured using such property. Seller shall not be responsible for any loss or damage to such property while it is in Seller's possession or control.

**10. Special Tooling.** A tooling charge may be imposed for any special tooling, including without limitation, dies, fixtures, molds and patterns, acquired to manufacture Products. Such special tooling shall be and remain Seller's property notwithstanding payment of any charges by Buyer. In no event will Buyer acquire any interest in apparatus belonging to Seller which is utilized in the manufacture of the Products, even if such apparatus has been specially converted or adapted for such manufacture and notwithstanding any charges paid by Buyer. Unless otherwise agreed, Seller shall have the right to alter, discard or otherwise dispose of any special tooling or other property in its sole discretion at any time.

**11. Buyer's Obligation; Rights of Seller.** To secure payment of all sums due or otherwise, Seller shall retain a security interest in the goods delivered and this agreement shall be deemed a Security Agreement under the Uniform Commercial Code. Buyer authorizes Seller as its attorney to execute and file on Buyer's behalf all documents Seller deems necessary to perfect its security interest. Seller shall have a security interest in, and lien upon, any property of Buyer in Seller's possession as security for the payment of any amounts owed to Seller by Buyer.

**12. Improper use and Indemnity.** Buyer shall indemnify, defend, and hold Seller harmless from any claim, liability, damages, lawsuits, and costs (including attorney fees), whether for personal injury, property damage, patent, trademark or copyright infringement or any other claim, brought by or incurred by Buyer, Buyer's employees, or any other person, arising out of: (a) improper selection, improper application or other misuse of Products purchased by Buyer from Seller; (b) any act or omission, negligent or otherwise, of Buyer; (c) Seller's use of patterns, plans, drawings, or specifications furnished by Buyer to manufacture Product; or (d) Buyer's failure to comply with these terms and conditions. Seller shall not indemnify Buyer under any circumstance except as otherwise provided.

**13. Cancellations and Changes.** Orders shall not be subject to cancellation or change by Buyer for any reason, except with Seller's written consent and upon terms that will indemnify, defend and hold Seller harmless against all direct, incidental and consequential loss or damage. Seller may change product features, specifications, designs and availability with notice to Buyer.

**14. Limitation on Assignment.** Buyer may not assign its rights or obligations under this agreement without the prior written consent of Seller.

**15. Entire Agreement.** This agreement contains the entire agreement between the Buyer and Seller and constitutes the final, complete and exclusive expression of the terms of the agreement. All prior or contemporaneous written or oral agreements or negotiations with respect to the subject matter are herein merged.

**16. Waiver and Severability.** Failure to enforce any provision of this agreement will not waive that provision nor will any such failure prejudice Seller's right to enforce that provision in the future. Invalidation of any provision of this agreement by legislation or other rule of law shall not invalidate any other provision herein. The remaining provisions of this agreement will remain in full force and effect.

**17. Termination.** This agreement may be terminated by Seller for any reason and at any time by giving Buyer thirty (30) days written notice of termination. In addition, Seller may by written notice immediately terminate this agreement for the following: (a) Buyer commits a breach of any provision of this agreement (b) the appointment of a trustee, receiver or custodian for all or any part of Buyer's property (c) the filing of a petition for relief in bankruptcy of the other Party on its own behalf, or by a third party (d) an assignment for the benefit of creditors, or (e) the dissolution or liquidation of the Buyer.

**18. Governing Law.** This agreement and the sale and delivery of all Products hereunder shall be deemed to have taken place in and shall be governed and construed in accordance with the laws of the State of Ohio, as applicable to contracts executed and wholly performed therein and without regard to conflicts of laws principles. Buyer irrevocably agrees and consents to the exclusive jurisdiction and venue of the courts of Cuyahoga County, Ohio with respect to any dispute, controversy or claim arising out of or relating to this agreement. Disputes between the parties shall not be settled by arbitration unless, after a dispute has arisen, both parties expressly agree in writing to arbitrate the dispute.

**19. Indemnity for Infringement of Intellectual Property Rights.** Seller shall have no liability for infringement of any patents, trademarks, copyrights, trade dress, trade secrets or similar rights except as provided in this Section. Seller will defend and indemnify Buyer against allegations of infringement of U.S. patents, U.S. trademarks, copyrights, trade dress and trade secrets ("Intellectual Property Rights"). Seller will defend at its expense and will pay the cost of any settlement or damages awarded in an action brought against Buyer based on an allegation that a Product sold pursuant to this Agreement infringes the Intellectual Property Rights of a third party. Seller's obligation to defend and indemnify Buyer is contingent on Buyer notifying Seller within ten (10) days after Buyer becomes aware of such allegations of infringement, and Seller having sole control over the defense of any allegations or actions including all negotiations for settlement or compromise. If a Product is subject to a claim that it infringes the Intellectual Property Rights of a third party, Seller may, at its sole expense and option, procure for Buyer the right to continue using the Product, replace or modify the Product so as to make it noninfringing, or offer to accept return of the Product and return the purchase price less a reasonable allowance for depreciation. Notwithstanding the foregoing, Seller shall have no liability for claims of infringement based on information provided by Buyer, or directed to Products delivered hereunder for which the designs are specified in whole or part by Buyer, or infringements resulting from the modification, combination or use in a system of any Product sold hereunder. The foregoing provisions of this Section shall constitute Seller's sole and exclusive liability and Buyer's sole and exclusive remedy for infringement of Intellectual Property Rights.

**20. Taxes.** Unless otherwise indicated, all prices and charges are exclusive of excise, sales, use, property, occupational or like taxes which may be imposed by any taxing authority upon the manufacture, sale or delivery of Products.

**21. Equal Opportunity Clause.** For the performance of government contracts and where dollar value of the Products exceed \$10,000, the equal employment opportunity clauses in Executive Order 11246, VEVRAA, and 41 C.F.R. §§ 60-1.4(a), 60-741.5(a), and 60-250.4, are hereby incorporated.



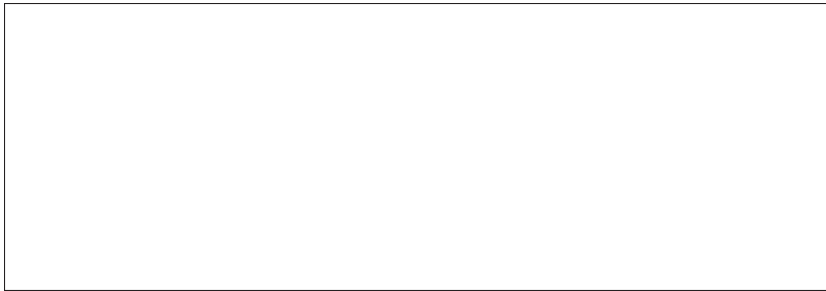

Your Local Authorized Parker Distributor



Parker Hannifin Corporation  
**Composite Sealing Systems Division**  
Advanced Products Business Unit  
33 Defco Park Road  
North Haven, CT 06473  
phone 203 239 3341  
fax 203 239 4409  
[www.parker.com](http://www.parker.com)