



Klozure® Radial Lip Seals and Bearing Isolator Technical Manual

Garlock
SEALING TECHNOLOGIES®

an EnPro Industries company

INTRODUCTION

Klozure® is the leading manufacturer of bearing protection devices for the heavy duty industrial market. Our broad product line includes radial lip seals, non-contact labyrinth bearing isolators, and mechanical seals.

Klozure® is a global company with installations worldwide, solving demanding applications big and small. We believe the best way to service the end user is through our strategic alliances with distribution partners. Our distribution partners are, ultimately, the quickest

way to constantly introduce new and innovative products at higher levels of performance and quality - products that will last longer and reduce overall maintenance costs.

With every Klozure® Seal, you can depend on receiving the backing of every Klozure® team member and their “can do” attitude, high-quality workmanship, and outstanding pride in a job done right. No matter what your difficult application may be, you can rest assured that Klozure® has a solution!

TECHNICAL MANUAL - HOW TO USE

The Klozure® Technical Manual is designed to facilitate product selection and to give you the most complete and relevant technical information you can find.

Our product information is organized by product type, with sections for Large Bore, Small Bore, Split, Excluder, External and Specialty type oil seals, as well as our extensive Bearing Isolator family of non-contact seals.

The General Engineering section is designed to offer technical guidance for equipment size and tolerances as well as operational parameters...all the information that will help specify the most effective technology for your application. This section also includes installation instructions with detailed diagrams along with information on troubleshooting and failure analysis...all to help the user install the Klozure® product and solve any potential problems.

GENERAL SEAL SELECTION

Single Lip Seals are ideal for the majority of sealing applications. These general purpose seals are available in a wide range of stock sizes.

Split KLOZURE® Oil Seals are designed for easy installation on large shafts without costly equipment teardown for seal replacement.

Dual Lip Oil Seals are recommended for applications requiring the protection from ingress and egress of material, the exclusion of abrasive or foreign materials, and difficult or unusual sealing challenges.

Bonded Oil Seals are used in applications where low cost and minimum performance are the primary considerations.

Special Purpose Oil Seals are recommended for high speed applications, reciprocating service, spherical bearings, tapered roller bearings and/or high pressure applications.

GUARDIAN™, MICRO-TEC II®, ISO-GARD® and EQUALIZER® Bearing Isolators provide superior bearing protection where outstanding contaminant exclusion and ultra long life are desired.

The technical manual contains the most concise, current sealing information to make seal selection easy and accurate, providing reference to applications, shaft speeds, operating temperatures and shaft size. This information permits you to select any Klozure® seal for long-lasting, trouble-free service. For online selection, visit: www.klozure.com

For non-standard applications, please complete an online application data sheet, or contact Klozure® for engineering assistance.

KLOZURE WARRANTY

All merchandise ordered shall be sold subject to SELLER'S standard warranty, viz: SELLER warrants that any product of its manufacture, which upon examination is found by a SELLER'S representative to be defective either in workmanship or material whereby it is not suitable under proper usage and service for the purpose for which designed, will be, at SELLER'S option, repaired or replaced free of charge including transportation charges but not cost of installation providing that SELLER receives written claim specifying the defect within one year after SELLER ships the product. ALL OTHER WARRANTIES EXPRESSED OR IMPLIED INCLUDING ANY WARRANTY

OF MERCHANTABILITY ARE HEREBY DISCLAIMED. The foregoing expresses all of SELLER'S obligations and liabilities with respect to the quality of items furnished by it and it shall under no circumstances be liable for consequential damages.



an EnPro Industries company

TABLE OF CONTENTS

Technology Overview	1
Engineering Data	2
Installation of Oil Seals & Bearing Isolators	8
Seal & Material Selection Guides	12
Oil Seal Configurations.....	13
Oil Seal Products	14
Bearing Isolator Configurations	23
Bearing Isolator Products.....	25
Glossary	29
Appendix A – Product Identification.....	31
Appendix B – Obsolete Oil Seal Model Number to Part Number Conversions	40
Appendix C – Chemical Compatibility.....	45
Appendix D – Damage Analysis.....	51
Appendix E – Application Data Sheets.....	55
Appendix F – Surface Speed Chart.....	57

Introduction

When up-time is critical, trust Klozure®. Each Klozure® oil seal and bearing isolator has been engineered to ensure the longest life and highest performance for the most demanding applications on the planet!



Oil Seals

At the heart of every Klozure® oil seal you will find the MILL-RIGHT® family of materials. Each of the new MILL-RIGHT® elastomers has been specifically engineered to provide the highest abrasion resistance, lowest wear, and exceptional chemical and temperature resistance. The engineered MILL-RIGHT® materials and seal designs, together, create the most advanced sealing solutions available in the heavy industrial market. With every Klozure® oil seal, you can depend on longer bearing life, increased productivity and less maintenance.

To ensure that you are receiving a genuine Klozure® oil seal with engineered MILL-RIGHT® materials, each MILL-RIGHT® material is color-coded for easy identification:

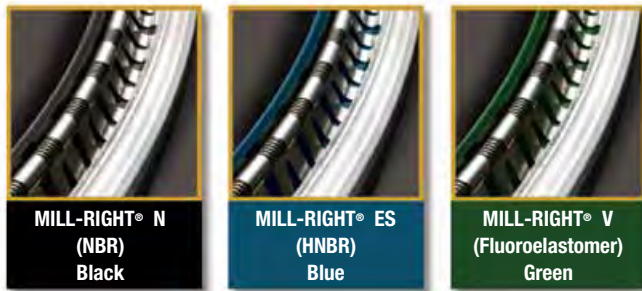

Engineering — MILL-RIGHT®

Klozure® takes great pride in our materials engineering capability. Every day we are thinking about what can be done differently to enhance our industry leading materials. The launch of the MILL-RIGHT® Family of Materials is proof of our continued success and advancement in materials engineering.

All radial lip seals are contact seals; the elastomer of the seal contacts the rotating element of the equipment. As such, the elastomer of the seal will wear away over time. Although the wearing of the elastomer can never be avoided, the elastomer can be engineered to minimize the amount of wear and thus improve the life of the seal. The amount of wear and abrasion resistance is crucial to end users as it reflects the quality of the seal and therefore equipment uptime.

Bearing Isolators

When superior bearing protection is what you need for your pumps, motors, gear boxes and other rotating equipment, rely on the Klozure® family of bearing isolators. With their patented cam lock design and engineered unitizing ring, the GUARDIAN™ and MICRO-TEC® II provide superior protection in a broad range of environments. When a non-metallic isolator is what you need, look to the ISO-GARD®.

Taber Abrasion Resistance

When Klozure® engineered the MILL-RIGHT® Family of Materials, extra emphasis was placed on abrasion resistance. Since Klozure® already had the most advanced materials available in the heavy duty industrial market, we used our own materials as benchmarks for measuring improvement.

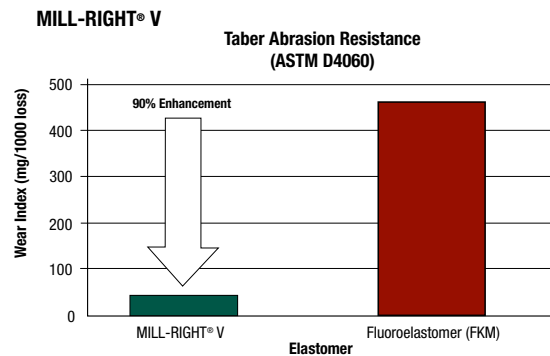
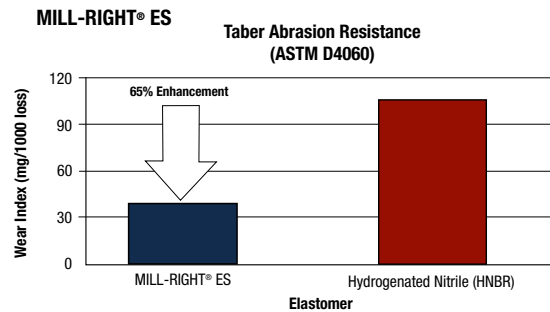
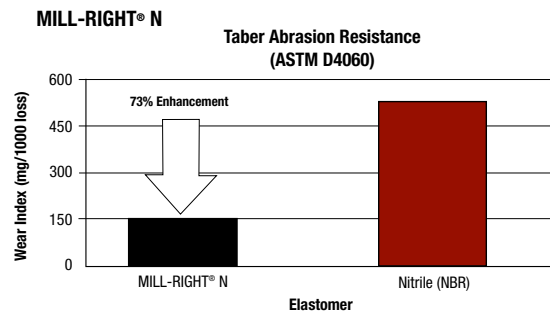

Whether you are buying an oil seal with engineered MILL-RIGHT® materials or one of the several bearing isolators offered, you can count on the Garlock Klozure® reputation for proven performance and added value.

Klozure®...Sealing Your Success!



General Specifications

The following general guidelines will help to provide the most robust, efficient and effective sealing system. While generally applicable, they cannot be interpreted to apply to each and every application. For specific application assistance please contact Klozure® Engineering.

Shaft Finish

The performance of an oil seal is related to the condition of the shaft surface in contact with the sealing member. Rough, poorly finished shafts, or shafts with turning or grinding spirals or “threads,” cannot be effectively sealed. New sealing surfaces are required for the replacement oil seal.

Unless otherwise specified, Klozure® recommends a minimum hardness of 30 Rockwell C. A shaft hardness of 45 Rockwell C will provide extra protection against damage during handling or assembly.

A plunge ground finish is the most satisfactory method for shafts and sleeves. Garlock Klozure® recommends 10-20 µ in. Ra (0.25-0.50 µm) with no machine lead, scratches, dents, corrosion, pits, or other surface defects.

Table 1 — Shaft Requirements

Seal Type	Required Shaft Hardness	Required Shaft Finish	
	Rockwell C	µin (microinches) Ra	µm (micrometers) Ra
Standard Oil Seals	30 min.	10 - 20	0.25 - 0.50
PS-I Oil Seals	50 min.	4 - 8	0.10 - 0.20
Bearing Isolators	Not Specified	64 maximum	1.63 maximum

Table 2 — Determination of Lead (Source: RMA Handbook OS-1/1985)

Thread Movement During Clockwise (CW) Rotation	Thread Movement During Counter-Clockwise (CCW) Rotation	Lead Definition
From Fixed End Towards Free End	From Free End Towards Fixed End	Clockwise Lead (Right-Hand) See Figure 1 and Figure 2
From Free End Towards Fixed End	From Fixed End Towards Free End	Counter-Clockwise Lead (Left-Hand) See Figure 3 and Figure 4
No Movement	No Movement	No Measurable Lead
From Fixed End Towards Free End	From Fixed End Towards Free End	Shaft may be tapered. Remount shaft end-for-end. If direction reverses, shaft is tapered.
From Free End Towards Fixed End	From Free End Towards Fixed End	Shaft may be tapered. Remount shaft end-for-end. If direction reverses, shaft is tapered.
From Fixed End Towards Free End	From Fixed End Towards Free End	Shaft may not be level. Remount shaft end-for-end. If direction does not reverse, shaft is not level.
From Free End Towards Fixed End	From Free End Towards Fixed End	Shaft may not be level. Remount shaft end-for-end. If direction does not reverse, shaft is not level.
Away From Center	Away From Center	Crowned Shaft
Toward Center	Toward Center	Cusped Shaft

Shaft Lead

Lead, or spiral grooves, can be generated on a shaft surface by the relative axial movement of the finishing tool (grinding wheel, belt, lathe, etc.) during the finishing operation. The lead on a shaft can adversely affect a radial lip seal, frequently causing severe leakage and seal failure.

Lead Detection

Since it is virtually impossible to manufacture totally lead-free surfaces, the widely used thread method allows lead to be detected and quantified. The procedure for performing this method is described below.

1. Mount the shaft or sleeve in a holding chuck.
2. Lightly coat the shaft or sleeve with a 5 to 10 cps viscosity silicone oil.
3. Check that the shaft or sleeve is level in the assembly. The most accurate results will be achieved when the setup is level.
4. Obtain a length of 100% extra strong quilting thread. A thread of diameter 0.009 inch (0.23mm) is recommended. Unwaxed dental floss may be substituted if necessary.
5. Drape thread over the surface of the shaft and attach a one ounce (28 g) weight at a distance below the shaft. This will create a string-to-shaft contact arc of 220° to 240°.
6. Adjust rotational speed of the machine to 60 RPM.
7. Measure the axial movement of the thread while the shaft or sleeve rotates for a period of 30 seconds.
8. Place the thread at both edges of the shaft as well, to observe for movement in these areas as well.
9. Reverse the direction of the shaft or sleeve rotation, and repeat test.
10. Compare results to Table 2 for interpretation of lead.

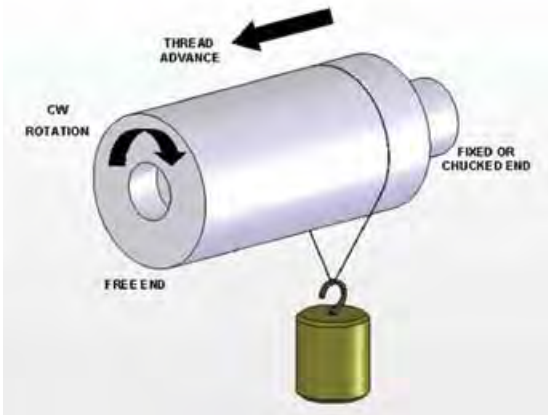

Figure 1 — Clockwise Lead

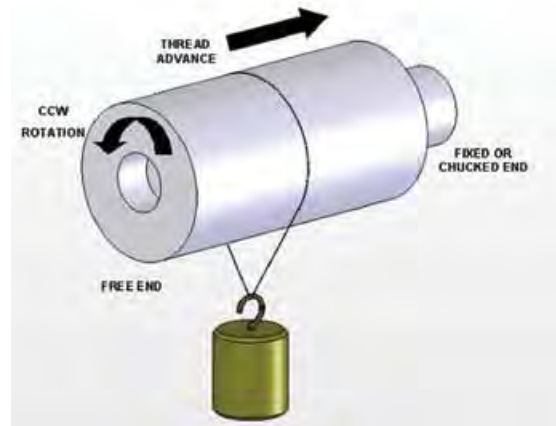

Figure 2 — Clockwise Lead

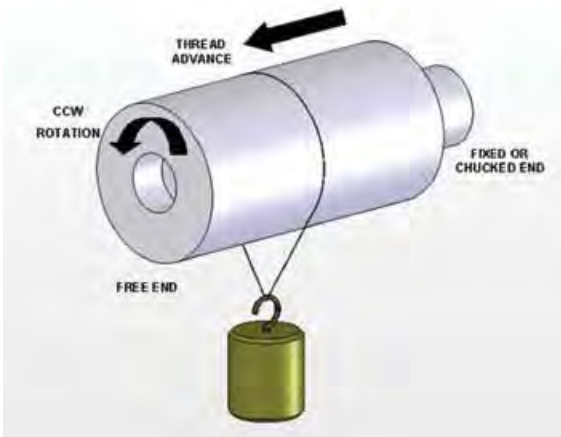

Figure 3 — Counter-Clockwise Lead

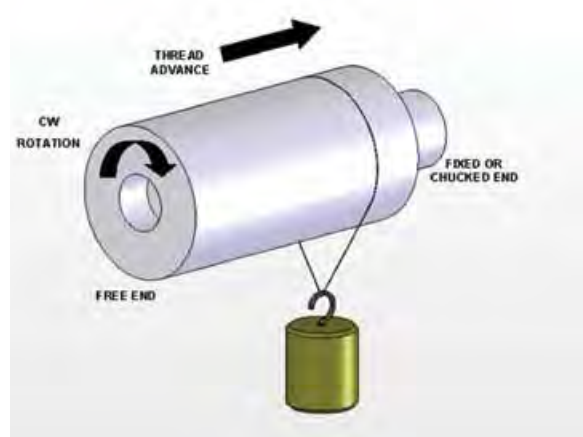

Figure 4 — Counter-Clockwise Lead

Comparing Shaft Lead – Lead Angle

The lead of a shaft can be compared with other shafts of differing diameters by calculating the lead angle. The lead angle is the angle whose tangent is found by dividing the string advance in inches by the product of the shaft circumference, also in inches, and the number of revolutions required to advance the string the measured amount.

$$\text{LEAD ANGLE} = \text{ARCTAN} * \frac{\text{String Advance}}{(\text{Shaft Circumference}) * (\text{Number of Turns})}$$

For example, a string will advance 0.300" in 30 seconds on a 4.000" shaft rotating at 60 RPM. The lead angle will equal $0.0456^\circ = 2' 44.1''$. A two-inch shaft with the same advance (0.300 inches in 30 seconds at 60 RPM) will have a lead angle of $0.0912^\circ = 5' 28.3''$.

For optimum seal performance, industry standard recommends that the lead angle of a shaft be $0^\circ \pm 0.05^\circ$ ($0' \pm 3''$).

Shaft-to Bore Misalignment

Shaft-to-bore misalignment is defined as the distance by which the shaft is off-center with respect to the bore. This can be simply measured as the distance between the shaft centerline and the bore centerline. See Figure 5.

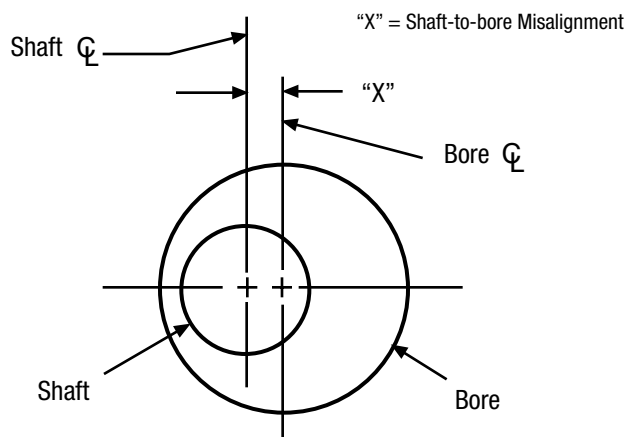

Figure 5 — Shaft-to-bore Misalignment

Dynamic Runout

Dynamic runout is defined as the amount by which the shaft (at the sealing surface) does not rotate around the true center. It is measured by the total movement of a dial indicator held against the shaft surface while the shaft is slowly rotated. This is read as total indicator reading, or TIR. See Figure 6.

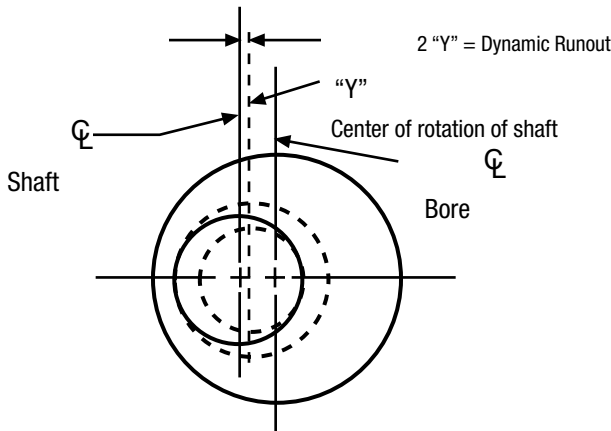

Figure 6 — Dynamic Runout

Pressure

Standard oil seals should not be used when the operating pressure exceeds the limits shown in Table 3.

When variable surge pressures exceeding the above limits are present, a special condition exists and full details should be submitted for engineering recommendation.

Higher operating pressures may be feasible if a custom seal is considered. However, when a pressure seal is used, features such as the ability to withstand greater eccentricities are sacrificed. Whenever possible, the equipment design should be such that the system is vented. This will allow the seal to function more effectively.

Table 3 — Operating Pressure Limits For Standard Oil Seals

Shaft Speed		Maximum Pressure* Based on Operating Speed		
f/m (feet per minute)	m/s (meters per second)	psi (pounds per sq.in)	kPa (kilopascals)	bar
0-1000	0-5.1	7	48	0.48
1001-2000	5.2-10.2	5	34	0.34
2001 & up	10.3 & up	3	21	0.21

* Split Klozure® Oil Seals are not recommended for applications involving fluid pressure.

Table 4 — Maximum Pressure Limits by Seal Type

Seal Type	Maximum Operating Pressure*		
	psi (pounds per sq. in)	kPa (kilopascals)	bar
Standard Oil Seals	7	48	0.48
PS-I Oil Seals	150†	1,034	10.34
Bearing Isolators	Ambient	Ambient	Ambient

* Maximum operating pressure decreases as surface speed increases. Please consult Klozure® Engineering for specific application operating pressures.

† Retaining plate required at pressures greater than 75psi.

Shaft and Bore Tolerances

Close tolerances in the finished dimensions of the shaft, in the bore of the housing, and in the oil seal itself are essential to satisfactory seal performance. See Table 5, 6 and 7 for recommended shaft and bore diameter tolerances.

Table 5 — Shaft Diameter Tolerances for Oil Seals

Shaft Diameter		Recommended Tolerance	
Inch	mm	Inch	mm
Up thru 4.000	Up thru 101.60	±0.003	±0.08
4.001 - 6.000	101.61-152.40	±0.004	±0.10
6.001-10.000	152.41-254.00	±0.005	±0.13
10.001 & Up	254.01 & Up	±0.006	±0.15

Table 6 gives the recommended bore diameter tolerances. These bore tolerances given apply only to housings made from ferrous materials. When non-ferrous materials such as aluminum are used, full details should be submitted for recommendation.

Bore depth (seal width) standard tolerance is ± 0.016" (0.4 mm).

Table 6 — Housing Bore Tolerances for Oil Seals

Housing Bore Diameter (Nominal)		Recommended Bore Diameter Tolerance	
Inch	mm	Inch	mm
Thru 1.000	Thru 25.40	±0.001	±0.03
1.001 - 3.000	25.41 - 76.20	±0.001	±0.03
3.001 - 4.000	76.21 - 101.60	±0.0015	±0.04
4.001 - 4.375	101.61 - 111.13	±0.0015	±0.04
4.376 - 6.000	111.14 - 152.40	±0.0015	±0.04
6.001 - 7.000	152.41 - 177.80	±0.002	±0.05
7.001 - 8.000	177.81 - 203.20	±0.002	±0.05
8.001 - 9.000	203.21 - 228.60	±0.002	±0.05
9.001 - 10.000	228.61 - 254.00	±0.002	±0.05
10.001 - 20.000	254.01 - 508.00	+0.002 -0.004	+0.05 -0.10
20.001 - 30.000	508.01 - 762.00	+0.002 -0.006	+0.05 -0.15
30.001 - 40.000	762.01 - 1016.00	+0.002 -0.006	+0.05 -0.15
40.001 - 60.000	1016.01 - 1524.00	+0.002 -0.010	+0.05 -0.25

Recommended Bore Finish = 100 microinches Ra (2.54 micrometers) or smoother.

Table 7 — Shaft and Bore Tolerances for Bearing Isolators

Shaft Diameter		Recommended Tolerance	
Inch	mm	Inch	mm
Thru 6.000	Thru 152.40	±0.002	±0.05
6.001 & Up	152.41 & Up	±0.003	±0.08

Bore Diameter		Recommended Tolerance	
Inch	mm	Inch	mm
Thru 6.000	Thru 152.40	±0.001	±0.03
6.001 - 10.000	152.41 - 254.00	±0.002	±0.05
10.001 & Up	254.01 & Up	±0.003	±0.08

Surface Speed

Safe operating speeds depend on shaft finish, misalignment and runout, type of lubricant, amount of lubricant, pressure, and seal design. As shaft speed increases, these factors become more critical.

The formula for determining surface speed for a particular application is listed below. Alternately, see Appendix E for the surface speed chart.

$$\text{Surface Speed (f/m)} = \text{ShaftDia(in)} * \text{RPM} * 0.262$$

$$\text{Surface Speed (f/m)} = \text{ShaftDia(mm)} * \text{RPM} * 0.0103$$

$$\text{Surface Speed (m/s)} = \text{ShaftDia(in)} * \text{RPM} * 0.0013299$$

$$\text{Surface Speed (m/s)} = \text{ShaftDia(mm)} * \text{RPM} * 0.0000524$$

Surface speed limits vary with seal design. Please refer to the product offerings for limits on specific Garlock Klozure® seals.

Table 8 — Conversion Formulas

Conversion Formulas		
Multiply	By	To Obtain
Inch (in)	25.4	millimeter (mm)
millimeter (mm)	0.0394	Inch (in)
bar	100	kilopascal (kPa)
bar	14.504	psi (lb/sq. in)
kilopascal (kPa)	0.010	bar
kilopascal (kPa)	0.145	psi (lb/sq. in)
psi (lb/sq. in)	0.0689	bar
psi (lb/sq. in)	6.895	kilopascal (kPa)

Table 9 — Temperature Conversion

Temperature Conversion Formulas
$^{\circ}\text{F} = 1.8 (^{\circ}\text{C}) + 32$
$^{\circ}\text{C} = (^{\circ}\text{F} - 32)/1.8$

* Important note *

The recommendations in this catalog as to shaft finishes, misalignment, runout, speeds, temperatures, and tolerances are those generally applicable, but they are not to be interpreted as applying, without reservation or exception, to each and every application. The model and type of seal selected for a given application, and other conditions surrounding that application, may modify these average limitations one way or the other. Therefore, it is desirable in most cases to provide full information to Klozure® and have our experienced staff of engineers submit a recommendation.

Nationally Recognized Standards

Many bearing isolator models conform to nationally accepted standards for operation including API, IEEE, and NEMA. A brief summary of these standards follows. Please see bearing isolator product information section for product-specific conformances.

API 610

API 610 is a standard for centrifugal pumps used in petroleum, heavy duty chemical and gas industry services. API standards are published by the American Petroleum Institute. Paragraph 5.10.2.7 of the API 610 standard indicates that bearing housings for rolling-element bearings should be designed to retain oil and prevent contamination. Acceptable sealing devices include replaceable labyrinth-type or magnetic-type end seals and deflectors. Lip-type seals are not acceptable. All seals and deflectors are to be made of non-sparking materials.

IEEE 841

IEEE (Institute of Electrical and Electronics Engineers) defines requirements for enclosures for the petroleum and chemical industries. Enclosures are defined as either Totally Enclosed Fan-Cooled (TEFC) or Totally Enclosed Non-Ventilated (TENV). Definitions are specified by IP ratings as per NEMA MG 1, part 5.

NEMA MG 1

NEMA (National Electrical Manufacturers Association) designates a degree of protection provided by enclosures for rotating electrical machines. It also designates the test procedures to determine if a machine meets the requirements. The IP rating designates two characteristic numeric identifiers of an enclosure's ability to protect against solid foreign objects and water ingress. The IP rating consists of the letters "IP" followed by two digits, the first applicable to protection against solid object ingress and the second to protection against water ingress.

All standard Klozure Bearing Isolators are specified for a rating of IP55 or IP56. The following defines the characteristic numerals for these ratings:

A first characteristic numeral of 5 indicates a dust protected machine. To verify conformance to this level a bearing isolator is installed in an enclosed environment. Talcum powder (sifted through a sieve with spacing of 75 μm) is agitated with a rotating fan. Vacuum is pulled through the seal for a minimum of 2 hours.

A second characteristic numeral of 5 indicates a machine protected against water jets. Conformance is verified by installing the bearing isolator in an enclosed environment and subjecting to spraying water from all practical directions at 11.9 – 13.2 liters/min (3.1 – 3.5 gpm) for 3 minutes at a minimum nozzle discharge pressure of 0.3 bar (4.4 psi).

A second characteristic numeral of 6 indicates a machine protected against heavy seas or powerful jets. Conformance is verified by installing the bearing isolator in an enclosed environment and subjecting to spraying water from all practical directions at 100 liters/min (26.4 gpm) ± 5% for 3 minutes at a minimum nozzle discharge pressure of 1 bar (14.5 psi).

Face-Type Excluder Seals

Face Seals, sometimes called “flinger seals” or “V-seals,” have a significantly different function than typical radial lip seals. While radial lip seals can be used either to retain fluid or exclude contaminants, face seals are solely excluders. The sealing lip engages the surface of the application housing rather than the shaft surface. The inside diameter is statically engaged on the shaft (see figure 7 below).

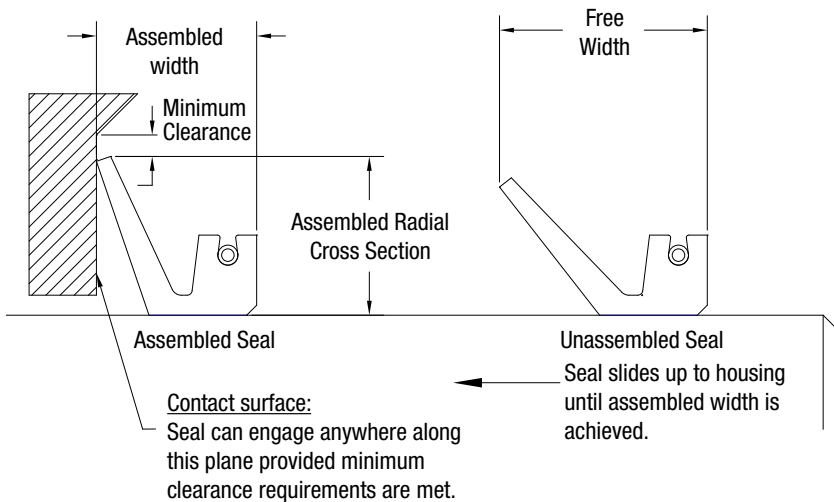

Figure 7

For smaller shaft sizes and lower speed applications the models 145A, 145L, and 145S are available as shown below. Each seal is specified by a range of shaft sizes that it will fit. Assembled radial cross-section and width increase with shaft size. Please consult Klozure Engineering for specific sizing information.

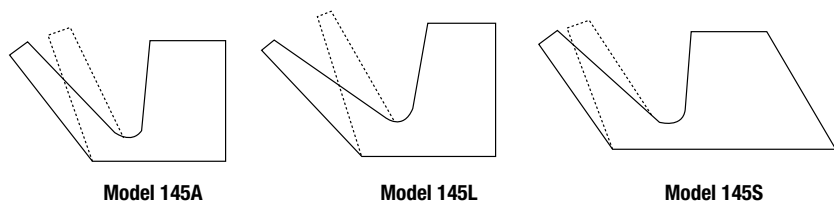

Figure 8

For larger shaft sizes and higher speeds the model 145A1 and 145A2 are available as shown to the right. Each seal is specified by a range of shaft sizes that it will fit. The assembled radial cross-section and width is consistent to each model regardless of shaft size.

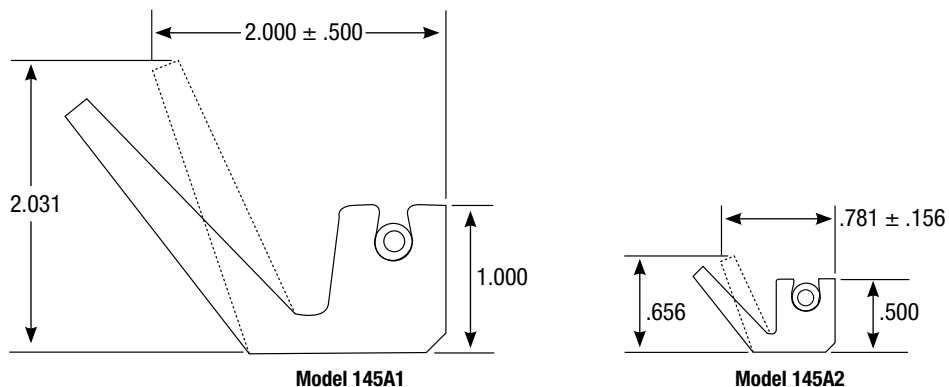

Figure 9

When a split-type excluder seal is desired choose from the model 143A1, 143A2, 144W1, or 144W2. Each seal is specified by a specific shaft x assembled OD x assembled width. The assembled radial cross-section and width is consistent to each model regardless of shaft size.

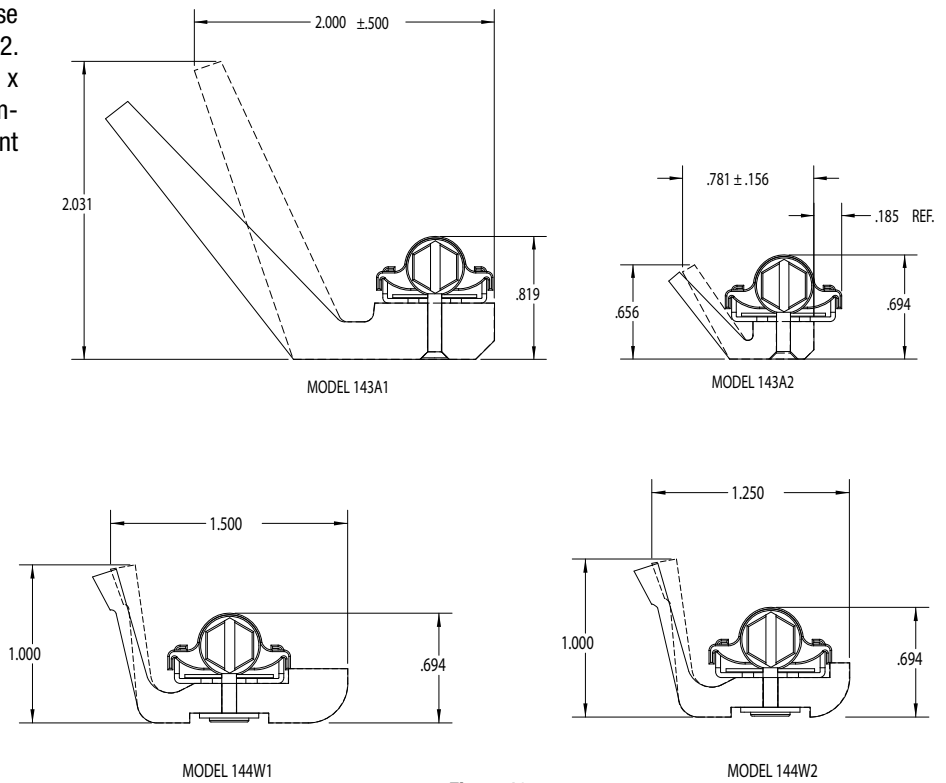

Figure 10

Dimensional Data for various model face seals is shown below:

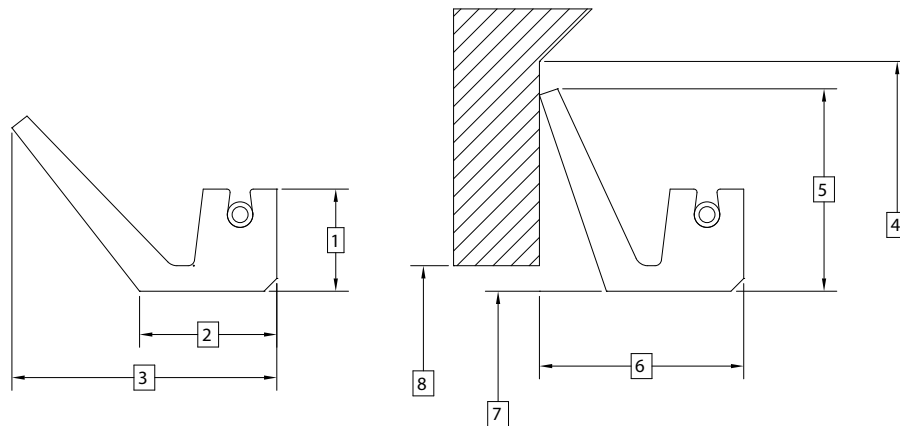

Figure 11

Table 10 — Dimensional Data

DIM #	Description	Model 143A1	Model 143A2	Model 144W1	Model 144W2	Model 145A1	Model 145A2
1	Heel / Clamp height	0.819" (20.8mm)	0.694" (17.6mm)	0.694" (17.6mm)	0.694" (17.6mm)	1.000" (25.4mm)	0.500" (12.7mm)
2	Shaft contact width	1.344" (34.1mm)	0.563" (14.3mm)	1.331" (33.8mm)	1.081" (27.5mm)	1.344" (34.1mm)	0.563" (14.3mm)
3	Overall free width	2.594 (65.9mm)	0.969" (24.6mm)	1.614" (41.0mm)	1.362" (34.6mm)	2.594" (65.9mm)	0.969" (24.6mm)
4	Minimum face diameter	Shaft + 4.500" (114.3mm)	Shaft + 1.750" (44.5mm)	Shaft + 2.438" (61.9mm)	Shaft + 2.438" (61.9mm)	Shaft + 4.500" (114.3mm)	Shaft + 1.750" (44.5mm)
5	Assembled x-section	2.031" (51.6mm)	0.656" (16.7mm)	1.000" (25.4mm)	1.000" (25.4mm)	2.031" (51.6mm)	0.656" (16.7mm)
6	Assembled width	2.000 ± 0.500" (50.8 ± 12.7mm)	0.781 ± 0.156" (19.8 ± 4.0mm)	1.500 ± 0.062" (38.1 ± 1.6mm)	1.250 ± 0.062" (31.8 ± 1.6mm)	2.000 ± 0.500" (50.8 ± 12.7mm)	0.781 ± 0.156" (19.8 ± 4.0mm)
7	Shaft diameter	Application Dependent	Application Dependent	Application Dependent	Application Dependent	Application Dependent	Application Dependent
8	Maximum face bore	Shaft + 1.000" (25.4mm)	Shaft + 0.391" (9.9mm)	Shaft + 1.000" (25.4mm)	Shaft + 1.000" (25.4mm)	Shaft + 1.000" (25.4mm)	Shaft + 0.391" (9.9mm)

Equipment Inspection and Preparation

Prior to the installation of any lip seal, all of the equipment must be thoroughly inspected. The following specifications are critical and must be maintained:

- **Shaft Surface Finish, Ra (Roughness Average or AA (Arithmetic Average))**
 For all seals, excluding the P/S® I (Model 61), the surface finish must be within 10-20µin. (0.25-0.50µm).
 For the P/S® I (Model 61), the surface finish must be within 4-8µin. (0.10-0.20µm).
 For all seals, the surface finish direction must be perpendicular to the shaft axis of rotation.
- **Bore Surface Finish, Ra (Roughness Average or AA (Arithmetic Average))**
 For all seals, the surface finish must be equal to or less than 100µin. (2.54µm).
 For all seals, the surface finish direction must be perpendicular to the shaft axis of rotation.
- **Shaft Surface Hardness**
 For all seals, excluding the P/S® I (Model 61), the surface hardness must be at least 30 Rockwell C.
 For the P/S® I (Model 61), the surface hardness must be at least 50 Rockwell C.
- Both the shaft and bore should include an edge relief (preferably an edge chamfer) as shown in Figure 12 & 13. See table 11 and 12 for specific values.

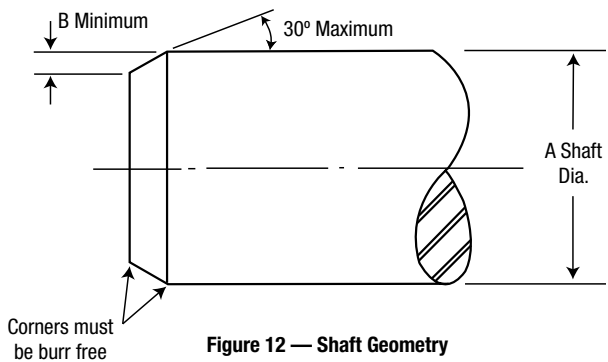

Figure 12 — Shaft Geometry

Table 11 — Edge Relief for Shafts

A - Shaft Diameter		B - Minimum*	
Inch	mm	Inch	mm
Thru 0.394	Thru 10.00	0.030	0.75
0.395 - 0.787	10.01 - 20.00	0.040	1.00
0.788 - 1.181	20.01 - 30.00	0.050	1.25
1.182 - 1.575	30.01 - 40.00	0.060	1.50
1.576 - 1.969	40.01 - 50.00	0.070	1.75
1.970 - 2.756	50.01 - 70.00	0.080	2.00
2.757 - 3.740	70.01 - 95.00	0.090	2.25
3.741 - 5.118	95.01 - 130.00	0.110	2.75
5.119 - 9.449	130.01 - 240.00	0.140	3.50
9.450 & Up	240.01 & Up	0.220	5.50

*If a shaft lead-in radius is used, maintain the diametral difference to no less than indicated value

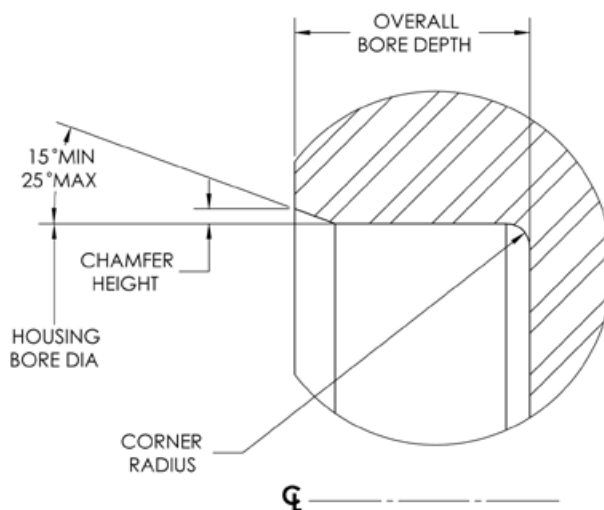

Figure 13 — Housing Bore Dimensions

Table 12 — Edge Relief for Housing Bores

Bore Diameter		Typical Seal Width		Chamfer Height		Max Corner Radius	
Inch	mm	Inch	mm	Inch	mm	Inch	mm
Thru 4.008	Thru 101.8	0.313 - 0.500	8.0 - 12.8	0.040 - 0.050	1.0 - 1.3	0.020	0.51
4.009 - 5.999	101.8 - 152.4	0.438 - 0.500	11.2 - 12.8	0.050 - 0.060	1.3 - 1.5	0.030	0.76
6.000 - 6.999	152.4 - 177.8	0.500 - 0.625	14.3 - 15.9	0.060 - 0.070	.5 - 1.8	0.030	0.76
7.000 - 7.999	177.8 - 203.2	0.500 - 0.750	12.8 - 19.1	0.060 - 0.080	1.5 - 2.0	0.030	0.76
8.000 - 8.999	203.2 - 228.6	0.625 - 0.875	15.9 - 22.3	0.070 - 0.090	1.8 - 2.3	0.030	0.76
9.000 - 9.999	228.6 - 254	0.625 - 0.875	15.9 - 22.3	0.070 - 0.090	1.8 - 2.3	0.030	0.76
10.000 - 19.999	254.0 - 507.9	0.625 - 1.000	15.9 - 25.5	0.070 - 0.120	1.8 - 3.0	0.040	1.02
20.000 - 29.999	508.0 - 761.9	0.688 - 1.250	17.5 - 31.9	0.080 - 0.130	2.0 - 3.3	0.040	1.02
30.000 - 39.999	762.0 - 1015.9	0.688 - 1.250	17.5 - 31.9	0.080 - 0.130	2.0 - 3.3	0.040	1.02
40.000 & Up	1016.0 & Up	0.688 - 1.250	17.5 - 31.9	0.080 - 0.130	2.0 - 3.3	0.040	1.02

NOTE: At least 2/3 of the seal width must be captured in the housing bore, not including chamfer

- The shaft and bore must be free of any type of defect. Examples of defects would be spiral-machining marks (also known as “machined lead”), burrs, sharp edges (corners), nicks, scratches, indentations, corrosion, etc.
- In most cases, the shaft will have a wear groove created from the previous seals. Care must be taken to ensure the new sealing lip does not seal in the same location.
- When drive features are present, such as a keyway or spline, the drive feature must be covered using an installation tool similar to the one shown in Figure 15, Installation Method D. If the size of the shaft prohibits such a tool, then the following may be used:
 - ❖ Polyethylene tape
 - ❖ Brass shim stock with smooth edges
 - ❖ Wooden plug with smooth edges

Seal Inspection

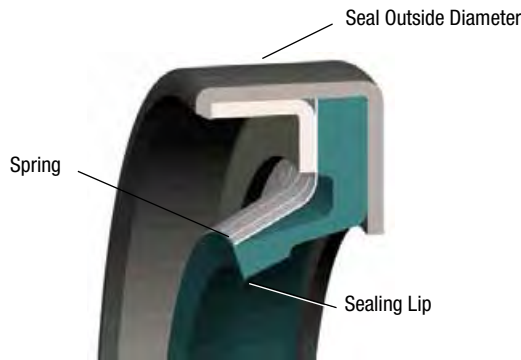
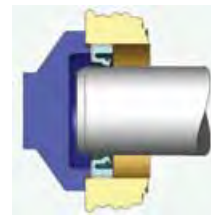

Figure 14 — Seal Cross Section

- Sealing Lip (Figure 14)
 - ❖ Inspect the sealing lip, looking for any signs of damage. Damage could be in the form of cuts, indentations, nicks, and/or off-register bonds.
 - ❖ Ensure that the spring (finger or garter type) is properly retained within the seal (bonded or assembled).
- Seal Outside Diameter (Figure 14)
 - ❖ Inspect the seal outside diameter, looking for any signs of damage. Damage could be in the form of indentations, scores, nicks, burrs, and/or cuts (for rubber OD seals).

Installation Methods



Installation Method A Thru Bore:
Installation tool bottoms on machined face

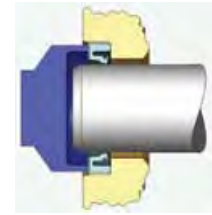

Installation Method B Blind Bore:
Seal bottoms on machined bore shoulder

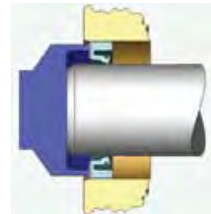

Installation Method C Thru Bore:
Installation tool bottoms on shaft

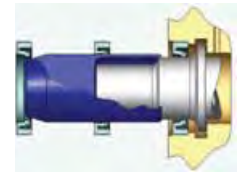

Installation Method D Thru Bore:
Mounting thimble assists in compressing seal lip for easier installation

Figure 15 — Installation Methods

Solid Seal Installation

Using Figure 15 installation methods, install the seal. For all installation tooling, the diameter (contact area) must not be more than 0.010” (0.254mm) smaller than the bore diameter. If the size of the seal prohibits such a tool, then:

- Use a wooden block (2x4 board or similar) and a mallet to lightly tap the seal into position (you must not strike the seal directly with the mallet as damage may occur). Follow a star pattern (see Figure 16) while tapping the seal into position to prevent “cocking” of the seal.

Place the ends of the board at positions 1 and 2.

- Strike the center of the board with the mallet.
- Rotate the board to the appropriate positions (3 and 4, 5 and 6, 7 and 8).

- Repeat the star pattern as necessary until the seal is fully seated in the housing bore. When the seal is fully seated, the distance from the top surface of the seal to the top controlled surface of the housing must be equal to or less than 0.010” (0.254mm).

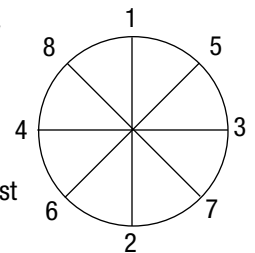

Figure 16 — Star Pattern

Split Seal Installation

(Ambient Pressure / Non-Flooded Applications Only)

- Using the application lubricant, apply a thin coating on the seal lip and the shaft.
- Split the seal along the axis of rotation, as shown below in Figure 17, and place the seal around the shaft.



Figure 17 — Split Seal Separation

- Starting with the split ends, insert the seal into the housing bore. Care must be taken to ensure the split ends of the seal are touching.
- Continue inserting the seal into the housing bore, working downward on both sides and finishing at the bottom.
- After the seal is fully seated in the housing bore, the seal should protrude from the surface of the housing by 0.015" (0.381mm), as shown in Figure 18.

* Important note *

The 0.015" protrusion will be built into the width of the seal. The depth of the bore housing should be machined to the seal width specified on the package.

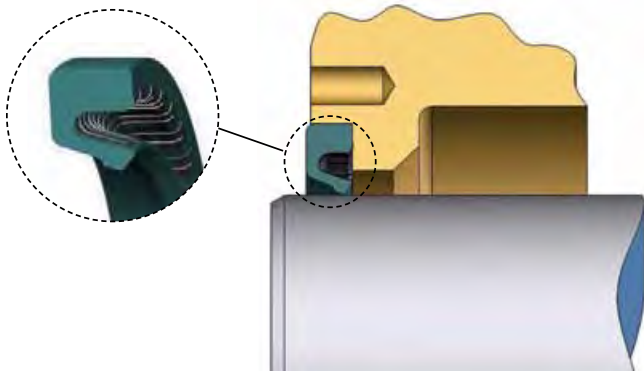
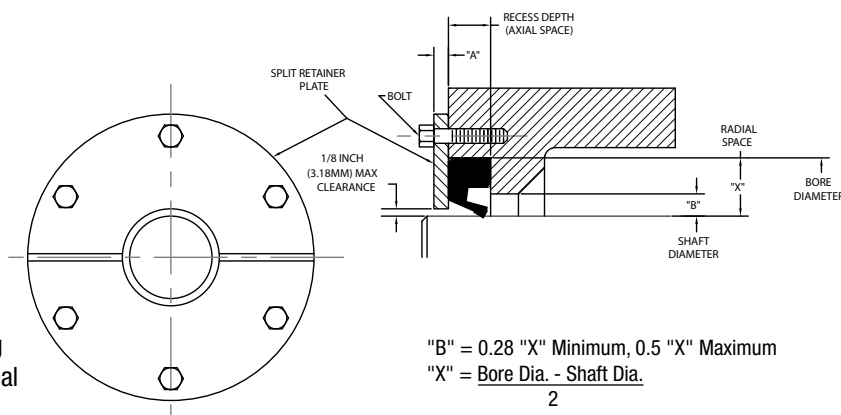

Figure 18 — Split Seal Installed

Table 13 — Split Seal Installation

Shaft Diameter	No. of Bolts	"A" Minimum Plate Thickness
3" - 8" (76.2 - 203.2 mm)	6	1/8" (3.18 mm)
Over 8"	Bolts on a max. of 6" (152.4 mm) chord, spacing centered about split in end plate	1/4" (6.35 mm)



*Figures shown are for a guide only. Good machine design practices should be followed.

Figure 19 — Standard Oil Seal Installation

Inspection

Once the seal has been installed, carefully inspect both sealing areas looking for leaks (pay close attention to the area around the sealing lip and the outside diameter of the seal). Also, confirm that the sealing lip is not in the wear groove of the previous seal.

Equipment Preparation

Prior to the installation of any isolator, all of the equipment must be thoroughly inspected. Disconnect all system power and follow all standard safety procedures throughout the installation of the isolator.

Check the shaft and bore surfaces. The shaft finish should be better than 64 μin (1.63 μm). Lead should be minimal, but a polished surface is not required. The bore surface must be equal to or less than 64 μin (1.63 μm). The shaft and bore should include an edge relief, such as a chamfer, to prevent shearing of the o-ring.

The shaft and bore must be free of any type of defect. This includes any burrs, nicks, sharp edges, indentations, scratches, etc. Clean all foreign debris from the area. In many cases, the shaft will have a wear groove from a previous lip seal. Care must be taken that the rotor o-ring does not ride in this area.

If drive features are present on the shaft, such as a keyway or spline, the drive feature must be covered during installation. This can be accomplished using an installation tool, polyethylene tape, brass shim stock with smooth edges, or a wooden plug with smooth edges.

Seal Preparation

Klozure[®] Guardian[™], MICRO-TEC[®] II, ISO-GARD[®], and Equalizer[®] bearing isolators are unitized. Any attempts to disassemble the seal will cause seal damage and void warranty.

Inspect the outer diameter and inner diameter o-rings. These o-rings should be free from defects. Apply a small amount of lubricant (included with the seal) to all o-rings.

Installation

Push the seal evenly onto the shaft using hand pressure only as shown in Figure 20.



Figure 20 — Seal installation on Shaft

If the seal is equipped with a drain port, rotate it to the 6 o'clock position. Guardian, Iso-Gard, and Micro-Tec II isolators are provided with an orientation slot on the outside diameter of the stator. This slot should be rotated to the 12 o'clock position to ensure

appropriate orientation of the drain port. Equalizer seals can be installed in any direction, so there is no need to position the seal. See Figure 21 for clarification.

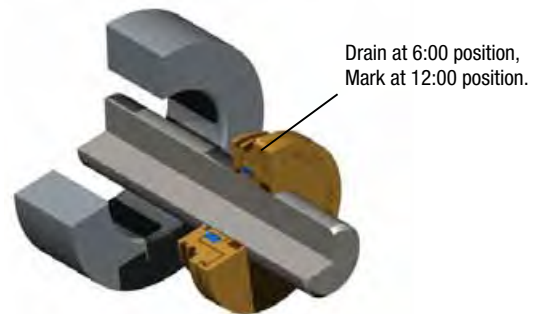

Figure 21 — Drain Port Positioning

Push the seal gently into the bore using hand pressure only. If necessary, gently tap the seal using a soft faced tool. Flanged seals are fully seated when the flange is flush against the housing. Flangeless seal can be installed at the bottom of the housing, or flush with the bore face. See Figure 22.

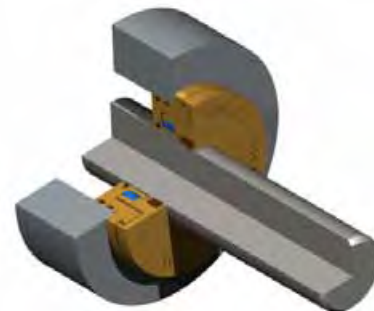

Figure 22 — Flanged Seal Flush with Housing Face

Post Installation

Inspection

Once the seal has been installed, carefully inspect the sealing area, looking for damage to the seal. Confirm that the rotor rotates by gently spinning the shaft.

Never flood the bearing isolator or block the expulsion ports. These conditions will cause seal failure.

Removal

Removal of old isolators should be performed similar to the installation, but from the back side of the seal. If access to the backside is not possible, gently pry the seal from the housing bore in small increments, working around the seal in a star pattern. Care must be taken not to damage the shaft or housing bore.

Table 14 — Seal Selection Guide*

Seal Type	Shaft Size				Type of Motion		Speed (FPM)					Max Radial Misalignment (inches)					Max Pressure			Media Level			Seal Material**											
	0-3 Inches	3-6 Inches	6-12 Inches	Over 12 Inches	Rotary	Reciprocating	0-1000	1000-2000	2000-3000	3000-5000	5000-7000	7000-12000	0.010	0.015	0.020	0.093	0.100	0.125	Ambient	7 psi	150 psi	Below Shaft	Half Shaft	Fully Submerged	MIL-Right® N	MIL-Right® ES	MIL-Right® V	Silicone	GYLON®	Bronze	Stainless Steel	PTFE		
Model 57	X	X	X		X	X	X					X						X	X		X	X	X	X	X	X								
Model 58	X	X	X		X	X	X					X						X	X		X													
Model 63	X				X		X	X				X	X					X	X		X	X	X	X	X	X	X							
Model 53		X	X	X	X		X	X	X			X	X					X	X		X	X	X	X	X	X	X							
Model 23		X	X	X	X		X	X				X						X			X	X			X	X	X	X						
Model 26 (solid)	X	X	X	X	X	X	X	X	X			X	X					X	X		X	X	X	X	X	X	X							
Model 26 (split)	X	X	X	X	X		X	X	X	X		X	X					X			X	X			X	X	X							
Model 59			X	X	X	X	X	X	X	X		X	X	X	X			X	X		X	X	X	X	X	X	X							
Model 87			X	X	X	X	X	X	X	X		X	X	X	X	X		X	X		X	X	X	X	X	X	X							
Model 64			X	X	X		X	X	X	X	X	X	X	X	X	X	X	X	X		X	X	X	X	X	X	X	X						
Model 145†			X	X	X		X	X	X	X		N/A	N/A	N/A	N/A	N/A	N/A	X			N/A	N/A	N/A											
Model 144			X	X			X	X	X			N/A	N/A	N/A	N/A	N/A	N/A	X			N/A	N/A	N/A	X										
Model 143†			X	X	X		X	X	X	X		N/A	N/A	N/A	N/A	N/A	N/A	X			N/A	N/A	N/A											
P/S®-I (Model 61)	X	X	X		X	X	X	X				Under 0.005						X	X	X	X	X	X											
GUARDIAN™†	X	X	X	X	X		X	X	X	X	X	X	X	X				X			X												X	X
Split GUARDIAN™†	X	X	X	X	X		X	X	X	X		X	X	X				X			X												X	X
MICRO-TEC®†	X	X	X	X	X		X	X	X	X		X	X	X				X			X												X	X
ISO-GARD®†	X	X	X	X	X		X	X	X	X		X	X	X				X			X													X
EQUALIZER®†	X	X	X	X	X		X	X	X	X		X	X					X			X													X

*The values shown are generally applicable limits. Please consult Klozure® Engineering for specific application assistance.

**Seal Materials shown are typical. Other materials may be available upon request. For more information please contact Klozure® Engineering.

#Model 145 and 143 Face Seals are not available in Mill-Right® materials but are supplied in standard NBR, HNBR & FKM Materials.

†Guardian™, Micro-Tec® II, Iso-Gard®, and Equalizer® Bearing Isolators are supplied with fluoroelastomer O-rings.

For alternate O-ring materials please contact Klozure® Engineering.

Table 15 — Material Selection Guide*

Material Type#	Color	Durometer	Coefficient of Friction	Operating Temperature	Max Spike Temperature	Abrasion Resistance	Chemical Resistance	Comparative Cost
MIL-Right® N	Black	80	1.788	-40°F to 200°F (-40°C to 93°C)	250°F (123°C)	Moderate	Moderate	Low
MIL-Right® ES	Dark Blue	88	1.053	-40°F to 300°F (-40°C to 150°C)	350°F (177°C)	High	Improved	Moderate
MIL-Right® V	Green	76	1.158	-22°F to 400°F (-30°C to 204°C)	450°F (232°C)	High	Very Good	High
Silicone	Light Blue (FDA - Red)	82	Over 2.000	-75°F to 350°F (-59°C to 177°C)	400°F (204°C)	Low	Excellent	High
GYLON®	Black (FDA - White)	N/A	0.100	-120°F to 400°F (-84°C to 204°C)	450°F (232°C)	High	Excellent	High

*The values shown are generally applicable limits. Please consult Klozure® Engineering for specific application assistance.

#Seal Materials shown are typical style materials for oil seals. Other materials may be available upon request. For more information please contact Klozure® Engineering.

SHELF LIFE FOR KLOZURE® OIL SEALS AND BEARING ISOLATORS

Radial lip type seals and bearing isolators should be stored with caution. The service life of bearings and other costly machined parts may depend upon how well the sealing component is stored. Hazards which may be encountered include: temperature, ozone, humidity, radioactive materials, fumes, insects, rodents, dust, grit and mechanical damage. The storage area should be cool (60 - 90°F) and with average (40 - 70%) humidity. Seals should be stored on a first-in/first-out basis, since even under ideal conditions, an unusually long shelf life may cause deterioration of component materials.

MATERIAL SHELF LIFE

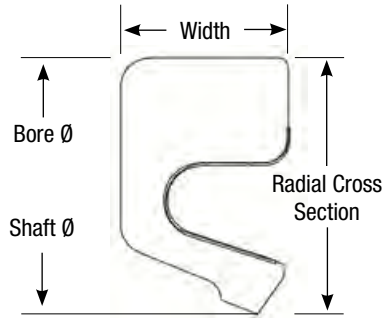

Material	Shelf Life
MILL-RIGHT® N / NBR	5 YEARS
MILL-RIGHT® ES / HNBR	7 YEARS
MILL-RIGHT® V / FKM	10 YEARS
SILICONE / VMQ	10 YEARS
GYLON® and PTFE	INDEFINITE

Reference Dimensions







Model 3 	Model 21 	Model 23 	Model 24 	Model 25 	Model 26 	Model 26E 	Model 26R1
Model 53 	Model 53F1 	Model 53G1 	Model 53R1 	Model 53R2 	Model 53T2 	Model 53TB 	Model 53TF
Model 54 	Model 57 	Model 58 	Model 59 	Model 59G1 	PS°-I 	PS°-I Dbl Opposed 	PS°-I Dbl Tandem
PS°-I Reverse Lip 	Model 62 	Model 63 	Model 63F1 	Model 63G1 	Model 63R1 	Model 63R2 	Model 63T2
Model 63TB 	Model 63TF 	Model 64 	Model 64G1 	Model 71 	Model 76 	Model 87 	Model 88
Model 91 	Model 92 	Model 94 	Model 111 	Model 113 	Model 123 	Model 143 	Model 144
Model 145 	Model 151 	Model 154 	Model 154R1 	Model 154M 			



Large Seals	Features	Materials	Temp	Shaft Diameter in. (mm)	Surface Speed	Spring Type	Misalign. in. @ f/m (mm@m/s)	Pressure
 <p>Model 26</p>	<ul style="list-style-type: none"> High-performance seal Solid or split design Reverse bevel lip design prevents lip rollover Reinforced rubber O.D. Single and dual lip configurations available 	<ul style="list-style-type: none"> MILL-RIGHT® N MILL-RIGHT® ES MILL-RIGHT® V 	<ul style="list-style-type: none"> -40°F (-40°C) to 200°F (93°C) -40°F (-40°C) to 300°F (150°C) -22°F (-30°C) to 400°F (204°C) 	0.750 to 60.000 (19.0 to 1524.0)	5,000 f/m (25.4 m/s)	Molded-in stainless steel finger	<ul style="list-style-type: none"> 0.015 @ 1,000 (0.38 @ 5.1) 0.010 @ 2,000 (0.25 @ 10.2) 0.008 @ 5,000 (0.20 @ 25.4) 	To 7 psi (0.4 bar) (N/A if split)
 <p>Model 26R1</p>	<ul style="list-style-type: none"> High-performance dual lip seal Reverse bevel lip design prevents lip rollover Dust lip prevents ingress of light contaminants 	<ul style="list-style-type: none"> MILL-RIGHT® N MILL-RIGHT® ES MILL-RIGHT® V 	<ul style="list-style-type: none"> -40°F (-40°C) to 200°F (93°C) -40°F (-40°C) to 300°F (150°C) -22°F (-30°C) to 400°F (204°C) 	0.750 to 60.000 (19.05 to 1524.0)	5,000 f/m (25.4 m/s)	Molded-in stainless steel finger	<ul style="list-style-type: none"> 0.015 @ 1,000 (0.38 @ 5.1) 0.010 @ 2,000 (0.25 @ 10.2) 0.008 @ 5,000 (0.20 @ 25.4) 	To 7 psi (0.4 bar) (N/A if split)
 <p>Model 59</p>	<ul style="list-style-type: none"> Severe service assembled seal Heavy duty outer case Reverse bevel lip design prevents lip rollover Aggressive shaft-to-bore misalignment capability 	<ul style="list-style-type: none"> MILL-RIGHT® N MILL-RIGHT® ES MILL-RIGHT® V 	<ul style="list-style-type: none"> -40°F (-40°C) to 200°F (93°C) -40°F (-40°C) to 300°F (150°C) -22°F (-30°C) to 400°F (204°C) 	6.000 to 70.000 (152.4 to 1778.0)	5,000 f/m (25.4 m/s)	Molded-in stainless steel finger	<ul style="list-style-type: none"> 0.093 @ 2,500 (2.36 @ 12.7) 0.047 @ 5,000 (1.19 @ 25.4) 	To 7 psi (0.4 bar)
 <p>Model 59G1</p>	<ul style="list-style-type: none"> Severe service dual lip assembled seal GYLON® excluder lip for non-lubricated external conditions or corrosive external conditions 	<ul style="list-style-type: none"> MILL-RIGHT® N MILL-RIGHT® ES MILL-RIGHT® V 	<ul style="list-style-type: none"> -40°F (-40°C) to 200°F (93°C) -40°F (-40°C) to 300°F (150°C) -22°F (-30°C) to 400°F (204°C) 	6.000 to 40.000 (152.4 to 1016.0)	2,500 f/m (12.7 m/s)	Molded-in stainless steel finger	<ul style="list-style-type: none"> 0.010 @ 2,500 (0.25 @ 12.7) 	To 7 psi (0.4 bar)
 <p>Model 64®</p>	<ul style="list-style-type: none"> Severe service assembled seal Heavy duty metal outer case Unique carrier/garter spring combination Industry's highest shaft-to-bore misalignment capability 	<ul style="list-style-type: none"> MILL-RIGHT® N MILL-RIGHT® ES MILL-RIGHT® V 	<ul style="list-style-type: none"> -40°F (-40°C) to 200°F (93°C) -40°F (-40°C) to 300°F (150°C) -22°F (-30°C) to 400°F (204°C) 	8.000 to 74.409 (203.2 to 1890.0)	7,000 f/m (35.6 m/s)	Combination of stainless steel garter & stainless steel finger	<ul style="list-style-type: none"> 0.125 @ 5,000 (3.18 @ 25.4) 0.093 @ 7,000 (2.36 @ 35.6) 	To 7 psi (0.4 bar)
 <p>Model 64G1</p>	<ul style="list-style-type: none"> Severe service dual lip assembled seal GYLON® excluder lip for non-lubricated external conditions or corrosive external conditions 	<ul style="list-style-type: none"> MILL-RIGHT® N MILL-RIGHT® ES MILL-RIGHT® V 	<ul style="list-style-type: none"> -40°F (-40°C) to 200°F (93°C) -40°F (-40°C) to 300°F (150°C) -22°F (-30°C) to 400°F (204°C) 	8.000 to 55.000 (203.20 to 1397.0)	3,500 f/m (17.9 m/s)	Combination of stainless steel garter & stainless steel finger	<ul style="list-style-type: none"> 0.010 @ 3,500 (0.25 @ 17.9) 	To 7 psi (0.4 bar)
 <p>Model 87</p>	<ul style="list-style-type: none"> Severe service seal Metal reinforced rubber O.D. Reverse bevel lip design prevents lip rollover Aggressive shaft-to-bore misalignment capability 	<ul style="list-style-type: none"> MILL-RIGHT® N MILL-RIGHT® ES MILL-RIGHT® V 	<ul style="list-style-type: none"> -40°F (-40°C) to 200°F (93°C) -40°F (-40°C) to 300°F (150°C) -22°F (-30°C) to 400°F (204°C) 	6.000 to 48.000 (152.4 to 1219.2)	5,000 f/m (25.4 m/s)	Molded-in carbon steel garter	<ul style="list-style-type: none"> 0.100 @ 2,500 (2.54 @ 12.7) 0.050 @ 5,000 (1.27 @ 25.4) 	To 7 psi (0.4 bar)
 <p>Model 88</p>	<ul style="list-style-type: none"> Severe service seal Aggressive shaft-to-bore misalignment capability Metal reinforced rubber OD for positive bore retention 	<ul style="list-style-type: none"> MILL-RIGHT® N MILL-RIGHT® ES MILL-RIGHT® V 	<ul style="list-style-type: none"> -40°F (-40°C) to 200°F (93°C) -40°F (-40°C) to 300°F (150°C) -22°F (-30°C) to 400°F (204°C) 	6.000 to 48.000 (152.4 to 1219.2)	5,000 f/m (25.4 m/s)	Molded-in carbon steel garter	<ul style="list-style-type: none"> 0.050 @ 2,500 (1.27 @ 12.7) 0.025 @ 5000 (0.64 @ 25.4) 	To 7 psi (0.4 bar)
 <p>Model 151</p>	<ul style="list-style-type: none"> General service seal Solid or split design Reinforced rubber OD Coverplate required 	<ul style="list-style-type: none"> Nitrile Hydrogenated Nitrile Fluoroelastomer 	<ul style="list-style-type: none"> -40°F (-40°C) to 200°F (93°C) -40°F (-40°C) to 300°F (150°C) -22°F (-30°C) to 400°F (204°C) 	1.000 & up (25.4 & up)	2,000 f/m (10.2 m/s)	<ul style="list-style-type: none"> Carbon steel garter spring (NBR & HNBR) Stainless steel garter spring (FKM) 	<ul style="list-style-type: none"> 0.010 @ 2,000 (0.25 @ 10.2) 	To 7 psi (0.4 bar) (N/A if split)

Large Seals	Features	Materials	Temp	Shaft Diameter in. (mm)	Surface Speed	Spring Type	Misalign. in. @ f/m (mm@m/s)	Pressure
 <p>Model 154</p>	<ul style="list-style-type: none"> General service seal Solid or split design Reinforced rubber OD Reverse bevel lip design prevents lip roll over Coverplate required 	<ul style="list-style-type: none"> Nitrile Hydrogenated Nitrile Fluoroelastomer 	-40°F (-40°C) to 200°F (93°C) -40°F (-40°C) to 300°F (150°C) -22°F (-30°C) to 400°F (204°C)	1.000 & up (25.4 & up)	3,000 f/m (15.2 m/s)	Carbon steel garter spring (NBR & HNBR) Stainless steel garter spring (FKM)	0.010 @ 3,000 (0.25 @ 15.2)	To 7 psi (0.4 bar) (N/A if split)
 <p>Model 154R1</p>	<ul style="list-style-type: none"> General service dual lip seal Solid or split design Reinforced rubber OD Reverse bevel lip design prevents lip roll over Dust lip prevents ingress of light contaminants Coverplate required 	<ul style="list-style-type: none"> Nitrile Hydrogenated Nitrile Fluoroelastomer 	-40°F (-40°C) to 200°F (93°C) -40°F (-40°C) to 300°F (150°C) -22°F (-30°C) to 400°F (204°C)	3.000 & up (76.2 & up)	3,000 f/m (15.2 m/s)	Carbon steel garter spring (NBR & HNBR) Stainless steel garter spring (FKM)	0.010 @ 3,000 (0.25 @ 15.2)	To 7 psi (0.4 bar) (N/A if split)
 <p>Model 154M</p>	<ul style="list-style-type: none"> General service seal Metal-reinforced rubber OD eliminates need for cover plate Excels in environments where corrosion is typically a problem Reverse bevel lip design prevents lip roll over 	<ul style="list-style-type: none"> Nitrile Hydrogenated Nitrile Fluoroelastomer 	-40°F (-40°C) to 200°F (93°C) -40°F (-40°C) to 300°F (150°C) -22°F (-30°C) to 400°F (204°C)	3.000 & up (76.2 & up)	3,000 f/m (15.2 m/s)	Carbon steel garter spring (NBR & HNBR) Stainless steel garter spring (FKM)	0.020 @ 1,000 (0.51 @ 5.1) 0.010 @ 2,000 (0.25 @ 10.2) 0.005 @ 3,000 (0.13 @ 15.2)	To 7 psi (0.4 bar)







Most designs available without spring.
 Most designs available in silicone and other materials.

Small Seals	Features	Materials	Temp	Shaft Diameter in. (mm)	Surface Speed	Spring Type	Misalign. in. @ f/m (mm@m/s)	Pressure
 <p>Model 53</p>	<ul style="list-style-type: none"> General purpose assembled seal Heavy-duty metal outer case Single and dual lip configurations available 	<ul style="list-style-type: none"> MILL-RIGHT® N MILL-RIGHT® ES MILL-RIGHT® V 	-40°F (-40°C) to 200°F (93°C) -40°F (-40°C) to 300°F (150°C) -22°F (-30°C) to 400°F (204°C)	3.000 to 60.000 (76.2 to 1524.0)	3,000 f/m (15.2 m/s)	Stainless steel finger	0.015 @ 1,000 (0.38 @ 5.1) 0.010 @ 2,000 (0.25 @ 10.2) 0.005 @ 3,000 (0.13 @ 15.2)	To 7 psi (0.4 bar)
 <p>Model 53G1</p>	<ul style="list-style-type: none"> General purpose dual lip seal GYLON® excluder lip for non-lubricated external conditions or corrosive external conditions 	<ul style="list-style-type: none"> MILL-RIGHT® N MILL-RIGHT® ES MILL-RIGHT® V 	-40°F (-40°C) to 200°F (93°C) -40°F (-40°C) to 300°F (150°C) -22°F (-30°C) to 400°F (204°C)	3.000 to 40.000 (76.2 to 1016.0)	1,500 f/m (7.6 m/s)	Stainless steel finger	0.010 @ 1,500 (0.25 @ 7.6)	To 7 psi (0.4 bar)
 <p>Model 53R1</p>	<ul style="list-style-type: none"> General purpose dual lip seal Dual lips oppose for exclusion and retention Spring in one element only 	<ul style="list-style-type: none"> MILL-RIGHT® N MILL-RIGHT® ES MILL-RIGHT® V 	-40°F (-40°C) to 200°F (93°C) -40°F (-40°C) to 300°F (150°C) -22°F (-30°C) to 400°F (204°C)	3.000 to 15.000 (76.2 to 381.0)	2,000 f/m (10.2 m/s)	Stainless steel finger	0.015 @ 1,000 (0.38 @ 5.1) 0.010 @ 2,000 (0.25 @ 10.2)	To 7 psi (0.4 bar)
 <p>Model 53R2</p>	<ul style="list-style-type: none"> General purpose dual lip seal Dual lips oppose for exclusion and retention Spring in both elements 	<ul style="list-style-type: none"> MILL-RIGHT® N MILL-RIGHT® ES MILL-RIGHT® V 	-40°F (-40°C) to 200°F (93°C) -40°F (-40°C) to 300°F (150°C) -22°F (-30°C) to 400°F (204°C)	3.000 to 15.000 (76.2 to 381.0)	1,000 f/m (5.1 m/s)	Stainless steel finger	0.010 @ 500 (0.25 @ 2.5) 0.005 @ 1,000 (0.13 @ 5.1)	To 7 psi (0.4 bar)
 <p>Model 53TB</p>	<ul style="list-style-type: none"> General purpose dual lip seal Lips set in tandem configuration Spring in back element 	<ul style="list-style-type: none"> MILL-RIGHT® N MILL-RIGHT® ES MILL-RIGHT® V 	-40°F (-40°C) to 200°F (93°C) -40°F (-40°C) to 300°F (150°C) -22°F (-30°C) to 400°F (204°C)	3.000 to 15.000 (76.2 to 381.0)	1,000 f/m (5.1 m/s)	Stainless steel finger	0.010 @ 500 (0.25 @ 2.5) 0.005 @ 1,000 (0.13 @ 5.1)	To 7 psi (0.4 bar)



Small Seals	Features	Materials	Temp	Shaft Diameter in. (mm)	Surface Speed	Spring Type	Misalign. in. @ f/m (mm@m/s)	Pressure
 <p>Model 53TF</p> <ul style="list-style-type: none"> General purpose dual lip seal Lips set in tandem configuration Spring in one element 	<ul style="list-style-type: none"> MILL-RIGHT® N MILL-RIGHT® ES MILL-RIGHT® V 	<p>-40°F (-40°C) to 200°F (93°C)</p> <p>-40°F (-40°C) to 300°F (150°C)</p> <p>-22°F (-30°C) to 400°F (204°C)</p>	3.000 to 15.000 (76.2 to 381.0)	1,000 f/m (5.1 m/s)	Stainless steel finger	0.010 @ 500 (0.25 @ 2.5) 0.005 @ 1,000 (0.13 @ 5.1)	To 7 psi (0.4 bar)	
 <p>Model 53T2</p> <ul style="list-style-type: none"> General purpose dual lip seal Lips set in tandem configuration Spring in both elements 	<ul style="list-style-type: none"> MILL-RIGHT® N MILL-RIGHT® ES MILL-RIGHT® V 	<p>-40°F (-40°C) to 200°F (93°C)</p> <p>-40°F (-40°C) to 300°F (150°C)</p> <p>-22°F (-30°C) to 400°F (204°C)</p>	3.000 to 15.000 (76.2 to 381.0)	1,000 f/m (5.1 m/s)	Stainless steel finger	0.010 @ 500 (0.25 @ 2.5) 0.005 @ 1,000 (0.13 @ 5.1)	To 7 psi (0.4 bar)	
 <p>Model 53F1</p> <ul style="list-style-type: none"> General purpose dual lip seal Heavy-duty metal outer case Felt excuder 	<ul style="list-style-type: none"> MILL-RIGHT® N MILL-RIGHT® ES MILL-RIGHT® V 	<p>-40°F (-40°C) to 200°F (93°C)</p> <p>-40°F (-40°C) to 300°F (150°C)</p> <p>-22°F (-30°C) to 400°F (204°C)</p>	3.000 to 15.000 (76.2 to 381.0)	1,000 f/m (5.1 m/s)	Stainless steel finger	0.010 @ 1,000 (0.25 @ 5.1)	To 7 psi (0.4 bar)	
 <p>Model 63</p> <ul style="list-style-type: none"> General purpose assembled seal Heavy-duty metal outer case Single and dual lip configurations available 	<ul style="list-style-type: none"> MILL-RIGHT® N MILL-RIGHT® ES MILL-RIGHT® V 	<p>-40°F (-40°C) to 200°F (93°C)</p> <p>-40°F (-40°C) to 300°F (150°C)</p> <p>-22°F (-30°C) to 400°F (204°C)</p>	0.250 to 3.000 (6.4 to 76.2)	3,000 f/m (15.2 m/s)	Stainless steel finger	0.015 @ 1,000 (0.38 @ 5.1) 0.010 @ 2,000 (0.25 @ 10.2) 0.005 @ 3,000 (0.13 @ 15.2)	To 7 psi (0.4 bar)	
 <p>Model 63G1</p> <ul style="list-style-type: none"> General purpose dual lip seal GYLON® excuder lip for non-lubricated external conditions or corrosive external conditions 	<ul style="list-style-type: none"> MILL-RIGHT® N MILL-RIGHT® ES MILL-RIGHT® V 	<p>-40°F (-40°C) to 200°F (93°C)</p> <p>-40°F (-40°C) to 300°F (150°C)</p> <p>-22°F (-30°C) to 400°F (204°C)</p>	0.250 to 3.000 (6.4 to 76.2)	1,500 f/m (7.6 m/s)	Stainless steel finger	(0.010 @ 1,500) (0.25 @ 7.6)	To 7 psi (0.4 bar)	
 <p>Model 63R1</p> <ul style="list-style-type: none"> General purpose dual lip seal Dual lips oppose for exclusion and retention Spring in one element only 	<ul style="list-style-type: none"> MILL-RIGHT® N MILL-RIGHT® ES MILL-RIGHT® V 	<p>-40°F (-40°C) to 200°F (93°C)</p> <p>-40°F (-40°C) to 300°F (150°C)</p> <p>-22°F (-30°C) to 400°F (204°C)</p>	0.250 to 3.000 (6.4 to 76.2)	2,000 f/m (10.2 m/s)	Stainless steel finger	0.015 @ 1,000 (0.38 @ 5.1) 0.010 @ 2,000 (0.25 @ 10.2)	To 7 psi (0.4 bar)	
 <p>Model 63R2</p> <ul style="list-style-type: none"> General purpose dual lip seal Dual lips oppose for exclusion and retention Spring in both elements 	<ul style="list-style-type: none"> MILL-RIGHT® N MILL-RIGHT® ES MILL-RIGHT® V 	<p>-40°F (-40°C) to 200°F (93°C)</p> <p>-40°F (-40°C) to 300°F (150°C)</p> <p>-22°F (-30°C) to 400°F (204°C)</p>	0.250 to 3.000 (6.4 to 76.2)	1,000 f/m (5.1 m/s)	Stainless steel finger	0.010 @ 500 (0.25 @ 2.5) 0.005 @ 1,000 (0.13 @ 5.1)	To 7 psi (0.4 bar)	
 <p>Model 63TB</p> <ul style="list-style-type: none"> General purpose dual lip seal Non-sprung front lip serves as a baffle Lips set in tandem configuration 	<ul style="list-style-type: none"> MILL-RIGHT® N MILL-RIGHT® ES MILL-RIGHT® V 	<p>-40°F (-40°C) to 200°F (93°C)</p> <p>-40°F (-40°C) to 300°F (150°C)</p> <p>-22°F (-30°C) to 400°F (204°C)</p>	0.250 to 3.000 (6.4 to 76.2)	1,000 f/m (5.1 m/s)	Stainless steel finger	0.010 @ 500 (0.25 @ 2.5) 0.005 @ 1,000 (0.13 @ 5.1)	To 7 psi (0.4 bar)	
 <p>Model 63TF</p> <ul style="list-style-type: none"> General purpose dual lip seal Non-sprung back lip serves as a baffle Lips set in tandem configuration 	<ul style="list-style-type: none"> MILL-RIGHT® N MILL-RIGHT® ES MILL-RIGHT® V 	<p>-40°F (-40°C) to 200°F (93°C)</p> <p>-40°F (-40°C) to 300°F (150°C)</p> <p>-22°F (-30°C) to 400°F (204°C)</p>	0.250 to 3.000 (6.4 to 76.2)	1,000 f/m (5.1 m/s)	Stainless steel finger	0.010 @ 500 (0.25 @ 2.5) 0.005 @ 1,000 (0.13 @ 5.1)	To 7 psi (0.4 bar)	







Small Seals	Features	Materials	Temp	Shaft Diameter in. (mm)	Surface Speed	Spring Type	Misalign. in. @ f/m (mm@m/s)	Pressure
 <p>Model 63T2</p> <ul style="list-style-type: none"> General purpose dual lip seal Lips set in tandem configuration Spring in both elements 	<ul style="list-style-type: none"> MILL-RIGHT® N MILL-RIGHT® ES MILL-RIGHT® V 	-40°F (-40°C) to 200°F (93°C) -40°F (-40°C) to 300°F (150°C) -22°F (-30°C) to 400°F (204°C)	0.250 to 3.000 (6.4 to 76.2)	1,000 f/m (5.1 m/s)	Stainless steel finger	0.010 @ 500 (0.25 @ 2.5) 0.005 @ 1,000 (0.13 @ 5.1)	To 7 psi (0.4 bar)	
 <p>Model 63F1</p> <ul style="list-style-type: none"> General purpose dual lip seal Felt excuder 	<ul style="list-style-type: none"> MILL-RIGHT® N MILL-RIGHT® ES MILL-RIGHT® V 	-40°F (-40°C) to 200°F (93°C) -40°F (-40°C) to 300°F (150°C) -22°F (-30°C) to 400°F (204°C)	0.250 to 3.000 (6.4 to 76.2)	1,000 f/m (5.1 m/s)	Stainless steel finger	0.010 @ 1,000 (0.25 @ 5.1)	To 7 psi (0.4 bar)	



Most designs available without spring.
 Most designs available in silicone and other materials.

Small Seals Bonded Seals	Features	Materials	Temp	Shaft Diameter in. (mm)	Surface Speed	Spring Type	Misalign. in. @ f/m (mm@m/s)	Pressure
 <p>Model 3</p> <ul style="list-style-type: none"> General purpose bonded seal Metal outer case Dual lip design 	<ul style="list-style-type: none"> Nitrile Fluoroelastomer 	-40°F (-40°C) to 200°F (93°C) -22°F (-30°C) to 400°F (204°C)	0.250 to 8.000 (6.3 to 203.2)	3,000 f/m (15.2 m/s)	Carbon steel garter	0.015 @ 1,000 (0.38 @ 5.1) 0.010 @ 2,000 (0.25 @ 10.2) 0.005 @ 3,000 (0.13 @ 15.2)	To 7 psi (0.4 bar)	
 <p>Model 71</p> <ul style="list-style-type: none"> General purpose bonded seal No spring Ideal for grease retention or contamination exclusion 	<ul style="list-style-type: none"> Nitrile Fluoroelastomer 	-40°F (-40°C) to 200°F (93°C) -22°F (-30°C) to 400°F (204°C)	0.250 to 7.250 (6.3 to 184.1)	1,000 f/m (5.1 m/s)	N/A	0.005 @ 1000 (0.13 @ 5.1)	To 7 psi (0.4 bar)	
 <p>Model 76</p> <ul style="list-style-type: none"> General purpose bonded seal Metal outer case 	<ul style="list-style-type: none"> Nitrile Fluoroelastomer 	-40°F (-40°C) to 200°F (93°C) -22°F (-30°C) to 400°F (204°C)	0.250 to 8.000 (6.3 to 203.2)	3,000 f/m (15.2 m/s)	Carbon steel garter	0.015 @ 1,000 (0.38 @ 5.1) 0.010 @ 2,000 (0.25 @ 10.2) 0.005 @ 3,000 (0.13 @ 15.2)	To 7 psi (0.4 bar)	
 <p>Model 91</p> <ul style="list-style-type: none"> General purpose bonded seal No spring Ideal for grease retention or contamination exclusion 	<ul style="list-style-type: none"> Nitrile Fluoroelastomer 	-40°F (-40°C) to 200°F (93°C) -22°F (-30°C) to 400°F (204°C)	0.281 to 5.000 (7.1 to 127.0)	1,000 f/m (5.1 m/s)	N/A	0.005 @ 1,000 (0.13 @ 5.1)	To 7 psi (0.4 bar)	
 <p>Model 92</p> <ul style="list-style-type: none"> General purpose bonded seal Metal reinforced rubber OD 	<ul style="list-style-type: none"> Nitrile Fluoroelastomer 	-40°F (-40°C) to 200°F (93°C) -22°F (-30°C) to 400°F (204°C)	0.250 to 12.500 (6.4 to 317.5)	3,000 f/m (15.2 m/s)	Carbon steel garter	0.015 @ 1,000 (0.38 @ 5.1) 0.010 @ 2,000 (0.25 @ 10.2) 0.005 @ 3,000 (0.13 @ 15.2)	To 7 psi (0.4 bar)	
 <p>Model 94</p> <ul style="list-style-type: none"> General purpose bonded seal Metal reinforced rubber OD Dual lip design 	<ul style="list-style-type: none"> Nitrile Fluoroelastomer 	-40°F (-40°C) to 200°F (93°C) -22°F (-30°C) to 400°F (204°C)	0.438 to 7.375 (11.1 to 187.3)	3,000 f/m (15.2 m/s)	Carbon steel garter	0.015 @ 1,000 (0.38 @ 5.1) 0.010 @ 2,000 (0.25 @ 10.2) 0.005 @ 3,000 (0.13 @ 15.2)	To 7 psi (0.4 bar)	

Small Seals Bonded Seals	Features	Materials	Temp	Shaft Diameter in. (mm)	Surface Speed	Spring Type	Misalign. in. @ f/m (mm@m/s)	Pressure
Model TA,TB,TM	<ul style="list-style-type: none"> Bonded seal Metal outer case Dual lip design 	<ul style="list-style-type: none"> Nitrile Fluoroelastomer 	-40°F (-40°C) to 200°F (93°C) -22°F (-30°C) to 400°F (204°C)	0.250 to 8.000 (6.3 to 203.2)	3,000 f/m (15.2 m/s)	Carbon steel garter	0.015 @ 1,000 (0.38 @ 5.1) 0.010 @ 2,000 (0.25 @ 10.2) 0.005 @ 3,000 (0.13 @ 15.2)	To 7 psi (0.4 bar)
Model VA,VB,VM	<ul style="list-style-type: none"> Bonded seal Metal outer case No spring 	<ul style="list-style-type: none"> Nitrile Fluoroelastomer 	-40°F (-40°C) to 200°F (93°C) -22°F (-30°C) to 400°F (204°C)	0.250 to 7.250 (6.3 to 184.1)	1,000 f/m (5.1 m/s)	N/A	0.005 @ 1000 (0.13 @ 5.1)	To 7 psi (0.4 bar)
Model SB,SM	<ul style="list-style-type: none"> Bonded seal Metal outer case Single spring loaded lip 	<ul style="list-style-type: none"> Nitrile Fluoroelastomer 	-40°F (-40°C) to 200°F (93°C) -22°F (-30°C) to 400°F (204°C)	0.250 to 8.000 (6.3 to 203.2)	3,000 f/m (15.2 m/s)	Carbon steel garter	0.015 @ 1,000 (0.38 @ 5.1) 0.010 @ 2,000 (0.25 @ 10.2) 0.005 @ 3,000 (0.13 @ 15.2)	To 7 psi (0.4 bar)
Model VC	<ul style="list-style-type: none"> Bonded seal Metal reinforced rubber OD No spring 	<ul style="list-style-type: none"> Nitrile Fluoroelastomer 	-40°F (-40°C) to 200°F (93°C) -22°F (-30°C) to 400°F (204°C)	0.281 to 5.000 (7.1 to 127.0)	1,000 f/m (5.1 m/s)	N/A	0.005 @ 1,000 (0.13 @ 5.1)	To 7 psi (0.4 bar)
Model SC,SF	<ul style="list-style-type: none"> Bonded seal Metal outer case Single spring loaded lip 	<ul style="list-style-type: none"> Nitrile Fluoroelastomer 	-40°F (-40°C) to 200°F (93°C) -22°F (-30°C) to 400°F (204°C)	0.250 to 12.500 (6.4 to 317.5)	3,000 f/m (15.2 m/s)	Carbon steel garter	0.015 @ 1,000 (0.38 @ 5.1) 0.010 @ 2,000 (0.25 @ 10.2) 0.005 @ 3,000 (0.13 @ 15.2)	To 7 psi (0.4 bar)
Model TC	<ul style="list-style-type: none"> Bonded seal Metal reinforced rubber OD Dual lip design 	<ul style="list-style-type: none"> Nitrile Fluoroelastomer 	-40°F (-40°C) to 200°F (93°C) -22°F (-30°C) to 400°F (204°C)	0.438 to 7.375 (11.1 to 187.3)	3,000 f/m (15.2 m/s)	Carbon steel garter	0.015 @ 1,000 (0.38 @ 5.1) 0.010 @ 2,000 (0.25 @ 10.2) 0.005 @ 3,000 (0.13 @ 15.2)	To 7 psi (0.4 bar)

Split Seals	Features	Materials	Temp	Shaft Diameter in. (mm)	Surface Speed	Spring Type	Misalign. in. @ f/m (mm@m/s)	Pressure
 Model 21	<ul style="list-style-type: none"> General purpose split seal Low-speed service Cover plate required 	<ul style="list-style-type: none"> MILL-RIGHT® N MILL-RIGHT® ES MILL-RIGHT® V 	-40°F (-40°C) to 200°F (93°C) -40°F (-40°C) to 300°F (150°C) -22°F (-30°C) to 400°F (204°C)	3.000 to 42.000 (76.2 to 1066.8)	1,000 f/m (5.1 m/s)	Molded-in stainless steel finger	0.010 @ 500 (0.25 @ 2.5) 0.005 @ 1,000 (0.13 @ 5.1)	N/A
 Model 23	<ul style="list-style-type: none"> General service split seal Cover plate required Over 300,000 sizes readily available 	<ul style="list-style-type: none"> MILL-RIGHT® N MILL-RIGHT® ES MILL-RIGHT® V 	-40°F (-40°C) to 200°F (93°C) -40°F (-40°C) to 300°F (150°C) -22°F (-30°C) to 400°F (204°C)	3.000 (76.2) and up	2,000 f/m (10.2 m/s)	Molded-in stainless steel finger	0.010 @ 1,000 (0.25 @ 5.1) 0.005 @ 2,000 (0.13 @ 10.2)	N/A
 Model 24	<ul style="list-style-type: none"> Special purpose split seal for tapered housing grooves Low-speed service Tapered O.D. Cover plate required 	<ul style="list-style-type: none"> MILL-RIGHT® N MILL-RIGHT® ES MILL-RIGHT® V 	-40°F (-40°C) to 200°F (93°C) -40°F (-40°C) to 300°F (150°C) -22°F (-30°C) to 400°F (204°C)	3.000 to 21.500 (76.2 to 546.1)	1,000 f/m (5.1 m/s)	Molded-in stainless steel finger	0.010 @ 500 (0.25 @ 2.5) 0.005 @ 1,000 (0.13 @ 5.1)	N/A



Split Seals	Features	Materials	Temp	Shaft Diameter in. (mm)	Surface Speed	Spring Type	Misalign. in. @ f/m (mm@m/s)	Pressure
 <p>Model 25</p>	<ul style="list-style-type: none"> • PTFE split seal • Low-speed service • Excellent chemical resistance • Cover plate required 	<ul style="list-style-type: none"> • PTFE 	-120°F (-85°C) to 400°F (204°C)	3.000 to 20.000 (76.2 to 508.0)	1,000 f/m (5.1 m/s)	Carbon steel garter	0.010 @ 500 (0.25 @ 2.5) 0.005 @ 1,000 (0.13 @ 5.1)	N/A
 <p>Model 26</p>	<ul style="list-style-type: none"> • High-performance seal • Solid or split design • Reverse bevel lip design prevents lip rollover • Reinforced rubber O.D. • Single and dual lip configurations available • Cover plate recommended for bore diameters over 10" 	<ul style="list-style-type: none"> • MILL-RIGHT® N • MILL-RIGHT® ES • MILL-RIGHT® V 	-40°F (-40°C) to 200°F (93°C) -40°F (-40°C) to 300°F (150°C) -22°F (-30°C) to 400°F (204°C)	0.750 to 60.000 (19.0 to 1524.0)	5,000 f/m (25.4 m/s)	Molded-in stainless steel finger	0.015 @ 1,000 (0.38 @ 5.1) 0.010 @ 2,000 (0.25 @ 10.2) 0.008 @ 5,000 (0.20 @ 25.4)	To 7 psi (0.4 bar) (N/A if split)
 <p>Model 26R1</p>	<ul style="list-style-type: none"> • High-performance dual lip seal • Reverse bevel lip design prevents lip rollover • Dust lip prevents ingress of light contaminants • Cover plate recommended for bore diameters over 10" 	<ul style="list-style-type: none"> • MILL-RIGHT® N • MILL-RIGHT® ES • MILL-RIGHT® V 	-40°F (-40°C) to 200°F (93°C) -40°F (-40°C) to 300°F (150°C) -22°F (-30°C) to 400°F (204°C)	0.750 to 60.000 (19.05 to 1524.0)	5,000 f/m (25.4 m/s)	Molded-in stainless steel finger	0.015 @ 1,000 (0.38 @ 5.1) 0.010 @ 2,000 (0.25 @ 10.2) 0.008 @ 5,000 (0.20 @ 25.4)	To 7 psi (0.4 bar) (N/A if split)
 <p>Model 151</p>	<ul style="list-style-type: none"> • General service seal • Solid or split design • Reinforced rubber OD • Cover plate required 	<ul style="list-style-type: none"> • Nitrile • Hydrogenated Nitrile • Fluoroelastomer 	-40°F (-40°C) to 200°F (93°C) -40°F (-40°C) to 300°F (150°C) -22°F (-30°C) to 400°F (204°C)	1.000 & up (25.4 & up)	2,000 f/m (10.2 m/s)	Carbon steel garter spring (NBR & HNBR) Stainless steel garter spring (FKM)	0.010 @ 2,000 (0.25 @ 10.2)	To 7 psi (0.4 bar) (N/A if split)
 <p>Model 154</p>	<ul style="list-style-type: none"> • General service seal • Solid or split design • Reinforced rubber OD • Reverse bevel lip design prevents lip roll over • Cover plate required 	<ul style="list-style-type: none"> • Nitrile • Hydrogenated Nitrile • Fluoroelastomer 	-40°F (-40°C) to 200°F (93°C) -40°F (-40°C) to 300°F (150°C) -22°F (-30°C) to 400°F (204°C)	1.000 & up (25.4 & up)	3,000 f/m (15.2 m/s)	Carbon steel garter spring (NBR & HNBR) Stainless steel garter spring (FKM)	0.010 @ 3,000 (0.25 @ 15.2)	To 7 psi (0.4 bar) (N/A if split)
 <p>Model 154R1</p>	<ul style="list-style-type: none"> • General service dual lip seal • Solid or split design • Reinforced rubber OD • Reverse bevel lip design prevents lip roll over • Dust lip prevents ingress of light contaminants • Cover plate required 	<ul style="list-style-type: none"> • Nitrile • Hydrogenated Nitrile • Fluoroelastomer 	-40°F (-40°C) to 200°F (93°C) -40°F (-40°C) to 300°F (150°C) -22°F (-30°C) to 400°F (204°C)	3.000 & up (76.2 & up)	3,000 f/m (15.2 m/s)	Carbon steel garter spring (NBR & HNBR) Stainless steel garter spring (FKM)	0.010 @ 3,000 (0.25 @ 15.2)	To 7 psi (0.4 bar) (N/A if split)





Excluder Seals	Features	Materials	Temp	Shaft Diameter in. (mm)	Surface Speed	Spring Type	Misalign. in. @ f/m (mm@m/s)	Pressure
 <p>Model 143A1</p>	<ul style="list-style-type: none"> • Face-type excluder seal† • Split design • High-speed service • Stainless steel clamp • Designed for 2.000 ±0.500" (50.8 ±12.7 mm) assembled width 	<ul style="list-style-type: none"> • Nitrile • Hydrogenated Nitrile • Fluoroelastomer 	-40°F (-40°C) to 200°F (93°C) -40°F (-40°C) to 300°F (150°C) -22°F (-30°C) to 400°F (204°C)	17.000 to 80.000 (431.8 to 2032.0)	5,000 f/m (25.4 m/s)	N/A	N/A	N/A
 <p>Model 143A2</p>	<ul style="list-style-type: none"> • Face-type excluder seal† • Split design • High-speed service • Designed for 0.781 ±0.156" (19.8 ±3.9 mm) assembled width 	<ul style="list-style-type: none"> • Nitrile • Hydrogenated Nitrile • Fluoroelastomer 	-40°F (-40°C) to 200°F (93°C) -40°F (-40°C) to 300°F (150°C) -22°F (-30°C) to 400°F (204°C)	6.000 to 80.000 (152.4 to 2032.0)	5,000 f/m (25.4 m/s)	N/A	N/A	N/A

Excluder Seals	Features	Materials	Temp	Shaft Diameter in. (mm)	Surface Speed	Spring Type	Misalign. in. @ f/m (mm@m/s)	Pressure
 <p>Model 144W1</p>	<ul style="list-style-type: none"> Contoured lip face-type excluder seal† Split design Excels in environments with heavy contamination and wash down Designed for 1.500 (38.1mm) assembled width 	<ul style="list-style-type: none"> MILL-RIGHT® N 	-40°F (-40°C) to 200°F (93°C)	17.000 to 75.500 (431.8 to 1917.7)	2,500 f/m (12.7 m/s)	N/A	N/A	N/A
 <p>Model 144W2</p>	<ul style="list-style-type: none"> Contoured lip face-type excluder seal† Split design Excels in environments with heavy contamination and wash down Designed for 1.250 (31.8mm) assembled width 	<ul style="list-style-type: none"> MILL-RIGHT® N 	-40°F (-40°C) to 200°F (93°C)	17.000 to 80.000 (431.8 to 2032.0)	2,500 f/m (12.7 m/s)	N/A	N/A	N/A
 <p>Model 145A</p>	<ul style="list-style-type: none"> Face-type excluder seal Flexible sealing lip provides continuous contact with perpendicular surfaces 	<ul style="list-style-type: none"> Nitrile Fluoroelastomer 	-40°F (-40°C) to 200°F (93°C) -22°F (-30°C) to 400°F (204°C)	0.110 to 8.272 (2.8 to 210.1)	2,500 f/m (12.7 m/s)	N/A	N/A	N/A
 <p>Model 145A1</p>	<ul style="list-style-type: none"> Face-type excluder seal Solid design High-speed service Designed for 2.000 ±0.500" (50.8 ±12.7 mm) assembled width 	<ul style="list-style-type: none"> Nitrile Hydrogenated Nitrile Fluoroelastomer 	-40°F (-40°C) to 200°F (93°C) -40°F (-40°C) to 300°F (150°C) -22°F (-30°C) to 400°F (204°C)	17.000 to 80.000 (431.8 to 2032.0)	5,000 f/m (25.4 m/s)	Stainless steel garter	N/A	N/A
 <p>Model 145A2</p>	<ul style="list-style-type: none"> Face-type excluder seal Solid design High-speed service Designed for 0.781 ±0.156" (19.8 ±3.9 mm) assembled width 	<ul style="list-style-type: none"> Nitrile Hydrogenated Nitrile Fluoroelastomer 	-40°F (-40°C) to 200°F (93°C) -40°F (-40°C) to 300°F (150°C) -22°F (-30°C) to 400°F (204°C)	7.000 to 80.000 (177.8 to 2032.0)	5,000 f/m (25.4 m/s)	Stainless steel garter	N/A	N/A
 <p>Model 145L</p>	<ul style="list-style-type: none"> Face-type excluder seal Flexible sealing lip provides continuous contact with perpendicular surfaces 	<ul style="list-style-type: none"> Nitrile Fluoroelastomer 	-40°F (-40°C) to 200°F (93°C) -22°F (-30°C) to 400°F (204°C)	5.320 to 18.700 (135.1 to 475.0)	2,500 f/m (12.7 m/s)	N/A	N/A	N/A
 <p>Model 145S</p>	<ul style="list-style-type: none"> Face-type excluder seal Flexible sealing lip provides continuous contact with perpendicular surfaces 	<ul style="list-style-type: none"> Nitrile Fluoroelastomer 	-40°F (-40°C) to 200°F (93°C) -22°F (-30°C) to 400°F (204°C)	0.181 to 8.272 (4.6 to 210.1)	2,500 f/m (12.7 m/s)	N/A	N/A	N/A







† Not recommended for rotating application (Seal should not rotate)

External Seals	Features	Materials	Temp	Shaft Diameter in. (mm)	Surface Speed	Spring Type	Misalign. in. @ f/m (mm@m/s)	Pressure
 <p>Model 26E</p>	<ul style="list-style-type: none"> General purpose external seal Solid design Reverse bevel lip design prevents lip rollover Reinforced rubber ID 	<ul style="list-style-type: none"> MILL-RIGHT® N MILL-RIGHT® ES MILL-RIGHT® V 	-40°F (-40°C) to 200°F (93°C) -40°F (-40°C) to 300°F (150°C) -22°F (-30°C) to 400°F (204°C)	1.000 to 60.000 (25.4 to 1524.0)	5,000 f/m (25.4 m/s)	Stainless steel finger	0.015 @ 1,000 (0.38 @ 5.1) 0.010 @ 2,000 (0.25 @ 10.2) 0.008 @ 5,000 (0.20 @ 25.4)	To 7 psi (0.4 bar)

External Seals	Features	Materials	Temp	Shaft Diameter in. (mm)	Surface Speed	Spring Type	Misalign. in. @ f/m (mm@m/s)	Pressure
 <p>Model 111</p> <ul style="list-style-type: none"> Heavy-duty metal case Low speed service Assembled design 	<ul style="list-style-type: none"> MILL-RIGHT® N MILL-RIGHT® ES MILL-RIGHT® V 	<p>-40°F (-40°C) to 200°F (93°C)</p> <p>-40°F (-40°C) to 300°F (150°C)</p> <p>-22°F (-30°C) to 400°F (204°C)</p>	<p>3.000 to 50.000 (76.2 to 1270.0)</p>	<p>1,000 f/m (5.1 m/s)</p>	<p>Stainless steel finger</p>	<p>0.010 @ 500 (0.25 @ 2.5)</p> <p>0.005 @ 1,000 (0.13 @ 5.1)</p>	<p>To 7 psi (0.4 bar)</p>	
 <p>Model 113</p> <ul style="list-style-type: none"> Heavy-duty metal case Assembled design 	<ul style="list-style-type: none"> MILL-RIGHT® N MILL-RIGHT® ES MILL-RIGHT® V 	<p>-40°F (-40°C) to 200°F (93°C)</p> <p>-40°F (-40°C) to 300°F (150°C)</p> <p>-22°F (-30°C) to 400°F (204°C)</p>	<p>3.000 to 50.000 (76.2 to 1270.0)</p>	<p>3,000 f/m (15.2 m/s)</p>	<p>Stainless steel finger</p>	<p>0.020 @ 1,000 (0.50 @ 5.1)</p> <p>0.010 @ 2,000 (0.25 @ 10.2)</p> <p>0.005 @ 3,000 (0.13 @ 15.2)</p>	<p>To 7 psi (0.4 bar)</p>	
 <p>Model 123</p> <ul style="list-style-type: none"> Heavy-duty metal case Assembled design 	<ul style="list-style-type: none"> MILL-RIGHT® N MILL-RIGHT® ES MILL-RIGHT® V 	<p>-40°F (-40°C) to 200°F (93°C)</p> <p>-40°F (-40°C) to 300°F (150°C)</p> <p>-22°F (-30°C) to 400°F (204°C)</p>	<p>1.156 to 50.000 (29.4 to 1270.0)</p>	<p>3,000 f/m (15.2 m/s)</p>	<p>Stainless steel finger</p>	<p>0.020 @ 1,000 (0.50 @ 5.1)</p> <p>0.010 @ 2,000 (0.25 @ 10.2)</p> <p>0.005 @ 3,000 (0.13 @ 15.2)</p>	<p>To 7 psi (0.4 bar)</p>	

Specialty Seals	Features	Materials	Temp	Shaft Diameter in. (mm)	Surface Speed	Spring Type	Misalign. in. @ f/m (mm@m/s)	Pressure
 <p>P/S®-I Single Lip</p> <ul style="list-style-type: none"> Assembled seal for high pressure applications GYLON® element offers excellent chemical resistance Dry running up to 800 fpm (3.5 m/s) 	<ul style="list-style-type: none"> GYLON® FDA GYLON® 	<p>-40°F (-40°C) to 400°F (204°C)</p>	<p>0.438 to 20.000 (11.1 to 508.0) max seal O.D.</p>	<p>2,000 f/m (10.2 m/s)</p>	<p>N/A</p>	<p>0.005 @ 2000 (0.13 @ 10.2)</p>	<p>To 150 psi (10 bar)</p>	
 <p>P/S®-I Single Lip Reverse</p> <ul style="list-style-type: none"> Assembled seal for high pressure applications GYLON® element offers excellent chemical resistance Dry running up to 800 fpm (3.5 m/s) 	<ul style="list-style-type: none"> GYLON® FDA GYLON® 	<p>-40°F (-40°C) to 400°F (204°C)</p>	<p>0.438 to 20.000 (11.1 to 508.0) max seal O.D.</p>	<p>2,000 f/m (10.2 m/s)</p>	<p>N/A</p>	<p>0.005 @ 2000 (0.13 @ 10.2)</p>	<p>To 150 psi (10 bar)</p>	
 <p>P/S®-I Dual Opposed</p> <ul style="list-style-type: none"> Assembled seal for high pressure applications GYLON® element offers excellent chemical resistance Dry running up to 800 fpm (3.5 m/s) 	<ul style="list-style-type: none"> GYLON® FDA GYLON® 	<p>-40°F (-40°C) to 400°F (204°C)</p>	<p>0.438 to 20.000 (11.1 to 508.0) max seal O.D.</p>	<p>2,000 f/m (10.2 m/s)</p>	<p>N/A</p>	<p>0.005 @ 2000 (0.13 @ 10.2)</p>	<p>To 150 psi (10 bar)</p>	
 <p>P/S®-I Dual Tandem</p> <ul style="list-style-type: none"> Assembled seal for high pressure applications GYLON® element offers excellent chemical resistance Dry running up to 800 fpm (3.5 m/s) 	<ul style="list-style-type: none"> GYLON® FDA GYLON® 	<p>-40°F (-40°C) to 400°F (204°C)</p>	<p>0.438 to 20.000 (11.1 to 508.0) max seal O.D.</p>	<p>2,000 f/m (10.2 m/s)</p>	<p>N/A</p>	<p>0.005 @ 2000 (0.13 @ 10.2)</p>	<p>To 150 psi (10 bar)</p>	

Oil Seals PRODUCT INFORMATION

Specialty Seals	Features	Materials	Temp	Shaft Diameter in. (mm)	Surface Speed	Spring Type	Misalign. in. @ f/m (mm@m/s)	Pressure
Model 26HR 	<ul style="list-style-type: none"> Special purpose seal for high misalignment applications Low-speed service Increased misalignment capability over standard 26 	<ul style="list-style-type: none"> MILL-RIGHT® N MILL-RIGHT® ES MILL-RIGHT® V 	-40°F (-40°C) to 200°F (93°C) -40°F (-40°C) to 300°F (150°C) -22°F (-30°C) to 400°F (204°C)	1.000 to 20.000 (25.4 to 508.0)	1,000 f/m (5.1 m/s)	Molded-in carbon steel garter	Application dependent	To 7 psi (0.4 bar)
Model 50 	<ul style="list-style-type: none"> Low-speed service Moderate pressure 	<ul style="list-style-type: none"> MILL-RIGHT® N 	-40°F (-40°C) to 200°F (93°C)	5.000 to 12.000 (127.0 to 304.8)	1,000 f/m (5.1 m/s)	Molded-in carbon steel garter spring	0.010 @ 1,000 (0.25 @ 12.7)	To 35 psi (2.4 bar)
Model 54 	<ul style="list-style-type: none"> Special purpose assembled seal Excluder seal Designed for spherical bearing surfaces - seal does not contact shaft 	<ul style="list-style-type: none"> MILL-RIGHT® N 	-40°F (-40°C) to 200°F (93°C)	For spherical radii from 2.375 to 13.438 (60.3 to 341.3)	1,000 f/m (5.1 m/s)	Stainless steel finger	N/A	To 50 psi (3.4 bar)
Model 57 	<ul style="list-style-type: none"> Metal reinforced rubber O.D. Reverse bevel lip design prevents lip rollover Available in single & dual lip Ideal for slow-speed service applications (i.e. continuous casters) 	<ul style="list-style-type: none"> MILL-RIGHT® N MILL-RIGHT® ES MILL-RIGHT® V 	-40°F (-40°C) to 200°F (93°C) -40°F (-40°C) to 300°F (150°C) -22°F (-30°C) to 400°F (204°C)	2.000 to 12.000 (50.8 to 304.8)	500 f/m (2.5 m/s)	Molded-in stainless steel finger	0.015 @ 500 (0.38 @ 2.5)	To 7 psi (0.4 bar)
Model 58 	<ul style="list-style-type: none"> High-temp, assembled seal THERMO-CERAM™ sealing element Ideal for abrasive environments Grease lubricated apps only 	<ul style="list-style-type: none"> THERMO-CERAM™ 	To 1600°F (871°C)	2.000 to 12.000 (50.8 to 304.8)	500 f/m (2.5 m/s)	N/A	0.015 @ 500 (0.38 @ 2.5)	Ambient
Model 62 	<ul style="list-style-type: none"> Assembled seal Solid design Low-speed service Excellent chemical resistance 	<ul style="list-style-type: none"> PTFE 	-120°F (-85°C) to 400°F (204°C)	0.437 to 20.000 (11.1 to 508.0) in max seal O.D.	2,000 f/m (10.2 m/s)	Carbon steel garter	0.005 @ 2,000 (0.13 @ 10.2)	To 7 psi (0.4 bar)

Most designs available without spring.
 Most designs available in silicone and other materials.

GUARDIAN™	GUARDIAN™	GUARDIAN™ Flangeless	GUARDIAN™ Narrow Width	GUARDIAN™ Small C-S	GUARDIAN™ SPB
	GUARDIAN™ Step Shaft	GUARDIAN™ Vertical	GUARDIAN™ Split	GUARDIAN™ Split SPB	

ISO-GARD®	ISO-GARD®	ISO-GARD® Dual O-Ring	ISO-GARD® Flangeless	ISO-GARD® Grease Purge	ISO-GARD® Small C-S
	ISO-GARD® SPB	ISO-GARD® Step Shaft	ISO-GARD® Vertical		

MICRO-TEC® II	MICRO-TEC® II	MICRO-TEC® II Flangeless	MICRO-TEC® II SPB	MICRO-TEC® II Small C-S	MICRO-TEC® II Vertical

EQUALIZER®	EQUALIZER®	EQUALIZER® Flangeless	EQUALIZER® Small C-S

C-S = Cross Section
 SPB = Split Pillow Block

Reference Dimensions

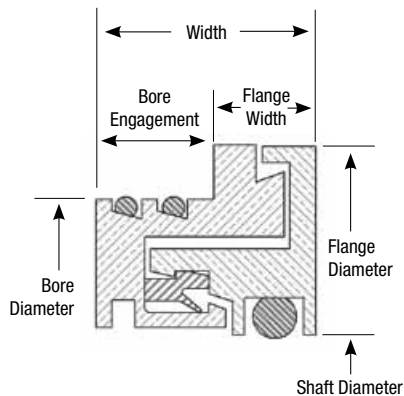

Typical Seal Configurations & Sizes

	Code Prefix	Description	Material	Width	Flange Width	Bore Engagement
GUARDIAN™	29602	Flanged	Bronze	0.700 (17.8 mm)	0.325 (8.3 mm)	0.375 (9.5 mm)
	29604	Flanged	316 Stainless Steel	0.700 (17.8 mm)	0.325 (8.3 mm)	0.375 (9.5 mm)
	29606	Small Cross Section	316 Stainless Steel	0.625 (15.9 mm)	0.375 (9.5 mm)	0.250 (6.4 mm)
	29607	Small Cross Section	Bronze	0.625 (15.9 mm)	0.375 (9.5 mm)	0.250 (6.4 mm)
	29608	Small Cross Section, Short Flange	Bronze	0.625 (15.9 mm)	0.250 (6.4 mm)	0.375 (9.5 mm)
	29609	Narrow Width Flangeless	Bronze	0.375 (9.5 mm)	N/A	0.375 (9.5 mm)
	29610	Small Flanged	Bronze	0.700 (17.8 mm)	0.325 (8.3 mm)	0.375 (9.5 mm)
	29611	Narrow Width Flangeless	316 Stainless Steel	0.375 (9.5 mm)	N/A	0.375 (9.5 mm)
	29612	Flangeless	316 Stainless Steel	0.625 (15.9 mm)	N/A	0.625 (15.9 mm)
	29616	Split Pillow Block	Bronze	Various*	0.500 (12.7 mm)*	Various*
	29617	Split Pillow Block	316 Stainless Steel	Various*	0.500 (12.7 mm)*	Various*
	29619	Flangeless	Bronze	0.625 (15.9 mm)	N/A	0.625 (15.9 mm)
	29620	Vertical	Bronze	0.700 (17.8 mm)	0.325 (8.3 mm)	0.375 (9.5 mm)
	29621	Vertical - Small Cross Section	Bronze	0.625 (15.9 mm)	0.375 (9.5 mm)	0.250 (6.4 mm)
	29622	Vertical	316 Stainless Steel	0.700 (17.8 mm)	0.325 (8.3 mm)	0.375 (9.5 mm)
29623	Vertical - Small Cross Section	316 Stainless Steel	0.625 (15.9 mm)	0.375 (9.5 mm)	0.250 (6.4 mm)	

Split GUARDIAN™	Code Prefix	Description	Material	Width	Flange Width	Bore Engagement
	29702	Flanged	Bronze	1.150 (29.2 mm)	0.775 (19.7 mm)	0.375 (9.5 mm)
	29716	Split Pillow Block	Bronze	Various*	0.775 (19.7 mm)*	Various*

	Code Prefix	Description	Material	Width	Flange Width	Bore Engagement
MICRO-TEC® II	29102	Flanged	Bronze	0.700 (17.8 mm)	0.325 (8.3 mm)	0.375 (9.5 mm)
	29104	Small Cross Section	316 Stainless Steel	0.625 (15.9 mm)	0.375 (8.3 mm)	0.250 (6.4 mm)
	29106	Flanged	316 Stainless Steel	0.700 (17.8 mm)	0.325 (8.3 mm)	0.375 (9.5 mm)
	29107	Small Cross Section	Bronze	0.625 (15.9 mm)	0.375 (9.5 mm)	0.250 (6.4 mm)
	29112	Flangeless	316 Stainless Steel	0.625 (15.9 mm)	N/A	0.625 (15.9 mm)
	29116	Split Pillow Block	Bronze	Various*	0.500 (12.7 mm)*	Various*
	29117	Split Pillow Block	316 Stainless Steel	Various*	0.500 (12.7 mm)*	Various*
	29119	Flangeless	Bronze	0.625 (15.9 mm)	N/A	0.625 (15.9 mm)
	29120	Vertical	Bronze	0.700 (17.8 mm)	0.325 (8.3 mm)	0.375 (9.5 mm)
	29121	Vertical - Small Cross Section	Bronze	0.625 (15.9 mm)	0.375 (9.5 mm)	0.250 (6.4 mm)
	29122	Vertical	316 Stainless Steel	0.700 (17.8 mm)	0.325 (8.3 mm)	0.375 (9.5 mm)
	29123	Vertical - Small Cross Section	316 Stainless Steel	0.625 (15.9 mm)	0.375 (9.5 mm)	0.250 (6.4 mm)







	Code Prefix	Description	Material	Width	Flange Width	Bore Engagement
ISO-GARD®	29500	Flanged 2 O.D. O-Rings	Glass Filled PTFE	0.750 (19.1 mm)	0.250 (6.4 mm)	0.500 (12.7 mm)
	29502	Flanged	Glass Filled PTFE	0.750 (19.1 mm)	0.375 (9.5 mm)	0.375 (9.5 mm)
	29507	Small Cross Section	Glass Filled PTFE	0.625 (15.9 mm)	0.375 (9.5 mm)	0.250 (6.4 mm)
	29516	Split Pillow Block	Glass Filled PTFE	Various*	0.500 (12.7 mm)*	Various*
	29518	Grease Purgeable	Glass Filled PTFE	0.820 (20.8 mm)	0.320 (8.1 mm)	0.500 (12.7 mm)
	29519	Flangeless	Glass Filled PTFE	0.640 (16.3 mm)	N/A	0.640 (16.3 mm)
	29520	Vertical	Glass Filled PTFE	0.760 (19.3 mm)	0.385 (9.8 mm)	0.375 (9.5 mm)
	29521	Vertical - Two O.D. O-Rings	Glass Filled PTFE	0.885 (22.5 mm)	0.385 (9.8 mm)	0.500 (12.7 mm)

	Code Prefix	Description	Material	Width	Flange Width	Bore Engagement
Equalizer®	24801	Flangeless	Graphite Filled PTFE	0.625 (15.9 mm)	N/A	0.625 (15.9 mm)
	24802	Flanged	Graphite Filled PTFE	0.625 (15.9 mm)	0.250 (6.4 mm)	0.375 (9.5 mm)
	24807	Small Cross Section	Graphite Filled PTFE	0.690 (17.5 mm)	0.375 (9.5 mm)	0.315 (8.0 mm)

NOTE:

- Flange width is a reference dimension depending on installation and misalignment at application

* Pillow Block Dependant



GUARDIAN™ Model Number	Features	Materials	IP Rating	Temp*	Shaft Diameter in. (mm)**	Surface Speed	Axial Motion in. (mm)	Misalign. & Runout in. (mm)	Pressure
Flanged 29602, 29604 	<ul style="list-style-type: none"> Meets NEMA MG 1-2003 Surpasses IEEE 841-2001 test standards Conforms to API 610 (Bronze only) No arbor press required for installation No internal metal-to-metal contact 	<ul style="list-style-type: none"> Bronze or 316 stainless steel construction Filled PTFE unitizing ring Fluoroelastomer O-rings standard 	IP 56	-22°F (-30°C) to 400°F (204°C)	0.875 to 10.500 (22.2 to 266.7)	12,000 f/m (60.9 m/s)	±0.025 (0.64)	±0.020 (0.51)	Ambient
Small Cross Section 29606, 29607, 29608 	<ul style="list-style-type: none"> Meets NEMA MG 1-2003 Meets IEEE 841-2001 test standards Conforms to API 610 (Bronze only) No arbor press required for installation No internal metal-to-metal contact Fits in c/s as small as 0.188" (4.76mm) 	<ul style="list-style-type: none"> Bronze or 316 stainless steel construction Filled PTFE unitizing ring Fluoroelastomer O-rings standard 	IP 55	-22°F (-30°C) to 400°F (204°C)	0.875 to 5.500 (22.2 to 139.7)	12,000 f/m (60.9 m/s)	±0.015 (0.38)	±0.010 (0.25)	Ambient
Flangeless Narrow Width 29609, 29611 	<ul style="list-style-type: none"> Meets NEMA MG 1-2003 Meets IEEE 841-2001 test standards Conforms to API 610 (Bronze only) No arbor press required for installation No internal metal-to-metal contact Flangeless design fits in spaces as narrow as 0.375" (9.53mm) 	<ul style="list-style-type: none"> Bronze or 316 stainless steel construction Filled PTFE unitizing ring Fluoroelastomer O-rings standard 	IP 55	-22°F (-30°C) to 400°F (204°C)	0.875 to 4.000 (22.2 to 139.7)	12,000 f/m (60.9 m/s)	±0.015 (0.38)	±0.010 (0.25)	Ambient
Flangeless 29612, 29619 	<ul style="list-style-type: none"> Meets NEMA MG 1-2003 Meets IEEE 841-2001 test standards Conforms to API 610 (Bronze only) No arbor press required for installation No internal metal-to-metal contact Does not extend past face of housing 	<ul style="list-style-type: none"> Bronze or 316 stainless steel construction Filled PTFE unitizing ring Fluoroelastomer O-rings standard 	IP 55	-22°F (-30°C) to 400°F (204°C)	0.875 to 10.500 (22.2 to 266.7)	12,000 f/m (60.9 m/s)	±0.025 (0.64)	±0.020 (0.51)	Ambient
Split Pillow Block 29616, 29617*** 	<ul style="list-style-type: none"> Meets NEMA MG 1-2003 Surpasses IEEE 841-2001 test standards Conforms to API 610 (Bronze only) No arbor press required for installation No internal metal-to-metal contact Standard and custom design for split pillow blocks 	<ul style="list-style-type: none"> Bronze or 316 stainless steel construction Filled PTFE unitizing ring Fluoroelastomer O-rings standard 	IP 56	-22°F (-30°C) to 400°F (204°C)	0.875 to 10.500 (22.2 to 266.7)	12,000 fpm (60.9 m/s)	±0.025 (0.64)	±0.020 (0.51)	Ambient
Step Shaft 29697 	<ul style="list-style-type: none"> Meets NEMA MG 1-2003 Conforms to API 610 (Bronze only) No arbor press required for installation No internal metal-to-metal contact Custom designed for individual step shaft applications 	<ul style="list-style-type: none"> Bronze or 316 stainless steel construction Filled PTFE unitizing ring Fluoroelastomer O-rings standard 	(N/A)	-22°F (-30°C) to 400°F (204°C)	0.875 to 10.500 (22.2 to 266.7)	12,000 fpm (60.9 m/s)	±0.025 (0.64)	±0.020 (0.51)	Ambient
Vertical 29620, 29621, 29622, 29623 	<ul style="list-style-type: none"> Meets NEMA MG 1-2003 Surpasses IEEE 841-2001 test standards Conforms to API 610 (Bronze only) No arbor press required for installation No internal metal-to-metal contact Fits in c/s as small as 0.188 in. (4.76mm) Vertical design for top applications only 	<ul style="list-style-type: none"> Bronze or 316 stainless steel construction Filled PTFE unitizing ring Fluoroelastomer O-rings standard 	29620 IP 56 29621 IP 55	-22°F (-30°C) to 400°F (204°C)	0.875 to 10.500 (22.2 to 266.7)	12,000 fpm (60.9 m/s)	Std: ±0.025 (0.64) Small C/S: ±0.015 (0.38)	Std: ±0.020 (0.51) Small C/S: ±0.010 (0.25)	Ambient

* Temperature rating based on standard fluoroelastomer o-rings

** For larger or smaller shaft diameters, please contact Klozure®.

*** Solid seal for split pillow block application



Bearing Isolators PRODUCT INFORMATION

Split GUARDIAN™ Model Number	Features	Materials	IP Rating	Temp*	Shaft Diameter in. (mm)**	Surface Speed	Axial Motion in. (mm)	Misalign. & Runout in. (mm)	Pressure
Flanged 29702 	<ul style="list-style-type: none"> Meets NEMA MG 1-2003 Surpasses IEEE 841-2001 test standards Conforms to API 610 (Bronze only) No arbor press required for installation No internal metal-to-metal contact Split design allows for installation without disassembly of equipment 	<ul style="list-style-type: none"> Bronze or 316 stainless steel construction Filled PTFE unitizing ring Fluoroelastomer O-rings standard 	IP 55	-22°F (-30°C) to 400°F (204°C)	0.875 to 10.500 (22.2 to 266.7)	4,500 f/m (22.9 m/s)	±0.025 (0.64)	±0.020 (0.51)	Ambient
Split Pillow Block 29716*** 	<ul style="list-style-type: none"> Meets NEMA MG 1-2003 Surpasses IEEE 841-2001 test standards Conforms to API 610 (Bronze only) No arbor press required for installation No internal metal-to-metal contact Standard and custom design for split pillow blocks Split design allows for installation without disassembly of equipment 	<ul style="list-style-type: none"> Bronze or 316 stainless steel construction Filled PTFE unitizing ring Fluoroelastomer O-rings standard 	IP 55	-22°F (-30°C) to 400°F (204°C)	0.875 to 10.500 (22.2 to 266.7)	4,500 f/m (22.9 m/s)	±0.025 (0.64)	±0.020 (0.51)	Ambient

* Temperature rating based on standard fluoroelastomer o-rings



** For larger or smaller shaft diameters, please contact Klozure®.

*** Split seal for split pillow block application.

MICRO-TEC® II Model Number	Features	Materials	IP Rating	Temp*	Shaft Diameter in. (mm)**	Surface Speed	Axial Motion in. (mm)	Misalign. & Runout in. (mm)	Pressure
Flanged 29102, 29106 	<ul style="list-style-type: none"> Unique microcellular technology Protects against severely dusty environments Meets NEMA MG 1-2003 Surpasses IEEE 841-2001 test standards Conforms to API 610 (Bronze only) No arbor press required for installation No internal metal-to-metal contact 	<ul style="list-style-type: none"> Bronze or 316 stainless steel construction Silicone foam Filled PTFE Unitizing Ring Fluoroelastomer O-rings standard 	IP 56	-22°F (-30°C) to 400°F (204°C)	0.875 to 11.000 (22.2 to 279.4)	4,500 f/m (22.9 m/s)	±0.025 (0.64)	±0.020 (0.51)	Ambient
Small Cross Section 29104, 29107 	<ul style="list-style-type: none"> Unique microcellular technology Protects against severely dusty environments Meets NEMA MG 1-2003 Meets IEEE 841-2001 test standards Conforms to API 610 (Bronze only) No arbor press required for installation No internal metal-to-metal contact Fits in c/s as small as 0.188" (4.76mm) 	<ul style="list-style-type: none"> Bronze or 316 stainless steel construction Silicone foam Filled PTFE Unitizing Ring Fluoroelastomer O-rings standard 	IP 55	-22°F (-30°C) to 400°F (204°C)	0.875 to 11.000 (22.2 to 279.4)	4,500 f/m (22.9 m/s)	±0.015 (0.38)	±0.010 (0.25)	Ambient
Flangeless 29112, 29119 	<ul style="list-style-type: none"> Unique microcellular technology Protects against severely dusty environments Meets NEMA MG 1-2003 Meets IEEE 841-2001 test standards Conforms to API 610 (Bronze only) No arbor press required for installation No internal metal-to-metal contact Does not extend past face of housing 	<ul style="list-style-type: none"> Bronze or 316 stainless steel construction Silicone foam Filled PTFE Unitizing Ring Fluoroelastomer O-rings standard 	IP 55	-22°F (-30°C) to 400°F (204°C)	0.875 to 11.000 (22.2 to 279.4)	4,500 f/m (22.9 m/s)	±0.025 (0.64)	±0.020 (0.51)	Ambient

* Temperature rating based on standard fluoroelastomer o-rings





** For larger or smaller shaft diameters, please contact Klozure®.

MICRO-TEC® II Model Number	Features	Materials	IP Rating	Temp*	Shaft Diameter in. (mm)**	Surface Speed	Axial Motion in. (mm)	Misalign. & Runout in. (mm)	Pressure
Split Pillow Block 29116, 29117*** 	<ul style="list-style-type: none"> Unique microcellular technology Protects against severely dusty environments Meets NEMA MG 1-2003 Surpasses IEEE 841-2001 test standards Conforms to API 610 (Bronze only) No arbor press required for installation No internal metal-to-metal contact Standard and custom design for split pillow blocks 	<ul style="list-style-type: none"> Bronze or 316 stainless steel construction Silicone foam Filled PTFE Unitizing Ring Fluoroelastomer O-rings standard 	IP 56	-22°F (-30°C) to 400°F (204°C)	0.875 to 11.000 (22.2 to 279.4)	4,500 f/m (22.9 m/s)	±0.025 (0.64)	±0.020 (0.51)	Ambient
Vertical 29120, 29121, 29122, 29123 	<ul style="list-style-type: none"> Unique microcellular technology Protects against severely dusty environments Meets NEMA MG 1-2003 Surpasses IEEE 841-2001 test standards Conforms to API 610 (Bronze only) No arbor press required for installation No internal metal-to-metal contact Standard and custom design for split pillow blocks 	<ul style="list-style-type: none"> Bronze or 316 stainless steel construction Silicone foam Filled PTFE Unitizing Ring Fluoroelastomer O-rings standard 	Std: IP 56 Small c/s: IP 55	-22°F (-30°C) to 400°F (204°C)	0.875 to 11.000 (22.2 to 279.4)	4,500 f/m (22.9 m/s)	Std: ±0.025 (0.64) Small c/s: ±0.015 (0.38)	Std: ±0.020 (0.51) Small c/s: ±0.010 (0.25)	Ambient



* Temperature rating based on standard fluoroelastomer o-rings

** For larger or smaller shaft diameters, please contact Klozure®.

*** Split seal for split pillow block application.



ISO-GARD® Model Number	Features	Materials	IP Rating	Temp*	Shaft Diameter in. (mm)**	Surface Speed	Axial Motion in. (mm)	Misalign. & Runout in. (mm)	Pressure
Flanged 29500, 29502 	<ul style="list-style-type: none"> Filled PTFE construction Excellent chemical resistance Meets NEMA MG 1-2003 Meets IEEE 841-2001 test standards No arbor press required for installation 	<ul style="list-style-type: none"> FDA compliant blue glass filled PTFE Fluoroelastomer O-rings standard 	IP 55	-22°F (-30°C) to 400°F (204°C)	0.875 to 11.000 (22.2 to 279.4)	4,500 f/m (22.9 m/s)	±0.015 (0.38)	±0.020 (0.51)	Ambient
Small Cross Section 29507 	<ul style="list-style-type: none"> Filled PTFE construction Excellent chemical resistance Meets NEMA MG 1-2003 Meets IEEE 841-2001 test standards No arbor press required for installation Fits in c/s as small as 0.188" (4.76mm) 	<ul style="list-style-type: none"> FDA compliant blue glass filled PTFE Fluoroelastomer O-rings standard 	IP 55	-22°F (-30°C) to 400°F (204°C)	0.875 to 11.000 (22.2 to 279.4)	4,500 f/m (22.9 m/s)	±0.015 (0.38)	±0.020 (0.51)	Ambient
Flangeless 29519 	<ul style="list-style-type: none"> Filled PTFE construction Excellent chemical resistance Meets NEMA MG 1-2003 Meets IEEE 841-2001 test standards No arbor press required for installation Does not extend past face of housing 	<ul style="list-style-type: none"> FDA compliant blue glass filled PTFE Fluoroelastomer O-rings standard 	IP 55	-22°F (-30°C) to 400°F (204°C)	0.875 to 11.000 (22.2 to 279.4)	4,500 f/m (22.9 m/s)	±0.015 (0.38)	±0.020 (0.51)	Ambient
Grease Purgeable 29518 	<ul style="list-style-type: none"> Filled PTFE construction Excellent chemical resistance Meets NEMA MG 1-2003 Meets IEEE 841-2001 test standards No arbor press required for installation Relief in seal allows regreasing with no disassembly of equipment 	<ul style="list-style-type: none"> FDA compliant blue glass filled PTFE Fluoroelastomer O-rings standard 	IP 55	-22°F (-30°C) to 400°F (204°C)	0.875 to 11.000 (22.2 to 279.4)	4,500 f/m (22.9 m/s)	±0.015 (0.38)	±0.020 (0.51)	5 psi
Split Pillow Block 29516 	<ul style="list-style-type: none"> Filled PTFE construction Excellent chemical resistance Meets NEMA MG 1-2003 Meets IEEE 841-2001 test standards No arbor press required for installation Standard and custom design for split pillow blocks 	<ul style="list-style-type: none"> FDA compliant blue glass filled PTFE Fluoroelastomer O-rings standard 	IP 55	-22°F (-30°C) to 400°F (204°C)	0.875 to 11.000 (22.2 to 279.4)	4,500 f/m (22.9 m/s)	±0.015 (0.38)	±0.020 (0.51)	Ambient

Bearing Isolators PRODUCT INFORMATION

ISO-GARD® Model Number	Features	Materials	IP Rating	Temp	Shaft Diameter in. (mm)**	Surface Speed	Axial Motion in. (mm)	Misalign. & Runout in. (mm)	Pressure
Step Shaft 29597 	<ul style="list-style-type: none"> Filled PTFE construction Excellent chemical resistance Meets NEMA MG 1-2003 Meets IEEE 841-2001 test standards No arbor press required for installation Custom designed for individual stepshaft applications 	<ul style="list-style-type: none"> FDA compliant blue glass filled PTFE Fluoroelastomer O-rings standard 	IP 55	-22°F (-30°C) to 400°F (204°C)	0.875 to 11.000 (22.2 to 279.4)	4,500 f/m (22.9 m/s)	±0.015 (0.38)	±0.020 (0.51)	Ambient
Vertical 29520, 29521 	<ul style="list-style-type: none"> Filled PTFE construction Excellent chemical resistance Meets NEMA MG 1-2003 Meets IEEE 841-2001 test standards No arbor press required for installation Style 29521 offers two O.D. O-Rings for increased retention in the bore Vertical design for top applications only 	<ul style="list-style-type: none"> FDA compliant blue glass filled PTFE Fluoroelastomer O-rings standard 	IP 55	-22°F (-30°C) to 400°F (204°C)	0.875 to 11.000 (22.2 to 279.4)	4,500 f/m (22.9 m/s)	±0.015 (0.38)	±0.020 (0.51)	Ambient

* Temperature rating based on standard fluoroelastomer o-rings

** For larger or smaller shaft diameters, please contact Klozure®.

EQUALIZER® Model Number	Features	Materials	IP Rating	Temp	Shaft Diameter in. (mm)**	Surface Speed	Axial Motion in. (mm)	Misalign. & Runout in. @ f/m (mm@m/s)	Pressure
Flanged 24802 	<ul style="list-style-type: none"> Excellent chemical resistance Multi-position capability No arbor press required for installation Unique pumping/fanning action 	<ul style="list-style-type: none"> Graphite-filled PTFE Fluoroelastomer O-rings standard 	(N/A)	-22°F (-30°C) to 400°F (204°C)	0.875 to 6.000 (22.2 to 152.4)	4,500 f/m (22.9 m/s)	±0.015 (0.38)	±0.015 (0.38)	Ambient
Small Cross Section 24807 	<ul style="list-style-type: none"> Excellent chemical resistance Multi-position capability No arbor press required for installation Unique pumping/fanning action Designed to fit small c/s with no equipment modification 	<ul style="list-style-type: none"> Graphite-filled PTFE Fluoroelastomer O-rings standard 	(N/A)	-22°F (-30°C) to 400°F (204°C)	0.875 to 10.500 (22.2 to 266.7)	4,500 f/m (22.9 m/s)	±0.015 (0.38)	±0.015 (0.38)	Ambient
Flangeless 24801 	<ul style="list-style-type: none"> Excellent chemical resistance Multi-position capability No arbor press required for installation Unique pumping/fanning action Does not extend past face of housing 	<ul style="list-style-type: none"> Graphite-filled PTFE Fluoroelastomer O-rings standard 	(N/A)	-22°F (-30°C) to 400°F (204°C)	0.875 to 6.000 (22.2 to 152.4)	4,500 f/m (22.9 m/s)	±0.015 (0.38)	±0.015 (0.38)	Ambient

* Temperature rating based on standard fluoroelastomer o-rings

** For larger or smaller shaft diameters, please contact Klozure®.

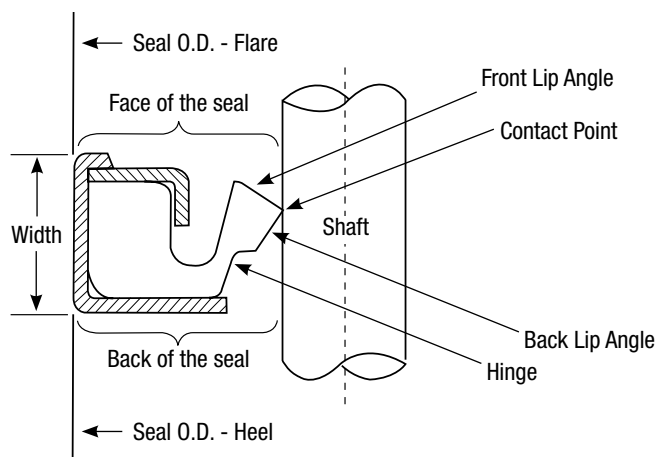

ASSEMBLED SEAL:	A group of parts, which includes sealing surface(s), provisions for initial loading, and a secondary sealing mechanism that accommodates the radial movement necessary for installation and operation.	FACE LIP ANGLE:	The angle seen from the face of the seal coincident of the seal interface.
AXIAL CLEARANCE:	The gap between the element heel and seal lip.	FLUID SIDE:	Typically, referred to the face of the seal when the primary sealing objective is to retain lubricant, but can be the back of the seal when the primary sealing objective is to exclude contamination.
BACK LIP ANGLE:	The angle seen from the back of the seal coincident of the seal interface.	GARTER SPRING:	A helically coiled wire with its ends connected to form a ring. Close wound can be used in tension or open wound used in compression for maintaining a radial sealing force between the element of a radial lip seal and a shaft or bore.
BEARING ISOLATOR:	Sealing technology that uses labyrinth sealing methods in conjunction with other methods to provide a high-performance sealing solution.	HEEL:	The portion of a lip seal case located tangent to the back of the seal.
BONDED SEAL:	Seal assembly where the insert and/or spring is bonded to the elastomer element.	HINGE:	The point at which the seal lip pivots about the seal assembly.
CONTACT POINT:	The interface where the sealing element reacts dynamically with the shaft or bore housing.	HOUSING BORE:	A cylindrical surface which mates with the outside diameter of the seal outer case (standard lip seal) or the external contact lip (external lip seal).
CONTACT LINE HEIGHT:	The axial distance from the seal face to the contact point.	INCLUSION:	Retaining lubricant by facing the seal in toward the lubricant.
CONTACT WIDTH:	The amount of area that is reacting dynamically in the axial direction.	INNER CASE:	A rigid, cup shaped component of a seal assembly used as one or more of the following: reinforcing member, shield, spring retainer, and lip-clamping device.
DYNAMIC RUNOUT:	Twice the distance the center of the shaft is displaced from the center of rotation and expressed in TIR. That runout to which the seal lip is subjected due to the outside diameter of the shaft not rotating in a true circle.	LABYRINTH SEAL:	Seal which uses a torturous pathway to both exclude debris & retain lubricant.
ELASTOMER:	Synthetic and natural products able to be vulcanized and capable of being elongated at least double their original length at room temperature but return to their approximate length when released.	LIP DIAMETER:	The most inner diameter of the seal lip, measured with the spring installed.
END PLAY:	A measure of axial movement encountered or allowed, usually in reference to the shaft on which the seal lip contacts.	LIP LOAD:	The radial force exerted by the seal lip geometry as well as any spring loading. Lip load is expressed as force per unit of shaft circumference.
		LIP SEAL:	An elastomeric element which prevents leakage in dynamic and static applications through means of geometry and loading.
		LUBRICANT STARVATION:	Lack of proper lubrication at the seal interface which may cause premature wear.
		MILL-RIGHT® ES:	A Garlock Klokzure proprietary formulation of Hydrogenated Nitrile (HNBR). Engineered specifically for high-performance applications that demand the tightest sealing system, the longest service life, and constant operation within extremely harsh chemical environments. Hydrogenated nitrile is the general name for hydrogenated acrylonitrile butadiene terpolymer.

MILL-RIGHT® N:	A Garlock Klozure proprietary formulation of Nitrile (NBR). Engineered specifically for high-performance applications that demand the tightest sealing system, the longest service life, and constant operation within extremely harsh chemical environments. Nitrile is the general name for acrylonitrile butadiene terpolymer.	SHAFT LEAD:	Helical grooves on a shaft surface caused by relative axial movement of the grinding wheel to shaft.
MILL-RIGHT® V:	A Garlock Klozure proprietary formulation of Fluoroelastomer (FKM). Engineered specifically for high-performance applications that demand the tightest sealing system, the longest service life, and constant operation within extremely harsh chemical environments. Fluoroelastomer is the general name for vinylidene fluoride and hexafluoropropylene copolymer.	“SLIP-STICK”:	A friction related phenomena in which the sealing element tends to adhere and rotate with the shaft surface momentarily until the elastic characteristics of the sealing element overcome the adhesive force, causing the seal lip to lose contact with the rotating surface long enough to allow leakage. This cycle repeats itself continuously and is normally associated with non-lubricated and boundary-lubricated conditions.
OFFSET:	The radial distance between centerline of seal bore and the centerline of the shaft rotation.	SPRING GROOVE:	A depression formed in the head section of the seal. It is generally semicircular in form and serves to accommodate and locate the garter spring.
OUTER CASE:	The rigid structure of the lip-seal assembly which houses all components of the seal assembly.	SPRING RETAINING LIP:	The portion of the primary lip that restricts the axial movement of the extension spring from a predetermined position.
PLUNGE GROUND:	The surface texture of a shaft or wear sleeve produced by introducing a grinding wheel perpendicular to the rotating shaft without axial motion.	SURFACE FINISH:	A term used to describe the quality, appearance, and/or characteristics of the shaft surface resulting from operations such as grinding, polishing, burnishing, etc. See SAE J488a (June, 1963) for additional information.
PRIMARY LIP:	The elastomeric sealing element which typically rides against the rotating surface facing in toward the lubricant for lubricant inclusion or out away from the lubricant for contamination exclusion.	UNIDIRECTIONAL/ UNIROTATIONAL SEAL:	A seal designed for applications having a single direction of shaft rotation.
RADIAL LIP SEAL:	An assembly containing an elastomeric element which prevents leakage in dynamic and static applications through means of geometry and loading.	UNITIZED SEAL:	A seal assembly in which all components necessary for accomplishing the complete sealing function are retained in a single package.
RADIAL LOAD:	The radial force exerted by the seal lip geometry as well as any spring loading. Lip load is expressed as force per unit of shaft circumference.	VOLUME SWELL:	Increase in physical size caused by the absorption of the fluid the elastomer is immersed in.
ROUGHNESS:	Irregularities in shaft surface texture which result from the production process. (See SAE J448a [June, 1963].)	WEAR SLEEVE:	A replaceable metal sleeve generally used in assemblies to eliminate expensive shaft replacement due to grooving from contamination at the seal-shaft interface.
SEAL CASE:	A rigid member to which the elastomeric element is attached.	WEEPAGE:	A minute amount of liquid leakage by a seal.
SEAL OUTER DIAMETER (O.D.):	The external diameter of a lip seal assembly, which interfaces with the housing bore diameter.		
SHAFT ECCENTRICITY:	The radial distance which the geometric centerline of the shaft is displaced from the axis of shaft rotation.		

Model	Prefix	Seal Material	Description
21	25001	MILL-RIGHT N	SPLIT
	25002	SILICONE	SPLIT
	25008	MILL-RIGHT V	SPLIT
	25018	MILL-RIGHT ES	SPLIT
23	25003	MILL-RIGHT N	SPLIT
	25004	SILICONE	SPLIT
	25006	MILL-RIGHT V	SPLIT
	25010	MILL-RIGHT ES	SPLIT
24	25005	MILL-RIGHT N	SPLIT
	25029	MILL-RIGHT ES	SPLIT
	25030	MILL-RIGHT V	SPLIT
25	25056	PTFE	SOLID
	25058	PTFE	SPLIT
26	24600	MILL-RIGHT N	SOLID
	24602	MILL-RIGHT V	SOLID
	24610	MILL-RIGHT N	SPLIT
	24612	MILL-RIGHT V	SPLIT
	24626	MILL-RIGHT ES	SOLID
	24627	MILL-RIGHT ES	SPLIT
26E	24640	MILL-RIGHT N	SOLID
	24675	MILL-RIGHT ES	SOLID
	24642	MILL-RIGHT V	SOLID
26HR	24656	MILL-RIGHT ES	HIGH RUNOUT, SPLIT
	24660	MILL-RIGHT N	HIGH RUNOUT
	24662	MILL-RIGHT V	HIGH RUNOUT
	24663	MILL-RIGHT N	HIGH RUNOUT, SPLIT
	24664	MILL-RIGHT ES	HIGH RUNOUT, SOLID
26NS	24650	MILL-RIGHT N	NO SPRING
	24652	MILL-RIGHT V	NO SPRING
26R1	24606	MILL-RIGHT V	DUAL LIP, SPLIT
	24608	MILL-RIGHT N	DUAL LIP, SPLIT
	24620	MILL-RIGHT N	DUAL LIP, SOLID
	24622	MILL-RIGHT V	DUAL LIP, SOLID
	24629	MILL-RIGHT ES	DUAL LIP, SOLID
	24648	MILL-RIGHT ES	DUAL LIP, SPLIT
50	21020	MILL-RIGHT N	GARTER SPRING
51	21022	MILL-RIGHT N	CARBON STEEL CASE W/ METAL BUTTONS
	21486	MILL-RIGHT N	BRASS CASE W/ METAL BUTTONS
	21619	MILL-RIGHT N	BRASS CASE, NO BUTTONS
53	21086	MILL-RIGHT N	STD
	21095	SILICONE	STD
	21096	MILL-RIGHT ES	STD
	21699	MILL-RIGHT V	STD

Model	Prefix	Seal Material	Description
53F1	22987	MILL-RIGHT N	STD
53G1	22500	MILL-RIGHT N	STD
	22501	MILL-RIGHT ES	STD
	22502	MILL-RIGHT V	STD
53R1	22537	MILL-RIGHT N	STD
	22544	MILL-RIGHT ES	STD
	22543	MILL-RIGHT V	STD
53R2	22627	MILL-RIGHT N	STD
	22634	MILL-RIGHT ES	STD
	23708	MILL-RIGHT V	STD
53T2	22897	MILL-RIGHT N	STD
	22903	MILL-RIGHT V	STD
54	21140	MILL-RIGHT N	STD
57	26056	MILL-RIGHT N	STD
	26057	MILL-RIGHT V	STD
	26058	MILL-RIGHT ES	STD
58	21003	THERMO-CERAM	STD
	21005	THERMO-CERAM	316 SS CASE
59	24700	MILL-RIGHT N	STD
	24702	MILL-RIGHT V	STD
	24715	MILL-RIGHT ES	STD
59G1	24750	MILL-RIGHT N	GYLON EXCLUDER LIP
	24751	MILL-RIGHT ES	GYLON EXCLUDER LIP
	24752	MILL-RIGHT V	GYLON EXCLUDER LIP
P/S® I	24056	FDA GYLON	REVERSE LIP
	24060	GYLON	GYLON LIP , FLUORO GSKT
	24062	GYLON	DBL TANDEM , GYLON LIP, FLUORO GSKT
	24063	GYLON	DBL OPPOSED , GYLON LIP, FLUORO GSKT
	24064	GYLON	REVERSE LIP
	24076	FDA GYLON	DBL OPPOSED, FDA GYLON LIP, FLUORO GSKT
	24125	FDA GYLON	FDA GYLON LIP, FLUORO GSKT
	24128	FDA GYLON	DBL TANDEM, FDA GYLON LIP, FLUORO GSKT
62	21702	PTFE	STD
63	21158	MILL-RIGHT N	STD
	21168	SILICONE	STD
	21290	MILL-RIGHT ES	STD
	21695	MILL-RIGHT V	STD
63F1	23078	MILL-RIGHT N	FELT
63G1	23500	MILL-RIGHT N	GYLON EXCLUDER LIP
	23501	MILL-RIGHT ES	GYLON EXCLUDER LIP
	23502	MILL-RIGHT V	GYLON EXCLUDER LIP

Model	Prefix	Seal Material	Description
63R1	23052	MILL-RIGHT ES	DUAL OPPOSED LIP - SINGLE SPRING
	23547	MILL-RIGHT N	DUAL OPPOSED LIP - SINGLE SPRING
	23711	MILL-RIGHT V	DUAL OPPOSED LIP - SINGLE SPRING
63R2	23548	MILL-RIGHT N	DUAL OPPOSED LIP - DUAL SPRING
	23627	MILL-RIGHT V	DUAL OPPOSED LIP - DUAL SPRING
	23769	MILL-RIGHT ES	DUAL OPPOSED LIP - DUAL SPRING
63T2	23550	MILL-RIGHT N	DUAL TANDEM LIP - DUAL SPRING
	23551	MILL-RIGHT ES	DUAL TANDEM LIP - DUAL SPRING
	23552	MILL-RIGHT V	DUAL TANDEM LIP - DUAL SPRING
63TB	23549	MILL-RIGHT N	DUAL TANDEM LIP - SINGLE SPRING
64	21238	MILL-RIGHT N	STD
	21243	SILICONE	STD
	21247	MILL-RIGHT ES	STD
	21852	MILL-RIGHT V	STD
64G1	22503	MILL-RIGHT N	GYLON EXCLUDER LIP
	22504	MILL-RIGHT ES	GYLON EXCLUDER LIP
	22505	MILL-RIGHT V	GYLON EXCLUDER LIP
71	26001	NITRILE	BONDED
76	26193	NITRILE	BONDED
87	26080	MILL-RIGHT N	STD, W/ RUBBER BUTTONS
	26081	MILL-RIGHT ES	STD, W/ RUBBER BUTTONS
	26097	MILL-RIGHT V	STD, W/ RUBBER BUTTONS
88	26088	MILL-RIGHT N	STD, W/ RUBBER BUTTONS
	26086	MILL-RIGHT ES	STD, W/ RUBBER BUTTONS
	26588	MILL-RIGHT V	STD, W/ RUBBER BUTTONS
88NS	26186	MILL-RIGHT ES	NO SPRING
	26188	MILL-RIGHT N	NO SPRING
91	27023	NITRILE	BONDED
92	27063	NITRILE	BONDED
94	27223	NITRILE	BONDED
	27685	FLUOROELASTOMER	BONDED
111	21011	MILL-RIGHT N	EXTERNAL
113	21012	MILL-RIGHT N	EXTERNAL
123	21016	MILL-RIGHT N	EXTERNAL
143	21332	NITRILE	CUSTOM SPLIT FACE SEAL WITH HOSE CLAMP
143A1	21339	MILL-RIGHT	MODEL 143A1 FACE SEAL WITH HOSE CLAMP
	21340	NITRILE	MODEL 143A1 FACE SEAL WITH HOSE CLAMP
	21341	FLUOROELASTOMER	MODEL 143A1 FACE SEAL WITH HOSE CLAMP

Model	Prefix	Seal Material	Description
143A2	21333	NITRILE	MODEL 143A2 FACE SEAL WITH HOSE CLAMP
	21334	MILL-RIGHT	MODEL 143A2 FACE SEAL WITH HOSE CLAMP
	21335	FLUROELASTOMER	MODEL 143A2 FACE SEAL WITH HOSE CLAMP
144W1	21342	MILL-RIGHT N	MODEL 144W1 SPLIT FACE SEAL
144W2	21343	MILL-RIGHT N	MODEL 144W2 SPLIT FACE SEAL
145A	21758	NITRILE	STD
	21761	FLUROELASTOMER	STD
145A1	21700	NITRILE	STD
	21712	MILL-RIGHT	STD
	21722	FLUROELASTOMER	STD
145A2	21750	NITRILE	STD
	21751	FLUROELASTOMER	STD
	21754	MILL-RIGHT	STD
145L	21738	FLUROELASTOMER	STD
	21748	NITRILE	STD
145S	21749	NITRILE	STD
151	25600	NITRILE	SOLID GENERAL PURPOSE COMPOSITE SEAL
	25601	HYDROGENATED NITRILE	SOLID GENERAL PURPOSE COMPOSITE SEAL
	25602	FLUROELASTOMER	SOLID GENERAL PURPOSE COMPOSITE SEAL
	25810	NITRILE	SPLIT GENERAL PURPOSE COMPOSITE SEAL
	25603	HYDROGENATED NITRILE	SPLIT GENERAL PURPOSE COMPOSITE SEAL
	25410	FLUROELASTOMER	SPLIT GENERAL PURPOSE COMPOSITE SEAL
154	25812	NITRILE	SOLID GENERAL PURPOSE COMPOSITE SEAL
	25829	HYDROGENATED NITRILE	SOLID GENERAL PURPOSE COMPOSITE SEAL
	25814	FLUROELASTOMER	SOLID GENERAL PURPOSE COMPOSITE SEAL
	25813	NITRILE	SPLIT GENERAL PURPOSE COMPOSITE SEAL
	25827	HYDROGENATED NITRILE	SPLIT GENERAL PURPOSE COMPOSITE SEAL
	25828	FLUROELASTOMER	SPLIT GENERAL PURPOSE COMPOSITE SEAL
154M	25842	NITRILE	SOLID GENERAL PURPOSE COMPOSITE SEAL
	25843	HYDROGENATED NITRILE	SOLID GENERAL PURPOSE COMPOSITE SEAL
	25844	FLUROELASTOMER	SOLID GENERAL PURPOSE COMPOSITE SEAL
154R1	25856	NITRILE	SOLID GENERAL PURPOSE COMPOSITE SEAL W/DUST LIP
	25861	HYDROGENATED NITRILE	SOLID GENERAL PURPOSE COMPOSITE SEAL W/DUST LIP
	25866	FLUROELASTOMER	SOLID GENERAL PURPOSE COMPOSITE SEAL W/DUST LIP
	25872	NITRILE	SOLID GENERAL PURPOSE COMPOSITE SEAL W/DUST LIP
	25876	HYDROGENATED NITRILE	SOLID GENERAL PURPOSE COMPOSITE SEAL W/DUST LIP
	25881	FLUROELASTOMER	SOLID GENERAL PURPOSE COMPOSITE SEAL W/DUST LIP

GYLON, MILL-RIGHT, P/S, GUARDIAN AND MICRO-TEC are registered trademarks of Garlock Sealing Technologies LLC. Please visit www.klozure.com for technical information

NOTE: Please see appendix B for obsolete model number to part number conversion.

Model	Prefix	Description
EQUALIZER®	24801	NO FLANGE
	24802	FLANGED DESIGN
	24807	SMALL CROSS-SECTION DESIGN
GUARDIAN™	29602	FLANGED DESIGN
	29604	FLANGED DESIGN - 316SS
	29606	SMALL CROSS SECTION - 316SS
	29607	SMALL CROSS SECTION
	29608	SMALL CROSS SECTION
	29609	NO FLANGE - .375" WIDTH
	29610	SMALL FLANGE O.D.
	29611	NO FLANGE - .375" WIDTH - 316SS
	29612	NO FLANGE - 316SS
	29616	SPLIT PILLOW BLOCK
	29617	SPLIT PILLOW BLOCK - 316SS
	29619	NO FLANGE
	29620	VERTICAL, FLANGED DESIGN
	29621	VERTICAL, SMALL CROSS SECTION DESIGN
29622	VERTICAL - 316SS	
29623	VERTICAL, SMALL CROSS SECTION DESIGN - 316SS	
SPLIT GUARDIAN™	29702	FLANGED DESIGN
	29716	SPLIT PILLOW BLOCK
MICRO-TEC® II	29102	FLANGED DESIGN
	29106	FLANGED DESIGN - 316SS
	29107	SMALL CROSS SECTION
	29112	NO FLANGE - 316SS
	29116	SPLIT PILLOW BLOCK
	29117	SPLIT PILLOW BLOCK - 316SS
	29119	NO FLANGE
	29120	VERTICAL
	29121	VERTICAL, SMALL CROSS SECTION DESIGN
	29122	VERTICAL - 316SS
	29123	VERTICAL, SMALL CROSS SECTION DESIGN - 316SS
ISO-GARD®	29500	FLANGED DESIGN - TWO O-RINGS on O.D.
	29502	FLANGED DESIGN
	29507	SMALL CROSS SECTION
	29516	SPLIT PILLOW BLOCK
	29518	GREASE PURGE
	29519	NO FLANGE
	29520	VERTICAL - ONE O-RING ON O.D.
	29521	VERTICAL - TWO O-RINGS ON O.D.

GYLON, MILL-RIGHT, P/S, GUARDIAN AND MICRO-TEC are registered trademarks of Garlock Sealing Technologies LLC. Please visit www.klazure.com for technical information

NOTE: Please see appendix B for obsolete model number to part number conversion.

Prefix	Model	Seal Material	DESCRIPTION
21003	58	THERMO-CERAM	STANDARD CONFIGURATION
21005	58	THERMO-CERAM	316 SS CASE
21011	111	MILL-RIGHT N	EXTERNAL
21012	113	MILL-RIGHT N	EXTERNAL
21016	123	MILL-RIGHT N	EXTERNAL
21020	50	MILL-RIGHT N	GARTER SPRING
21022	51	MILL-RIGHT N	CARBON STEEL CASE W/ METAL BUTTONS
21086	53	MILL-RIGHT N	STANDARD CONFIGURATION
21095	53	SILICONE	STANDARD CONFIGURATION
21096	53	MILL-RIGHT ES	STANDARD CONFIGURATION
21140	54	MILL-RIGHT N	STANDARD CONFIGURATION
21158	63	MILL-RIGHT N	STANDARD CONFIGURATION
21168	63	SILICONE	STANDARD CONFIGURATION
21238	64	MILL-RIGHT N	STANDARD CONFIGURATION
21243	64	SILICONE	STANDARD CONFIGURATION
21247	64	MILL-RIGHT ES	STANDARD CONFIGURATION
21290	63	MILL-RIGHT ES	STANDARD CONFIGURATION
21332	143	NITRILE	MODEL 142 ELEMENT, FACE SEAL WITH HOSE CLAMP
21333	143	NITRILE	MODEL 145A2 ELEMENT, FACE SEAL WITH HOSE CLAMP
21334	143	MILL-RIGHT ES	MODEL 145A2 ELEMENT, FACE SEAL WITH HOSE CLAMP
21335	143	MILL-RIGHT V	MODEL 145A2 ELEMENT, FACE SEAL WITH HOSE CLAMP
21339	143	MILL-RIGHT ES	MODEL 145A1 ELEMENT, FACE SEAL WITH HOSE CLAMP
21340	143	NITRILE	MODEL 145A1 ELEMENT, FACE SEAL WITH HOSE CLAMP
21342	144W1	MILL-RIGHT N	MODEL 144W1 SPLIT FACE SEAL
21343	144W2	MILL-RIGHT N	MODEL 144W2 SPLIT FACE SEAL
21486	51	MILL-RIGHT N	BRASS CASE WITH BRASS BUTTONS
21619	51	MILL-RIGHT N	BRASS CASE, NO BUTTONS
21695	63	MILL-RIGHT V	STANDARD CONFIGURATION
21699	53	MILL-RIGHT V	STANDARD CONFIGURATION
21700	145A1	NITRILE	STANDARD CONFIGURATION
21702	62	PTFE	STANDARD CONFIGURATION
21712	145A1	MILL-RIGHT ES	STANDARD CONFIGURATION
21722	145A1	MILL-RIGHT V	STANDARD CONFIGURATION
21738	145L	FLUROELASTOMER	STANDARD CONFIGURATION
21748	145L	NITRILE	STANDARD CONFIGURATION
21749	145S	NITRILE	STANDARD CONFIGURATION
21750	145A2	NITRILE	STANDARD CONFIGURATION
21751	145A2	MILL-RIGHT V	STANDARD CONFIGURATION
21754	145A2	MILL-RIGHT ES	STANDARD CONFIGURATION
21758	145A	MILL-RIGHT N	STANDARD CONFIGURATION
21761	145A	FLUROELASTOMER	STANDARD CONFIGURATION
21852	64	MILL-RIGHT V	STANDARD CONFIGURATION
22503	64G1	MILL-RIGHT N	GYLON EXCLUDER LIP
22504	64G1	MILL-RIGHT ES	GYLON EXCLUDER LIP
22505	64G1	MILL-RIGHT V	GYLON EXCLUDER LIP
22537	53R1	MILL-RIGHT N	STANDARD CONFIGURATION
22543	53R1	MILL-RIGHT V	STANDARD CONFIGURATION

Prefix	Model	Seal Material	DESCRIPTION
22544	53R1	MILL-RIGHT ES	STANDARD CONFIGURATION
22627	53R2	MILL-RIGHT N	STANDARD CONFIGURATION
22634	53R2	MILL-RIGHT ES	STANDARD CONFIGURATION
22897	53T2	MILL-RIGHT N	STANDARD CONFIGURATION
22903	53T2	MILL-RIGHT V	STANDARD CONFIGURATION
22987	53F1	MILL-RIGHT N	STANDARD CONFIGURATION
23052	63R1	MILL-RIGHT ES	DUAL OPPOSED LIP - SINGLE SPRING
23078	63F1	MILL-RIGHT N	FELT
23500	63G1	MILL-RIGHT N	GYLON EXCLUDER LIP
23501	63G1	MILL-RIGHT ES	GYLON EXCLUDER LIP
23502	63G1	MILL-RIGHT V	GYLON EXCLUDER LIP
23503	63G1	MILL-RIGHT V	GYLON EXCLUDER LIP
23547	63R1	MILL-RIGHT N	DUAL OPPOSED LIP - SINGLE SPRING
23548	63R2	MILL-RIGHT N	DUAL OPPOSED LIP - DUAL SPRING
23549	63TB	MILL-RIGHT N	DUAL TANDEM LIP - SINGLE SPRING
23550	63T2	MILL-RIGHT N	DUAL TANDEM LIP - DUAL SPRING
23552	63T2	MILL-RIGHT V	DUAL TANDEM LIP - DUAL SPRING
23627	63R2	MILL-RIGHT V	DUAL OPPOSED LIP - DUAL SPRING
23708	53R2	MILL-RIGHT V	STANDARD CONFIGURATION
23769	63R2	MILL-RIGHT ES	DUAL OPPOSED LIP - DUAL SPRING
24056	PS I (61)	FDA GYLON	REVERSE LIP - FDA
24060	PS I (61)	GYLON	GYLON LIP , FLUORO GASKET
24062	PS I (61)	GYLON	DOUBLE TANDEM, GYLON LIP, FLUORO GASKET
24063	PS I (61)	GYLON	DOUBLE OPPOSED, GYLON LIP, FLUORO GASKET
24064	PS I (61)	GYLON	GYLON LIP, REVERSE LIP, FLUORO GASKET
24076	PS I (61)	FDA GYLON	DOUBLE OPPOSED, GYLON LIP - FDA
24125	PS I (61)	FDA GYLON	GYLON LIP - FDA
24128	PS I (61)	FDA GYLON	DOUBLE TANDEM, GYLON LIP - FDA
24600	26	MILL-RIGHT N	SOLID
24602	26	MILL-RIGHT V	SOLID
24606	26R1	MILL-RIGHT V	SPLIT , DUAL LIP
24608	26R1	MILL-RIGHT N	SPLIT, DUAL LIP
24610	26	MILL-RIGHT N	SPLIT
24612	26	MILL-RIGHT V	SPLIT
24620	26R1	MILL-RIGHT N	DUAL LIP, SOLID
24622	26R1	MILL-RIGHT V	DUAL LIP, SOLID
24626	26	MILL-RIGHT ES	SOLID
24627	26	MILL-RIGHT ES	SPLIT
24629	26R1	MILL-RIGHT ES	DUAL LIP, SOLID
24648	26R1	MILL-RIGHT ES	SPLIT, DUAL LIP
24650	26NS	MILL-RIGHT N	NO SPRING
24652	26NS	MILL-RIGHT V	NO SPRING
24656	26HR	MILL-RIGHT ES	HIGH RUNOUT, SPLIT
24660	26HR	MILL-RIGHT N	HIGH RUNOUT, SOLID
24662	26HR	MILL-RIGHT V	HIGH RUNOUT, SOLID
24663	26HR	MILL-RIGHT N	HIGH RUNOUT, SPLIT
24664	26HR	MILL-RIGHT ES	HIGH RUNOUT, SOLID
24700	59	MILL-RIGHT N	STANDARD CONFIGURATION

Prefix	Model	Seal Material	DESCRIPTION
24702	59	MILL-RIGHT V	STANDARD CONFIGURATION
24715	59	MILL-RIGHT ES	STANDARD CONFIGURATION
24750	59G1	MILL-RIGHT N	GYLON EXCLUDER LIP
24751	59G1	MILL-RIGHT ES	GYLON EXCLUDER LIP
24752	59G1	MILL-RIGHT V	GYLON EXCLUDER LIP
25001	21	MILL-RIGHT N	SPLIT
25002	21	SILICONE	SPLIT
25003	23	MILL-RIGHT N	SPLIT
25004	23	SILICONE	SPLIT
25005	24	MILL-RIGHT N	SPLIT
25006	23	MILL-RIGHT V	SPLIT
25008	21	MILL-RIGHT V	SPLIT
25010	23	MILL-RIGHT ES	SPLIT
25018	21	MILL-RIGHT ES	SPLIT
25029	24	MILL-RIGHT ES	SPLIT
25030	24	MILL-RIGHT V	SPLIT
25056	25	PTFE	SOLID
25058	25	PTFE	SPLIT
25600	151	NITRILE	SOLID GENERAL PURPOSE COMPOSITE SEAL
25601	151	HYDROGENATED NITRILE	SOLID GENERAL PURPOSE COMPOSITE SEAL
25602	151	FLUROELASTOMER	SOLID GENERAL PURPOSE COMPOSITE SEAL
25810	151	NITRILE	SPLIT GENERAL PURPOSE COMPOSITE SEAL
25603	151	HYDROGENATED NITRILE	SPLIT GENERAL PURPOSE COMPOSITE SEAL
25410	151	FLUROELASTOMER	SPLIT GENERAL PURPOSE COMPOSITE SEAL
25812	154	NITRILE	SOLID GENERAL PURPOSE COMPOSITE SEAL
25829	154	HYDROGENATED NITRILE	SOLID GENERAL PURPOSE COMPOSITE SEAL
25814	154	FLUROELASTOMER	SOLID GENERAL PURPOSE COMPOSITE SEAL
25813	154	NITRILE	SPLIT GENERAL PURPOSE COMPOSITE SEAL
25827	154	HYDROGENATED NITRILE	SPLIT GENERAL PURPOSE COMPOSITE SEAL
25828	154	FLUROELASTOMER	SPLIT GENERAL PURPOSE COMPOSITE SEAL
25842	154M	NITRILE	SOLID GENERAL PURPOSE COMPOSITE SEAL
25843	154M	HYDROGENATED NITRILE	SOLID GENERAL PURPOSE COMPOSITE SEAL
25844	154M	FLUROELASTOMER	SOLID GENERAL PURPOSE COMPOSITE SEAL
25856	154R1	NITRILE	SOLID GENERAL PURPOSE COMPOSITE SEAL W/DUST LIP
25961	154R1	HYDROGENATED NITRILE	SOLID GENERAL PURPOSE COMPOSITE SEAL W/DUST LIP
25866	154R1	FLUROELASTOMER	SOLID GENERAL PURPOSE COMPOSITE SEAL W/DUST LIP
25872	154R1	NITRILE	SOLID GENERAL PURPOSE COMPOSITE SEAL W/DUST LIP
25876	154R1	HYDROGENATED NITRILE	SOLID GENERAL PURPOSE COMPOSITE SEAL W/DUST LIP
25881	154R1	FLUROELASTOMER	SOLID GENERAL PURPOSE COMPOSITE SEAL W/DUST LIP
26001	71	NITRILE	BONDED
26056	57	MILL-RIGHT N	STANDARD CONFIGURATION
26057	57	MILL-RIGHT V	STANDARD CONFIGURATION
26058	57	MILL-RIGHT ES	STANDARD CONFIGURATION
26080	87	MILL-RIGHT N	STANDARD CONFIGURATION
26081	87	MILL-RIGHT ES	STANDARD CONFIGURATION
26088	88	MILL-RIGHT N	STANDARD CONFIGURATION
26097	87	MILL-RIGHT V	STANDARD CONFIGURATION

Prefix	Model	Seal Material	DESCRIPTION
26186	88NS	MILL-RIGHT ES	NO SPRING
26188	88NS	MILL-RIGHT N	NO SPRING
26193	76	NITRILE	BONDED
26588	88	MILL-RIGHT V	STANDARD CONFIGURATION
27023	91	NITRILE	BONDED
27063	92	NITRILE	BONDED
27223	94	NITRILE	BONDED
27685	94	FLUOROELASTOMER	BONDED

GYLON, MILL-RIGHT, P/S, GUARDIAN AND MICRO-TEC are registered trademarks of Garlock Sealing Technologies LLC. Please visit www.klozure.com for technical information

NOTE: Please see appendix B for obsolete model number to part number conversion.

OBSOLETE MODEL NUMBER TO PART NUMBER CONVERSION

OBSOLETE MODEL NUMBER TO PART NUMBER CONVERSION

Model	Prefix	Seal Material	DESCRIPTION
21	25051	MILL-RIGHT N	2 BUTT CUTS @ 180 DEG APART
	25068	SILICONE	2 BUTT CUTS @ 180 DEG APART
	25089	MILL-RIGHT N	RIGHT HAND BEVEL CUT
	25254	MILL-RIGHT N	1/8" THK GASKETS
	25255	MILL-RIGHT N	3/16" THK GASKETS
23	25019	MILL-RIGHT ES	GREEN O.D. SEALANT
	25020	MILL-RIGHT ES	SOLID, GREEN O.D. SEALANT
	25025	MILL-RIGHT N	316 STAINLESS STEEL SPRING-SPLIT
	25036	MILL-RIGHT N	ISO TOLERANCE STANDARDS
	25044	MILL-RIGHT V	LEFT HAND BEVEL CUT
	25075	MILL-RIGHT N	2 BUTT CUTS, 1/3 & 2/3 SECTIONS
	25077	MILL-RIGHT N	SOLID, SPECIAL
	25080	SILICONE	2 BUTT CUTS @ 180 DEG APART
	25084	SILICONE	SOLID
	25086	MILL-RIGHT N	NOTCHES
	25090	SILICONE	RIGHT HAND CUT
	25109	MILL-RIGHT N	EXTERNAL CONSTRUCTION
	25114	BUTYL	SPLIT
	25131	MILL-RIGHT N	2 BUTT CUTS, 3/16" GASKET
	25152	MILL-RIGHT N	SPECIAL
	25153	SILICONE	SOLID, W/ GARTER SPRING
	25156	MILL-RIGHT N	SOLID, SPECIAL
	25157	SILICONE	SEMI-FINISHED, UNCUT
	25168	MILL-RIGHT ES	NOTCHES
	25204	MILL-RIGHT N	1/8" THK GASKETS
	25205	MILL-RIGHT N	3/16" THK GASKETS
	25206	MILL-RIGHT N	1/4" THK GASKETS
	25229	SILICONE	ENCAP SPRING
	25230	SILICONE	1/8" THK GASKETS
	25270	MILL-RIGHT V	ENCAP SPRING
	25278	MILL-RIGHT N	ENCAP SPRING, SPECIAL
	25279	MILL-RIGHT N	2 LEFT HAND BEVEL CUTS, CUT 1/3 & 2/3 SECT
	25280	MILL-RIGHT N	RIGHT HAND BEVEL CUTS, CUT 1/3 & 2/3 SECT.
25281	MILL-RIGHT N	SOLID, SPECIAL	
25284	FDA SILICONE	ENCAP SPRING, FDA	
25285	FDA SILICONE	ENCAP SPRING, FDA - SOLID	
25305	MILL-RIGHT V	NO SPRING	
25	25074	PTFE	302 STAINLESS STEEL SPRING SOLID

OBSOLETE MODEL NUMBER TO PART NUMBER CONVERSION

OBSOLETE MODEL NUMBER TO PART NUMBER CONVERSION

Model	Prefix	Seal Material	Description
26	24615	MILL-RIGHT N	LOW TEMP. MILL-RIGHT N
	24617	MILL-RIGHT V	SPLIT, NO SPRING
	24623	MILL-RIGHT V	SOLID, NO FABRIC
	24624	MILL-RIGHT N	SPLIT, NO FABRIC
	24646	MILL-RIGHT V	SPLIT, NO FABRIC
	24653	MILL-RIGHT N	NO FABRIC IN HEEL
	24677	MILL-RIGHT ES	SOLID, NO FABRIC
	24682	MILL-RIGHT V	HIGH PRESSURE
	24698	MILL-RIGHT N	SPLIT TO ISO TOLERANCE STD
26E	24640	MILL-RIGHT N	EXTERNAL
26HP	24680	MILL-RIGHT N	HIGH PRESSURE
51	21021	MILL-RIGHT N	NO SPRING
53	21060	MILL-RIGHT N	ISO TOLERANCE STD
	21082	MILL-RIGHT ES	NO OD SEALANT, STAMP MILL-RIGHT ES
	21083	MILL-RIGHT ES	METAL BUTTONS, ISO STD
	21084	MILL-RIGHT ES	ISO TOLERANCE STD
	21092	MILL-RIGHT N	
	21094	MILL-RIGHT ES	
	21097	MILL-RIGHT ES	
	21099	MILL-RIGHT ES	GREEN O.D. SEALANT
	21100	SILICONE	
	21101	FDA SILICONE	FDA SILICONE
	21366	MILL-RIGHT N	LOW TEMP NTRILE
	21381	BUTYL	
	21392	BUTYL	
	21446	SILICONE	
	21657	MILL-RIGHT N	O.D. SEALANT
	21682	MILL-RIGHT V	GREEN MILL-RIGHT V
	21692	MILL-RIGHT V	O.D. SEALANT
	21706	MILL-RIGHT N	DRAW HOLES
	21733	MILL-RIGHT V	NO SPRING
21836	MILL-RIGHT N	LOW TEMP	
21882	MILL-RIGHT V		
53F1	22992	MILL-RIGHT N	
	22995	MILL-RIGHT ES	
	22996	MILL-RIGHT V	
	22998	SILICONE	
53R2	22628	MILL-RIGHT N	
	22629	FDA SILICONE	
	23703	SILICONE	
53T2	22898	MILL-RIGHT N	
	22899	FDA SILICONE	
	22905	MILL-RIGHT ES	
	23051	SILICONE	

O B S O L E T E M O D E L N U M B E R T O P A R T N U M B E R C O N V E R S I O N

O B S O L E T E M O D E L N U M B E R T O P A R T N U M B E R C O N V E R S I O N

Model	Prefix	Seal Material	Description
53TB	22807	MILL-RIGHT N	
54	21883	MILL-RIGHT N	
57	26059	SILICONE (SIL)	
	26061	SILICONE (SIL)	MODIFIED DUST LIP
58	21008	CERAMIC	
	21009	CARBON FLMNT	
59	24705	MILL-RIGHT V	
	24710	MILL-RIGHT N	SPECIAL
	24711	MILL-RIGHT N	
	24718	MILL-RIGHT ES	STAMP "MILL-RIGHT ES" ON CASE
	24719	MILL-RIGHT N	NO SPRING METAL BUTTONS
	24735	MILL-RIGHT ES	SPECIAL EXCLUDER LIP
	24737	MILL-RIGHT ES	NO SPRING
	24738	MILL-RIGHT ES	BLUE COATING ON INNER SHELL
	24740	MILL-RIGHT V	ELEMENT ONLY-SPLIT
	24741	MILL-RIGHT V	ELEMENT ONLY-SPLIT-NO SPRING
	24744	MILL-RIGHT N	5/16" METAL BUTTONS
	24755	MILL-RIGHT N	SPECIAL WIDTH TOLERANCE TO BE +/- .008"
	24757	MILL-RIGHT V	
	24769	MILL-RIGHT ES	.156" METAL BUTTONS
24772	MILL-RIGHT ES	.197" (5mm) METAL BUTTONS	
24773	MILL-RIGHT N		
59G1	24734	MILL-RIGHT V	GYLON EXCLUDER LIP
	24753	MILL-RIGHT ES	GYLON ENHANCED, METAL BUTTONS
59R1	24720	MILL-RIGHT N	
	24726	MILL-RIGHT N	
61 P/S® I	24057	PTFE	PTFE LIP , MILL-RIGHT N GSKT
	24059	FDA GYLON	DBL TANDEM, FDA WHITE GYLON LIP, FDA WHITE GYLON GSKT
	24061	FDA GYLON	FDA WHITE GYLON LIP, FLUORO GSKT
	24070	GYLON	REDUCED LOAD , BLACK GYLON LIP , FLUORO GSKT
	24072	FDA GYLON	DBL OPPOSED, FDA WHITE GYLON LIP , FDA FLUORO GSKT
	24073	FDA GYLON	FDA WHITE GYLON LIP ONLY
	24105	GYLON	FLUORO LIP ONLY
	24108	PTFE	PTFE LIP, FLUORO GSKT, 304SS INNER CASE
	24130	FDA GYLON	REVERSED LIP, FDA WHITE GYLON LIP, FDA FLUORO GSKT
62	21154	PTFE	WHITE PTFE, STAINLESS STEEL SPRING
	21155	PTFE	WHITE PTFE
	21653	PTFE	WHITE PTFE, STAINLESS STEEL SPRING
	21777	PTFE	STAINLESS STEEL SPRING
	21844	PTFE	STAINLESS STEEL SPRING
	21867	PTFE	NO SPRING
	21954	PTFE	NO SPRING

OBSOLETE MODEL NUMBER TO PART NUMBER CONVERSION

OBSOLETE MODEL NUMBER TO PART NUMBER CONVERSION

Model	Prefix	Seal Material	Description
63	21162	MILL-RIGHT N	
	21172	FDA SILICONE	FDA APPROVED SILICONE
	21175	FDA SILICONE	FDA APPROVED SILICONE
	21186	SILICONE	
	21295	MILL-RIGHT ES	
	21296	MILL-RIGHT ES	
	21374	BUTYL	
	21466	MILL-RIGHT N	SPECIAL
	21474	SILICONE	NO SPRING
	21480	SILICONE	
	21688	MILL-RIGHT N	DRAW HOLES
	21690	MILL-RIGHT V	GREEN MILL-RIGHT V
	21707	MILL-RIGHT N	DRAW HOLES
	21760	MILL-RIGHT N	DRAW HOLES, O.D. SEALANT
	21890	MILL-RIGHT N	
21933	SILICONE	O.D. SEALANT	
63F1	23670	MILL-RIGHT N	
63R	23169	MILL-RIGHT V	NO SPRING
63R1	23605	MILL-RIGHT N	
63R2	23046	MILL-RIGHT N	
	23631	MILL-RIGHT V	
	23689	MILL-RIGHT N	
	23747	MILL-RIGHT N	SPECIAL
63T2	23713	FDA SILICONE	FDA SILICONE
	23748	MILL-RIGHT V	
63TB	23690	MILL-RIGHT N	
64	21223	MILL-RIGHT N	5/16" METAL BUTTONS
	21241	MILL-RIGHT ES	BLUE COATING ON INNER RING
	21246	MILL-RIGHT N	STAINLESS STEEL SPRING
	21254	MILL-RIGHT N	METAL BUTTONS
	21255	MILL-RIGHT ES	STAMP "MILL-RIGHT ES" ON CASE
	21256	MILL-RIGHT N	NO SPRINGS
	21261	MILL-RIGHT N	STAINLESS STEEL GARTER SPRING
	21385	SILICONE	NO SPRING
	21398	MILL-RIGHT V	ZINC PLATED FILLER RING
	21855	MILL-RIGHT V	METAL BUTTONS
	21859	MILL-RIGHT V	
	21886	SILICONE	METAL BUTTONS
	21997	SILICONE	

Oil Seals

OBSOLETE OIL SEALS — APPENDIX B

OBSOLETE MODEL NUMBER TO PART NUMBER CONVERSION

Model	Prefix	Seal Material	Description
66	21519	MILL-RIGHT V	STAINLESS STEEL SPRING
	21913	MILL-RIGHT N	STAINLESS STEEL SPRING
	21930	MILL-RIGHT N	STAINLESS STEEL SPRING
67	21632	MILL-RIGHT N	STAINLESS STEEL SPRING
	21664	MILL-RIGHT N	O.D. SEALANT
	21694	MILL-RIGHT N	NO SPRING
	21763	SILICONE	STAINLESS STEEL SPRING
	21800	MILL-RIGHT N	STAINLESS STEEL SPRING
	21801	MILL-RIGHT N	NO SPRING
	21818	MILL-RIGHT ES	
	21819	MILL-RIGHT ES	STAINLESS STEEL SPRING
	21827	MILL-RIGHT ES	
21944	MILL-RIGHT N		
67R1	23048	MILL-RIGHT N	
67T2	23621	MILL-RIGHT N	
68	21910	MILL-RIGHT N	STAINLESS STEEL SPRING
68R2	23724	MILL-RIGHT N	STAINLESS STEEL SPRING
	23727	MILL-RIGHT N	
	23736	MILL-RIGHT N	STAINLESS STEEL SPRING; 9010 FILLER RING
87	26078	MILL-RIGHT ES	NO BUTTONS, .093" THK METAL INSERT
88	26079	MILL-RIGHT N	STAINLESS STEEL SPRING
	26185	MILL-RIGHT ES	NO BUTTONS
88NS	26589	MILL-RIGHT V	NO SPRING
113	21503	MILL-RIGHT N	
	21927	MILL-RIGHT N	
123	21814	MILL-RIGHT ES	
142	21485	MILL-RIGHT	MOLDED LIP ONLY, BUTT JOINT
145A2	21757	BUTYL	

OBSOLETE MODEL NUMBER TO PART NUMBER CONVERSION

COMPOUND COMPATIBILITY CHART — APPENDIX C

Compound Code	MILL-RIGHT® N NBR			MILL-RIGHT® ES HNBR			MILL-RIGHT® V FKM			Silicone VMQ			GYLON® PTFE		
	Rating	°F	°C	Rating	°F	°C	Rating	°F	°C	Rating	°F	°C	Rating	°F	°C
Acetamide (Acryimide)	1	70	21	1	70	21	2	140	60	3	70	21	1	300	149
Acetone	4	70	21	4	70	21	4	70	21	3	70	21	1	200	93
Acetyl Chloride	4	70	21	4	70	21	2	70	21	3	70	21	1	200	93
Acetylene Gas	1	200	93	1	ND	ND	1	200	93	2	70	21	1	200	93
Aluminum Chloride	1	160	71	1	70	21	1	212	100	2	70	21	1	boiling	boiling
Aluminum Phosphate	1	70	21	1	70	21	1	70	21	1	70	21	1	70	21
Aluminum Sulphate	1	160	71	1	ND	ND	1	140	60	1	70	21	1	200	93
Ammonium Chloride	2	200	93	1	70	21	1	212	100	3	70	21	1	250	121
Ammonium Hydroxide	4	140	60	4	ND	ND	2	70	21	1	70	21	1	300	149
Ammonium Nitrate	1	200	93	1	70	21	1	176	80	3	70	21	1	200	93
Ammonium Nitrite	1	70	21	1	70	21	1	70	21	2	70	21	1	70	21
Ammonium Phosphate	1	200	93	1	ND	ND	1	176	80	1	70	21	1	70	21
Ammonium Sulfate	1	200	93	1	ND	ND	1	176	80	1	70	21	1	200	93
Amyl Borate	2	100	38	1	70	21	1	70	21	4	70	21	1	70	21
Amyl Chloronaphthalene	4	80	27	4	70	21	1	140	60	4	70	21	1	70	21
Amyl Naphthalene	4	70	21	4	70	21	1	70	21	4	70	21	1	70	21
Arsenic Acid	1	140	60	1	70	21	1	140	60	1	70	21	1	200	93
Asphalt Emulsion	2	70	21	ND	ND	ND	1	400	204	4	70	21	1	180	82
Asphalt Topping	2	150	66	2	ND	ND	1	212	100	4	70	21	1	180	82
ATF-TYPE A	1	70	21	1	70	21	1	70	21	1	70	21	1	450	232
Automotive Brake Fluid	3	70	21	ND	ND	ND	4	70	21	1	70	21	1	70	21
Automotive Gasoline	1	250	121	ND	ND	ND	1	70	21	4	70	21	ND	ND	ND
Benzine (Gasoline)	1	250	121	1	ND	ND	1	100	38	4	70	21	1	300	149
Benzoic Acid	4	70	21	3	ND	ND	1	176	80	4	70	21	1	300	149
Benzoyl Chloride	4	70	21	4	ND	ND	4	70	21	4	70	21	1	70	21
Benzyl Alcohol	4	70	21	4	ND	ND	1	140	60	2	ND	ND	1	400	204
Benzyl Benzoate	4	70	21	4	ND	ND	1	70	21	1	ND	ND	1	70	21
Benzyl Chloride	4	70	21	4	ND	ND	1	200	93	4	70	21	1	387	197
Biphenyl	4	70	21	4	70	21	1	300	149	4	70	21	1	300	149
Black Liquor	1	140	60	ND	ND	ND	1	212	100	1	70	21	1	70	21
Black Liquor Waste	1	70	21	ND	ND	ND	1	70	21	ND	ND	ND	1	70	21
Black Sulfate Liquor	2	200	93	ND	ND	ND	1	176	80	2	70	21	1	70	21
Blast Furnace Gas	4	70	21	4	70	21	1	70	21	1	250	121	1	70	21
Boric Acid	1	140	60	1	70	21	1	176	80	1	70	21	1	300	149
Bromine Anhydrous Gas	4	70	21	4	ND	ND	1	70	21	3	70	21	1	300	149
Bromobenzene	4	70	21	4	70	21	1	70	21	4	70	21	1	122	50
Butadien (Monomer)	4	140	60	4	ND	ND	2	250	121	4	70	21	1	300	149
Butane	1	200	93	1	70	21	1	176	80	4	70	21	1	300	149
Butyl Acetate	4	70	21	4	70	21	4	70	21	4	70	21	1	300	149
N-Butyl Benzoate	4	70	21	4	70	21	1	70	21	1	ND	ND	1	122	50
Butyl Carbitol	4	70	21	4	70	21	3	70	21	4	70	21	1	70	21
Butyl Oleate	4	70	21	4	70	21	3	70	21	2	70	21	1	70	21
Butyl Stearate	2	104	40	2	70	21	1	104	40	ND	ND	ND	1	70	21
Butylene	1	250	121	4	70	21	1	140	60	4	70	21	1	200	93
Calcium Bisulfate	1	70	21	ND	ND	ND	1	70	21	3	70	21	1	70	21
Calcium Bisulfide	1	70	21	ND	ND	ND	1	140	60	3	70	21	1	70	21

Rating Key: 1 = Excellent compatibility up to given temperature 3 = Limited compatibility up to given temperature ND = No Data
 2 = Good compatibility up to given temperature 4 = Poor compatibility up to given temperature

COMPOUND COMPATIBILITY CHART — APPENDIX C

Compound Code	MILL-RIGHT® N NBR			MILL-RIGHT® ES HNBR			MILL-RIGHT® V FKM			Silicone VMQ			GYLON® PTFE		
	Rating	°F	°C	Rating	°F	°C	Rating	°F	°C	Rating	°F	°C	Rating	°F	°C
Calcium Bisulfite	1	104	40	1	70	21	1	176	80	1	70	21	1	200	93
Calcium Hydroxide	1	140	60	1	70	21	1	212	100	1	70	21	1	122	50
Calcium Hypochlorite	3	70	21	2	70	21	1	70	21	2	70	21	1	300	149
Calcium Nitrate	1	176	80	1	70	21	1	212	100	2	70	21	1	200	93
Calcium Sulfide	1	140	60	1	70	21	1	212	100	2	70	21	1	300	149
Carbamate	3	70	21	3	ND	ND	1	70	21	1	ND	ND	1	70	21
Carbolic Acid	4	70	21	4	70	21	1	140	60	4	70	21	1	70	21
Carbon Dioxide	1	160	71	1	70	21	2	212	100	2	70	21	1	300	149
Carbon Monoxide	1	140	60	1	70	21	1	212	100	1	140	60	1	300	149
Carbon Tetrachloride	4	70	21	2	70	21	1	75	24	4	70	21	1	200	93
Chlorine Dioxide	4	70	21	4	70	21	1	70	21	3	70	21	1	70	21
Chlorobenzene	4	70	21	4	70	21	1	200	93	4	70	21	1	300	149
Chlorotoluene	4	70	21	4	70	21	1	200	93	4	70	21	1	387	197
Chrome Plating Solutions	4	70	21	4	70	21	1	70	21	2	70	21	1	70	21
Chromic Acid	4	70	21	4	70	21	1	70	21	2	70	21	2	248	120
Cobalt Chloride	1	70	21	1	70	21	1	70	21	2	70	21	ND	ND	ND
Copper Chloride	1	176	80	1	70	21	1	212	100	1	70	21	1	150	66
Copper Cyanide	1	boiling	boiling	1	70	21	1	boiling	boiling	1	70	21	1	300	149
Copper Plating Solution	1	140	60	ND	ND	ND	1	140	60	4	70	21	1	70	21
Copper Sulfate	1	176	80	1	70	21	1	140	60	1	70	21	1	200	93
Creosote	2	70	21	2	ND	ND	1	212	100	4	70	21	1	70	21
Cresylic Acid	4	70	21	1	70	21	1	158	70	4	70	21	1	200	93
Cumene	4	70	21	4	70	21	1	200	93	4	70	21	3	122	50
Cyclohexane	1	250	121	1	70	21	1	200	93	4	70	21	1	300	149
Cyclohexanol	1	70	21	1	70	21	1	104	40	4	70	21	1	200	93
Degreasing Fluid	4	70	21	ND	ND	ND	1	70	21	ND	ND	ND	1	70	21
Denatured Alcohol	1	70	21	1	70	21	1	70	21	1	212	100	1	70	21
Detergent Solutions	1	200	93	1	70	21	1	212	100	1	ND	ND	1	300	149
Developing Fluids	1	70	21	1	70	21	1	70	21	1	70	21	1	300	149
Dibromoethyl Benzene	4	70	21	4	70	21	1	70	21	4	70	21	ND	ND	ND
O-Dichlorobenzene	4	70	21	4	70	21	1	158	70	4	70	21	1	125	52
Diesel Oil	1	250	121	1	70	21	1	200	93	4	70	21	1	300	149
Diethylamine	3	140	60	3	70	21	4	140	60	2	70	21	1	300	149
Diethylbenzene	4	70	21	4	70	21	1	200	93	4	70	21	1	122	50
Diethylene Glycol	1	200	93	1	ND	ND	1	140	60	2	70	21	1	125	52
Diisooctyl Sebacate	3	70	21	4	70	21	2	70	21	3	70	21	ND	ND	ND
Diisopropyl Benzene	4	70	21	4	70	21	1	200	93	4	70	21	1	70	21
Dimethylether	1	70	21	1	70	21	1	70	21	1	70	21	1	70	21
Dimethylphthalate	4	70	21	4	70	21	1	70	21	2	70	21	1	392	200
Dipentene	2	200	93	2	70	21	1	70	21	4	70	21	1	70	21
Diphenyl	4	70	21	4	70	21	1	300	149	4	70	21	1	300	149
Diphenyl Oxides	4	70	21	4	70	21	1	140	60	3	70	21	1	70	21
Dry Cleaning Fluids	3	70	21	3	70	21	1	70	21	4	70	21	1	70	21
Ethane	1	140	60	1	70	21	1	140	60	4	70	21	1	70	21
Ethanol	1	140	60	1	70	21	4	104	40	1	70	21	1	392	200
Ethyl Alcohol	1	140	60	1	70	21	1	70	21	2	70	21	1	392	200

COMPOUND COMPATIBILITY CHART — APPENDIX C

Compound Code	MILL-RIGHT® N NBR			MILL-RIGHT® ES HNBR			MILL-RIGHT® V FKM			Silicone VMQ			GYLON® PTFE		
	Rating	°F	°C	Rating	°F	°C	Rating	°F	°C	Rating	°F	°C	Rating	°F	°C
Ethyl Chloride	1	140	60	1	70	21	1	140	60	4	70	21	1	125	52
Ethyl Formate	4	70	21	4	70	21	1	70	21	ND	ND	ND	1	70	21
Ethyl Oxalate	4	70	21	4	70	21	1	70	21	4	70	21	1	70	21
Ethyl Silicate	1	70	21	1	70	21	1	70	21	ND	ND	ND	1	70	21
Ethylene	1	200	93	1	70	21	1	70	21	4	70	21	1	70	21
Ethylene Chlorohydrin	4	70	21	4	70	21	1	70	21	3	70	21	1	300	149
Ethylene Diamine	1	80	27	1	70	21	4	70	21	1	70	21	1	242	117
Ethylene Dichloride	4	70	21	4	70	21	1	200	93	4	70	21	1	300	149
Ethylene Glycol	1	212	100	1	70	21	1	250	121	1	70	21	1	300	149
Ethylene Trichloride	4	70	21	4	70	21	1	70	21	4	70	21	1	70	21
Ferric Chloride	1	150	66	1	70	21	1	176	80	2	70	21	1	300	149
Ferric Nitrate	1	140	60	1	70	21	1	212	100	3	70	21	1	300	149
Ferric Sulfate	1	140	60	1	70	21	1	176	80	2	70	21	1	300	149
Formic Acid	4	70	21	2	140	60	3	140	60	3	70	21	1	boiling	boiling
Freon 12	1	250	121	1	70	21	2	75	24	4	70	21	1	70	21
Freon 22	4	70	21	4	70	21	4	70	21	4	70	21	1	300	149
Fuel Oil	1	250	121	1	70	21	1	200	93	4	70	21	1	300	149
Fumaric Acid	1	70	21	1	70	21	1	70	21	2	70	21	1	70	21
Fyrquel	4	70	21	4	70	21	1	212	100	1	70	21	1	70	21
Gear Oil Super	1	212	100	1	70	21	1	350	177	1	70	21	ND	ND	ND
Grease	1	100	38	1	70	21	1	140	60	4	70	21	1	70	21
Hydraulic Oil	1	250	121	1	70	21	1	70	21	3	70	21	1	70	21
Hydrobromic Acid	4	140	60	4	70	21	1	140	60	4	70	21	1	212	100
Hydrocyanic Acid	2	140	60	2	70	21	1	140	60	3	70	21	1	300	149
Hydrofluosilicic Acid	1	70	21	1	70	21	1	70	21	4	70	21	1	200	93
Hydrogen Gas	1	200	93	1	70	21	1	176	80	3	140	60	1	300	149
Hypoid Lubes	2	70	21	2	70	21	1	300	149	4	70	21	ND	ND	ND
Isobutyl Alcohol	2	80	27	2	70	21	1	75	24	1	70	21	1	200	93
Isooctane	1	250	121	1	70	21	1	70	21	4	70	21	1	300	149
Isopropyl Alcohol	1	70	21	2	70	21	1	170	77	1	70	21	1	300	149
Kerosene	1	250	121	1	70	21	1	158	70	4	70	21	1	300	149
Ketones	4	70	21	4	70	21	4	70	21	4	70	21	1	300	149
Lacquers	4	70	21	4	70	21	4	70	21	4	70	21	1	70	21
Lacquer Solvents	4	70	21	4	70	21	4	70	21	4	70	21	1	70	21
Lead Nitrate	1	120	49	1	70	21	1	212	100	2	70	21	1	125	52
Lead Sulfamate	2	140	60	2	70	21	1	140	60	2	70	21	1	125	52
Linseed Oil	1	200	93	1	70	21	1	250	121	1	70	21	1	300	149
Liquefied Petroleum-Gas	1	250	121	1	70	21	1	176	80	4	70	21	1	200	93
Lubricating Oils	1	70	21	1	70	21	1	158	70	4	70	21	1	300	149
Magnesium Chloride	1	176	80	1	70	21	1	176	80	1	70	21	1	300	149
Magnesium Hydroxide	1	140	60	2	70	21	1	212	100	1	70	21	1	300	149
Magnesium Sulfate	1	176	80	1	70	21	1	boiling	boiling	1	70	21	1	300	149
Maleic Acid	4	176	80	4	70	21	1	140	60	4	70	21	1	300	149
Malic Acid	1	70	21	1	70	21	1	70	21	2	70	21	1	300	149
Methane	1	250	121	1	70	21	2	176	80	4	70	21	1	300	149

Rating Key: 1 = Excellent compatibility up to given temperature
2 = Good compatibility up to given temperature

3 = Limited compatibility up to given temperature
4 = Poor compatibility up to given temperature

ND = No Data

COMPOUND COMPATIBILITY CHART — APPENDIX C

Compound Code	MILL-RIGHT® N NBR			MILL-RIGHT® ES HNBR			MILL-RIGHT® V FKM			Silicone VMQ			GYLON® PTFE		
	Rating	°F	°C	Rating	°F	°C	Rating	°F	°C	Rating	°F	°C	Rating	°F	°C
Methanol	1	70	21	1	70	21	4	75	24	1	70	21	1	300	149
Methyl Alcohol	1	70	21	1	70	21	4	75	24	1	70	21	1	300	149
Methyl Bromide	2	70	21	2	70	21	1	160	71	1	ND	ND	1	300	149
Methyl Ether	1	70	21	1	70	21	1	70	21	1	70	21	1	70	21
Methyl Oleate	4	70	21	4	70	21	1	70	21	ND	ND	ND	1	70	21
Mineral Oil	1	250	121	1	70	21	1	70	21	2	70	21	1	356	180
Naphtha	1	250	121	2	70	21	1	158	70	4	70	21	1	300	149
Naphthalene	4	70	21	4	70	21	1	176	80	4	70	21	1	424	218
Naphthalenic	2	70	21	2	70	21	1	160	71	4	70	21	1	70	21
Natural Gas	1	250	121	1	70	21	1	176	80	4	70	21	1	70	21
Nickel Chloride	1	176	80	1	70	21	1	212	100	1	70	21	1	300	149
Nitric Acid (Dilute)	4	70	21	4	70	21	1	158	70	2	70	21	1	248	120
Octachloroluene	4	70	21	4	70	21	1	70	21	4	70	21	1	70	21
Octadecane	1	70	21	4	70	21	1	70	21	4	70	21	1	70	21
N-Octane	2	70	21	2	70	21	1	70	21	4	70	21	1	300	149
Octyl Alcohol	2	100	38	2	70	21	2	70	21	2	70	21	1	70	21
Oleum Spirits	2	70	21	2	70	21	1	160	71	4	70	21	1	70	21
Oxalic Acid	2	140	60	2	70	21	1	140	60	2	70	21	1	200	93
Oxygen-Cold	2	100	38	4	70	21	1	70	21	1	70	21	1	70	21
Oxygen-Hot	4	250	121	4	70	21	2	400	204	2	70	21	1	400	204
Ozone	4	70	21	1	70	21	1	70	21	1	400	204	1	125	52
Paint Thinner, Duco	4	70	21	4	70	21	2	200	93	4	70	21	1	70	21
Palmitic Acid	1	160	71	1	70	21	1	70	21	4	70	21	1	300	149
Perchloric Acid	4	70	21	4	70	21	3	200	93	4	ND	ND	1	200	93
Perchloroethylene	2	70	21	2	70	21	1	212	100	4	70	21	1	250	121
Petroleum	1	250	121	1	70	21	1	250	121	4	70	21	1	250	121
Phenol	4	70	21	4	70	21	1	140	60	4	ND	ND	1	300	149
Phenyl Benzene	4	70	21	4	70	21	1	300	149	4	70	21	1	300	149
Phenyl Ethyl Ether	4	70	21	4	70	21	4	70	21	4	70	21	1	70	21
Phenyl Hydrazine	4	70	21	4	70	21	1	70	21	1	ND	ND	1	70	21
Phorone	4	70	21	4	70	21	4	70	21	4	70	21	1	70	21
Phosphate Ester	4	70	21	4	70	21	4	70	21	1	70	21	1	70	21
Phosphorus Trichloride	4	70	21	4	70	21	1	70	21		ND	ND	1	300	149
Pickling Solution	4	70	21	4	70	21	2	70	21	4	70	21	1	70	21
Picric Acid (10%)	2	160	71	2	70	21	1	140	60	2	70	21	1	300	149
Pinene	2	70	21	2	70	21	1	158	70	4	70	21	1	boiling	boiling
Piperidine	4	70	21	4	70	21	4	70	21	4	70	21	1	boiling	boiling
Plating Solution - Chrome	4	70	21	4	70	21	1	140	60	4	70	21	1	300	149
Plating Solution - Others	1	70	21	1	70	21	1	70	21	4	70	21	1	70	21
Potassium Acetate	2	120	49	2	70	21	4	70	21	4	70	21	1	390	199
Potassium Chloride	1	176	80	1	70	21	1	212	100	1	70	21	1	70	21
Potassium Cupro-Cyanide	1	140	60	1	70	21	1	212	100	1	70	21	1	70	21
Potassium Cyanide	1	140	60	1	70	21	1	70	21	1	70	21	1	200	93
Potassium Dichromate	1	140	60	1	70	21	1	212	100	1	70	21	1	200	93
Potassium Hydroxide	2	150	66	2	ND	ND	2	70	21	3	70	21	1	300	149

COMPOUND COMPATIBILITY CHART — APPENDIX C

Compound Code	MILL-RIGHT® N NBR			MILL-RIGHT® ES HNBR			MILL-RIGHT® V FKM			Silicone VMQ			GYLON® PTFE		
	Rating	°F	°C	Rating	°F	°C	Rating	°F	°C	Rating	°F	°C	Rating	°F	°C
Potassium Nitrate	1	140	60	1	70	21	1	212	100	1	70	21	1	300	149
Potassium Sulfate	1	160	71	1	70	21	1	212	100	1	70	21	1	300	149
Producer Gas	1	250	121	1	70	21	1	70	21	2	70	21	1	70	21
Propane	1	250	121	1	70	21	1	176	80	4	70	21	1	300	149
Propyl Acetate	4	70	21	4	70	21	4	70	21	4	70	21	1	70	21
N-Propyl Acetate	4	70	21	4	70	21	4	70	21	4	70	21	1	70	21
Propyl Acetone	4	70	21	4	70	21	4	70	21	3	ND	ND	1	70	21
Propyl Alcohol	2	200	93	1	70	21	1	212	100	1	70	21	1	300	149
Propyl Nitrate	4	70	21	4	70	21	4	70	21	4	70	21	1	70	21
Propylene	4	70	21	4	70	21	1	70	21	4	70	21	1	70	21
Propylene Oxide	4	70	21	4	70	21	4	70	21	4	70	21	1	300	149
Pydraul, 10E	4	70	21	4	70	21	1	70	21	4	70	21	1	70	21
Pydraul, 29ELT, 30E, 50E, 65E, 90E	4	70	21	4	70	21	1	158	70	1	70	21	1	70	21
Pydraul, 115E	4	70	21	4	70	21	1	70	21	4	70	21	2	400	204
Pyranol, Transformer Oil	1	70	21	1	70	21	1	70	21	4	70	21	ND	ND	ND
Rapeseed Oil	2	250	121	2	70	21	1	70	21	4	70	21	1	70	21
RJ-1 (MIL-F-25558)	1	70	21	1	70	21	1	70	21	4	70	21	ND	ND	ND
RP-1 (MIL-R-25576)	1	70	21	1	70	21	1	70	21	4	70	21	ND	ND	ND
SAE-10	1	250	121	1	70	21	1	70	21	4	70	21	1	70	21
SAE-30	1	70	21	1	70	21	1	70	21	1	ND	ND	ND	ND	ND
Sal Ammoniac	1	160	71	1	70	21	1	212	100	3	70	21	1	boiling	boiling
Salicylic Acid	2	70	21	2	70	21	1	70	21	1	ND	ND	1	300	149
Salt Water	1	140	60	1	70	21	1	176	80	1	70	21	1	250	121
Sea Water	1	140	60	1	70	21	1	212	100	1	70	21	1	250	121
Sewage	1	200	93	1	70	21	1	176	80	2	70	21	1	70	21
Silicate Esters	2	180	82	2	70	21	ND	400	204	4	70	21	1	70	21
Silicone Greases	1	140	60	1	70	21	1	140	60	3	70	21	1	300	149
Silicone Oils	1	140	60	1	70	21	1	400	204	4	70	21	1	300	149
Silver Nitrate	2	180	82	2	70	21	1	176	80	1	70	21	1	300	149
Soap Solutions	1	200	93	1	70	21	1	212	100	1	70	21	1	300	149
Soda Ash	1	160	71	1	70	21	1	212	100	1	70	21	1	300	149
Sodium Acetate	2	176	80	2	70	21	4	70	21	4	70	21	1	300	149
Sodium Bicarbonate	1	140	60	1	70	21	1	212	100	1	70	21	1	300	149
Sodium Bisulfite	2	212	100	1	70	21	1	212	100	1	70	21	1	200	93
Sodium Borate	1	70	21	1	70	21	1	176	80	1	70	21	1	300	149
Sodium Chloride	1	160	71	1	70	21	1	212	100	1	212	100	1	300	149
Sodium Cyanide	1	140	60	1	ND	ND	1	176	80	1	70	21	1	300	149
Sodium Hydroxide	2	70	21	2	70	21	2	70	21	1	70	21	1	300	149
Sodium Hypochlorite	4	130	54	2	70	21	1	158	70	2	70	21	1	300	149
Sodium Metaphosphate	1	140	60	1	70	21	1	140	60	1	70	21	1	300	149
Sodium Nitrate	2	176	80	2	ND	ND	1	212	100	4	70	21	1	300	149
Sodium Perborate	2	200	93	2	70	21	1	140	60	2	70	21	1	300	149
Sodium Peroxide	2	200	93	2	70	21	1	boiling	boiling	4	70	21	1	300	149
Sodium Phosphates	1	200	93	1	70	21	1	176	80	4	70	21	1	300	149
Sodium Silicate	1	140	60	1	70	21	1	212	100	1	70	21	1	300	149

Rating Key: 1 = Excellent compatibility up to given temperature
2 = Good compatibility up to given temperature

3 = Limited compatibility up to given temperature
4 = Poor compatibility up to given temperature

ND = No Data

COMPOUND COMPATIBILITY CHART — APPENDIX C

Compound Code	MILL-RIGHT® N NBR			MILL-RIGHT® ES HNBR			MILL-RIGHT® V FKM			Silicone VMQ			GYLON® PTFE		
	Rating	°F	°C	Rating	°F	°C	Rating	°F	°C	Rating	°F	°C	Rating	°F	°C
Sodium Sulfates	1	140	60	1	ND	ND	1	176	80	1	70	21	1	300	149
Sodium Thiosulfates	2	200	93	2	ND	ND	1	212	100	1	70	21	1	300	149
Soybean Oil	1	250	121	1	70	21	1	250	121	1	70	21	1	200	93
Stannic Chloride	1	140	60	1	70	21	1	140	60	2	70	21	1	300	149
Steam	4	212	100	4	212	100	1	212	100	4	225	107	1	450	232
Stearic Acid	1	70	21	2	70	21	1	140	60	2	70	21	1	300	149
Stoddards Solvent	1	250	121	1	70	21	1	158	70	4	70	21	1	300	149
Styrene Polymer	4	70	21	4	70	21	1	120	49	4	70	21	1	70	21
Sucrose Solution	1	140	60	2	70	21	1	140	60	1	70	21	1	200	93
Sulfur Chloride	4	70	21	4	70	21	1	140	60	3	70	21	1	300	149
Sulfur Hexafluoride	2	70	21	2	70	21	4	70	21	2	70	21	1	70	21
Sulfur Trioxide	4	70	21	4	70	21	1	140	60	2	70	21	1	300	149
Sulfuric Acid	4	70	21	4	70	21	1	158	70	4	70	21	1	400	204
Sulfur Acid (20% Oleum)	4	70	21	2	70	21	1	75	24	4	70	21	1	400	204
Sulfurous Acid	4	70	21	2	70	21	1	140	60	4	70	21	1	300	149
Tannic Acid	1	200	93	1	70	21	1	140	60	2	70	21	1	300	149
Terpineol	2	70	21	2	70	21	1	70	21	ND	ND	ND	1	70	21
Tertiary Butyl Alcohol	2	70	21	2	70	21	1	70	21	2	70	21	1	70	21
Tertiary Butyl Catechol	4	70	21	4	70	21	1	70	21	1	ND	ND	1	70	21
Tertiary Butyl Mercaptan	4	70	21	4	70	21	1	70	21	4	70	21	1	70	21
Tetrabromoethane	4	70	21	4	70	21	1	70	21	4	70	21	1	boiling	boiling
Tetrabromomethane	4	70	21	4	70	21	1	70	21	4	70	21	1	70	21
Tetrabutyl Titanate	2	70	21	2	70	21	1	70	21	ND	ND	ND	1	70	21
Tetrochloroethylene	4	70	21	4	70	21	1	212	100	4	70	21	1	250	121
Tetraethyl Lead	2	120	49	2	70	21	1	120	49	ND	ND	ND	1	300	149
Tetralin	4	70	21	4	70	21	1	70	21	4	70	21	1	70	21
Titanium Tetrachloride	4	70	21	2	70	21	1	ND	ND	4	70	21	1	300	149
Transformer Oil	1	150	66	1	70	21	1	300	149	2	70	21	1	300	149
Transmission Fluid Type A	1	70	21	1	70	21	1	212	100	2	70	21	1	70	21
Triaryl Phosphate	4	70	21	4	70	21	1	70	21	3	70	21	1	70	21
Tricresyl Phosphate	4	70	21	4	70	21	1	140	60	3	70	21	1	boiling	boiling
Turbine Oil	2	70	21	1	70	21	1	140	60	4	70	21	1	70	21
Turpentine	1	200	93	1	70	21	1	158	70	4	70	21	1	300	149
Varnish	2	70	21	2	70	21	1	70	21	4	70	21	1	70	21
Versilube F-50	1	70	21	1	70	21	1	350	177	3	70	21	1	70	21
Vinyl Chloride	4	70	21	4	70	21	1	70	21	1	ND	ND	1	300	149
Wagner 21B Brake Fluid	3	70	21	3	70	21	4	70	21	3	70	21	1	70	21
Water	1	180	82	1	70	21	2	275	135	2	180	82	1	boiling	boiling
White Oil	1	70	21	1	70	21	1	70	21	4	70	21	1	70	21
White Pine Tar	2	70	21	2	70	21	1	70	21	4	70	21	1	70	21
Xylene	4	70	21	4	70	21	1	140	60	4	70	21	1	300	149
Xylidines	4	70	21	ND	ND	ND	4	70	21	4	70	21	1	70	21
Zeolites	1	70	21	1	70	21	1	70	21	ND	ND	ND	ND	ND	ND
Zinc Acetate	2	176	80	2	70	21	4	176	80	4	70	21	1	70	21
Zinc Chloride	1	140	60	1	70	21	1	212	100	2	70	21	1	300	149
Zinc Sulfate	1	140	60	1	70	21	1	boiling	boiling	1	70	21	1	300	149

Damage Analysis Root Cause Identification

In the heavy industrial market, the damage of a single seal could result in product damage, lengthy equipment downtime, and additional maintenance costs.

When seal damage occurs, the user must quickly diagnose and implement a corrective action to minimize total cost of equipment downtime. To help maintenance and engineering personnel pinpoint the true source of damage, we have created a Fish Bone diagram which graphically organizes common symptoms with common root causes. The Fish Bone diagram is one of several fundamental Quality Control tools implemented extensively in problem solving. Developed by Kaoru Ishikawa in 1943, it is also called the Ishikawa diagram, cause and effect diagram, and root cause analysis tool.

The Fish Bone diagram is designed to help the user:

- Sort and segregate possible causes of problems in a logical manner
- Identify areas for data gathering
- Identify, explore, and graphically display, all of the possible causes related to a problem or condition to discover its root cause(s)
- Guide discussions and keep them focused

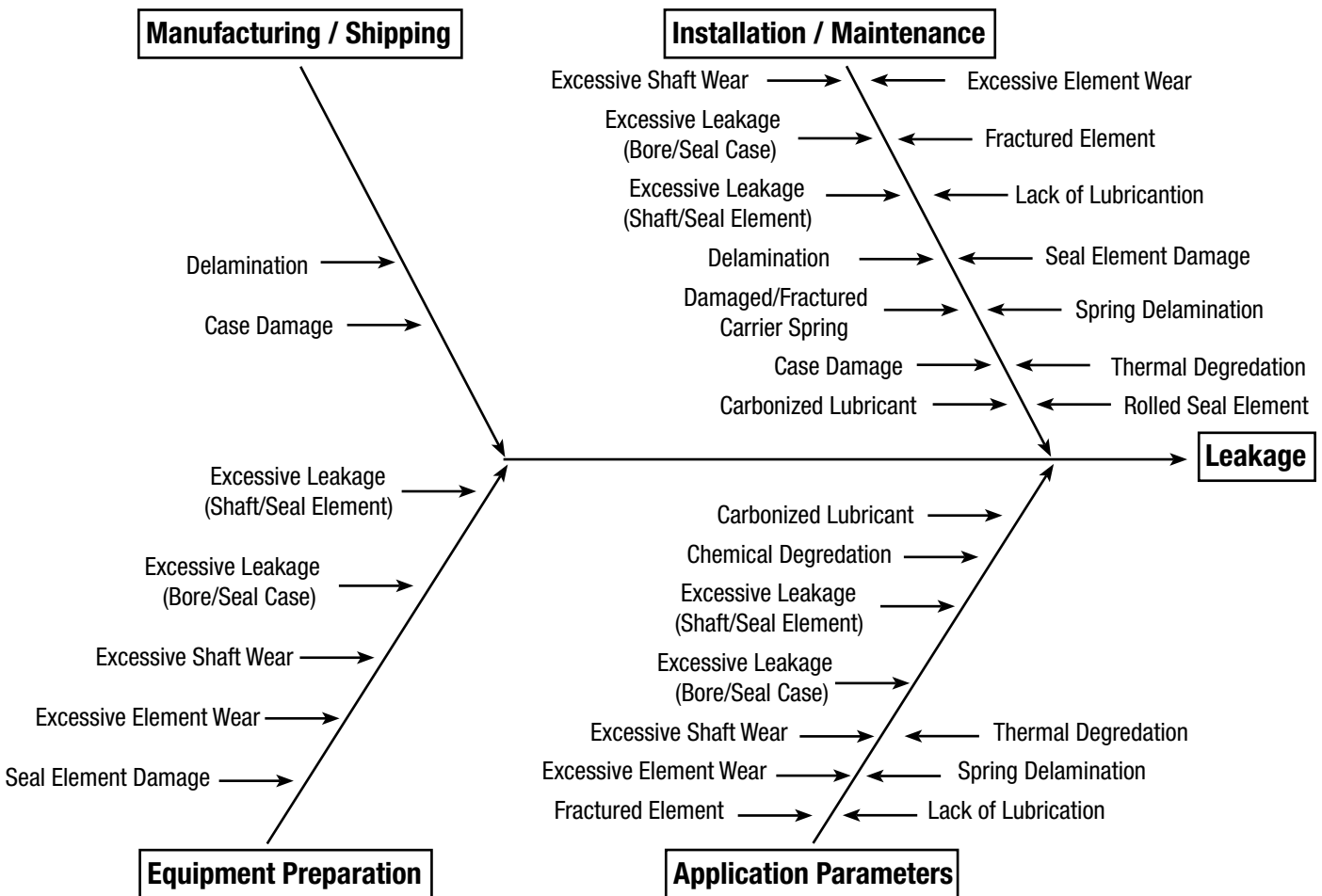

Reference Images – Damaged Seals

To help the user identify failure modes, the following images were compiled to serve as a reference.

Carbonized Lubricant

Problem

Degraded lubricant deposits around the sealing interface are evident.



Possible Source

Excessive lubricant temperature	Decrease the lubricant temperature or upgrade to a lubricant with higher temperature capabilities.
---------------------------------	--

Possible Solution

Delamination

Problem

The seal shows signs of delamination of the elastomer or bubbles within.



Possible Source

Installation damage	Modify installation technique to prevent damage to the seal.
Shipping damage	Contact your Garlock Klozure® representative.
Manufacturing error	Contact your Garlock Klozure® representative.

Possible Solution

Case Damage

Problem

The case of the seal is damaged.



Possible Source

Installation damage	Modify installation technique to prevent damage to the seal.
Shipping damage	Contact your Garlock Klozure® representative.

Possible Solution

Damaged/Fractured Carrier Spring

Problem

The carrier spring is damaged and/or fractured.



Possible Source

Installation damage	Modify installation technique to prevent damage to the seal.
Excessive loading of the seal element	Do not allow the seal to carry the weight of the shaft.

Possible Solution

Chemical Degredation

Problem

The seal element has abnormal swelling and/or distortion.



Possible Source

Incompatibility between the seal element and the material being sealed (i.e., lubricant, coolant, etc)	Upgrade to a compatible seal element.
--	---------------------------------------

Possible Solution

Excessive Leakage (Shaft/Seal Element)

Problem

Excessive leakage is occurring between the shaft and the seal lip.

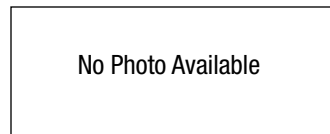

Possible Source

Improper seal/shaft size	Switch to a properly sized seal.
Rough shaft surface	Refinish shaft surface to seal specifications.
Excessive use of installation lubricant	Decrease the amount of installation lubricant being used.
Shaft machined lead (spiral grooves)	Refinish shaft surface to seal specifications.
Cocked seal installation	Ensure the seal is installed squarely into the housing bore.
Excessive shaft movement (TIR)	Move the seal closer to the bearings.

Possible Solution

Excessive Leakage (Bore/Seal Case)

Problem

Excessive leakage is occurring between the bore and the seal case.

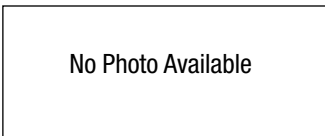

Possible Source

Possible Solution

Improper seal/bore size	Switch to a properly sized seal.
Rough bore surface	Refinish bore surface to seal specifications.
Use of installation lubricant	Do not use installation lubricant (not recommended for the bore and seal case).
Cocked seal installation	Ensure the seal is installed squarely into the housing bore.

Excessive Seal Element Wear

Problem

A wider than normal wear pattern on the surface of the seal element is present.



Possible Source

Possible Solution

High internal pressure	Clean drain ports and chamber vents or upgrade to a seal with higher pressure capabilities.
High misalignment/runout	Upgrade to a seal with higher misalignment/runout capabilities.
Rough shaft finish	Refinish shaft surface to seal specifications.
Lack of lubrication	Ensure the seal is properly lubricated.
Extended seal service	Upgrade to an extended service element material or update the maintenance schedule to accommodate new seal life requirements.
Oversized shaft	Switch to a properly sized seal.

Rolled Seal Element

Problem

The seal lip has been rolled over such that it does properly engage shaft.



Possible Source

Possible Solution

Installation damage	Modify installation technique to prevent damage to the seal. (Installation tool may be necessary)
---------------------	---

Fractured Seal Element

Problem

The seal element is fractured.



Possible Source

Possible Solution

Installation damage	Modify installation technique to prevent damage to the seal.
Excessive loading of the seal element	Do not allow the seal to carry the weight of the shaft.
Thermal degradation	Decrease the operating temperature or upgrade to a compatible seal element.
Lack of lubrication	Change or increase the amount of lubrication present at the sealing interface.

Lack of Lubrication

Problem

The seal element has surface cracks or irregular wear patterns.



Possible Source

Possible Solution

Insufficient lubrication level	Increase the lubrication level.
Excessive internal pressure	Decrease the internal pressure.

Excessive Shaft Wear

Problem

The shaft has an excessive wear groove.

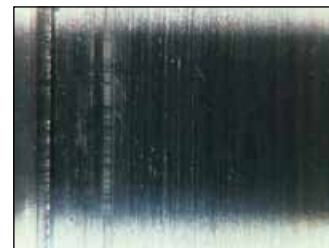

Possible Source

Possible Solution

Abrasive damage (installation)	Ensure the shaft and seal are clean prior to installing the seal.
Abrasive damage (operation)	Prevent abrasive materials from collecting at the sealing interface.
Soft shaft material	Ensure the shaft hardness meets the seal specifications.

Seal Element Damage

Problem
The seal element has nicks, cuts or tears.

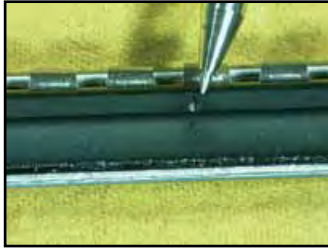

Possible Source

- Rough shaft finish
- Installation damage

Possible Solution

- Refinish shaft surface to seal specifications.
- Modify installation technique to prevent damage to the seal.

Thermal Degradation

Problem
The seal element is fractured (cracked).



Possible Source

- Excessive temperature

Possible Solution

- Decrease the operating temperature or upgrade to a seal material with higher temperature capabilities.

Spring Delamination

Problem
The spring delaminated from the seal element.



Possible Source

- Excessive loading of the seal element
- Excessive temperature

Possible Solution

- Upgrade to a seal with higher misalignment capabilities.
- Upgrade to a seal material with higher temperature capabilities.

KLOZURE APPLICATION INQUIRY FORM

Date: _____
 CS Rep: _____

Contact Information

Distributor End User
 Company: _____
 Contact Name: _____
 Phone: _____
 Email Address: _____
 Location: _____
 Fax: _____

Current Seal Information

Seal Manufacturer: _____
 Seal Part Number: _____
 Seal Type: _____
 Seal Element Material: _____
 Seal Case Material: _____
 Other: _____
 Other: _____
 Other: _____

Application Information

Shaft Diameter: _____ in mm
 Bore Diameter: _____ in mm
 Bore Depth: _____ in mm
 Motion (Rotary or Reciprocating) : _____
 Speed: _____ RPM fpm mps
 Shaft-to-Bore Misalignment (TIR) _____ in mm
 Pressure: _____ psi bar kp
 Media Type: _____
 Media Level: _____
 Temperature _____ F C
 Special Notes: _____

 Other: _____

KLOZURE Application Data Sheet for Split Pillow Block Bearing Isolators

Garlock Sealing Technologies, 1666 Division St., Palmyra, NY 14522
 Phone: 1-866-KLOZURE or 1-315-597-4811 Fax: 1-866-OILSEAL or 1-315-597-3140

Customer Information

Company: _____ Contact: _____
 Customer Type: _____ Title: _____
 Mailing Address: _____ Phone: _____
 City: _____ Fax: _____
 State: _____ Zip: _____ Email Address: _____

Current Seal Information

Seal Manufacturer: _____ Purity: _____
 Seal Part Number: _____ Approximate Cost: _____
 Seal Type: _____ Approximate Monthly Usage: _____
 Seal Material: _____ Approximate Annual Usage: _____
 Approximate Seal Life: _____ hrs days Usage Type: _____

Housing Dimensions

SAF Type

Housing Manufacturer: _____
 Housing #: _____
 LER/LOR #: _____
 Shaft Diameter: _____ in mm
 H: _____ in mm
 J: _____ in mm
 K: _____ in mm
 L: _____ in mm
 M: _____ in mm
 N: _____ in mm

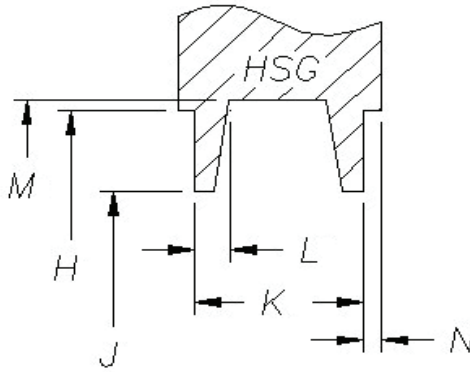

SNL/SNH Type

Housing Manufacturer: _____
 Housing #: _____
 Shaft Diameter: _____ in mm
 A₃: _____ in mm
 A₄: _____ in mm
 A₅: _____ in mm
 A₆: _____ in mm
 D_b: _____ in mm
 D_c: _____ in mm

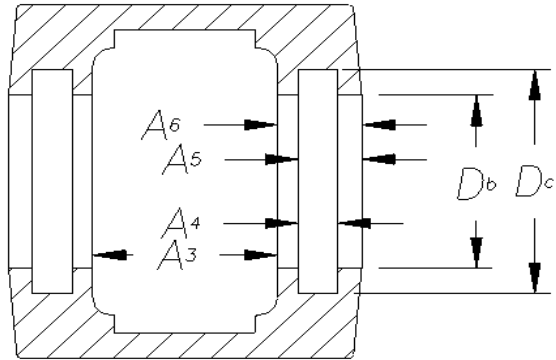

Application Information

Speed of Rotation: _____ RPM fpm mps
 Axial Movement: _____ in mm
 Radial Movement: _____ in mm
 Pressure: _____ psi bar kp
 Media Type: _____
 Media Level: _____
 Temperature: _____ F C
 Special Notes: _____
 Other: _____

Type of Seal Desired (select one)

- SOLID SEAL
- SPLIT SEAL

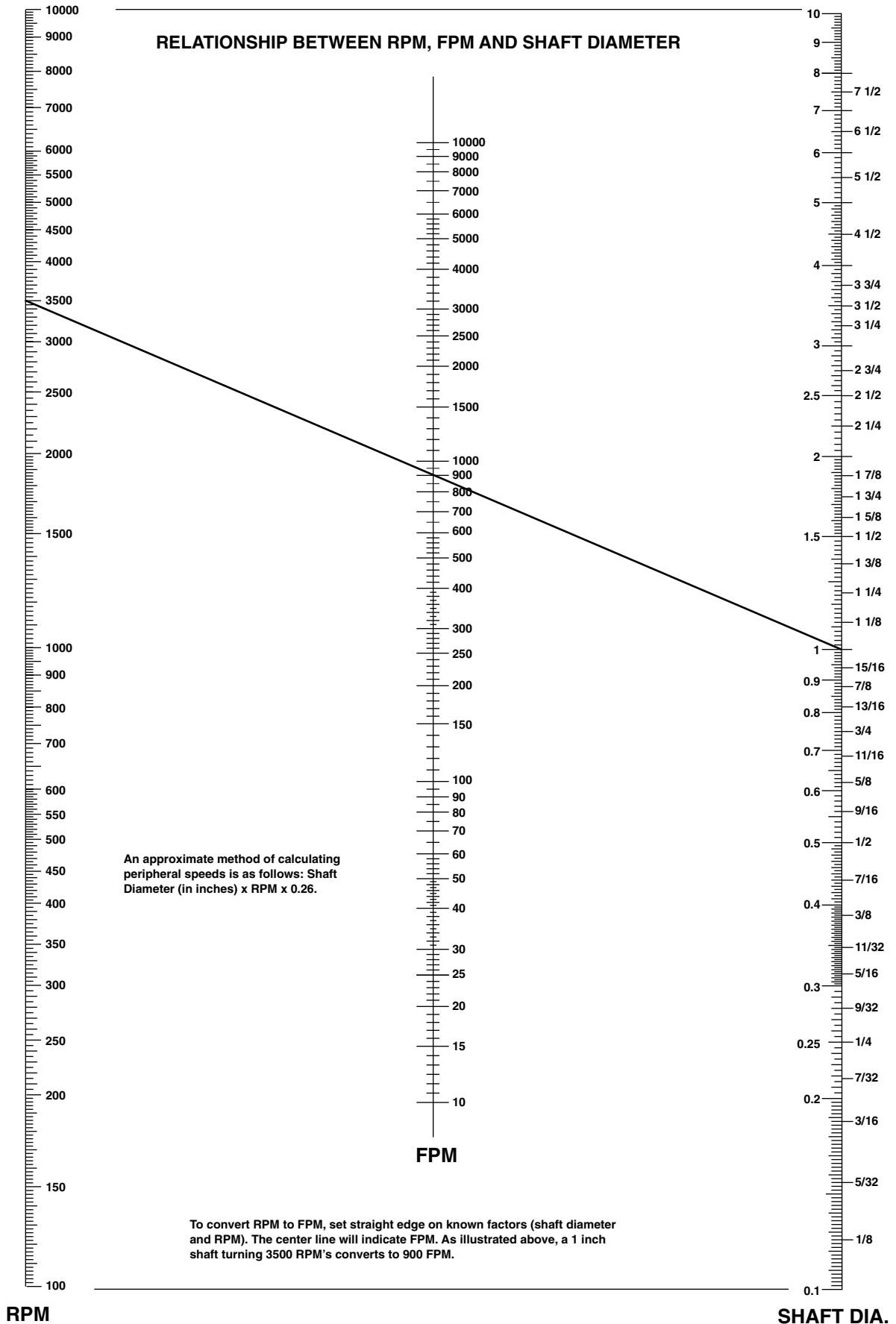

KLOZURE® HIGH-PERFORMANCE DYNAMIC SEALS

WARNING:

Properties/applications shown throughout this brochure are typical. Your specific application should not be undertaken without independent study and evaluation for suitability. For specific application recommendations consult Garlock Klozure. Failure to select the proper sealing products could result in property damage and/or serious personal injury.

Performance data published in this brochure has been developed from field testing, customer field reports and/or in-house testing.

While the utmost care has been used in compiling this brochure, we assume no responsibility for errors. Specifications subject to change without notice. This edition cancels all previous issues. Subject to change without notice.

GARLOCK is a registered trademark for packings, seals, gaskets, and other products of Garlock.

© Garlock 2010. All rights reserved worldwide.



A U T H O R I Z E D D I S T R I B U T O R

Garlock Sealing Technologies

1666 Division Street
 Palmyra, New York 14522 USA
 1.315.597.4811
 Fax: 1.315.597.3140
 Toll Free: 1.866.KLOZURE (1.866.556.9873)
 Toll Free Fax: 1.866.OILSEAL (1.866.645.7325)

Visit Klozure:

www.klozure.com
www.splitoilseal.com
www.microtec2.com
www.splitisolator.com

Other Garlock facilities are located in:

Paragould, AR, USA	Phone 1.870.239.4051	Fax 1.870.239.4054
Columbia, SC, USA	Phone 1.803.783.1880	Fax 1.803.783.4279
Houston, TX, USA	Phone 1.315.597.4811	Fax 1.315.597.3216
Denver, CO, USA	Phone 1.303.988.1242	Fax 1.303.988.1922
Sydney, Australia	Phone 61.2.9793.2511	Fax 61.2.9793.2544
Auckland, New Zealand	Phone 64.9573.5651	Fax 64.9573.5636
São Paulo, Brazil	Phone 55.11.4352.6161	Fax 55.11.4352.8181
Sherbrooke, Canada	Phone 1.819.563.8080	Fax 1.819.563.5620
W. Yorkshire, England	Phone 44.1422.313600	Fax 44.1422.313601
Saint-Étienne, France	Phone 33.4.7743.5100	Fax 33.4.7743.5151
Neuss, Germany	Phone 49.2131.3490	Fax 49.2131.349.222
Mexico City, Mexico	Phone 52.55.5078.4600	Fax 52.55.5368.0418
Singapore	Phone 65.6285.9322	Fax 65.6284.5843
Shanghai, China	Phone 86.021.64544412	Fax 86.021.34080906
Dubai, UAE	Phone 971.4.8833652	Fax 971.4.8833682
Pune, India	Phone 91.20.3061.6608	Fax: 91.20.3061.6699

KLZ 2:56

VIA-REV-F 07/10



an EnPro Industries company

