

PHIL RECESSED LED

WPUST



up to 50.000 h
do 50.000 h



5 years
5 lat



2200 lm, 4400 lm
6600 lm, 8800 lm



830, 840



PHILIPS

PHIL

RECESSED WPUST

LED

FORTIMO LED Strip
light source included
źródło światła w komplecie



PHIL recessed LED 2 • PHIL wpust LED 2

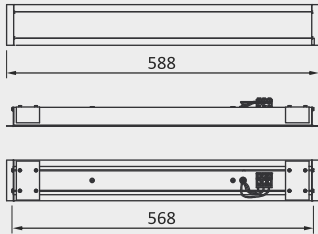

2 holders included • 2 uchwyty w komplecie

PHIL recessed LED 4 • PHIL wpust LED 4

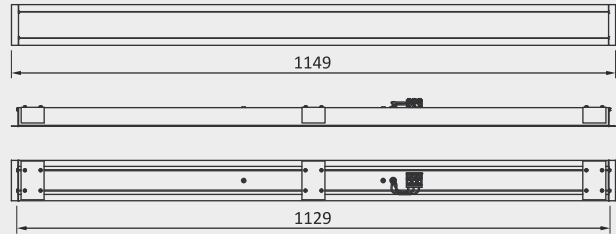

3 holders included • 3 uchwyty w komplecie

PHIL recessed LED 6 • PHIL wpust LED 6

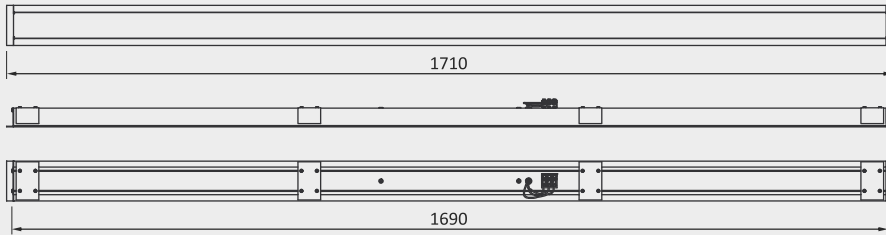

4 holders included • 4 uchwyty w komplecie

PHIL recessed LED 8 • PHIL wpust LED 8

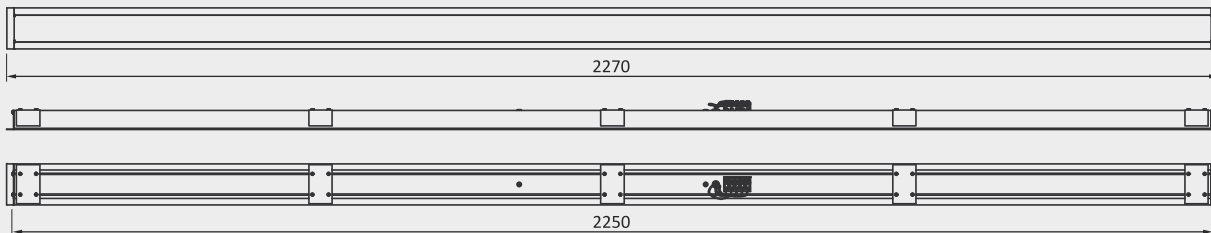

5 holders included • 5 uchwyty w komplecie

holder PH recessed, inox • uchwyt PH wpust, inox

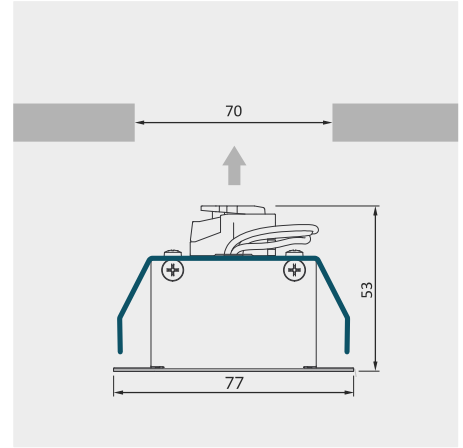
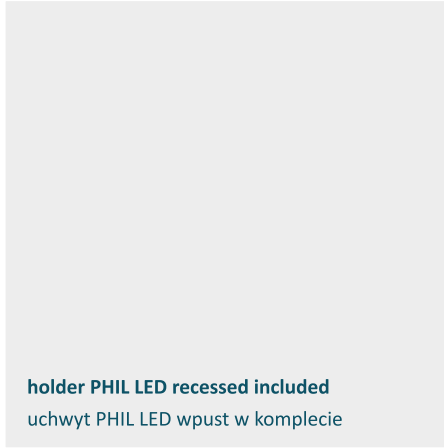
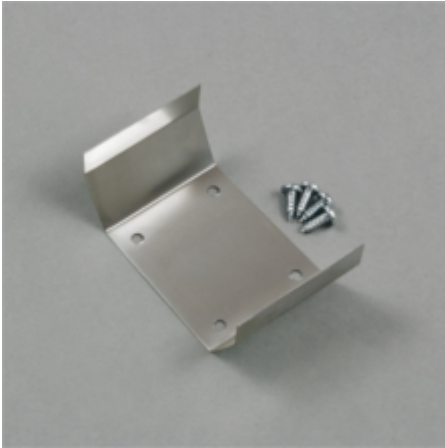

cover PH/LO/SM NARROW, light curve • klosz PH/LO/SM NARROW, krzywa światłości

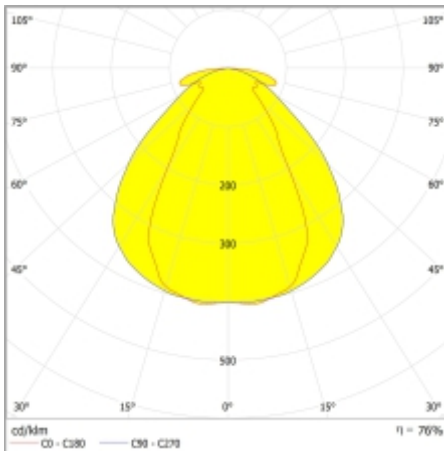
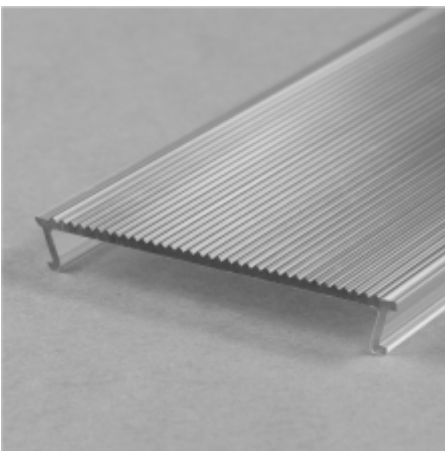

cover PH/LO/SM WIDE, light curve • klosz PH/LO/SM WIDE, krzywa światłości

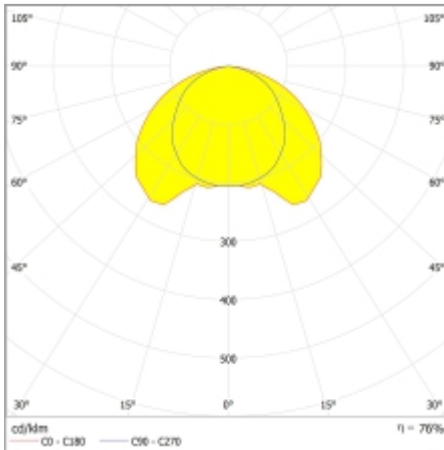
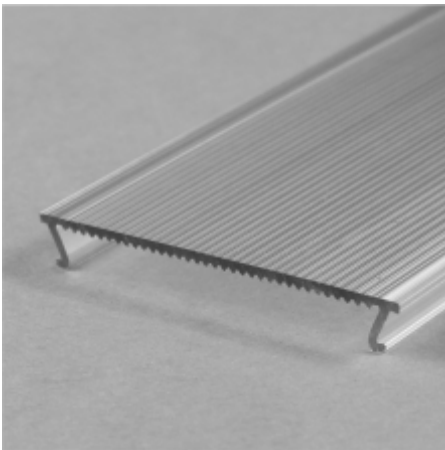

cover PH/LO/SM OPAL, light curve • klosz PH/LO/SM OPAL, krzywa światłości

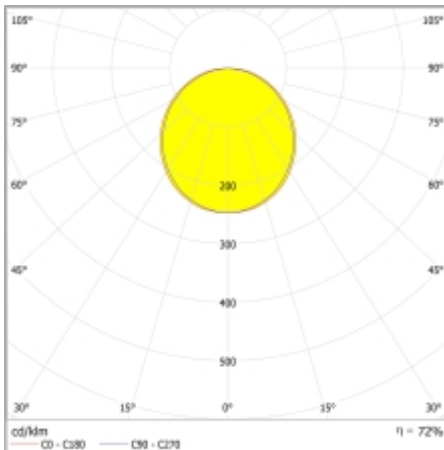
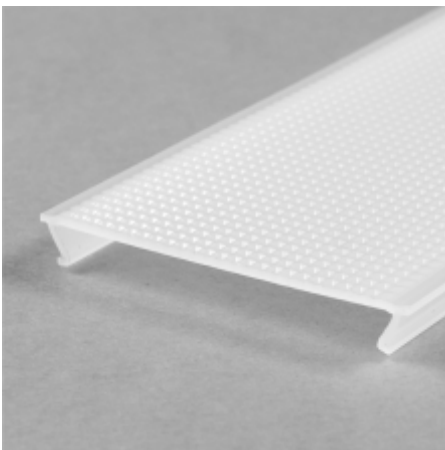

| product | length | lumen output | colour temperature | colour | input voltage | cover | order code |
|---|---------|------------------------------|---------------------|-------------------|---------------|--------|-----------------|
| produkt | długość | znamionowy strumień świetlny | temperatura barwowa | kolor wykończenia | napięcie | klosz | indeks handlowy |
| cover PH/LO/SM NARROW • klosz PH/LO/SM NARROW | | | | | | | |
| PHIL recessed LED 2 • PHIL wpust LED 2 | 588 | 2200 lm | 830 | white • biały | 230 V | NARROW | 97144401 |
| PHIL recessed LED 2 • PHIL wpust LED 2 | 588 | 2200 lm | 830 | anod. | 230 V | NARROW | 97144420 |
| PHIL recessed LED 2 • PHIL wpust LED 2 | 588 | 2200 lm | 840 | white • biały | 230 V | NARROW | 97164401 |
| PHIL recessed LED 2 • PHIL wpust LED 2 | 588 | 2200 lm | 840 | anod. | 230 V | NARROW | 97164420 |
| PHIL recessed LED 4 • PHIL wpust LED 4 | 1149 | 4400 lm | 830 | white • biały | 230 V | NARROW | 97188801 |
| PHIL recessed LED 4 • PHIL wpust LED 4 | 1149 | 4400 lm | 830 | anod. | 230 V | NARROW | 97188820 |
| PHIL recessed LED 4 • PHIL wpust LED 4 | 1149 | 4400 lm | 840 | white • biały | 230 V | NARROW | 97208801 |
| PHIL recessed LED 4 • PHIL wpust LED 4 | 1149 | 4400 lm | 840 | anod. | 230 V | NARROW | 97208820 |
| PHIL recessed LED 6 • PHIL wpust LED 6 | 1710 | 6600 lm | 830 | white • biały | 230 V | NARROW | 97229901 |
| PHIL recessed LED 6 • PHIL wpust LED 6 | 1710 | 6600 lm | 830 | anod. | 230 V | NARROW | 97229920 |
| PHIL recessed LED 6 • PHIL wpust LED 6 | 1710 | 6600 lm | 840 | white • biały | 230 V | NARROW | 97249901 |
| PHIL recessed LED 6 • PHIL wpust LED 6 | 1710 | 6600 lm | 840 | anod. | 230 V | NARROW | 97249920 |
| cover PH/LO/SM WIDE • klosz PH/LO/SM WIDE | | | | | | | |
| PHIL recessed LED 2 • PHIL wpust LED 2 | 588 | 2200 lm | 830 | white • biały | 230 V | WIDE | 97134401 |
| PHIL recessed LED 2 • PHIL wpust LED 2 | 588 | 2200 lm | 830 | anod. | 230 V | WIDE | 97134420 |
| PHIL recessed LED 2 • PHIL wpust LED 2 | 588 | 2200 lm | 840 | white • biały | 230 V | WIDE | 97154401 |
| PHIL recessed LED 2 • PHIL wpust LED 2 | 588 | 2200 lm | 840 | anod. | 230 V | WIDE | 97154420 |
| PHIL recessed LED 4 • PHIL wpust LED 4 | 1149 | 4400 lm | 830 | white • biały | 230 V | WIDE | 97178801 |
| PHIL recessed LED 4 • PHIL wpust LED 4 | 1149 | 4400 lm | 830 | anod. | 230 V | WIDE | 97178820 |
| PHIL recessed LED 4 • PHIL wpust LED 4 | 1149 | 4400 lm | 840 | white • biały | 230 V | WIDE | 97198801 |
| PHIL recessed LED 4 • PHIL wpust LED 4 | 1149 | 4400 lm | 840 | anod. | 230 V | WIDE | 97198820 |
| PHIL recessed LED 6 • PHIL wpust LED 6 | 1710 | 6600 lm | 830 | white • biały | 230 V | WIDE | 97219901 |
| PHIL recessed LED 6 • PHIL wpust LED 6 | 1710 | 6600 lm | 830 | anod. | 230 V | WIDE | 97219920 |
| PHIL recessed LED 6 • PHIL wpust LED 6 | 1710 | 6600 lm | 840 | white • biały | 230 V | WIDE | 97239901 |
| PHIL recessed LED 6 • PHIL wpust LED 6 | 1710 | 6600 lm | 840 | anod. | 230 V | WIDE | 97239920 |
| cover PH/LO/SM OPAL • klosz PH/LO/SM OPAL | | | | | | | |
| PHIL recessed LED 2 • PHIL wpust LED 2 | 588 | 2200 lm | 830 | white • biały | 230 V | OPAL | 97254401 |
| PHIL recessed LED 2 • PHIL wpust LED 2 | 588 | 2200 lm | 830 | anod. | 230 V | OPAL | 97254420 |
| PHIL recessed LED 2 • PHIL wpust LED 2 | 588 | 2200 lm | 840 | white • biały | 230 V | OPAL | 97264401 |
| PHIL recessed LED 2 • PHIL wpust LED 2 | 588 | 2200 lm | 840 | anod. | 230 V | OPAL | 97264420 |
| PHIL recessed LED 4 • PHIL wpust LED 4 | 1149 | 4400 lm | 830 | white • biały | 230 V | OPAL | 97278801 |
| PHIL recessed LED 4 • PHIL wpust LED 4 | 1149 | 4400 lm | 830 | anod. | 230 V | OPAL | 97278820 |
| PHIL recessed LED 4 • PHIL wpust LED 4 | 1149 | 4400 lm | 840 | white • biały | 230 V | OPAL | 97288801 |
| PHIL recessed LED 4 • PHIL wpust LED 4 | 1149 | 4400 lm | 840 | anod. | 230 V | OPAL | 97288820 |
| PHIL recessed LED 6 • PHIL wpust LED 6 | 1710 | 6600 lm | 830 | white • biały | 230 V | OPAL | 97299901 |
| PHIL recessed LED 6 • PHIL wpust LED 6 | 1710 | 6600 lm | 830 | anod. | 230 V | OPAL | 97299920 |
| PHIL recessed LED 6 • PHIL wpust LED 6 | 1710 | 6600 lm | 840 | white • biały | 230 V | OPAL | 97309901 |
| PHIL recessed LED 6 • PHIL wpust LED 6 | 1710 | 6600 lm | 840 | anod. | 230 V | OPAL | 97309920 |
| PHIL LED recessed DALI - dimmable • PHIL LED wpust DALI - ściemniały | | | | | | | |
| PHIL recessed LED 8 • PHIL wpust LED 8 | 2270 | 8800 lm | 830 | white • biały | 230 V | NARROW | 97329901 |
| PHIL recessed LED 8 • PHIL wpust LED 8 | 2270 | 8800 lm | 830 | anod. | 230 V | NARROW | 97329920 |
| PHIL recessed LED 8 • PHIL wpust LED 8 | 2270 | 8800 lm | 840 | white • biały | 230 V | NARROW | 97359901 |
| PHIL recessed LED 8 • PHIL wpust LED 8 | 2270 | 8800 lm | 840 | anod. | 230 V | NARROW | 97359920 |
| PHIL recessed LED 8 • PHIL wpust LED 8 | 2270 | 8800 lm | 830 | white • biały | 230 V | WIDE | 97319901 |
| PHIL recessed LED 8 • PHIL wpust LED 8 | 2270 | 8800 lm | 830 | anod. | 230 V | WIDE | 97319920 |
| PHIL recessed LED 8 • PHIL wpust LED 8 | 2270 | 8800 lm | 840 | white • biały | 230 V | WIDE | 97349901 |
| PHIL recessed LED 8 • PHIL wpust LED 8 | 2270 | 8800 lm | 840 | anod. | 230 V | WIDE | 97349920 |
| PHIL recessed LED 8 • PHIL wpust LED 8 | 2270 | 8800 lm | 830 | white • biały | 230 V | OPAL | 97339901 |
| PHIL recessed LED 8 • PHIL wpust LED 8 | 2270 | 8800 lm | 830 | anod. | 230 V | OPAL | 97339920 |
| PHIL recessed LED 8 • PHIL wpust LED 8 | 2270 | 8800 lm | 840 | white • biały | 230 V | OPAL | 97369901 |
| PHIL recessed LED 6 • PHIL wpust LED 8 | 2270 | 8800 lm | 840 | anod. | 230 V | OPAL | 97369920 |

brochure designer • proj. folderu: Michał Kędziora 05.12.2015. photo • fot. Katarzyna Samulńska

PHIL LED recessed TL5 G5 fluorescent luminaire - available for special order
PHIL LED wpust TL5 G5 oprawa świetłówkowa - dostępna na specjalne zamówienie

The catalogue is not an offer under Polish Civil Code regulations. Colours of particular products may vary slightly from colours shown in pictures. The dimensions given are approximate and can not be a reason for complaint. TOPMET Company reserves the right to make technical changes.

Folder nie stanowi oferty w myśl przepisów Kodeksu Cywilnego. Aktualną ofertę firmy stanowi cennik. Kolory poszczególnych produktów mogą się nieznacznie różnić od kolorów prezentowanych na zdjęciach. Podane wymiary są wymiarami orientacyjnymi i nie mogą stanowić podstawy reklamacji. Firma TOPMET zastrzega sobie prawo do wprowadzania zmian technicznych.

TOPMET Light K. Kłósowicz M. Wiśniewski Sp. J. ADDRESS: Ostrowska 354, 61-312 Poznań, POLAND
tel. +48 61 87 27 500, fax. +48 61 87 27 518 biuro@topmet.pl, www.topmet.pl