

emcogroup

Designed for your profit

[That's
E[M]CONOMY:]



Complete Solutions – unlimited Possibilities. EMCO MAXXTURN 45

Universal machining center for the complete machining
of bar stock and chuck work

EMCO MAXXTURN 45

[Y axis]

- Travel +40 / -30 mm
- 90° implemented in the machine construction
- Large distance between guide rails stable and compact construction, without restrictions

[Workspace]

- Plenty of open space
- Optimal chip flow
- Easily accessible

[Hydraulic unit]

- Ergonomically placed
- Automatic pressure control switching and adjustment
- Optimal overview

[Machine design]

- Compact
- Requires minimal floor space



Machine with optional equipment

The EMCO MAXXTURN 45. The perfect solution for economic, off-the-shelf complete machining. Fitted with a counter spindle, driven tools, a high-precision C axis and extremely fast rapid motion speeds, the MAXXTURN 45 gives you everything you need for manufacturing complex turned-milled parts efficiently and at a low price. The highlight of the machine is its very stiff Y axis with long travel – for almost unlimited machining capabilities with maximum precision. The MAXXTURN 45 comes with a choice of Siemens or Fanuc control and with Shopturn or ManualGuide i as standard equipment.

[Workpieces]

[Control system]

- Ergonomically placed
- Siemens or Fanuc
- LCD color monitor, including ShopTurn or ManualGuide i
- Teleservice, Ethernet connection and PC keyboard available as options

[Shelf]

- Retractable
- Enough space for gauges and operating tools

[Machine cover]

- All-round protection against chips
- 100% coolant retention
- Large safety glass window in door
- Clear view of the workspace
- Built-in buttons for operator convenience



Distributor
(Brass)



Camshaft
(Brass)



Eccentric disc
(Aluminium)



Push-on contact
(Steel)

[Engineering]

Highlights

- Very high thermostability
- Extremely machining precision
- High rapid motion speeds
- Very stable Y axis with long travel
- High-precision C axis
- Driven tools
- Very compact machine layout
- Cutting-edge control technology from Siemens or Fanuc
- Simple, dialog-supported programming
- Made in the Heart of Europe

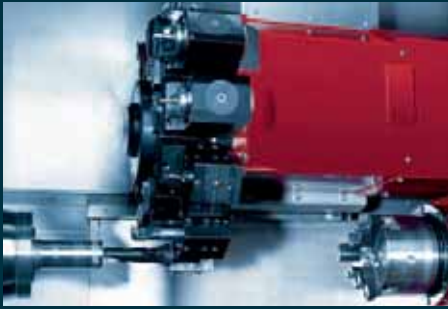

Tool head. 12-position VDI 25 radial turret with single-motor engineering. A servo motor powers the driven tools and the swivel movement. No tool rise. Switches with bidirectional logic. Every station can hold driven tool holders with a DIN 5480 coupling.



Main spindle. The main spindle with large precision bearings allows a very wide range of speeds, combined with extremely good true running characteristics. Cooling fins are fitted to the symmetrical headstock to ensure optimum thermal stability.



Counter spindle and parts catcher. The counter spindle includes a parts ejector with stroke monitoring and coolant feed. It ejects the parts automatically into the parts catcher, which then removes them from the machine and stores them in a bin or on an accumulating conveyor.



Tailstock. On the MAXXTURN 45 with tailstock, the tailstock is set up on the linear roller slide and can be automatically positioned within a range of 510 mm. The live center is integrated into the body of the tailstock and can be removed using a pressure wedge.

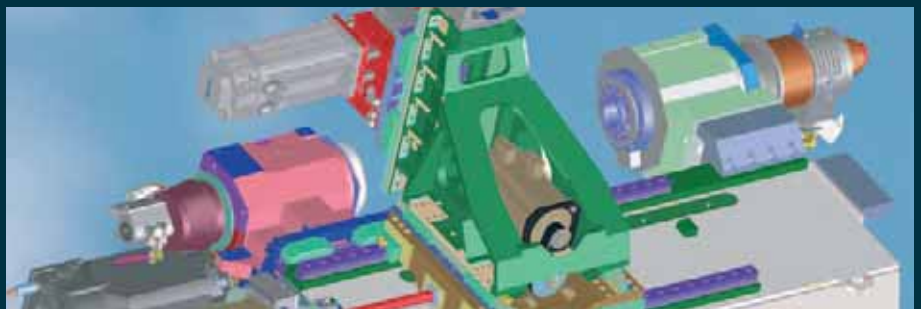

Y axis. The Y axis is integrated into the basic machine structure and stands at 90° to the X axis. Extremely short projections form the basis for solid turning and drilling operations, as well as milling operations without interference contours.

Versions EMCO MAXXTURN 45

MT 45 MY with tailstock, Y and C axes and driven tools

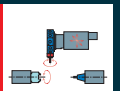

MT 45 S with counter spindle

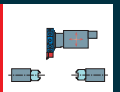

MT 45 SM with counter spindle, 2 C axes and driven tools

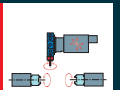

MT 45 SMY with counter spindle, Y axis, 2 C axes and driven tools

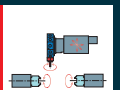

Power

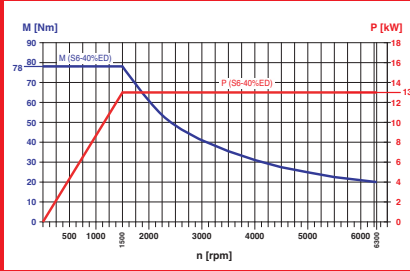

Main spindle motor characteristics

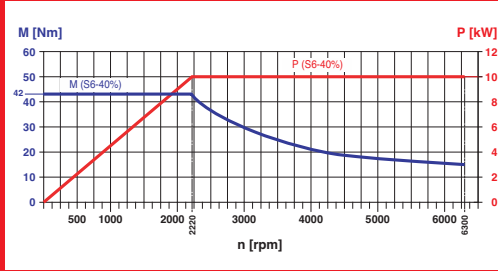

Counter spindle characteristics

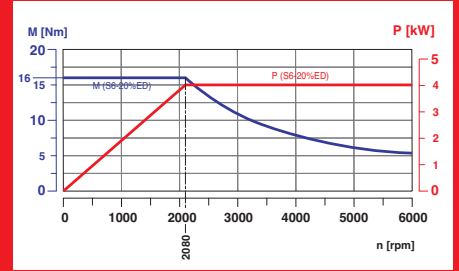

Tool turret motor characteristics
Driven tools

[Main spindle]

- High drive power
- Compact, thermostable construction
- Large speed range
- A 2-5 spindle nose
- Bar capacity diameter 45 mm (1.8")

[Tool turret]

- VDI quick change system
- 12 driven tool stations
- No alignment of the tool holder
- Can be used on both spindles
- Swivel speed adjustable with override

[Machine base]

- Extremely stiff welded steel fabrication
- Compact structure
- Very high thermostability
- Filled with vibration-absorbing material

[Counter spindle]

- Large speed range
- C axis
- Spindle clamp
- A 2-4 spindle nose

[Roller guides]

- In all linear axes
- Preloaded
- No backlash in any direction of force
- High rapid motion speeds
- No wear
- Minimal lubrication

[Machine stand]

- Thermally isolated from the machine base
- Coolant container that is larger and easier to clean
- 100% sealed against coolant leaks

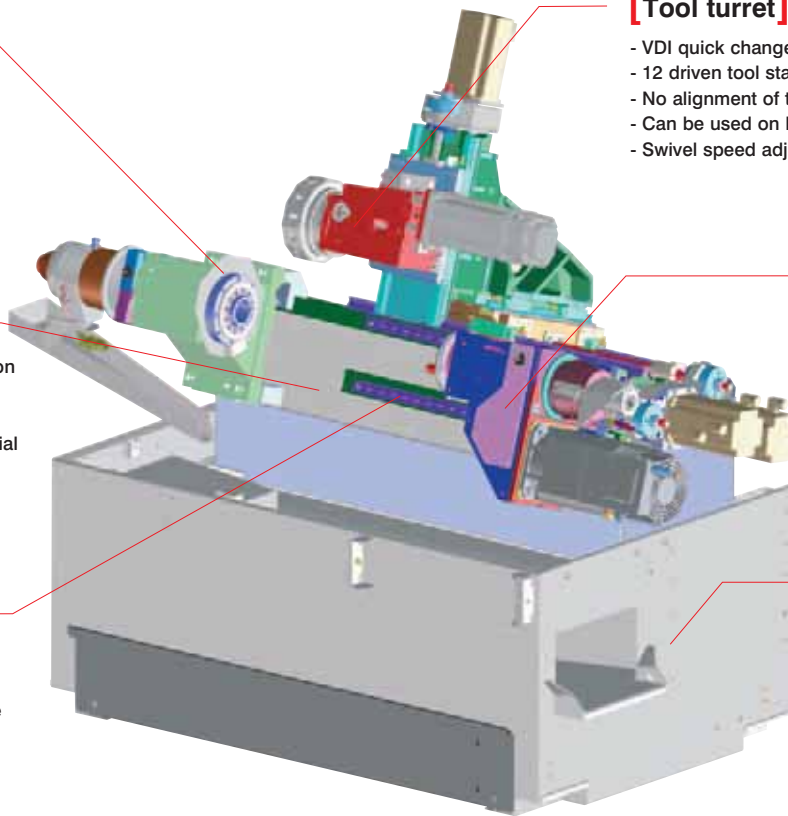

Work area

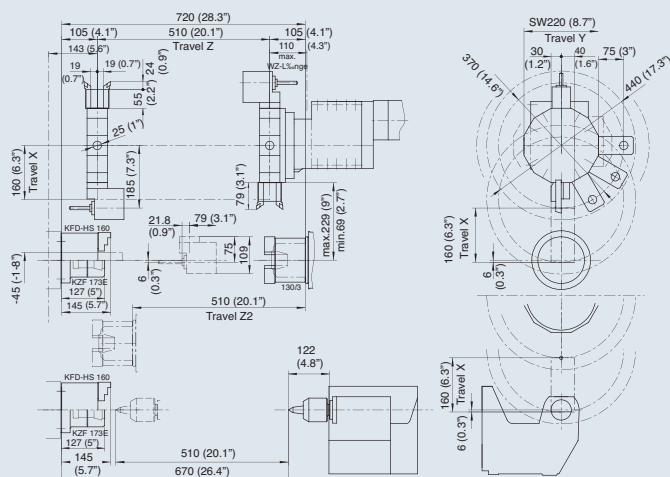

Machine layout

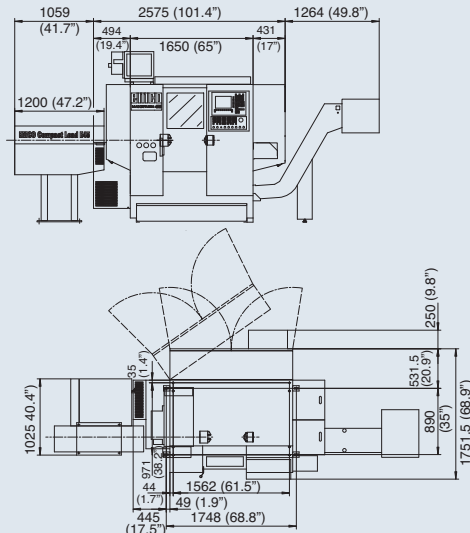

Individual automation with the EMCO swing loader

Tailor-made solutions. For preformed blanks and parts with a diameter larger than the spindle capacity, we offer an integrated swing loader for fully automatic loading and part removal. This has been designed to form a harmonious single entity with the machine. The machine control system takes care of positioning. A short bar loader and a 3-meter bar loader are available from EMCO for workpieces from bar stock.



Blank feeding systems

Feed systems specific to particular blanks allow preformed workpieces to be loaded in the working spindle correctly oriented, which enables economical unmanned operation.



Large storage capacity chain feeding system for loading preformed blanks with the correct orientation.



Multiple infeed chutes for loading rotationally-symmetrical blanks. The length of the blanks determines the number of infeed chutes.



Chain feeding system with V-supports for preformed shaft parts of various shapes.

Customization:

A wide range of gripper and handling systems are available.



2-finger gripper with 180° rotary module for loading blanks fed in vertically



2-finger toggle lever gripper for loading shaft parts

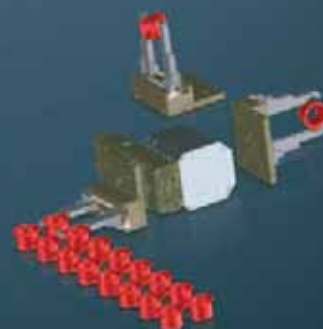

Parallel grippers with 180° rotary module for loading shaft parts (1st and 2nd chucking)

[EMCO TOP LOAD 8-42]

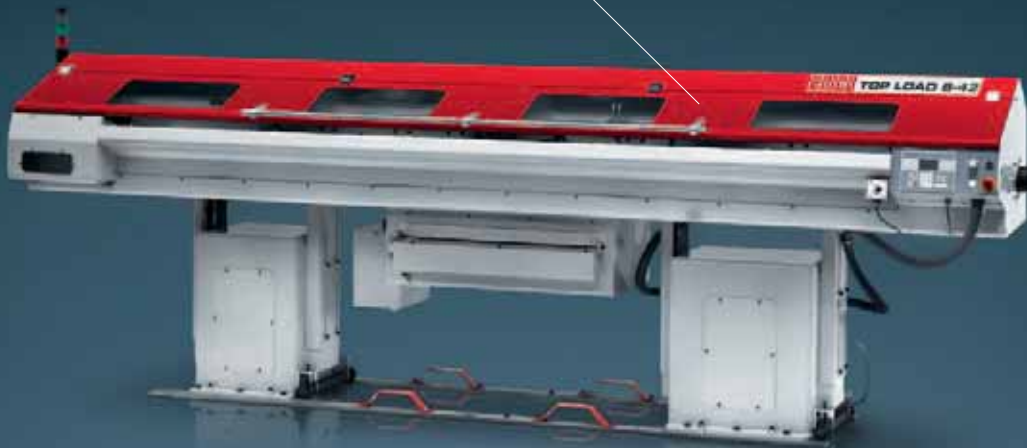

Short and to the point

In view of the ever-increasing pressure on floorspace for machines, EMCO has developed the most compact short loader on the market: the EMCO LM800.



Finished part conveyor

The finished-part pick-up device puts the parts on an accumulating conveyor. A discontinuous belt ensures that the often very complex parts do not fall onto each other.



Unloading through the counter spindle

Long, slender workpieces can be removed from the machine through the counter spindle. Long parts can be stowed in different ways. The finished parts can either simply roll down an inclined surface, or be stored in a lateral magazine using a discontinuous belt.

X	aktuell	4.111 128%	4.4000000%	4.221 121%	Bruch Verschl:
	letzter	299.999 99%	0.0000000%	18.501 531%	min. 50%
	geplant	3.231	3.571	3.001	max. 55%
Z	aktuell	0.471 47%	1.501 93%	0.721 88%	Bruch Verschl:
	letzter	299.999 99%	0.001 10%	4.591 437%	min. 50%
	geplant	0.991	1.401	1.101	max. 55%
Y	aktuell	0.701 70%	5.471 89%	0.871 79%	Bruch Verschl:
	letzter	299.999 99%	0.001 99%	0.641 10%	min. 50%
	geplant	5.251	6959	6.001	max. 55%
C	aktuell	0.111 10%	20.671 52%	12.001 80%	Bruch Verschl:
	letzter	299.999 9%	0.001 100%	37.501 148%	min. 50%
	geplant	7.401	39.971	36.001	max. 55%



Band filter with high-pressure coolant pumps

A coolant pressure of 25/40/60 or 80 bar can be set as needed. This enables coolant-fed drilling and milling tools to be used to their best advantage.

Quality components



[Machine bases and slides]

When matching components, we place great value on high stability, good damping characteristics, and a thermoneutral design. We achieve high stability through a shorter force flow, thermal stability through symmetry, and dampening through the materials and interfaces selected.



www.emco-magdeburg.de

[Headstocks]

The design and manufacture of headstocks are two of EMCO's core competencies. During engineering, the focus is on precision, robustness, high rigidity, precise rotational characteristics, and a long service life.



www.emco-magdeburg.de

[Tool turret]

Rapid-indexing turrets with adjustable swivel speeds and milling drives represent the current state of the art. The backlash-free milling drive is not only ideal for milling and drilling, but also for rigid tapping, hobbing, and polygonal turning.

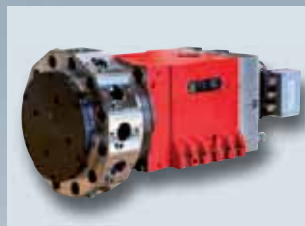

www.sauter-feinmechanik.com

[Tool holder]

Innovative, fully developed tool holder systems form the basis for cost-effective machining. High changeover accuracy and stability result in short setup and cycle times.

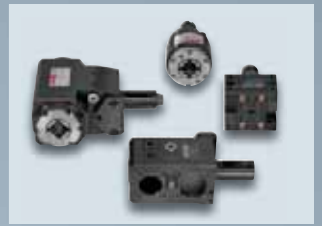

www.wto.de

[Clamping cylinder / chuck]

Hydraulically activated clamping cylinders and chucks guarantee the precise, safe clamping of work pieces. Programmable sensors are used for stroke monitoring. There is no need for time-consuming adjustments of contactless limit switches.



www.roehm.biz

[Hydraulic systems]

Compact dimensions, quiet operation, and high energy efficiency - just some of the advantages of the hydraulic assemblies used by EMCO. Monitored pressure switches prevent the need for time-consuming manual pressure adjustments.



www.hawe.de

[Ball screws and roller guides]

Highly precise and generously dimensioned guide rails and ball screws with optimal pretensioning form the basis for the machining of precision parts.



www.boschrexroth.com

[Chip conveyor]

Slat band conveyors allow for flexible implementation and the safe removal of chips. A monitored overload clutch prevents damage from improper use.



www.knollmb.de

[Coolant pumps]

Low-maintenance immersion pumps for pressures of up to 25 bar and flow rates of up to 1500 l/min provide optimum conditions for machining and enable reliable chip transportation.



www.grundfos.at

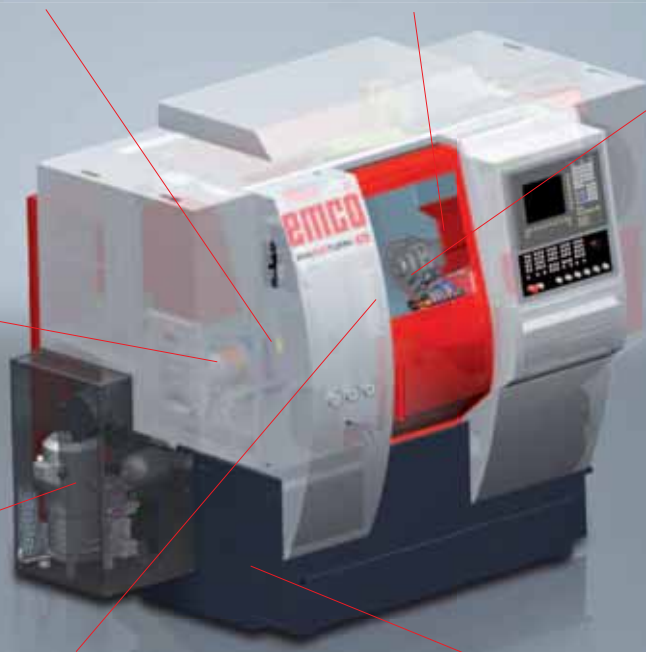

Minimum use of resources for maximum profit.

E[M]COLOGY
Designed for Efficiency

At EMCO, we take a consistent, responsible approach to the use of resources in machine tools in order to safeguard long-term investments. From the development of our machines through to their construction and manufacture, we place a strong focus on the sensible and sparing use of raw materials and energy. This enables us to achieve parallel savings in two areas:

1. Reduction in the basic power consumption of machine tools, e.g. assemblies are switched on and off as required and the installed connected loads are kept to a minimum.
2. Reduction in variable consumption: This can be seen in the lighter axes, energy recovery system, increased rate of good parts, and the shorter process chain enabled by complete machining.

Through these measures, which are constantly being refined and further optimized, EMCO truly demonstrates that its slogan of „Designed for your Profit“ is not just an empty promise: EMCO products help save the environment and provide intelligent customer savings without compromising on quality and flexibility.



[Regenerative drive system]

Kinetic energy is converted into electrical energy and fed back into the grid.
Savings of up to 10%

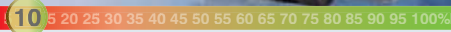

[Compact hydraulics unit with pressure accumulator]

Thanks to its accumulator charging system, the pump only runs when required. If the pressure accumulator is full, the pump switches over to closed loop circulation.
Savings of up to 90%



[Roller guides]

Extremely low friction losses thanks to rolling friction. Highly dynamic performance with minimal lubricant consumption.
Savings of up to 50%



[Structurally optimized mechanics]

FEM analysis is used to optimize the relevant components in terms of their rigidity while simultaneously reducing their weight.
Savings of up to 10%

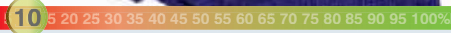
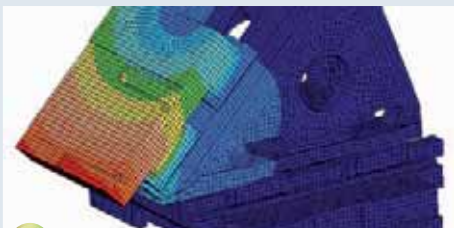

[Highly efficient motors]

The use of energy-efficient motors (IE2) in the coolant preparation area guarantee highly cost-effective operation.
Savings of up to 10%

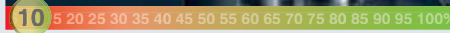

[Synchronized chip conveyor]

Programmable interval times enable optimal use of the chip conveyor independently of the machining process.
Savings of up to 95%

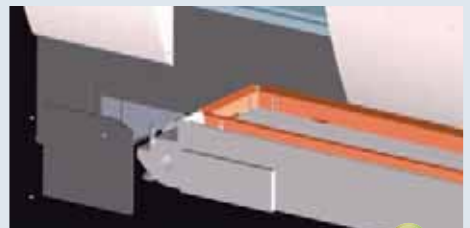

[Intelligent standby concepts]

Reduced consumption by automatically switching off ancillary units and machine space/screen illumination after a defined period of inactivity on the control panel.
Savings of up to 50%

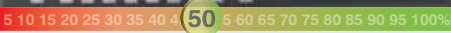

[Virtual machine]

Significant reduction in the setup and running-in times on the machine through the use of highly developed simulation and programming software.
Savings of up to 85%

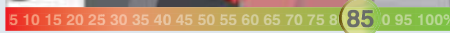

[Intelligent energy management]

Intuitive data entry screens for activating the individual energy-saving functions.
Savings of up to 70%

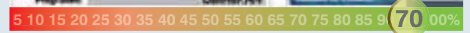

[Technical Data]



Designed for your profit

EMCO MAXXTURN 45

Work area	
Swing over bed	430 mm (16.9")
Swing over cross slide	300 mm (11.8")
Main spindle / counter spindle distance	720 mm (28.3")
Max. turning diameter	300 mm (11.8")
Maximum part length	480 mm (18.9")
Maximum bar diameter (optional)	45 (51) mm (1.8 (2"))
Travel	
Travel in X / Z	160 / 510 mm (6.3 / 20.1")
Travel in Y	+40 / -30 mm (+1.6 / -1.2")
Main spindle	
Speed range	0 – 6300 (5000) rpm
Torque at spindle (optional)	78 (100) Nm (57.5 (73.7) ft/lbs)
Spindle nose DIN 55026	A 2-5
Spindle bearing (inner diameter at front)	80 mm (3.1")
Spindle bore hole	53 mm (2.1")
Counter spindle	
Speed range	0 – 6300 rpm
Torque at spindle (Siemens / Fanuc)	42 / 43 Nm (31 / 31.7 ft/lbs)
Spindle nose DIN 55026	A 2-4
Spindle bearing (inner diameter at front)	70 mm (2.6")
C axis	
Resolution	0.001°
Rapid motion speed	1000 rpm
Spindle indexing (disc brake)	0.01°
Tailstock	
Tailstock travel	510 mm (20")
Maximum thrust	6000 N (1350 lbs)
Maximum travel speed	approx. 20 m/min (790ipm)
Tailstock bore taper	MT 4
Drive power	
Main spindle	13 kW (17.4 hp)
Counter spindle (Siemens / Fanuc)	10 / 7.5 kW (13.41 / 10.1 hp)
Tool turret	
Number of tool positions	12
VDI shaft (DIN 69880)	VDI 25

Tool turret	
Tool cross-section for square tools	16 x 16 mm (0.6 x 0.6")
Shaft diameter for boring bars	25 mm (1")
Turret indexing time	0.2 sec
Driven tools	
Speed range	0 – 6000 rpm
Maximum torque	16 Nm (11.8 ft/lbs)
Maximum drive power	4 kW (5.4 hp)
Number of driven tools	12
Feed drives	
Rapid motion speed X / Y / Z	24 / 10 / 30 m/min (944.9 / 393.7 / 1181.1 ipm)
Feed force in the X / Y axes	4000 / 4000 N (899.2 / 899.2 lbs)
Feed force in the Z axis	6000 N (1345 lbs)
Acceleration time from 0 to rapid X / Z	0.1 sec
Positioning scatter Ps VDI 3441 in X / Y / Z	3 / 3 / 3 μm (0.0001 / 0.0001 / 0.0001")
Coolant system	
Tank volume	250 liters (66.1 gal)
Pump power standard	0.57 (2.2) kW (0.76 (2.95) hp)
Pump capacity at 3,5 bar / 1 bar	15 / 65 l/min (3.9 / 17.2 gal/min)
Pump capacity at 10 bar / 5 bar (optional)	5 / 50 l/min (1.3 / 13.2 gal/min)
Power consumption	
Connected load	25 kVA
Compressed air	6 bar (87 PSI)
Dimensions	
Height of spindle center above floor	1100 mm (43.3")
Total machine height	1958 mm (77")
Foot print (without chip conveyor) L x D	2575 x 1790 mm (102" x 70")
Total weight	4000 kg (8818.4 lb)
Safety devices	
	CE conform



EN4560 - 02/17 - Subject to change due to technical progress. Errors and omissions excepted.

www.emco-world.com