

NMEA 2000 Network *Installation Instructions*

This instruction sheet covers the configuration and installation of a NMEA 2000 network.

HDS Units

If you have an HDS unit, you must make a one-time purchase of a NMEA 2000 Starter kit to create a NMEA 2000 network.

NMEA 2000 Starter kit (p/n: 000-0124-69)	
2-ft extension cable	120 ohm male terminator
15-ft extension cable	120 ohm female terminator
2 T connectors	Power node

Inline Terminator Cable

Some Lowrance LCX and LMS units and LGC-3000 antennas pack with an inline terminator cable — a cable with a 120 ohm terminator built into each end. You must discard the inline terminator cable and purchase a NMEA 2000 Starter Kit if you want to add more devices to that type of network.

Network Construction

To add a power node, display unit or device to a NMEA 2000 network, you **MUST** connect it to the bottom of a T connector as shown in the diagram on the right.

The top of a T connector can be connected to other T connectors, a terminator or to an extension cable that runs to other T connectors in a different part of the boat.

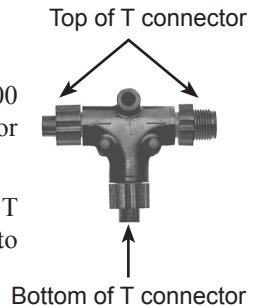

NMEA 2000 Network Components	
Nodes	T connector connected to a NMEA 2000 device
Terminators	Male and female 120 ohm terminators are connected to network at opposite ends of the NMEA 2000 backbone
Backbone	Consists of network cabling, T connectors and two 120 ohm terminators

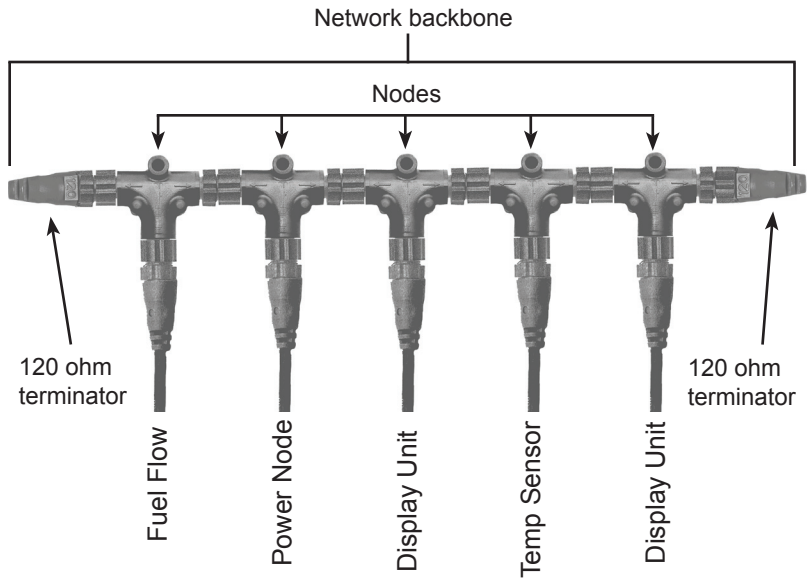

General NMEA 2000 Installation Rules

- Only devices/sensors should be connected to the bottom of a T connector; the connectors at the top of the T connector are only used for extension cables, terminators and other T connectors
- Power the Network only once
- A terminator must be connected to each end of the network backbone
- You can attach an extension cable between a device and the bottom of a T connector, but there should never be more than 18' (6 meters) of cable between a device and its T connector; likewise, the network — including drop lengths — should never be more than 200' (60 meters) long

Powering a NMEA 2000 Network

If you have an HDS unit, you **MUST** power the network with a power node.

If you have a LCX or LMS display unit, you can power the network with a power node or with your display unit. **It is very important to use only one of these methods for powering your network.**

Refer to your unit's operation manual to power the network with your display unit.

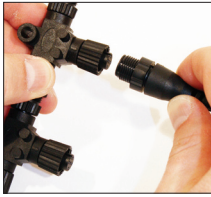

Plug the power node connector into the bottom of a T connector on the network

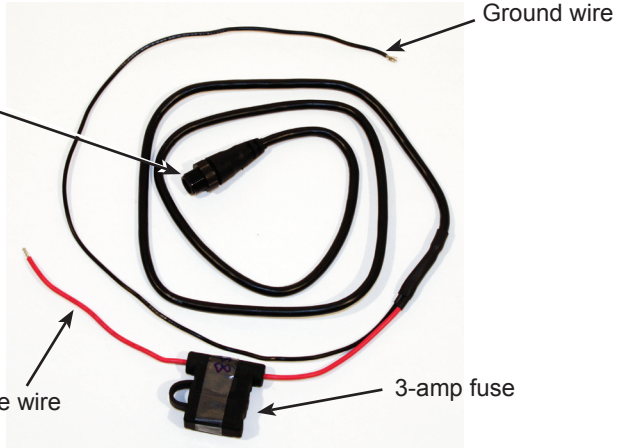

Power Node

To install a power node:

1. Connect the black (ground) wire to a ground.
2. Connect the Red (positive) wire to a switched 12-volt power source.
3. Plug the black power node connector into the bottom of a T connector on your NMEA 2000 network.

Adding Devices, a Network Node or Extension Cable

NMEA 2000 devices are added to a network by connecting the device to the bottom of a T connector. When adding additional devices to the network each device **MUST** have its own T connector on the network backbone.

You can add a node or extension cable to any existing connection, anywhere along the network backbone as long as each end of the backbone ends with a terminator.

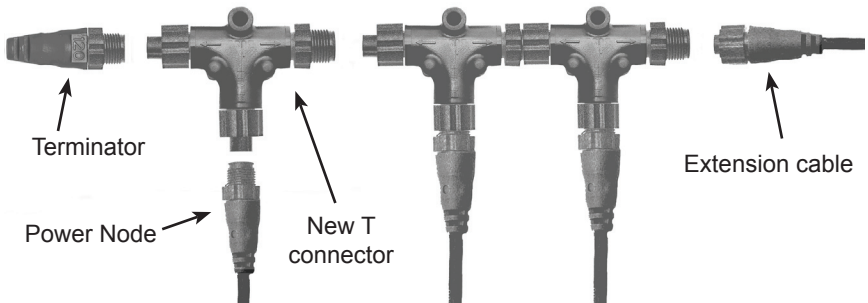

In this example, a power node is added to the network by installing a T connector between a T connector and a terminator. An extension cable connects these T connectors to T connectors in a different part of the boat.

Compatibility

NMEA 2000 Sonar/GPS combo units purchased in 2005 had Blue Style connectors. The Blue Style connectors can be used with NMEA 2000 Style connector display units and components with the purchase of an adapter cable.

NAC-FRD2FBL (P/N: 000-0127-05): connects NMEA 2000 Style connector devices to a Blue Style connector network.

NAC-MRD2MBL (P/N: 000-0127-04): connects Blue Style connector devices to a NMEA 2000 Style connector network.

NMEA 2000 Style connectors are compatible with Micro-C DeviceNet connector networks. NMEA 2000 devices WILL NOT work with NMEA 0183 devices.

Small boat example

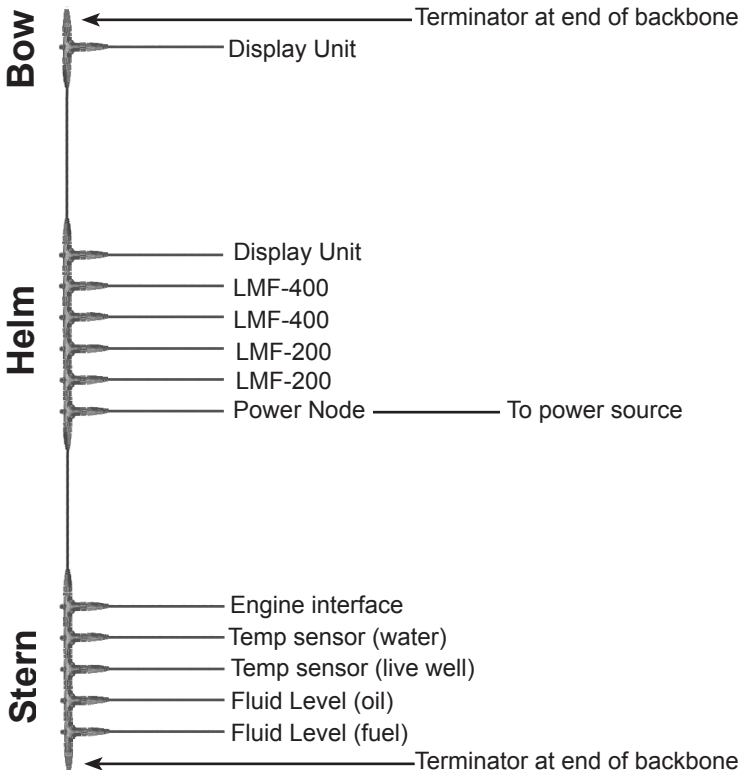

Large boat example

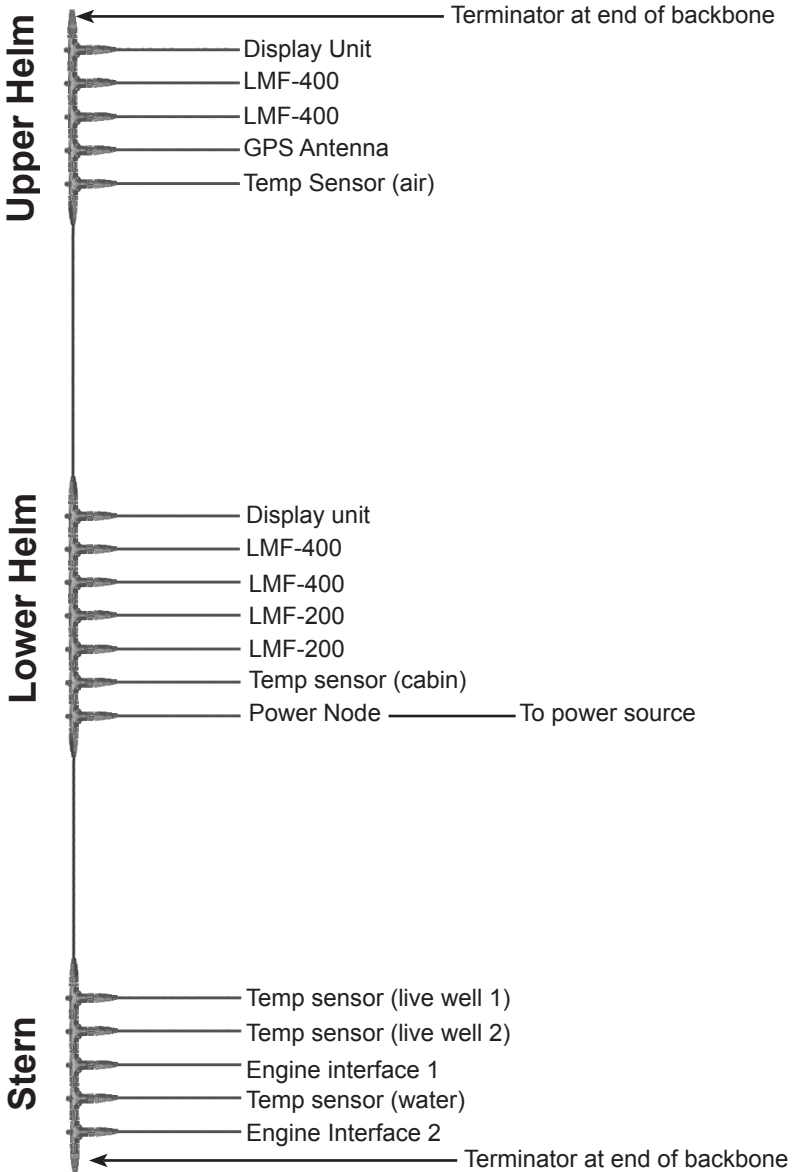

Blank Page

Blank Page

How to Obtain Service...

...in the USA:

Contact the Factory Customer Service Department. Call toll-free:

For Lowrance: 800-324-1356. For Eagle: 800-324-1354

8 a.m. to 5 p.m. Central Standard Time, M-F

Lowrance Electronics and Eagle Electronics may find it necessary to change or end their shipping policies, regulations and special offers at any time. They reserve the right to do so without notice.

...in Canada:

Contact the Factory Customer Service Department. Call toll-free:

800-661-3983

905-629-1614 (not toll-free)

8 a.m. to 5 p.m. Eastern Standard Time, M-F

...outside Canada and the USA:

Contact the dealer in the country where you purchased your unit. To locate a dealer near you, see the instructions in paragraph number 1 below.

Accessory Ordering Information

LEI Extras™, Inc. is the accessory source for sonar and GPS products manufactured by Lowrance Electronics and Eagle Electronics. To order Lowrance or Eagle accessories, please contact:

1) Your local marine dealer or consumer electronics store. To locate a Lowrance dealer, visit the web site, www.lowrance.com, and look for the Dealer Locator. To locate an Eagle dealer, visit the web site, www.eaglesonar.com, and look for the Dealer Locator. Or, consult your telephone directory for listings.

2) U.S. customers: LEI Extras Inc., PO Box 129, Catoosa, OK 74015-0129
Call toll free in the U.S., 800-324-0045, 8 a.m. to 5 p.m. Central Standard Time, M-F, or visit our web site www.lei-extras.com.

3) Canadian customers: Lowrance/Eagle Canada, 919 Matheson Blvd. E. Mississauga, Ontario L4W2R7 or fax 905-629-3118.

Call toll free in Canada, 800-661-3983, or dial 905 629-1614 (not toll free), 8 a.m. to 5 p.m. Eastern Standard Time, M-F.



© Copyright 2009
All Rights Reserved
Navico Holding AS