



Proximity Sensors

Inductive proximity sensors
Capacitive proximity sensors
Magnetic proximity sensors

Product family overview



Inductive proximity sensors

IM Miniature	C-32
M8, 3-wire	C-38
M8, 3-wire, short-body	C-46
M12, 2-wire	C-50
M12, 3-/4-wire	C-56
M12, 4-wire, multi-function	C-64
M18, 2-wire	C-70
M18, 3-/4-wire	C-76
M30, 2-wire	C-84
M30, 3-/4-wire	C-90

IM Triple	C-98
IMF Food & Beverage	C-110
IM Inox	C-118
IM Namur	C-124
IMA Analog	C-132
IH Miniature	C-142
IH Standard	C-148
IQ Miniature	C-156
IQ Flat	C-162

IQ10	C-168
IQ12	C-174
IQ40, short-body	C-180
IQ40	C-184
IQ80	C-190



Capacitive proximity sensors

CM	D-202
CM PTFE	D-210
CQ	D-214



Magnetic proximity sensors

MM	E-226
MM Namur	E-236
MQ	E-244

Accessories

Mounting systems	G-258
Magnets	G-266
Connection systems	G-267
Intrinsically safe Namur amplifier	G-280

Comprehensive and clearly arranged – The proximity sensor catalog in a nutshell



The appropriate technology

Chapter B

- General definition
- Selection table for the appropriate technology
- Defining different technologies (inductive, capacitive, magnetic)

Chapter H

- Glossary with additional explanations and abbreviations



The right product

Chapter C to chapter E

Detailed information about each product, including:

- Selection guides
- Product family overview
- Product description
- Your benefits
- Technical specifications
- Ordering information
- And much more ...

The matching accessories

Chapter G

- All accessories with dimensional drawings



Tailored solutions

Chapter F

Basic concepts
The basic concepts of proximity sensor technology... With the wide range of proximity sensors from SICK, choosing is always so easy at first glance. The material to be detected and the range are key selection criteria.

What technology for which material?

Object material to be detected	Proximity technology
Metals Steel, aluminum, brass, copper, etc.	Inductive
Liquids Water, acid, etc.	Capacitive
Bulk materials Powders, granules, etc.	Capacitive
Other solids Wood, paper, etc.	Capacitive
Magnets Permanent magnets, etc.	Magnetic

Theory and practice, standard and reality: When does the sensor detect?
The sensing range S_n of a proximity sensor is the distance at which a signal change is triggered when the target, i.e. the object to be detected, approaches the active surface axially.

Glossary
Act ... Etc

Active area
The active area of a proximity sensor is defined as the area covered by the sensing range. It is also the area over which the sensor responds to the approach of activated material through an output state change.

Adjustment indicators
The optical adjustment indicators enables fast adjustment of the sensors. The LED indicator flashes in the range 81% - 100% of the nominal sensing range and in continuous display over-flow when it reaches the secure sensing range (81%).

Switching output
LED lights up 0% 81% 100% 50%
Switching output

Ambient temperature, operation/storage

Inductive proximity sensors
Inductive proximity sensor sensing ranges at a glance

Series	0.5 m	1 m	2 m	4 m	10 m	20 m	30 m
IM Miniature	0.5 m	1 m	2 m	4 m	10 m	20 m	30 m
IM Triple	0.5 m	1 m	2 m	4 m	10 m	20 m	30 m
IMF Food & Beverage	0.5 m	1 m	2 m	4 m	10 m	20 m	30 m
IM Inox	0.5 m	1 m	2 m	4 m	10 m	20 m	30 m
IM Namur	0.5 m	1 m	2 m	4 m	10 m	20 m	30 m
IMA Analog	0.5 m	1 m	2 m	4 m	10 m	20 m	30 m
IH Miniature	0.5 m	1 m	2 m	4 m	10 m	20 m	30 m
IH Standard	0.5 m	1 m	2 m	4 m	10 m	20 m	30 m
IQ Miniature	0.5 m	1 m	2 m	4 m	10 m	20 m	30 m
IQ Flat	0.5 m	1 m	2 m	4 m	10 m	20 m	30 m
IQ10	0.5 m	1 m	2 m	4 m	10 m	20 m	30 m
IQ12	0.5 m	1 m	2 m	4 m	10 m	20 m	30 m
IQ40, short-body	0.5 m	1 m	2 m	4 m	10 m	20 m	30 m
IQ40	0.5 m	1 m	2 m	4 m	10 m	20 m	30 m
IQ80	0.5 m	1 m	2 m	4 m	10 m	20 m	30 m

Selection guides
Just a few steps to the right induction sensor

IM Miniature
Whether you're looking for a standard or a customized solution, the IM Miniature series offers you the right solution for your application.

Connection systems

Figure	Connector	Configuration	Jacket material	Cable length
1	Female connector M12, 4-pin, with 3 LEDs (P/NP)	Right angle	PVC	2 m, 5 m, 10 m
2	Female connector M12, 5-pin	Straight	PVC	2 m, 5 m, 10 m
3	Female connector M12, 5-pin, shielded	Straight	PUR halogen free	5 m, 10 m, 10 m
4	Female connector M12, 5-pin, shielded	Right angle	PVC	5 m, 10 m

Single-ended cordset dimensional drawings
DOL-0803-6xxM DOL-0803-6xx

Tailored solutions
Design to implementation of a tailored solution is divided into three areas and six phases. During each phase of the project, you can rely on our support and expertise – anywhere in the world.

Application analysis
SICK provides you with online assistance by providing you with a selection of tailored solutions.

Production and supply
SICK provides you with online assistance by providing you with a selection of tailored solutions.

Installation
SICK provides you with online assistance by providing you with a selection of tailored solutions.

Commissioning
SICK provides you with online assistance by providing you with a selection of tailored solutions.

my product
Customer requirement, Application expertise, Manufacturing expertise, Engineering expertise.



Navigation in the PDF document

By bookmarks and tables of contents

Bookmarks
General information
SICK
A
P

Table of contents
[A] About
[B] Det...

By page references

Additional information
Resistant to industrial cleaning agents, ECOLAB
and JohnsonDiversey
Certified
User etched part number
→ C-110

Links to www.mysick.com

By links, QR codes and part numbers

Part no.
6020145
6042085







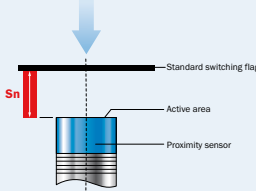

→ www.mysick.com/en/IM
For more information, just enter the part number, CAD design models, operating instructions...

SICK
Services & support
Buy now!

Literature
EC-Declaration of Conformity
Data sheet
Operating instructions
more...

Info service
Dimensional drawing
Connection type
Connection diagram
CAD Link

Related content
Accessories

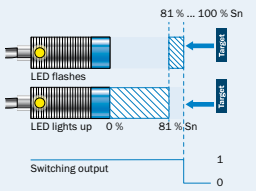
	<p>General information About SICK</p>	<p>A</p>
	 <p>Technology The right proximity sensor technology for your application – inductive, capacitive, magnetic</p>	<p>B</p>
	 <p>Inductive proximity sensors IM, IH, IQ</p>	<p>C</p>
	 <p>Capacitive proximity sensors CM, CQ</p>	<p>D</p>
	 <p>Magnetic proximity sensors MM, MQ</p>	<p>E</p>
	 <p>Tailored solutions</p>	<p>F</p>
	 <p>Accessories Connection systems, mounting system, other accessories</p>	<p>G</p>
	 <p>Appendix Glossary, index</p>	<p>H</p>

We deliver Sensor Intelligence.

SICK sensor solutions for industrial automation are the result of exceptional dedication and experience. From development all the way to service: The people at SICK are committed to investing all their expertise in providing with the very best sensors and system solutions possible.

A company with a culture of success

Approximately 5,000 people are on staff, with products and services available to help SICK sensor technology users increase their productivity and reduce their costs. Founded in 1946 and headquartered in Waldkirch, Germany, SICK is a global sensor specialist with more than 50 subsidiaries and representations worldwide. Our exemplary corporate culture

fosters an optimum work-life balance, thus attracting the best employees from all over the world. SICK is one of the best employers – we have been among the winners of the prestigious German “Great Place to Work” award for many years in succession.



Innovation for the leading edge

SICK sensor systems simplify and optimize processes and allow for sustainable production. SICK operates thirteen research and development centers all over the world. Co-designed with customers and universities, our innovative sensor products and solutions are made to give a decisive edge. With an impressive track record of innovation, we take the key parameters of modern production to new levels: reliable process control, safety of people and environmental protection.



A corporate culture for sustainable excellence

SICK is backed by a holistic, homogeneous corporate culture. We are an independent company. And our sensor technology is open to all system environments. The power of innovation has made SICK one of the technology and market leader – sensor technology that is successful in the long term.



A Sensor Intelligence for all requirements

SICK is a renowned expert in many industries, and is entirely familiar with the critical challenges they face. While speed, accuracy and availability take center stage in all industries, technical implementations vary greatly. SICK puts its vast experience to use to provide with precisely the solution you need.

For applications worldwide

Hundreds of thousands of installations and applications go to prove that SICK knows the different industries and their processes inside out. This tradition of uncompromising expertise is ongoing: As we move into the future, we will continue to design,

implement and optimize customized solutions in our application centers in Europe, Asia and North America. You can count on SICK as a reliable supplier and development partner.

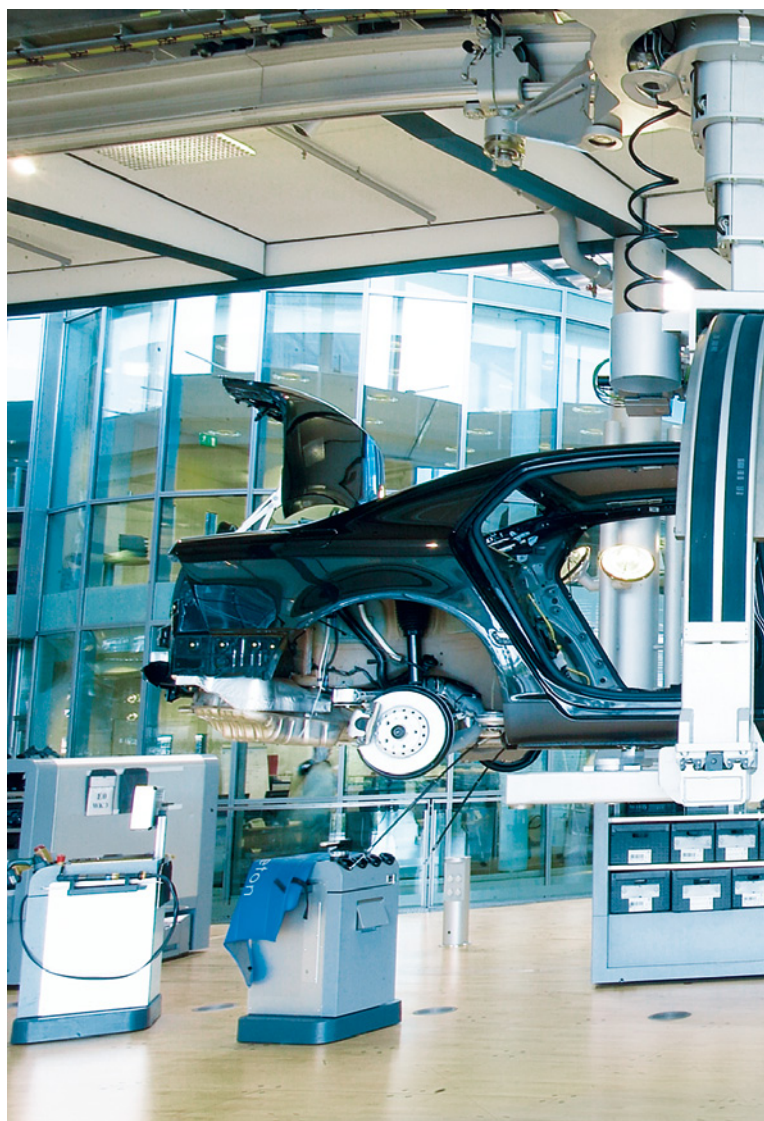
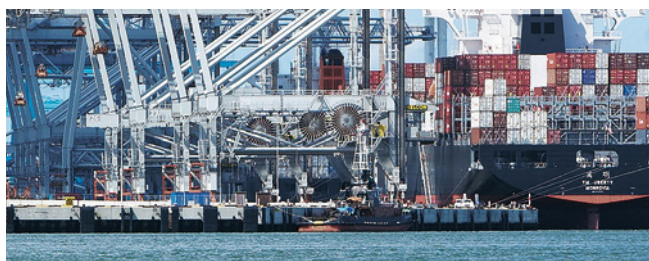

For your specific industry

With a track record of proven expertise in a great variety of industries, SICK has taken quality and productivity to new heights. The automotive, pharmaceutical, electronics and solar industries are just a few examples of sectors that benefit from our know-how. In addition to increasing speed and improving traceability in warehouses and distribution centers, SICK solutions provide accident protection for automated guided vehicles. SICK system solutions for analysis and flow measurement of gases and liquids enable environmental protection and sustainability in, for example, energy production, cement production or waste incineration plants.

For performance across the board

SICK provides the right technology to respond to the tasks involved in industrial automation: measuring, detecting, monitoring and controlling, protecting, networking and integrating, identifying, positioning. Our development and industry experts continually create groundbreaking innovation to solve these tasks.

 www.sick.com/Industries



A

For safety and productivity: SICK LifeTime Services

SICK LifeTime Services is a comprehensive set of high-quality services provided to support the entire life cycle of products and applications from system design all the way to upgrades. These services increase the safety of people, boost the productivity of machines and serve as the basis for our customers' sustainable business success.



Benefit from an array of services

Each of our products and solutions is accompanied by a comprehensive range of services tuned precisely to the requirements of the product or solution – along its entire life cycle. Backed by extensive industry know-how and more than sixty

years of experience, LifeTime Services stand for maximum availability and an exceptional service life of our products and solutions.





Training & Education

- User training
- Seminars
- WebTraining



Product & System Support

- Commissioning
- Spare parts and repairs
- Remote support
- Hotline



Verification & Optimization

- Barcode checks
- Consulting/Engineering service
- Inspection
- Maintenance
- Accident analysis
- Stop time measurement
- Noise measurement



Consulting & Design

- System inspection
- Risk assessment
- Safety concepts
- Feasibility studies
- Software and hardware design



Upgrade & Retrofits

- Machine conversion
- Sensor upgrades
- Sensor replacements
- Retrofitting of technology



www.sick.com/service



A Versatile product range for industrial automation

From the simple acquisition task to the key sensor technology in a complex production process: with every product from its broad portfolio, SICK offers a sensor solution that best combines cost effectiveness and safety.

 www.sick.com/products

Photoelectric sensors



- Miniature photoelectric sensors
- Small photoelectric sensors
- Compact photoelectric sensors
- Fiber-optic sensors and fibers
- Cylindrical photoelectric sensors
- Zone control

Proximity sensors



- Inductive proximity sensors
- Capacitive proximity sensors
- Magnetic proximity sensors

Magnetic cylinder sensors



- Analog position sensors
- Sensors for T-slot cylinders
- Sensors for C-slot cylinders
- Sensor adapters for other cylinder types

Identification solutions



- Bar code scanners
- Image-based code readers
- Hand-held scanners
- RFID

Detection and ranging solutions



- Laser measurement technology

System solutions



- Volume measurement systems
- Code reading systems
- Dimension weighing scanning systems

Fluid sensors



- Level sensors
- Pressure sensors
- Flow sensors
- Temperature sensors

Registration sensors



- Contrast sensors
- Color sensors
- Luminescence sensors
- Fork sensors
- Array sensors

Distance sensors



- Short range distance sensors (displacement)
- Mid range distance sensors
- Long range distance sensors
- Linear measurement sensors
- Ultrasonic sensors
- Double sheet detector
- Optical data transmission
- Position finders

A

Automation light grids



- Advanced automation light grids
- Standard automation light grids
- Smart light grids

Vision



- Vision sensors
- Smart cameras
- 3D cameras
- Vision systems

Opto-electronic protective devices



- Safety laser scanners
- Safety camera systems
- Safety light curtains
- Multiple light beam safety devices
- Single-beam photoelectric safety switches
- Mirror and device columns
- Upgrade kits

Safety switches



- Electro-mechanical safety switches
- Non-contact safety switches
- Safety command devices

sens:Control – safe control solutions



- Safety relays
- Safety controllers
- Network solutions

Motor feedback systems



- Interfaces: incremental, HIPERFACE® and HIPERFACE DSL®
- Safety motor feedback systems
- Rotary and linear motor feedback systems for asynchronous, synchronous motors and linear motors

Encoders

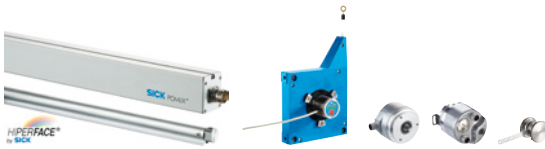

- Rotary incremental encoders
- Rotary absolute encoders
- Wire draw encoders
- Absolute linear encoders

Analyzers and systems



- Gas analyzers
- Dust measuring devices
- Analyzer systems
- Liquid analyzers
- Data acquisition systems
- Tunnel sensors

Gas flow measuring devices



- Gas flow meters
- Mass flow meters
- Volume flow meters



Within reach – and still no contact

Objects sometimes appear closer than they are. The proximity sensors from SICK, however, are not fooled when detecting objects. They detect objects with the utmost precision. The material from which the approaching object is made of has nearly no effect on the accuracy of the sensors. Whether metal or other solid materials such as wood or paper, liquids, granules or permanent magnets, the solution for your application is within reach with proximity sensors from SICK.



A selection guide for the right **proximity sensor technology** can be found on page B-17.

Inductive proximity sensors

For non-contact detection of metal objects

Information about the technology of **inductive proximity sensors** can be found on page B-18.



B

Capacitive proximity sensors

For non-contact detection of virtually all materials – even behind a wall or in packaging

Information about the technology of **capacitive proximity sensors** can be found on page B-20.



Magnetic proximity sensors

For non-contact detection of permanent magnets

Information about the technology of **magnetic proximity sensors** can be found on page B-21.













The basic concepts of proximity sensor technologies

With the wide range of proximity sensors from SICK, choosing the right sensor is not always so easy at first glance. The material to be detected and the required sensing range are key selection criteria.

B

What technology for which material?

Object material to be detected		Proximity sensor technologies	From page	
Metals Steel, aluminum, brass, copper, etc.			Inductive	B-18
Liquids Water, acid, etc.			Capacitive	B-19
Bulk materials Powders, granules, etc.			Capacitive	B-19
Other solids Wood, paper, etc.			Capacitive	B-19
Magnets Permanent magnets, etc.			Magnetic	B-21

Theory and practice, standard and reality: When does the sensing range change?

The sensing range S_n of a proximity sensor is the distance at which a signal change is triggered when the target, i.e., the object to be detected, approaches the active surface axially. The **standard target** has been defined to obtain comparable values in the proximity sensors for the sensing distance. In the technical data of the proximity sensors from SICK, this value is always specified.

The standard target is defined as follows

	Inductive/capacitive	Magnetic
Material	St37 (steel)	Oxide magnet
Dimension	1 mm thick (square)	Ø 30 mm x 10 mm high (M4.0, round)
	Side length = Active area diameter or $3 \times S_n$ ¹⁾	

¹⁾ The larger of the two values indicates the side length of the standard target.

Example calculation of the side length of a standard target (inductive/capacitive):

Active area diameter	12 mm
Nominal Sensing Range S_n	6 mm
	► $3 \times S_n = 3 \times 6 \text{ mm} = 18 \text{ mm}$
► The side length of the standard target is 18 mm .	

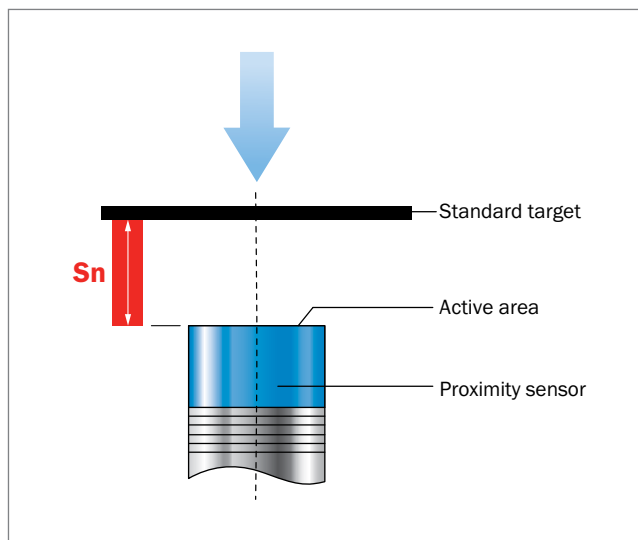

A reduction in the target always results in a reduction in the sensing range.

Standardized ratios are the theory. In practice, there are deviations that affect the sensing range.

The sensing range S_n specified in the technical data does not account for external influences or sample variances and therefore, is only a conventional value.

Depending on the selected sensor principle, different tolerance ranges are possible. As a result the actual measured sensing range of the sensors can vary.

Tolerance ranges

Inductive and magnetic proximity sensors
 ▶ $0.81 \times S_n < \text{tolerance range} < 1.21 \times S_n$

Capacitive proximity sensors
 ▶ $0.72 \times S_n < \text{tolerance range} < 1.32 \times S_n$

In practice, the **assured sensing range S_a** is always used when designing a sensor to ensure switching in consideration of all tolerance influences and to operate the sensor in a secure work area.

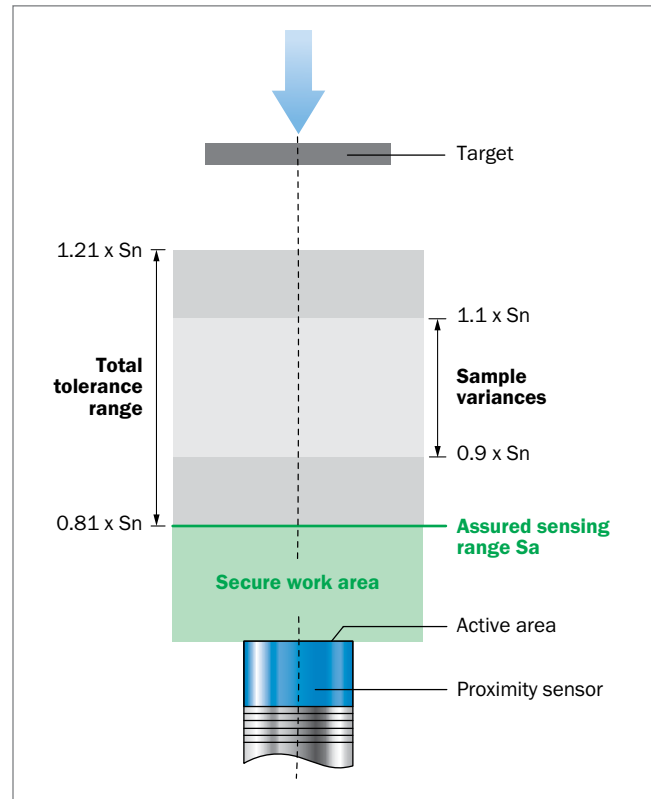

B



Assured sensing range S_a

The distance at which a response from the proximity switch is ensured under the specified temperature, installation and voltage conditions.

Formula for calculating the assured sensing range S_a

Inductive and magnetic proximity sensors
 ▶ $S_a = 0.81 \times S_n$

Capacitive proximity sensors
 ▶ $S_a = 0.72 \times S_n$

Example calculation of the assured sensing range for inductive and magnetic proximity sensors:

Sensing range $S_n = 20 \text{ mm}$

$S_a = 0.81 \times S_n = 0.81 \times 20 \text{ mm} = 16.2 \text{ mm}$

▶ The assured sensing range S_a is 16.2 mm.

Example calculation of the assured sensing range for capacitive proximity sensors:

Sensing range $S_n = 10 \text{ mm}$

$S_a = 0.72 \times S_n = 0.72 \times 10 \text{ mm} = 7.2 \text{ mm}$

▶ The assured sensing range S_a is 7.2 mm.



Selection guides for the **sensing range S_n** can be found in the respective product chapters C, D and E.

The reduction factor (R_m)

As described, the sensing range S_n used in the technical data always refers to the standard target, i.e., metallic material made of ST37 (steel) or oxide magnet M4.0. If an object is detected from another material, the sensing range is reduced. The reduction is expressed with the reduction factor (R_m). Therefore, additional standard values for the reduction factor are specified in the technical data.

B

Typical materials and their reduction factors

Inductive

Material	Reduction factor R_m
Steel (ST37)	1
Stainless steel	0.65 - 0.9 ¹⁾
Aluminum	0.2 - 0.5 ¹⁾

¹⁾ Depending on the sensor.

Capacitive

Material	Reduction factor R_m
Water	1
PVC	0.4
Oil	0.25

Magnetic

Magnet	Reduction factor R_m
M5.0	1.1 - 1.2 ¹⁾
M4.0	1
M1.0	0.25 - 0.38 ¹⁾

¹⁾ Depending on the sensor.

Example calculation of the assured sensing range for inductive and magnetic proximity sensors:

Material	Aluminum ($R_m = 0.5$)
Nominal Sensing Range S_n	20 mm
$S_a = 0.81 \times S_n = 0.81 \times 20 \text{ mm} = 16.2 \text{ mm}$	
Assured sensing range = $R_m \times S_a = 0.5 \times 16.2 \text{ mm} = 8.1 \text{ mm}$	
► The assured sensing range is 8.1 mm.	

Example calculation of the assured sensing range for capacitive proximity sensors:

Material	PVC ($R_m = 0.4$)
Nominal Sensing Range S_n	10 mm
$S_a = 0.72 \times S_n = 0.72 \times 10 \text{ mm} = 7.2 \text{ mm}$	
Assured sensing range = $R_m \times S_a = 0.4 \times 7.2 \text{ mm} = 2.88 \text{ mm}$	
► The assured sensing range is 2.88 mm.	

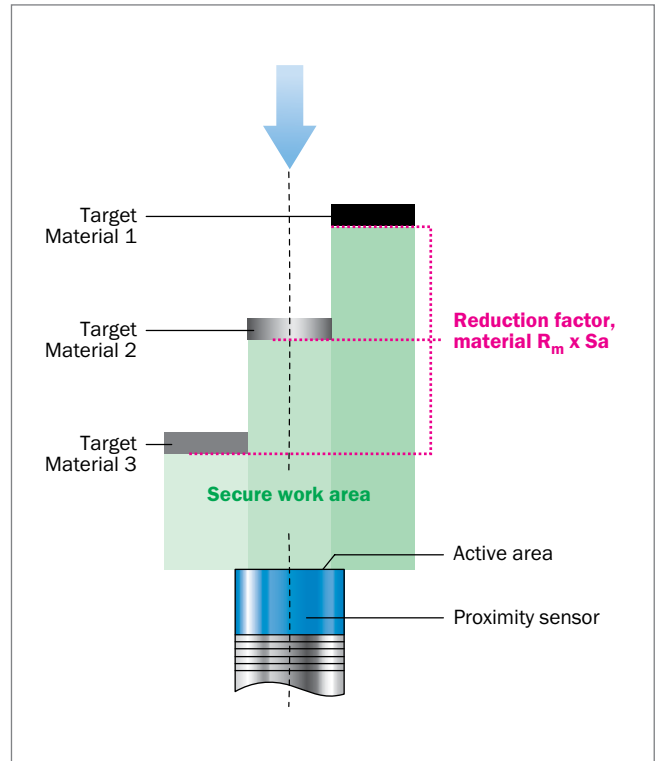

More definitions for the proximity sensor technologies can be found in Chapter H (Appendix/Glossary).

The right proximity sensor for your application

	Inductive proximity sensors												Capacitive proximity sensors			Magnetic proximity sensors		
	IM Miniature	IM Standard	IM Triple	IMF Food & Beverage	IM Inox	IM Namur	IMA Analog	IH Miniature	IH Standard	IQ Miniature	IQ Flat	IQ Standard	CM	CM PTFE	CQ	MM	MM Namur	MQ
What material should be detected?																		
Metal	■	■	■	■	■	■	■	■	■	■	■	■						
Powders, granules, liquid, solid													■	■	■			
Magnet																■	■	■
What sensing range S_n is required?																		
0 ... 1 mm	■							■			■							
1 ... 2 mm	■	■				■			■			■						
2 ... 4 mm		■	■	■		■	■		■	■	■	■						
4 ... 8 mm		■	■	■	■	■	■					■	■					
8 ... 10 mm		■	■	■	■	■	■					■	■	■				
10 ... 20 mm		■	■	■	■	■	■		■			■	■		■			
20 ... 40 mm			■		■		■		■			■	■		■			
40 ... 60 mm												■						
60 ... 120 mm																■	■	■
Which design is required?																		
Cylindrical threaded	■	■	■	■	■	■	■					■	■		■	■		
Cylindrical smooth								■	■									
Rectangular										■	■	■			■			■
Are there any special requirements for the sensor?																		
Use in the "food & beverage" industry				■	■								■					
Use in potentially explosive environments						■											■	
High mechanical stress					■													
Should the sensor have other special features?																		
Analog output							■											
All metal sensors					■													
Sensors with triple sensing range			■		■													
From page	C-32	C-38	C-98	C-110	C-118	C-124	C-132	C-142	C-148	C-156	C-162	C-168	D-202	D-210	D-214	E-226	E-236	E-244
Detailed selection guide	C-26												D-198			E-222		

B



SICK can also offer **customized solutions**.
You can find more information in Chapter F.

The basic concepts of inductive proximity sensor technology

An inductive proximity sensor detects metallic objects without making contact with the object. It consists of a switching amplifier, a signal evaluator and an LC circuit, i.e., resonant electric circuit comprising a coil (L) and a capacitor (C).

B

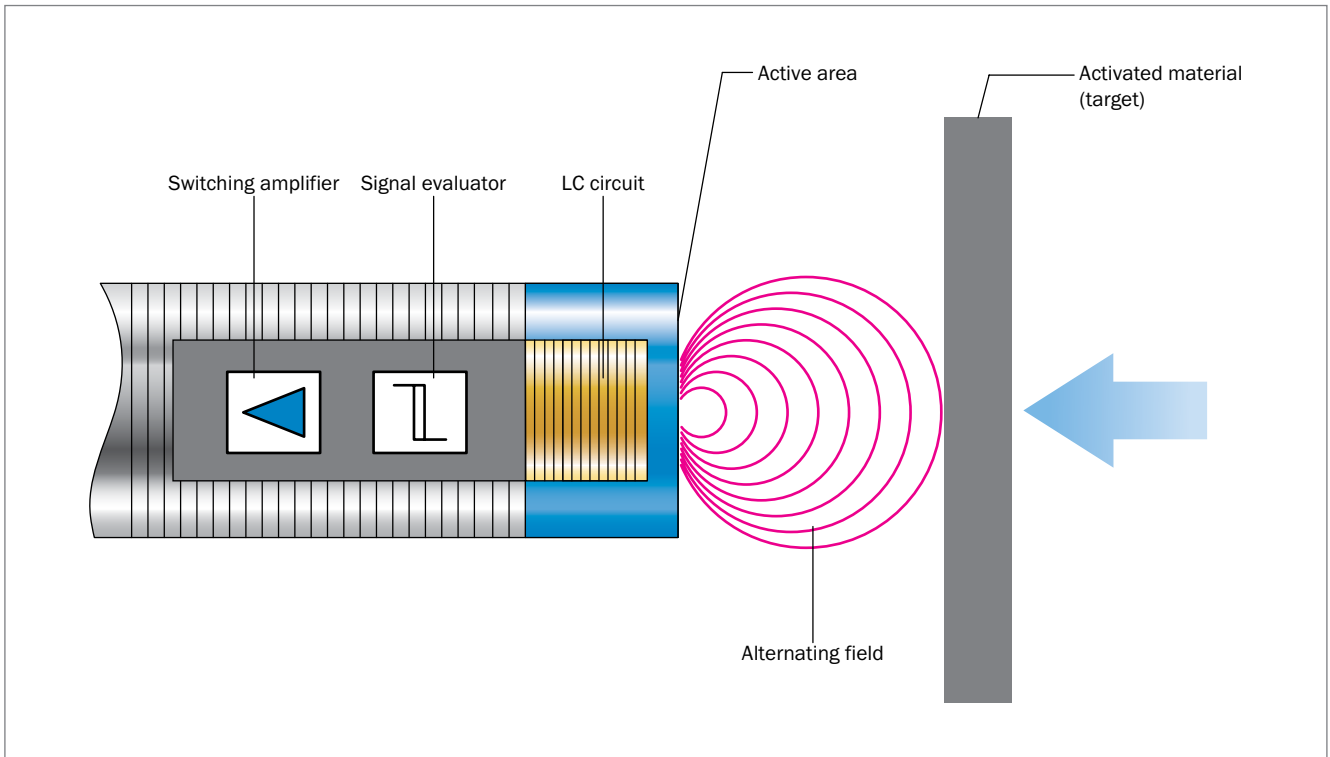

Inductive proximity sensors can take two output states, which are described as activated and deactivated. To detect metallic objects, the coil of the resonant circuit generates a high frequency electromagnetic alternating field that emerges from the active area of the sensor. The size of the field is defined by the size of the ferrite core and the coil.

If an activated material approaches the active surface, non-ferrous metal eddy currents are generated. In ferromagnetic metals there are additional core losses. These losses deprive the resonant circuit of energy and dampen the oscillation. The signal evaluator detects this change and translates this into a switching signal.



Selection guides for **inductive proximity sensors** can be found in product chapter C from page C-26.

The basic concepts of capacitive proximity sensor technology

For capacitive proximity sensors, the principle of an open capacitor is used. The sensor contains an active electrode from which an electrostatic field to earth (ground potential) develops. This capacitance is part of a resonant circuit and affects the fundamental vibration behavior.

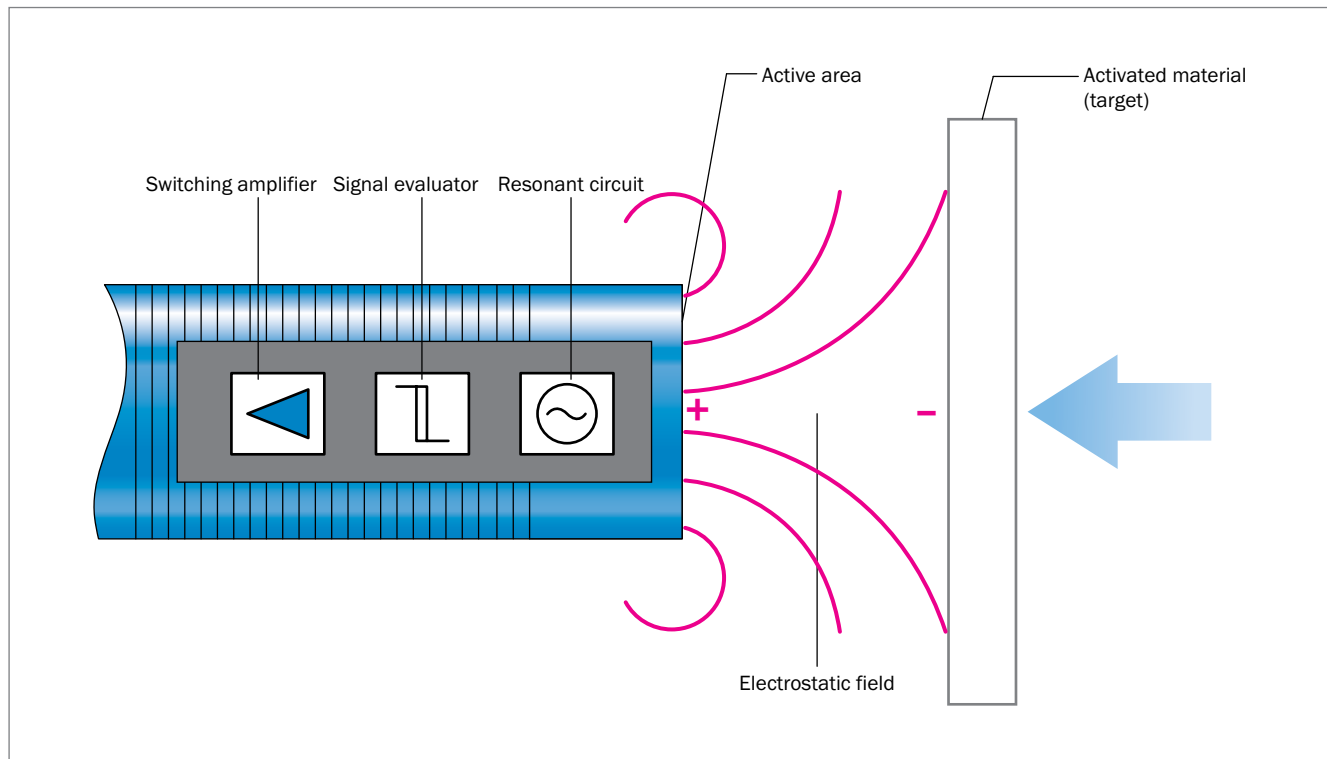

B

If an object/medium finds itself in the electrical field, the vibration behavior of the resonant circuit changes (based on its dielectric properties) and there is a change in amplitude. The signal evaluator detects this change in amplitude and the switching amplifier signals to switch. The closer the object comes to the active electrode, the greater the change in capacitance. The capacitance is influenced by the following factors:

ϵ_r = Dielectric permittivity of the object/medium

A = Electrode area

d = Distance between the electrodes

Capacitance (C) can be described using the following formula:

$$C = \epsilon_r \times \frac{A}{d}$$

The greater ϵ_r or A and the smaller d, the greater the capacitance or the detectable change in capacitance. The sensitivity can also be adjusted by means of potentiometer, Teach-in button or wire (external teach).

Overview of the dielectric permittivities (ϵ_r) of typical materials and media

Material	Dielectric permittivity ϵ_r	Reduction factor R_m
Metal	80	1
Water	80	1
Alcohol	30	0.7
Glass	8	0.6
Ceramics	7	0.5

Material	Dielectric permittivity ϵ_r	Reduction factor R_m
PVC	6	0.4
Ice	5	0.35
Oil	2	0.25
Air (vacuum)	1	0

B

Special features of capacitive sensors

Detection through material

Wall thicknesses of 10 to 20 mm in the case of plastic or glass containers.

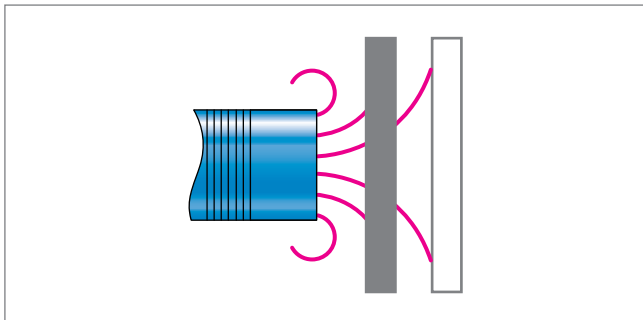

Tough/rough ambient conditions

Highly resistant to vibrations, dust, dirt, etc.

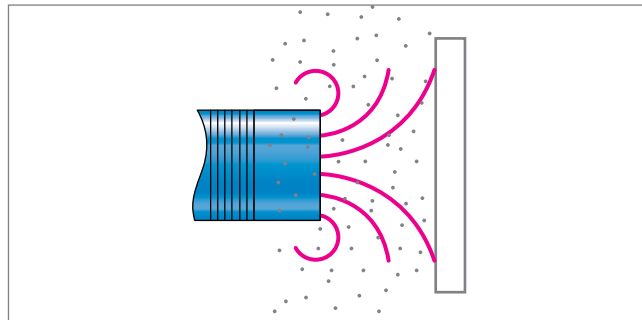

Detection of all materials

Wood, paper, metal, plastic, liquids, granules.

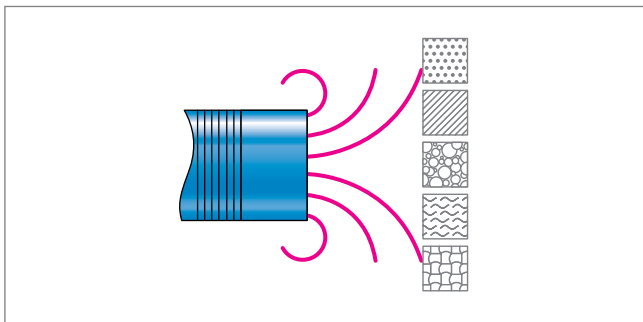

Relatively large sensing ranges with a compact design

Up to $S_n = 25$ mm (CM30/CQ35).

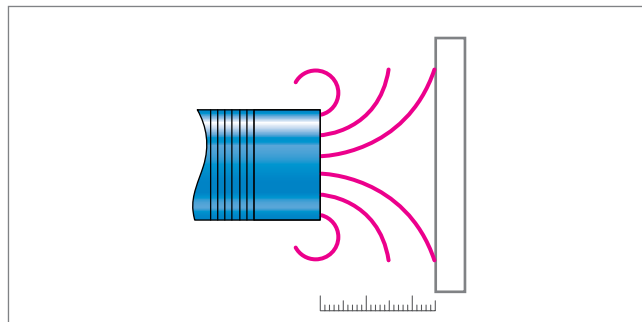

High electromagnetic and electrostatic compatibility

Thanks to Tripleshield technology.

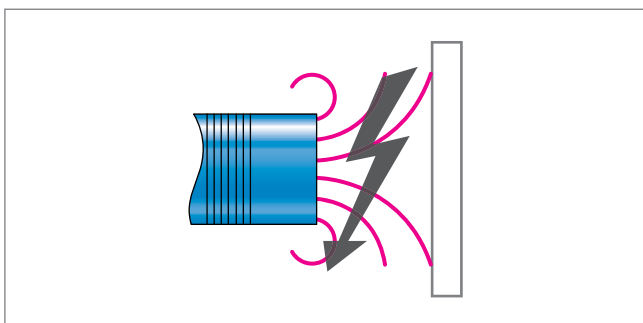

Selection guides for [capacitive proximity sensors](#) can be found in product chapter D from page D-198.

The basic concepts of magnetic proximity sensor technology

Magnetic proximity sensors always respond to a magnet (magnetic encoder). Magnetic fields penetrate all non-magnetic materials, e.g., non-ferrous metal, plastic or wooden walls. Therefore, magnets can also detect through these walls without affecting the sensing range.

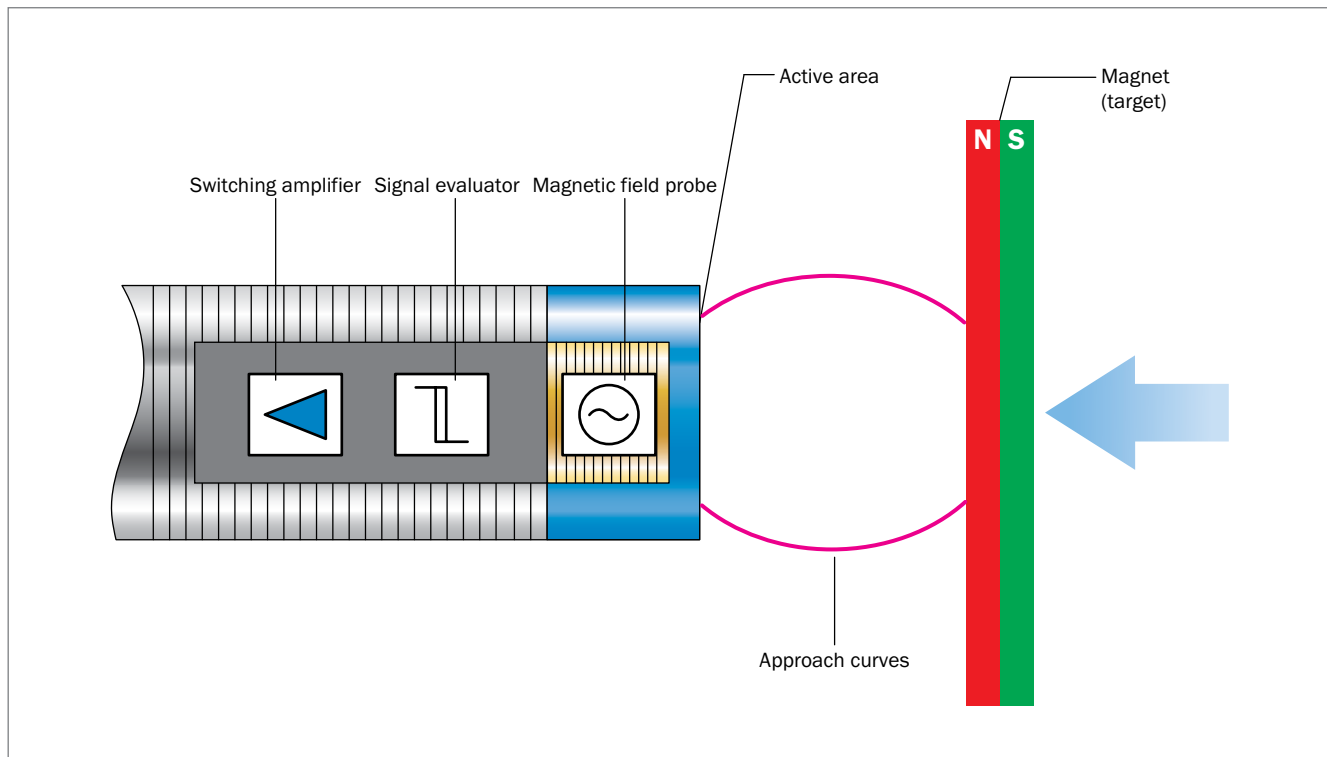

B

For the magnetic proximity sensors from SICK, two detection technologies are used.

GMR technology (Giant Magneto Resistive effect)

Resistors that change their ohmic value by magnetic fields are arranged in a Wheatstone bridge. When exposed to a magnetic field, the bridge voltage increases. The signal evaluator generates an output signal from a defined threshold.

LC circuit technology

An LC circuit is pre-activated from a highly permeable, amorphous glass metal strip. It resonates with a small amplitude. If an external magnetic field appears, the highly permeable (highly magnetically conductive) glass metal strip reaches saturation. Activation of the LC circuit by the glass metal strip no longer occurs. The amplitude of the resonant circuit increases whereby a defined threshold is reached and an output signal generated.

This technology is well suited for high sensing ranges (Sn > 70 mm with M4.0 magnet).

Approach curves

When using magnetic proximity sensors, make sure that the alignment of the magnet relative to the sensor axis changes the sensing range. A distinction is made between the following cases:

Sensor and magnet axis are in the same plane to each other

Case 1

The sensor responds when the magnet reaches the switch curve. It can approach the proximity sensor axially or pass within the sensing range in front of the sensor.

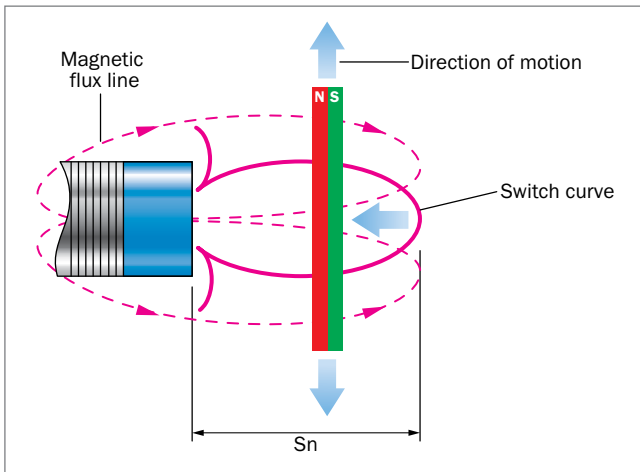

Case 2

The sensor responds when the magnet reaches the switch curve from the side. If the magnet leaves the switch curve, the sensor switches back again.

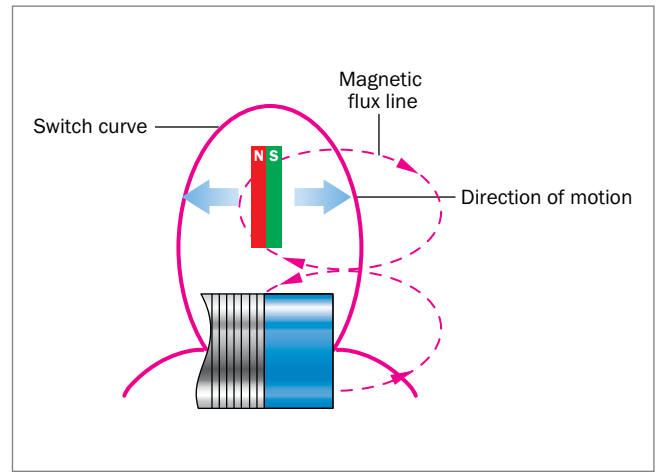

Sensor and magnet axis are offset by 90°

Case 3

If the magnet passes in front of the proximity sensor radially, the sensing range is less than in case 1. If the magnet travels into the left switch curve from the right switch curve, for example, it passes through an area in which the magnetic field is reversed. The proximity sensor is briefly deactivated before it is activated again in the left switch curve. Whether the evaluation unit can detect this interruption depends on the speed of travel and the axial distance of the passing magnet.

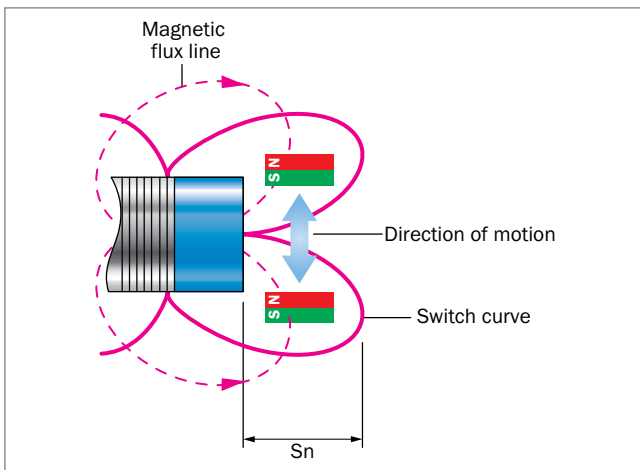

Case 4

The magnet also passes through two switch curves. At the boundary, the magnetic field is reversed and there are two switching points. The solubility of this interruption also depends on the speed of travel and the radial distance to the sensor axis.

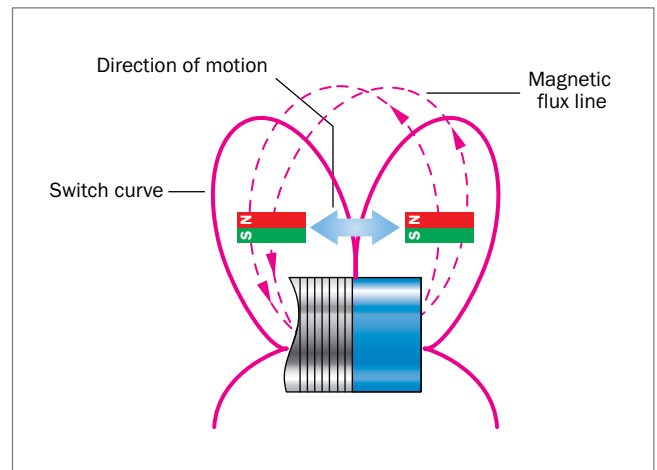

Overrun distance $S_{\ddot{u}}$

The overrun distance $S_{\ddot{u}}$ consists of the path of the switch curve and the diameter of the magnet. If a magnet approaches the switch curve from the left, the sensor responds. If the magnet exits the switch curve on the opposite side, the sensor only switches when the magnet has left the switch curve entirely.

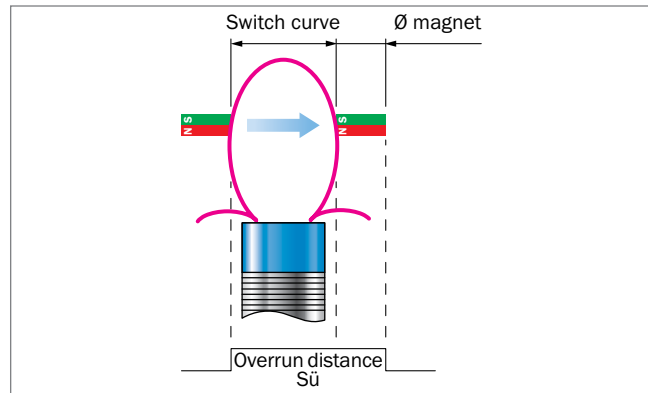

B

Installation notes

Flush sensor installation

Magnetic proximity sensors can be installed flush in all materials and metals without affecting the sensing range with the exception of magnetizable materials.

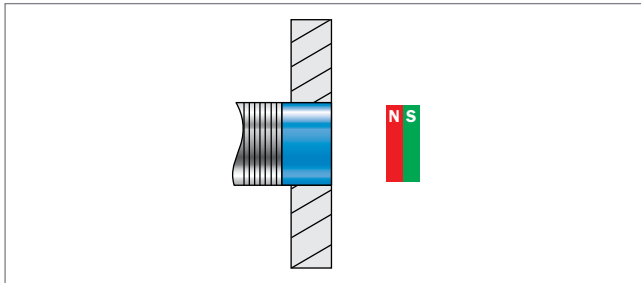

Non-flush sensor installation

The table shows how much the proximity sensor must protrude when installed in magnetic materials to prevent a reduction in the sensing range by more than 5%. Measurement standard MAG-3010-B (M 4.0).

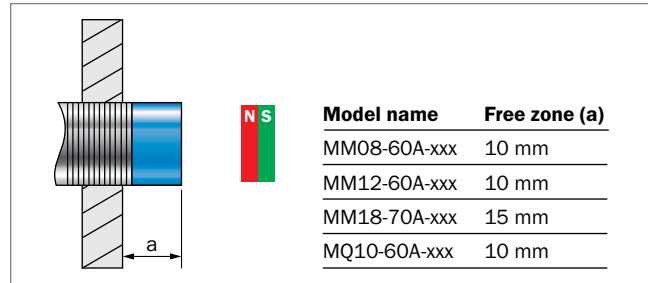

Flush magnet installation

For flush installation of the magnets in magnetic materials, the sensing range is reduced by up to 60%.

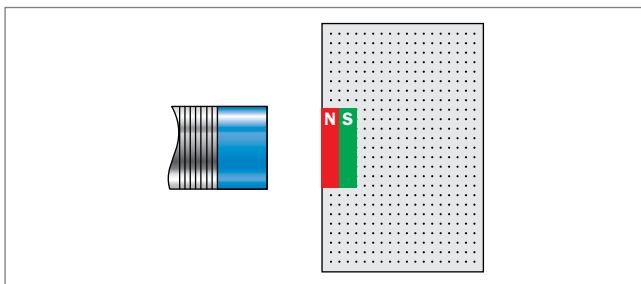

Penetration through materials

Because magnetic fields penetrate all non-magnetic materials, magnetic proximity sensors can detect objects/media behind non-ferrous metal, plastic or wooden walls, for example.

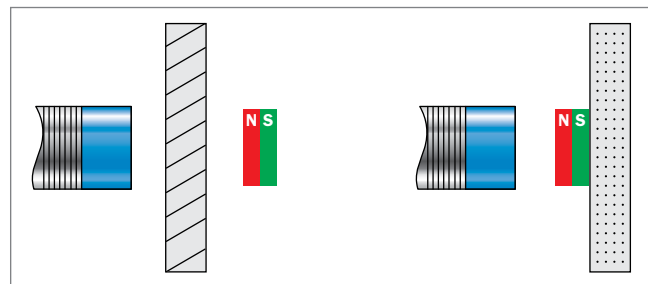

Selection guides for **magnetic proximity sensors** can be found in product chapter E from page E-222.

SICK SICK

SICK SICK

Reliable, powerful, rugged – Inductive sensors from SICK













Millions of inductive sensors are currently in use in virtually all industries. They detect metal objects without contact, and are characterized by a long service life and extreme ruggedness. With the latest ASIC technology, SICK's sensors offer the ultimate in precision and reliability. SICK can provide the right solution to meet your requirements every time – from cylindrical or rectangular standard sensors with single, double or triple sensing range, to special sensors for explosive zones and harsh environments. Our sensors are the intelligent, reliable route for implementing industry-specific and customized solutions in any task involving automation.





C

Inductive proximity sensors

Selection guides C-26	
Product family overview C-28	
 IM Miniature C-32 Space-saving miniature threaded sensors	 IMA Analog C-132 Analog inductive sensors with triple sensing range
 IM Standard C-38 M8, 3-wire C-38 M18, 2-wire C-70 M12, 2-wire C-50 M18, 3-/4-wire .. C-76 M12, 3-/4-wire .. C-56 M30, 2-wire C-84 M30, 3-/4-wire .. C-90	 IH Miniature C-142 Space-saving miniature smooth inductive sensors
 IM Triple C-98 Inductive sensors with triple the sensing distance	 IH Standard C-148 Smooth cylindrical housing for time-saving installations
 IMF Food & Beverage C-110 Inductive sensors for wash down environments	 IQ Miniature C-156 Rectangular, small and space-saving
 IM Inox C-118 Single-piece stainless steel sensors for the highest demands	 IQ Flat C-162 Low profile sensors when space is at a premium
 IM Namur C-124 Namur sensors for explosive zones	 IQ Standard C-168 IQ10. C-168 IQ40. C-180 IQ12. C-174 IQ80. C-190

Just a few steps to the right inductive proximity sensor

C

	IM Miniature	IM Standard	IM Triple	IMF Food & Beverage	IM Inox	IM Namur	IMA Analog	IH Miniature	IH Standard	IQ Miniature	IQ Flat	IQ Standard
Which design is required?												
Cylindrical threaded	■	■	■	■	■	■	■					
Cylindrical smooth								■	■			
Rectangular										■	■	■
What size is required?												
M4	■											
M5	■											
M8		■	■			■	■					
M12		■	■	■	■	■	■					
M18		■	■	■	■	■	■					
M30			■		■	■	■					
Diameter ≤ 4 mm								■				
Diameter 6.5 mm ... 34 mm									■			
Rectangular (for detailed dimensions, see page C-156)										■	■	■
What maximum sensing range is required?												
≤ 1 mm	■							■		■		
≤ 2 mm	■	■				■			■	■	■	
≤ 4 mm		■	■	■		■	■		■	■	■	■
≤ 8 mm		■	■	■	■	■	■				■	■
≤ 10 mm		■	■	■	■	■						■
≤ 20 mm		■	■	■	■	■	■		■			■
≤ 40 mm			■		■		■		■			■
≤ 60 mm												■
What switching output is required?												
DC 2-wire		■										■
DC 3-wire	■	■	■	■	■			■	■	■	■	■
DC 4-wire		■		■							■	■
AC 2-wire		■										■
AC/DC 2-wire		■							■			■
Analog							■					
Namur						■						
What housing material should the sensor have?												
Plastic									■	■	■	■
Nickel-plated brass		■	■			■	■			■		
Stainless steel V2A	■							■	■			
Stainless steel V4A				■	■							
Are there any special requirements for the sensor?												
Use in the "food & beverage" industry				■	■							
All metal sensors					■							
Use in potentially explosive environments						■						
From page	C-32	C-38	C-98	C-110	C-118	C-124	C-132	C-142	C-148	C-156	C-162	C-168





SICK can also offer customized solutions. You can find more information in chapter F.

Inductive proximity sensor sensing ranges at a glance





Product family	Max. sensing range (mm) ¹⁾															Page		
	0.4	0.6	0.8	1	2	4	6	8	10	12	16	20	30	40	60			
IM Miniature																		
M04	0 mm ... 0.6 mm																C-32	
M05	0 mm ... 1.5 mm																C-32	
IM Standard																		
M8, 3-wire	0 mm ... 4 mm																C-38	
M8, 3-wire, ultrashort	0 mm ... 1.5 mm																C-46	
M12, 2-wire	0 mm ... 4 mm																C-50	
M12, 3-/4-wire	0 mm ... 8 mm																C-56	
M12 multitalents	0 mm ... 4 mm																C-64	
M18, 2-wire	0 mm ... 12 mm																C-70	
M18, 3-/4-wire	0 mm ... 12 mm																C-76	
M30, 2-wire	0 mm ... 15 mm																C-84	
M30, 3-/4-wire	0 mm ... 20 mm																C-90	
IM Triple																		
IM08	0 mm ... 6 mm																C-98	
IM12	0 mm ... 10 mm																C-98	
IM18	0 mm ... 20 mm																C-98	
IM30	0 mm ... 40 mm																C-98	
IMF Food & Beverage																		
M12	0 mm ... 8 mm																C-110	
M18	0 mm ... 12 mm																C-110	
IM Inox																		
M12	0 mm ... 10 mm																C-118	
M18	0 mm ... 20 mm																C-118	
M30	0 mm ... 40 mm																C-118	
IM Namur																		
M08	0 mm ... 1 mm																C-124	
M12	0 mm ... 4 mm																C-124	
M18	0 mm ... 8 mm																C-124	
M30	0 mm ... 15 mm																C-124	
IMA Analog																		
M08	0 mm ... 4 mm																C-132	
M12	0 mm ... 6 mm																C-132	
M18	0 mm ... 20 mm																C-132	
M30	0 mm ... 40 mm																C-132	
IH Miniature																		
IH03	0 mm ... 0.6 mm																C-142	
IH04	0 mm ... 0.8 mm																C-142	
IH Standard																		
IH06	0 mm ... 4 mm																C-148	
IH20	0 mm ... 10 mm																C-148	
IH34	0 mm ... 30 mm																C-148	
IQ Miniature																		
IQ05	0 mm ... 0.8 mm																C-156	
IQ08	0 mm ... 4 mm																C-156	
IQ Flat																		
IQ04	0 mm ... 1.5 mm																C-162	
IQ06	0 mm ... 3 mm																C-162	
IQ20	0 mm ... 7 mm																C-162	
IQ25	0 mm ... 5 mm																C-162	
IQ Standard																		
IQ10	0 mm ... 6 mm																C-168	
IQ12	0 mm ... 8 mm																C-174	
IQ40	0 mm ... 40 mm																C-180	
IQ80	0 mm ... 60 mm																	C-190

¹⁾ The maximum sensing range depends on the type of installation. For detailed information, see the product detail pages in Chapter C.





Product family overview

	 <p style="text-align: center;">IM Miniature</p>	 <p style="text-align: center;">IM Standard</p>	 <p style="text-align: center;">IM Triple</p>	
	<p>Space-saving miniature threaded inductive sensors</p>	<p>The industry standard for inductive sensors</p>	<p>Inductive sensors with triple the sensing range</p>	
<p>Technical data overview</p>				
<p>Housing</p>	<p>Cylindrical threaded housing</p>	<p>Cylindrical threaded housing</p>	<p>Cylindrical threaded housing</p>	
<p>Thread size</p>	<p>M4 x 0.5 M5 x 0.5</p>	<p>M8 x 1 M12 x 1 M18 x 1 M30 x 1.5</p>	<p>M8 x 1 M12 x 1 M18 x 1 M30 x 1.5</p>	
<p>Sensing range S_n</p>	<p>0.6 mm ... 1.5 mm</p>	<p>1.5 ... 20 mm</p>	<p>3 mm ... 40 mm</p>	
<p>Housing material</p>	<p>Stainless steel</p>	<p>Metal</p>	<p>Metal</p>	
<p>Enclosure rating</p>	<p>IP 67</p>	<p>IP 67</p>	<p>IP 67</p>	
<p>At a glance</p>				
	<ul style="list-style-type: none"> • Types M4 and M5 • Small housing sizes and light weight • Integrated LED indicator • Rugged stainless steel housing 	<ul style="list-style-type: none"> • Types M8 to M30 • IP 67 enclosure rating • Operating temperature from -25 ° C to +75 ° C • 2-wire, 3-wire and 4-wire variants • AC, DC and AC/DC variants 	<ul style="list-style-type: none"> • Types M8 to M30 • Triple sensing range up to 40 mm • Operating temperature from -25 ° C to +70 ° C • High switching frequencies 	
<p>Detailed information</p>	<p style="text-align: center;">→ C-29</p>	<p style="text-align: center;">→ C-29</p>	<p style="text-align: center;">→ C-98</p>	

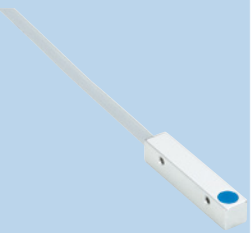

C

			
IMF Food & beverage	IM Inox	IM Namur	IMA Analog
Inductive sensors for wash down environments	Single-piece stainless steel sensors for the highest demands	Namur sensors for explosive zones	Analog inductive sensors with triple sensing range
Cylindrical threaded housing	Cylindrical threaded housing	Cylindrical threaded housing	Cylindrical threaded housing
M12 x 1 M18 x 1	M12 x 1 M18 x 1 M30 x 1.5	M8 x 1 M12 x 1 M18 x 1 M30 x 1.5	M8 x 1 M12 x 1 M18 x 1 M30 x 1.5
2 mm ... 12 mm	6 mm ... 40 mm	1 mm ... 15 mm	4 mm ... 40 mm
Stainless steel	Stainless steel	Metal	Metal
IP 68, IP 69K	IP 68, IP 69K	IP 67	IP 67
<ul style="list-style-type: none"> Types M12 and M18 Extremely watertight (IP 68/IP 69K) for wash down environments Stainless steel housing (316L/1.4404) Front cap made of PPS (FDA-certified material) Extended temperature range (-40 to +80 °C). Tolerates short-term temperature increases up to 100 °C Resistant to industrial cleaning agents, ECOLAB and JohnsonDiversey certified Laser etched part number 	<ul style="list-style-type: none"> Stainless steel housing (316L/1.4404) Extremely watertight (IP 68/IP 69K) Triple sensing range High resistance to mechanical stress Watertight housing suitable for use in hygienic and wash down areas Resistant to aggressive cleaning agents Visual adjustment indicator via output LED 	<ul style="list-style-type: none"> Types M8 to M30 Namur sensor for safe applications ATEX device category 1G and 2G Output according to DIN EN 60947-5-6 	<ul style="list-style-type: none"> Types M8 to M30 Analog output signal is proportional to distance Triple sensing range Analog current and voltage signal in one sensor High repeatability No blind zone
→ C-110	→ C-118	→ C-124	→ C-132

Product family overview

					
	<p>IH Miniature</p> <p>Space-saving miniature smooth inductive sensors</p>	<p>IH Standard</p> <p>Smooth cylindrical housing for time-saving installations</p>	<p>IQ Miniature</p> <p>Rectangular, small and space-saving</p>	<p>IQ Flat</p> <p>Low profile sensors when space is at a premium</p>	
<p>Technical data overview</p>					
<p>Housing</p>	<p>Cylindrical smooth housing</p>	<p>Cylindrical smooth housing</p>	<p>Rectangular housing</p>	<p>Rectangular housing</p>	
<p>Dimensions</p>	<p>-</p>	<p>-</p>	<p>5 mm x 5 mm x 25 mm 8 mm x 8 mm x 40 mm</p>	<p>8 mm x 16 mm x 4 mm 10 mm x 30 mm x 6 mm 20 mm x 32 mm x 8 mm 25 mm x 50 mm x 10 mm</p>	
<p>Diameter</p>	<p>3 mm / 4 mm</p>	<p>6.5 mm ... 34 mm</p>	<p>-</p>	<p>-</p>	
<p>Sensing range S_n</p>	<p>0.6 mm ... 0.8 mm</p>	<p>1.5 mm ... 30 mm</p>	<p>0.8 mm ... 4 mm</p>	<p>1.5 mm ... 7 mm</p>	
<p>Housing material</p>	<p>Stainless steel</p>	<p>Stainless steel / Plastic</p>	<p>Metal / Plastic</p>	<p>Metal / Plastic</p>	
<p>Enclosure rating</p>	<p>IP 67</p>	<p>IP 67</p>	<p>IP 67</p>	<p>IP 67</p>	
<p>At a glance</p>					
	<ul style="list-style-type: none"> • Small housing and light weight • Housing diameters of 3 and 4 mm • Integrated LED indicator • Rugged IP 67-rated stainless steel housing • Flexible connectivity via connecting cable or connector 	<ul style="list-style-type: none"> • Sensing range up to 30 mm • High switching frequencies up to 5 kHz • DC and AC/DC versions available • Plastic or stainless steel housing • Available in short and standard housing lengths 	<ul style="list-style-type: none"> • Long sensing range • Rugged metal and plastic housings • Narrow design: 5 x 5 or 8 x 8 mm • Compact, space-saving design 	<ul style="list-style-type: none"> • Flat, compact design • Long sensing range up to 7mm • Easily visible indication LEDs • Available in a plastic (IQ04 and IQ06) and metal housing (IQ20 and IQ25) 	
<p>Detailed information</p>	<p>→ C-142</p>	<p>→ C-148</p>	<p>→ C-156</p>	<p>→ C-162</p>	

C

 <p>IQ10</p>	 <p>IQ12</p>	 <p>IQ40</p>	 <p>IQ80</p>
<p>An all around solution for many applications</p>	<p>Economic, best-in-class performance</p>	<p>Tried and trusted housing style in 40 x 40 mm dimension</p>	<p>Rugged and flat in 80 x 80 mm housing</p>
<p>Rectangular housing</p>	<p>Rectangular housing</p>	<p>Rectangular housing</p>	<p>Rectangular housing</p>
<p>10 mm x 16 mm x 28 mm</p>	<p>12 mm x 26 mm x 40 mm</p>	<p>40 mm x 40 mm x 66 mm 40 mm x 40 mm x 118 mm 40 mm x 40 mm x 121 mm</p>	<p>80 mm x 40 mm x 105 mm 80 mm x 40 mm x 112 mm</p>
<p>-</p>	<p>-</p>	<p>-</p>	<p>-</p>
<p>3 mm ... 6 mm</p>	<p>4 mm ... 8 mm</p>	<p>15 mm ... 40 mm</p>	<p>50 mm ... 60 mm</p>
<p>Plastic</p>	<p>Plastic</p>	<p>Plastic</p>	<p>Plastic / Metal</p>
<p>IP 67, IP 68</p>	<p>IP 67, IP68</p>	<p>IP 65 / IP 67 / IP 68</p>	<p>IP 65 / IP 67</p>
<ul style="list-style-type: none"> • Extended sensing range of up to 6 mm • Tough VISTAL™ housing • SICK-ASIC technology • 270° status display with extra-bright LED • Hotmelt molding • Withstands high installation and tightening torque • IP 67, IP 68 enclosure rating 	<ul style="list-style-type: none"> • Extended sensing range of up to 8 mm • Tough VISTAL™ housing • SICK-ASIC technology • 270° status display with extra-bright LED • Hotmelt molding • Withstands high installation and tightening torque • IP 67, IP68 enclosure rating 	<ul style="list-style-type: none"> • Increased sensing range up to 40 mm • Corner LEDs • Sensing face rotatable in five directions • Sturdy and compact design • Integrated mounting clamp • DC and AC/DC versions available 	<ul style="list-style-type: none"> • Sensing range adjustable to 60 mm • Configurable NO or NC function • Terminal or M12 connection • DC and AC/DC versions available
<p>→ C-168</p>	<p>→ C-174</p>	<p>→ C-180</p>	<p>→ C-190</p>

C

Space-saving miniature threaded inductive sensors

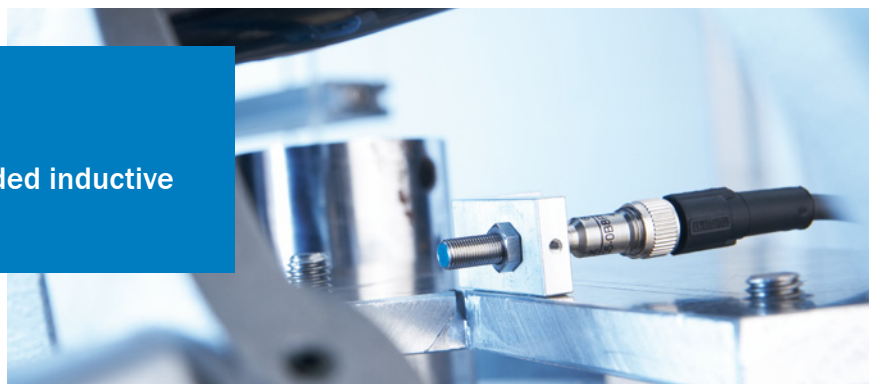

Product description

The tough and reliable IM Miniature inductive proximity sensor family can be mounted in applications with limited space. These miniature sensors are ideal for highly dynamic applications in

robotics, handling, and assembly. Despite their small size, these sensors provide maximum performance with operating distances up to 1.5 mm and integrated electronics.

At a glance

- Small housing sizes and light weight
- Integrated LED indicator
- Rugged stainless steel housing
- M4 and M5 thread sizes available

Your benefits

- Trouble-free installation in space-critical applications provides a high degree of design freedom, saving machine space
- Reliable detection of rapid handling and assembly processes increases throughput
- High-visibility indicator LED for simple monitoring of operational state reduces commissioning time
- High positioning accuracy increases machine throughput
- High resistance to shock and vibrations reduces maintenance costs



Additional information

Detailed technical data C-33
 Ordering information C-34
 Dimensional drawings C-34
 Connection diagram C-35
 Installation note C-35
 Recommended accessories C-36

→ www.mysick.com/en/IM_Minature
 For more information, just enter the link or scan the QR code and get direct access to technical data, CAD design models, operating instructions, software, application examples and much more.



Detailed technical data

Features

	IM04	IM05
Housing	M4 x 0.5	M5 x 0.5
Sensing range S_n	0.6 mm	0.8 mm / 1.5 mm
Assured sensing range S_a	0.486 mm	0.65 mm / 1.22 mm
Installation type	Flush	
Switching frequency	5,000 Hz	5,000 Hz / 3,000 Hz
Output type	PNP / NPN	
Output function	NO / NC	
Electrical wiring	DC 3-wire	
Enclosure rating ¹⁾	IP 67	

¹⁾ According to EN60529.

Mechanical / electrical

	IM04	IM05
Supply voltage	10 V DC ... 30 V DC	
Ripple ¹⁾	≤ 20 %	
Voltage drop ²⁾	≤ 2 V	
Power consumption ³⁾	≤ 10 mA	
Time delay before availability	≤ 10 ms	
Hysteresis	1 % ... 10 %	
Repeatability ⁴⁾	≤ 2 %	≤ 1.5 %
Temperature drift (% of S_r)	≤ 10 %	
EMC	According to EN 60947-5-2	
Output current I_a	≤ 100 mA	≤ 200 mA
Connection type	Cable, 2 m, PUR / Cable with connector and knurled nuts, 0.2 m, PUR	Connector, M8 / Cable, 2 m, PVC / Cable, 2 m, PUR
Short-circuit protection	✓	
Reverse polarity protection	✓	
Shock/vibration	30 g, 11 ms/10 ... 55 Hz, 1 mm	
Ambient operating temperature	-25 °C ... +70 °C	
Housing material	Stainless steel	
Housing cap material	Plastic, Polyester	Plastic, PA 66
Max. tightening torque	0.8 Nm	1.5 Nm
Reduction factor R_m	The values are reference values which may vary	
Stainless steel (V2A)	0.8	0.75
Aluminum (Al)	0.55	0.4
Copper (Cu)	0.5	0.4
Brass (Br)	0.65	0.5

¹⁾ Of V_s .

²⁾ With $I_a = 200$ mA.

³⁾ Without load.

⁴⁾ $U_b = 20 \dots 30$ VDC, $T_a = 23 \text{ °C} \pm 5 \text{ °C}$.

C

Ordering information

IM04

- Housing: M4 x 0.5
- Installation: flush

Sensing range S _n	Output function	Output type	Connection	Connection diagram	Type	Part no.
0.6 mm	NO	PNP	Cable, 3-wire, 2 m, PUR	Cd-001	IM04-0B6PS-ZU1	6020145
			Cable with connector, M8, 3-pin, with knurled nuts, 0.2 m, PUR	Cd-002	IM04-0B6PS-ZR1	6042085
	NC	NPN	Cable, 3-wire, 2 m, PUR	Cd-001	IM04-0B6NS-ZU1	6020146
		PNP	Cable, 3-wire, 2 m, PUR	Cd-003	IM04-0B6PO-ZU1	6020147

IM05

- Housing: M5 x 0.5
- Installation: flush

Sensing range S _n	Output function	Output type	Connection	Connection diagram	Type	Part no.
0.8 mm	NO	PNP	Connector M8, 3-pin	Cd-002	IM05-0B8PS-ZT1	6020110
			Cable, 3-wire, 2 m, PVC	Cd-001	IM05-0B8PS-ZW1	6011591
	NC	NPN	Connector M8, 3-pin	Cd-002	IM05-0B8NS-ZT1	6020158
			Cable, 3-wire, 2 m, PVC	Cd-001	IM05-0B8NS-ZW1	6020155
1.5 mm	NO	PNP	Connector M8, 3-pin	Cd-002	IM05-1B5PSVT0S	6049739
			Cable, 3-wire, 2 m, PUR	Cd-001	IM05-1B5PSVU2S	6049735
		NPN	Connector M8, 3-pin	Cd-002	IM05-1B5NSVT0S	6049737
			Cable, 3-wire, 2 m, PUR	Cd-001	IM05-1B5NSVU2S	6049733
	NC	PNP	Connector M8, 3-pin	Cd-004	IM05-1B5POVT0S	6049740
			Cable, 3-wire, 2 m, PUR	Cd-003	IM05-1B5POVU2S	6049736
		NPN	Connector M8, 3-pin	Cd-004	IM05-1B5NOVT0S	6049738
			Cable, 3-wire, 2 m, PUR	Cd-003	IM05-1B5NOVU2S	6049734

Dimensional drawings

IM04, cable

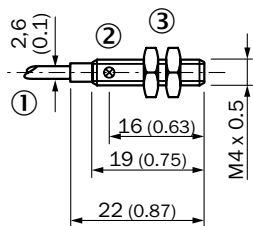

All dimensions in mm (inch)

- ① Connection
- ② LED indicator
- ③ Fastening nuts (2 x); 6 mm hex, stainless steel

IM05-xBxxx-xTx(x), connector

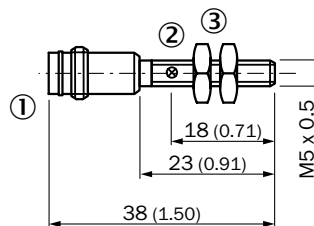

All dimensions in mm (inch)

- ① Connection
- ② LED indicator
- ③ Fastening nuts (2 x); 7 mm hex, stainless steel

**IM05-xBxxx-xWx, IM05-xBxxx-xUxx,
cable, cable with connector**

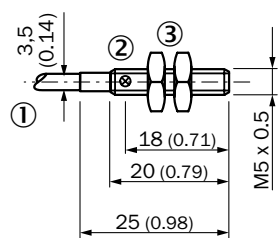

All dimensions in mm (inch)

- ① Connection
- ② LED indicator
- ③ Fastening nuts (2 x); 7 mm hex, stainless steel

Connection diagram

Cd-001

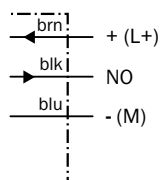

Cd-002

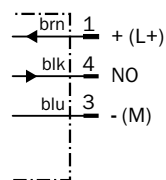

Cd-003

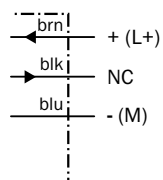

Cd-004

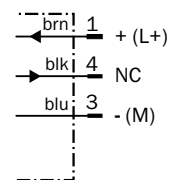

C

Installation note

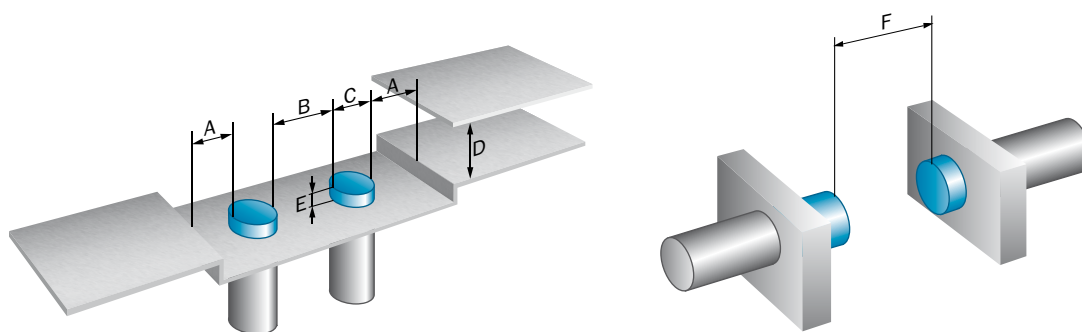





	Sensing range Sn	A	B	C	D	E	F
IM04	0.6 mm	0 mm	0 mm	4 mm	1.8 mm	0 mm	5 mm
IM05-0B8xx-xxx	0.8 mm	0.8 mm	0 mm	5 mm	2.4 mm	0 mm	7 mm
IM05-1B5xx-xxx	1.5 mm	1.5 mm	1 mm	5 mm	4.5 mm	0 mm	12 mm

Recommended accessories

Cordsets and connectors

Connector M8, 3-pin

- Connector type: Female connector
- Enclosure rating: IP 67

Figure	Configuration	Jacket material	Cable length	Model name	Part no.
	Straight	PVC	2 m	DOL-0803-G02M	6010785
			5 m	DOL-0803-G05M	6022009
	Right angle	PVC	2 m	DOL-0803-W02M	6008489
			5 m	DOL-0803-W05M	6022010
	Straight	PBT	-	DOS-0803-G	7902077
	Right angle	PBT	-	DOS-0803-W	7902078

→ For additional accessories, please see page G-255

C

C

3-wire sensors in M8 housing for industrial use

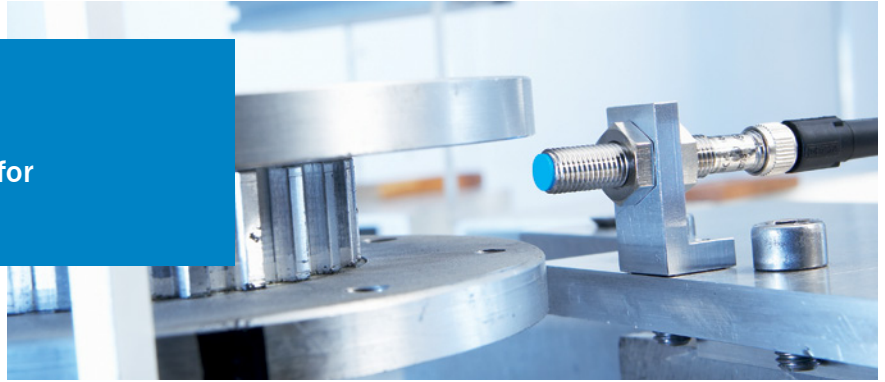

Product description

SICK's IM Standard cylindrical inductive proximity sensors offer precise detection, less downtime and a long service life. The standard cylindrical inductive sensor family includes IME inductive sensors, which feature advanced ASIC technology. This enables digital adjustment after the end of the manufacturing process. Proprietary ASIC technology eliminates

production tolerances, enabling the IME to provide highly accurate and repeatable detection for any number of production runs. IME sensors are completely encapsulated with hot melt technology, which increases these sensors' life under shock and vibration. The customer benefits from high position accuracy in the machine and long term reliability.

At a glance

- Size M8
- DC 3-wire
- Expanded sensing range of up to 4 mm
- IP 67 enclosure rating
- Operating temperature from -25° C to +75° C

Your benefits

- Reduced machine downtime
- Reduced mechanical damage
- Fewer maintenance costs due to longer service life
- High resistance to shock and vibrations



Additional information

Detailed technical data..... C-39
 Ordering information..... C-40
 Dimensional drawing C-42
 Connection diagram C-43
 Installation note C-44
 Recommended accessories..... C-44

→ www.mysick.com/en/IME08
 For more information, just enter the link or scan the QR code and get direct access to technical data, CAD design models, operating instructions, software, application examples and much more.



Detailed technical data

Features

Housing	M8 x 1
Sensing range S_n	Flush 1.5 mm / 2 mm
	Non-flush 2.5 mm / 4 mm
Assured sensing range S_a	Flush 1.215 mm / 1.62 mm
	Non-flush 2.025 mm / 3.24 mm
Installation type	Flush / Non-flush
Switching frequency	4,000 Hz
Output type	NPN / PNP
Output function	NO / NC
Electrical wiring	DC 3-wire
Enclosure rating ¹⁾	IP 67

¹⁾ According to EN60529.

Mechanical / electrical

Supply voltage	10 V DC ... 30 V DC
Ripple	≤ 10 %
Voltage drop	≤ 2 V
Current consumption ¹⁾	≤ 10 mA
Time delay before availability	≤ 100 ms
Hysteresis	5 % ... 15 %
Repeatability ^{2) 3)}	≤ 2 %
Temperature drift (% of S_r)	± 10 %
EMC	According to EN 60947-5-2
Output current I_a	≤ 200 mA
Connection type	Cable, 2 m, PVC / Connector, M8 / Connector, M12
Wire-break protection	✓
Short-circuit protection	✓
Reverse polarity protection	✓
Power-up pulse protection	✓
Shock/vibration	30 g, 11 ms/10 ... 55 Hz, 1 mm
Operating temperature	-25 °C ... +75 °C
Housing material	Metal, Nickel-plated brass
Housing cap material	Plastic, PA6
Tightening torque, max	Typ. 5 Nm
Reduction factor R_M	The values are reference values which may vary
Carbon steel St37 (Fe)	1
Stainless steel (V2A, 304)	0.8
Aluminum (Al)	0.45
Copper (Cu)	0.4
Brass (Br)	0.4

¹⁾ Without load.

²⁾ U_b and T_a constant.

³⁾ Of S_r .

Ordering information

Sensing range S_n : 1.5 mm

Installation	Output function	Output type	Connection	Housing	Connection diagram	Model name	Part no.
Flush	NO	PNP	Cable, 3-wire, 2 m, PVC	Short-body housing	Cd-001	IME08-1B5PSZW2K	1040839
				Standard	Cd-001	IME08-1B5PSZW2S	1040840
			Connector M8, 3-pin	Short-body housing	Cd-002	IME08-1B5PSZT0K	1040837
				Standard	Cd-002	IME08-1B5PSZT0S	1040838
		NPN	Cable, 3-wire, 2 m, PVC	Short-body housing	Cd-001	IME08-1B5NSZW2K	1040847
				Standard	Cd-001	IME08-1B5NSZW2S	1040848
			Connector M8, 3-pin	Short-body housing	Cd-002	IME08-1B5NSZT0K	1040845
				Standard	Cd-002	IME08-1B5NSZT0S	1040846
	NC	PNP	Cable, 3-wire, 2 m, PVC	Short-body housing	Cd-003	IME08-1B5POZW2K	1040843
				Standard	Cd-003	IME08-1B5POZW2S	1040844
			Connector M8, 3-pin	Short-body housing	Cd-004	IME08-1B5POZT0K	1040841
				Standard	Cd-004	IME08-1B5POZT0S	1040842
		NPN	Cable, 3-wire, 2 m, PVC	Short-body housing	Cd-003	IME08-1B5NOZW2K	1040851
				Standard	Cd-003	IME08-1B5NOZW2S	1040852
			Connector M8, 3-pin	Short-body housing	Cd-004	IME08-1B5NOZT0K	1040849
				Standard	Cd-004	IME08-1B5NOZT0S	1040850

Sensing range S_n : 2 mm

Installation	Output function	Output type	Connection	Housing	Connection diagram	Model name	Part no.	
Flush	NO	PNP	Cable, 3-wire, 2 m, PVC	Short-body housing	Cd-001	IME08-02BPSZW2K	1040871	
				Standard	Cd-003	IME08-02BPSZW2S	1040872	
			Connector M8, 3-pin	Short-body housing	Cd-002	IME08-02BPSZT0K	1040869	
				Standard	Cd-002	IME08-02BPSZT0S	1040870	
		Connector M12, 4-pin	Standard	Cd-007	IME08-02BPSZC0S	1051205		
			Cable, 3-wire, 2 m, PVC	Short-body housing	Cd-001	IME08-02BNSZW2K	1040879	
				Standard	Cd-001	IME08-02BNSZW2S	1040880	
			Connector M8, 3-pin	Short-body housing	Cd-002	IME08-02BNSZT0K	1040877	
	Standard	Cd-002		IME08-02BNSZT0S	1040878			
	Connector M12, 4-pin	Standard	Cd-007	IME08-02BNSZC0S	1051127			
		NC	PNP	Cable, 3-wire, 2 m, PVC	Short-body housing	Cd-003	IME08-02BPOZW2K	1040875
					Standard	Cd-003	IME08-02BPOZW2S	1040876
				Connector M8, 3-pin	Short-body housing	Cd-004	IME08-02BPOZT0K	1040873
	Standard				Cd-004	IME08-02BPOZT0S	1040874	
	Connector M12, 4-pin		Standard	Cd-003	IME08-02BPOZC0S	1051207		
			Cable, 3-wire, 2 m, PVC	Short-body housing	Cd-003	IME08-02BNOZW2K	1040883	
Standard				Cd-003	IME08-02BNOZW2S	1040884		
Connector M8, 3-pin			Short-body housing	Cd-004	IME08-02BNOZT0K	1040881		
	Standard	Cd-004	IME08-02BNOZT0S	1040882				

Sensing range S_n : 2.5 mm

Installation	Output function	Output type	Connection	Housing	Connection diagram	Model name	Part no.
Non-flush	NO	PNP	Cable, 3-wire, 2 m, PVC	Short-body housing	Cd-001	IME08-2N5PSZW2K	1040855
				Standard	Cd-001	IME08-2N5PSZW2S	1040856
			Connector M8, 3-pin	Short-body housing	Cd-002	IME08-2N5PSZT0K	1040853
				Standard	Cd-002	IME08-2N5PSZT0S	1040854
		NPN	Cable, 3-wire, 2 m, PVC	Short-body housing	Cd-001	IME08-2N5NSZW2K	1040863
				Standard	Cd-001	IME08-2N5NSZW2S	1040864
			Connector M8, 3-pin	Short-body housing	Cd-002	IME08-2N5NSZT0K	1040861
				Standard	Cd-002	IME08-2N5NSZT0S	1040862
	NC	PNP	Cable, 3-wire, 2 m, PVC	Short-body housing	Cd-003	IME08-2N5POZW2K	1040859
				Standard	Cd-003	IME08-2N5POZW2S	1040860
			Connector M8, 3-pin	Short-body housing	Cd-004	IME08-2N5POZT0K	1040857
				Standard	Cd-004	IME08-2N5POZT0S	1040858
		NPN	Cable, 3-wire, 2 m, PVC	Short-body housing	Cd-003	IME08-2N5NOZW2K	1040867
				Standard	Cd-003	IME08-2N5NOZW2S	1040868
			Connector M8, 3-pin	Short-body housing	Cd-004	IME08-2N5NOZT0K	1040865
				Standard	Cd-004	IME08-2N5NOZT0S	1040866

C

Sensing range S_n : 4 mm

Installation	Output function	Output type	Connection	Housing	Connection diagram	Model name	Part no.
Non-flush	NO	PNP	Cable, 3-wire, 2 m, PVC	Short-body housing	Cd-001	IME08-04NPSZW2K	1040887
				Standard	Cd-001	IME08-04NPSZW2S	1040888
			Connector M8, 3-pin	Short-body housing	Cd-002	IME08-04NPSZT0K	1040885
				Standard	Cd-002	IME08-04NPSZT0S	1040886
		NPN	Cable, 3-wire, 2 m, PVC	Short-body housing	Cd-001	IME08-04NNSZW2K	1040895
				Standard	Cd-001	IME08-04NNSZW2S	1040896
			Connector M8, 3-pin	Short-body housing	Cd-002	IME08-04NNSZT0K	1040893
				Standard	Cd-002	IME08-04NNSZT0S	1040894
	NC	PNP	Cable, 3-wire, 2 m, PVC	Standard	Cd-003	IME08-04NPOZW2S	1040892
				Short-body housing	Cd-003	IME08-04NPOZW2K	1040891
			Connector M8, 3-pin	Short-body housing	Cd-004	IME08-04NPOZT0K	1040889
				Standard	Cd-004	IME08-04NPOZT0S	1040890
		NPN	Cable, 3-wire, 2 m, PVC	Standard	Cd-008	IME08-04NPOZC0S	1051208
				Short-body housing	Cd-003	IME08-04NNOZW2K	1040899
			Connector M8, 3-pin	Standard	Cd-003	IME08-04NNOZW2S	1040900
				Short-body housing	Cd-004	IME08-04NNOZT0K	1040897
Standard	Cd-004	IME08-04NNOZT0S	1040898				

Dimensional drawing

IME08-xBxxxW2K,
flush, cable, short-body housing

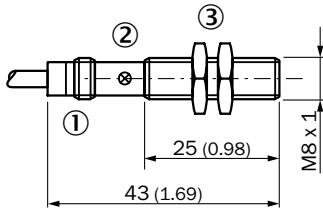

All dimensions in mm (inch)

- ① Connection
- ② LED indicator
- ③ Fastening nuts (2 x); width across 13, metal

IME08-xBxxxW2,
flush, cable, standard

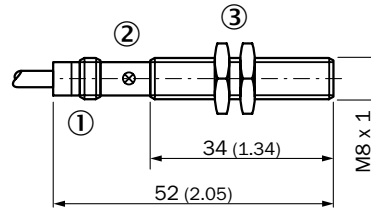

All dimensions in mm (inch)

- ① Connection
- ② LED indicator
- ③ Fastening nuts (2 x); width across 13, metal

C

IME08-xBxxxxTOK,
flush, connector, short-body housing

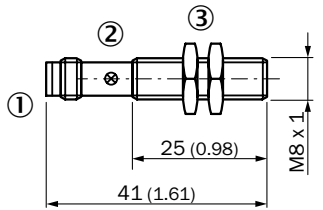

All dimensions in mm (inch)

- ① Connection
- ② LED indicator
- ③ Fastening nuts (2 x); width across 13, metal

IME08-xBxxxxTOS,
flush, connector, standard

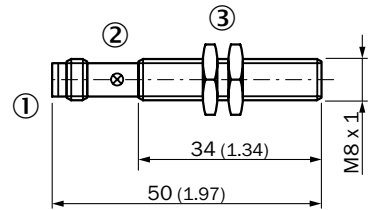

All dimensions in mm (inch)

- ① Connection
- ② LED indicator
- ③ Fastening nuts (2 x); width across 13, metal

IME08-xBxxxxC0S,
flush, connector M12, standard

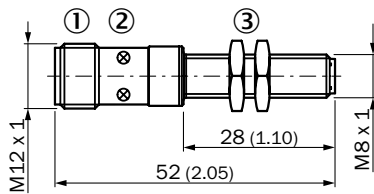

All dimensions in mm (inch)

- ① Connection
- ② LED indicator
- ③ Fastening nuts (2 x); width across 13, metal

IME08-xNxxxxW2K,
non-flush, cable, short-body housing,

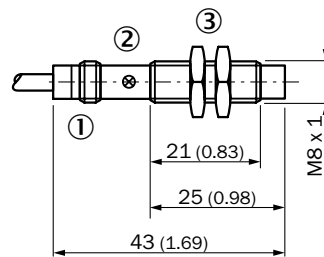

All dimensions in mm (inch)

- ① Connection
- ② LED indicator
- ③ Fastening nuts (2 x); width across 13, metal

IME08-xNxxxxW2S,
non-flush, cable, standard

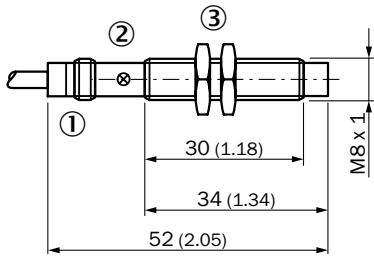

All dimensions in mm (inch)

- ① Connection
- ② LED indicator
- ③ Fastening nuts (2 x); width across 13, metal

IME08-xNxxxxTOK,
non-flush, connector, short-body housing

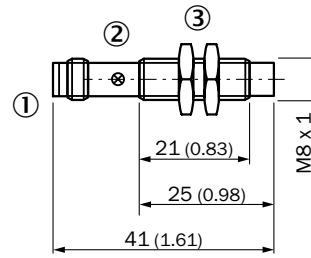

All dimensions in mm (inch)

- ① Connection
- ② LED indicator
- ③ Fastening nuts (2 x); width across 13, metal

IME08-xNxxxxTOS,
non-flush, connector, standard

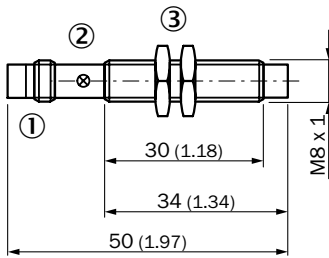

All dimensions in mm (inch)

- ① Connection
- ② LED indicator
- ③ Fastening nuts (2 x); width across 13, metal

IME08-xNxxxCOS,
non-flush, connector M12, standard

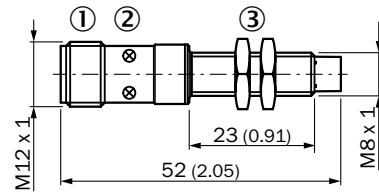

All dimensions in mm (inch)

- ① Connection
- ② LED indicator
- ③ Fastening nuts (2 x); width across 13, metal



Connection diagram

Cd-001

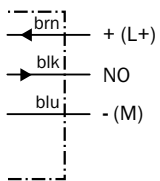

Cd-002

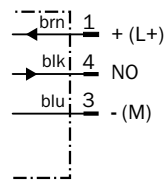

Cd-003

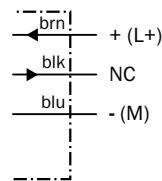

Cd-004

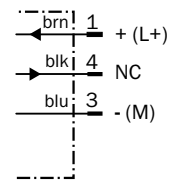

Cd-007

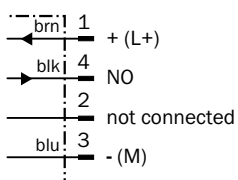

Cd-008

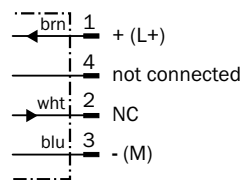

Installation note

Flush installation

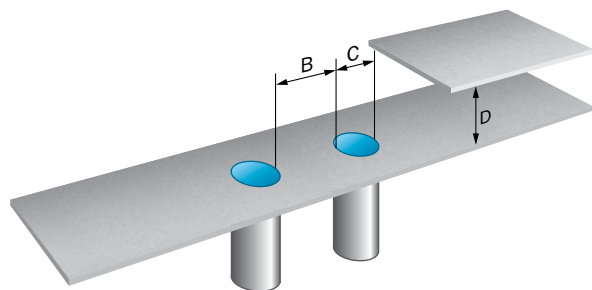

Non-flush installation

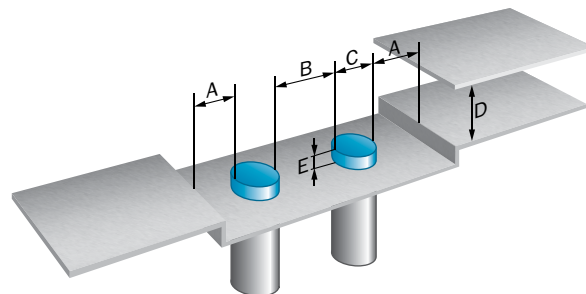

Opposite installation

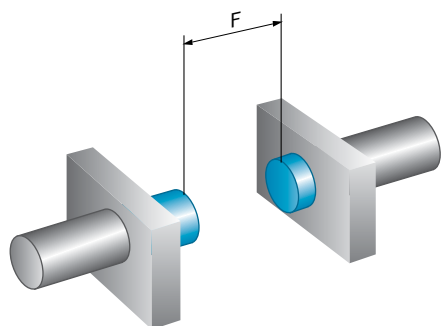

C

	Installation type	Sensing range Sn	A	B	C	D	E	F
IME08-1B5xxxxxx	Flush	1.5 mm	-	8 mm	8 mm	4.5 mm	-	12 mm
IME08-02Bxxxxxx	Flush	2 mm	-	16 mm	8 mm	6 mm	-	16 mm
IME08-2N5xxxxxx	Non-flush	2.5 mm	8 mm	16 mm	8 mm	7.5 mm	6 mm	20 mm
IME08-04Nxxxxxx	Non-flush	4 mm	8 mm	18 mm	8 mm	12 mm	8 mm	32 mm

Recommended accessories

Mounting brackets







- Accessory type: Mounting brackets
- Material: Steel, zinc coated

Figure	Thread size	Configuration	Model name	Part no.
	M8	Straight	BEF-WG-M08	5321722
		Right angle	BEF-WN-M08	5321721

Cordsets and connectors





Connector M12, 4-pin

- Enclosure rating: IP 67

Figure	Connector type	Configuration	Jacket material	Cable length	Model name	Part no.	
	Female connector	Straight	PVC	2 m	DOL-1204-G02M	6009382	
				5 m	DOL-1204-G05M	6009866	
				10 m	DOL-1204-G10M	6010543	
		Right angle	PVC	2 m	DOL-1204-W02M	6009383	
				5 m	DOL-1204-W05M	6009867	
				10 m	DOL-1204-W10M	6010541	
		Male connector	Straight	PBT	-	DOS-1204-G	6007302
			Right angle	PBT	-	DOS-1204-W	6007303
		Male connector	Straight	PBT	-	STE-1204-G	6009932
	Right angle		PBT	-	STE-1204-W	6022084	

Connector M8, 3-pin

- Connector type: Female connector
- Enclosure rating: IP 67

Figure	Configuration	Jacket material	Cable length	Model name	Part no.
	Straight	PVC	2 m	DOL-0803-G02M	6010785
			5 m	DOL-0803-G05M	6022009
			10 m	DOL-0803-G10M	6022011
	Right angle	PVC	2 m	DOL-0803-W02M	6008489
			5 m	DOL-0803-W05M	6022010
			10 m	DOL-0803-W10M	6022012
	Straight	PBT	-	DOS-0803-G	7902077
	Right angle	PBT	-	DOS-0803-W	7902078

Terminal and alignment brackets

- Accessory type: Terminal brackets

Figure	Material	Model name	Part no.
	Plastic (PA12), glass-fiber reinforced, without fixed stop	BEF-KH-M08	2051477
	Plastic (PA12), glass-fiber reinforced, with fixed stop	BEF-KHF-M08	2051478

→ For additional accessories, please see page G-255

Ultrashort 3-wire sensors in M8 housing for industrial use



Product description

SICK's ultrashort sensors in M8 housing are extremely short, compact, lightweight and powerful. Modern ASIC technology guarantees a full range of services in the smallest dimensions, allowing for easy integration into compact housings and

applications. With switching frequencies of 5 kHz, it can easily handle fast assembly and handling processes and its low weight stands up well in highly dynamic applications.

At a glance

- Size M8
- Ultrashort design
- DC 3-wire
- Expanded sensing range of up to 1.5 mm
- Switching frequency of 5 kHz
- Operating temperature from -25° C to +70° C
- Short-body housing
- Ultra light

Your benefits

- Simple integration in compact housings
- Secure, rapid process detection
- A higher degree of freedom in machine design
- Fewer maintenance costs due to longer service life
- High resistance to shock and vibrations



Additional information

Detailed technical data C-47
 Ordering information C-48
 Dimensional drawings C-48
 Connection diagram C-48
 Installation note C-49
 Recommended accessories C-49

→ www.mysick.com/en/IM08

For more information, just enter the link or scan the QR code and get direct access to technical data, CAD design models, operating instructions, software, application examples and much more.



C

Detailed technical data

Features

Housing	M8 x 1
Sensing range S_n	1.5 mm
Assured sensing range S_a	1.22 mm
Installation type	Flush
Switching frequency	5,000 Hz
Output type	NPN / PNP
Output function	NO / NC
Electrical wiring	DC 3-wire
Enclosure rating ¹⁾	IP 67

¹⁾ According to EN60529.

Mechanical / electrical

Supply voltage	10 V DC ... 30 V DC
Ripple ¹⁾	≤ 20 %
Voltage drop ²⁾	≤ 2 V
Current consumption ³⁾	≤ 10 mA
Time delay before availability	≤ 10 ms
Hysteresis	≤ 10 %
Repeatability ^{4) 5)}	≤ 5 %
Temperature drift (% of S_p)	± 10 %
EMC	According to EN 60947-5-2
Output current I_a	≤ 200 mA
Connection type	Cable, 2 m, PVC / Connector, M8
Short-circuit protection	✓
Reverse polarity protection	✓
Power-up pulse protection	✓
Shock/vibration	30 g, 11 ms/10 ... 55 Hz, 1 mm
Ambient operating temperature	-25 °C ... +70 °C
Housing material	Metal, Nickel-plated brass
Housing cap material	Plastic
Tightening torque, max.	≤ 4 Nm
Reduction factor R_m	The values are reference values which may vary
Stainless steel (V2A, 304)	0.8
Aluminum (Al)	0.45
Copper (Cu)	0.4
Brass (Br)	0.5

¹⁾ Of V_S .

²⁾ At I_a max.

³⁾ Without load.

⁴⁾ U_b and T_a constant.

⁵⁾ Of S_r .

C

Ordering information

Sensing range S_n : 1.5 mm

- Housing: M8 x 1

Sensing range S_n	Installation	Output function	Output type	Connection	Connection diagram	Model name	Part no.
1.5 mm	Flush	NO	PNP	Cable, 3-wire, 2 m, PVC	Cd-001	IM08-1B5PS-ZWK	6020111
				Connector M8, 3-pin	Cd-002	IM08-1B5PS-ZTK	6020112
			NPN	Cable, 3-wire, 2 m, PVC	Cd-001	IM08-1B5NS-ZWK	6020173
				Connector M8, 3-pin	Cd-002	IM08-1B5NS-ZTK	6020176
		NC	PNP	Cable, 3-wire, 2 m, PVC	Cd-003	IM08-1B5PO-ZWK	6020174
				Connector M8, 3-pin	Cd-004	IM08-1B5PO-ZTK	6020177

Dimensional drawings

**IM08-xBxxx-xWK,
cable**

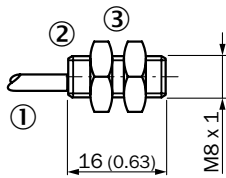

All dimensions in mm (inch)

- ① Connection
- ② LED indicator
- ③ Fastening nuts (2 x); width across 13, metal

**IM08-xBxxx-xTK,
connector**

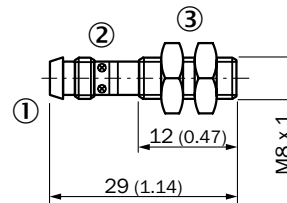

All dimensions in mm (inch)

- ① Connection
- ② LED indicator
- ③ Fastening nuts (2 x); width across 13, metal

Connection diagram

Cd-001

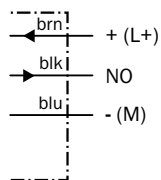

Cd-002

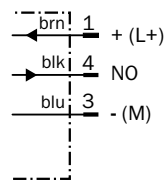

Cd-003

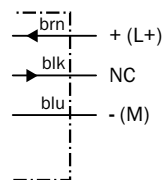

Cd-004

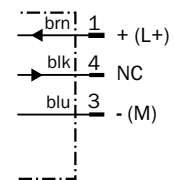

Installation note

Flush installation

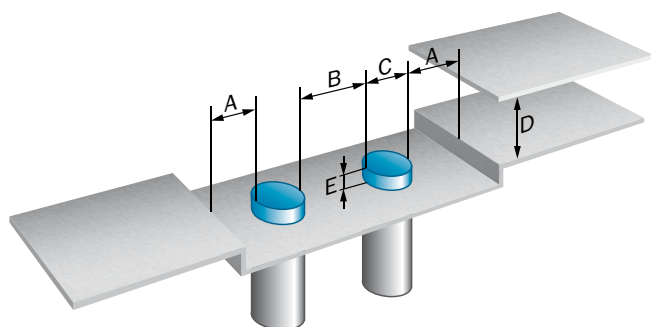

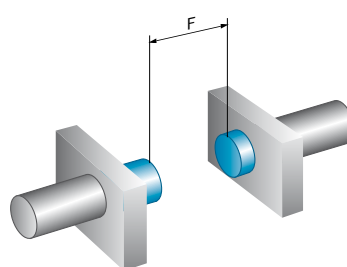

Opposite installation



	A	B	C	D	E	F
IM08	1.5 mm	2 mm	8 mm	4.5 mm	0 mm	12 mm

Recommended accessories



Mounting brackets

Figure	Description	Material	Configuration	Model name	Part no.
	Mounting bracket, M8	Steel, zinc coated	Straight	BEF-WG-M08	5321722
			Right angle	BEF-WN-M08	5321721

Cordsets and connectors

Connector M8, 3-pin

- Enclosure rating: IP 67

Figure	Connector type	Configuration	Jacket material	Cable length	Model name	Part no.
	Female connector	Straight	PVC	2 m	DOL-0803-G02M	6010785
				5 m	DOL-0803-G05M	6022009
Right angle		PVC	2 m	DOL-0803-W02M	6008489	
			5 m	DOL-0803-W05M	6022010	
	Female connector	Straight	PBT	-	DOS-0803-G	7902077
		Right angle	PBT	-	DOS-0803-W	7902078

Terminal and alignment brackets

- Accessory type: Terminal brackets

Figure	Material	Model name	Part no.
	Plastic (PA12), glass-fiber reinforced, without fixed stop	BEF-KH-M08	2051477
	Plastic (PA12), glass-fiber reinforced, with fixed stop	BEF-KHF-M08	2051478

→ For additional accessories, please see page G-255

2-wire sensors in M12 housing for industrial use



C



Additional information

Detailed technical data C-51
 Ordering information C-52
 Dimensional drawings C-53
 Connection diagram C-54
 Installation note C-54
 Recommended accessories C-55

Product description

The SICK family of inductive AC and DC 2-wire sensors offers a high level of reliability, robustness and a long service life. Low power consumption, reduced wiring requirement and integrated, easy handling of the 2-wire sensors make this sensor family extremely popular. As

with conventional, mechanical position switches, setting up a series connection is easy to do. This ensures that modern, non-contact inductive 2-wire sensors can be used in existing applications.

At a glance

- Size M12
- AC and DC 2-wire
- Expanded sensing range of up to 4 mm
- IP 67 enclosure rating
- Operating temperature from -25° C to +75° C

Your benefits

- Reduced wiring requirement
- Quick and easy to install
- Low power consumption
- Reduced machine downtime
- Fewer maintenance costs due to longer service life
- High resistance to shock and vibrations

→ www.mysick.com/en/IM12

For more information, just enter the link or scan the QR code and get direct access to technical data, CAD design models, operating instructions, software, application examples and much more.



Detailed technical data

Features

	DC 2-wire	AC 2-wire
Housing	M12 x 1	
Sensing range S_n	Flush	2 mm
	Non-flush	4 mm
Assured sensing range S_a	Flush	1.62 mm
	Non-flush	3.24 mm
Installation type	Flush / non-flush	
Switching frequency	1,500 Hz	25 Hz
Output function	NO / NC	
Electrical wiring	DC 2-wire	AC 2-wire
Enclosure rating ¹⁾	IP 67	

¹⁾ According to EN60529.

C

Mechanical / electrical

	DC 2-wire	AC 2-wire
Supply voltage	10 V DC ... 30 V DC	20 V AC ... 250 V AC
Ripple	≤ 10 %	
Voltage drop ¹⁾	≤ 2.8 V	≤ 8.5 V
Time delay before availability	≤ 50 ms	≤ 10 ms
Hysteresis	2 % ... 10 %	1 % ... 15 %
Repeatability ^{2) 3)}	≤ 5 %	≤ 10 %
Temperature drift (% of S_r)	± 10 %	
EMC	According to EN 60947-5-2	
Output current I_a	≤ 100 mA	≤ 250 mA, 50 °C ≤ 200 mA, 80 °C
Off-state current	≤ 0.8 mA	≤ 3 mA (AC 250 V) ≤ 1.5 mA (AC 120 V)
Load resistance, min.	≥ 3 mA	≥ 8 mA
Short-time withstand current	-	0.9 A ⁴⁾
Connection type	Connector, M12 / Cable, 2 m, PVC	Cable, 2 m, PUR-PVC
Short-circuit protection	✓	- ⁵⁾
Reverse polarity protection	✓	-
Power-up pulse protection	-	✓
Shock/vibration	30 g, 11 ms/10 ... 55 Hz, 1 mm	
Ambient operating temperature	-25 °C ... +70 °C	-25 °C ... +80 °C
Housing material	Metal, Nickel-plated brass	
Housing cap material	Plastic, PBT	Plastic, PC
Tightening torque, max.	10 Nm	≤ 7 Nm
Protection class	-	II

	DC 2-wire	AC 2-wire
Reduction factor R_m	The values are reference values which may vary	
Stainless steel (V2A, 304)		
Flush	0.8	
Non-flush	0.87	0.8
Aluminum (Al)		
Flush	0.35	0.45
Non-flush	0.57	0.45
Copper (Cu)		
Flush	0.3	0.4
Non-flush	0.52	0.4
Brass (Br)		
Flush	0.5	-
Non-flush	0.62	-

¹⁾ At I_a max.

²⁾ U_b and T_a constant.

³⁾ Of Sr.

⁴⁾ 20 ms / 0.5 Hz.

⁵⁾ Miniature fuse as per IEC 60217-2 Sheet 1, ≤ 2 A (quick-blow)

C

Ordering information

DC 2-wire

Sensing range S_n	Installation type	Output function	Connection	Connection diagram	Model name	Part no.
≤ 2 mm	Flush	NO	Connector M12, 4-pin	Cd-015	IM12-02BDS-ZC1	6020312
			Cable, 2-wire, 2 m, PVC	Cd-012	IM12-02BDS-ZW1	6020310
≤ 4 mm	Non-flush	NO	Connector M12, 4-pin	Cd-015	IM12-04NDS-ZC1	6020316
			Cable, 2-wire, 2 m, PVC	Cd-012	IM12-04NDS-ZW1	6020314
		NC	Connector M12, 4-pin	Cd-015	IM12-04NDO-ZC1	6020317
			Cable, 2-wire, 2 m, PVC	Cd-012	IM12-04NDO-ZW1	6020315

AC 2-wire

Sensing range S_n	Installation type	Output function	Connection	Connection diagram	Model name	Part no.
≤ 2 mm	Flush	NC	Cable, 2-wire, 2 m, PUR-PVC	Cd-214	IM12-02BAO-ZU0	7902119
		NO	Cable, 2-wire, 2 m, PUR-PVC	Cd-214	IM12-02BAS-ZU0	7902118
≤ 4 mm	Non-flush	NC	Cable, 2-wire, 2 m, PUR-PVC	Cd-214	IM12-04NAO-ZU0	7902121
		NO	Cable, 2-wire, 2 m, PUR-PVC	Cd-214	IM12-04NAS-ZU0	7902120

Dimensional drawings

IM12-02BDx-xC1, DC, flush, connector

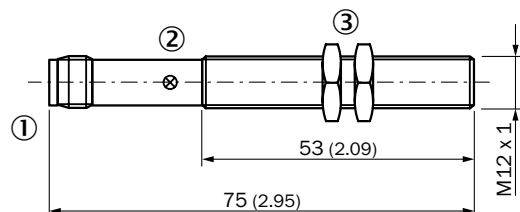

All dimensions in mm (inch)

- ① Connection
- ② LED indicator
- ③ Fastening nuts (2 x); width across 17, metal

IM12-02BDx-xW1, DC, flush, cable

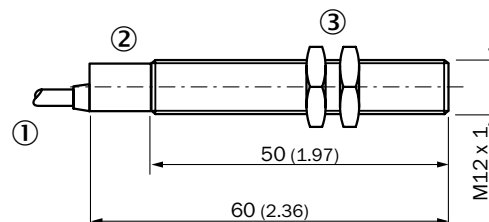

All dimensions in mm (inch)

- ① Connection
- ② LED indicator
- ③ Fastening nuts (2 x); width across 17, metal

IM12-04NDx-xC1, DC, non-flush, connector

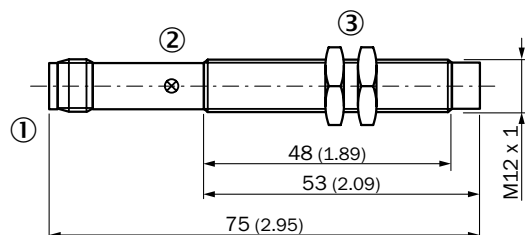

All dimensions in mm (inch)

- ① Connection
- ② LED indicator
- ③ Fastening nuts (2 x); width across 17, metal

IM12-04NDx-xW1, DC, non-flush, cable

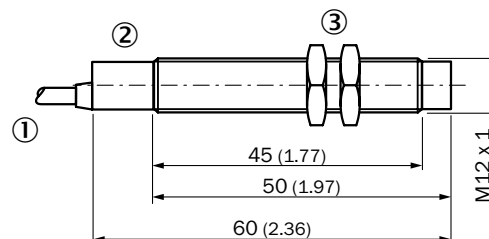

All dimensions in mm (inch)

- ① Connection
- ② LED indicator
- ③ Fastening nuts (2 x); width across 17, metal

IM12-02BAx-xU0, AC, flush, cable

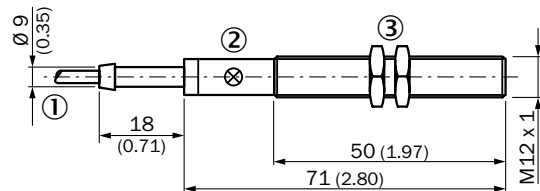

All dimensions in mm (inch)

- ① Connection
- ② LED indicator
- ③ Fastening nuts (2 x); width across 17, metal

IM12-04NAx-xU0, AC, non-flush, cable

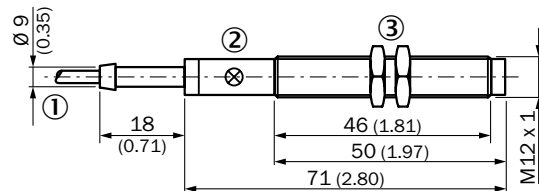

All dimensions in mm (inch)

- ① Connection
- ② LED indicator
- ③ Fastening nuts (2 x); width across 17, metal

C

Connection diagram

Cd-012

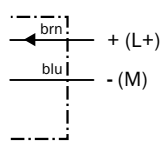

Cd-015

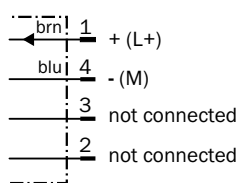

Cd-214

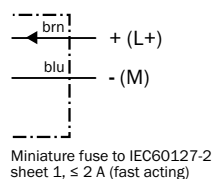

Installation note

Flush installation

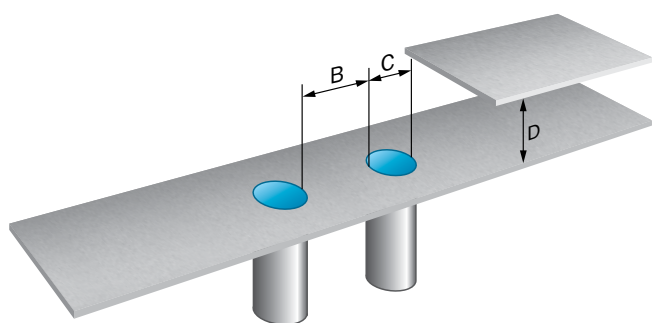

Non-flush installation

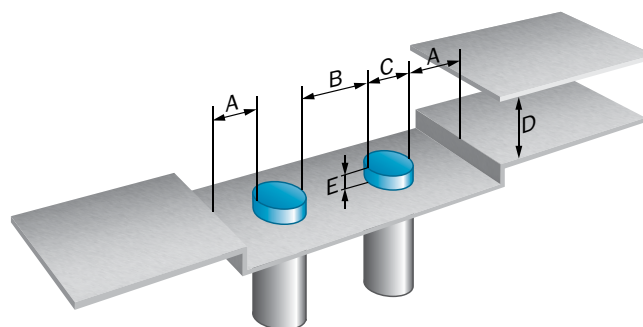

Opposite installation

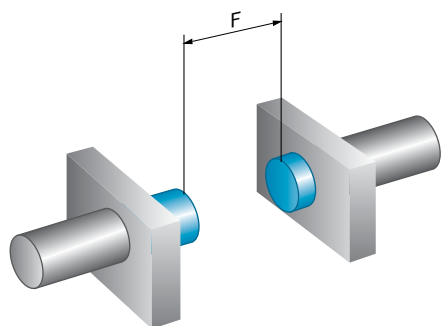



	Installation type	Electrical wiring	A	B	C	D	E	F
IM12-02BAx-xxx	Flush	DC 2-wire	0 mm	12 mm	12 mm	6 mm	0 mm	16 mm
IM12-02BCx-xxx	Flush	AC 2-wire	6 mm	12 mm	12 mm	6 mm	0 mm	16 mm
IM12-04NAx-xxx	Non-flush	DC 2-wire	12 mm	24 mm	12 mm	12 mm	8 mm	32 mm
IM12-04NCx-xxx	Non-flush	AC 2-wire	12 mm	24 mm	12 mm	12 mm	8 mm	32 mm

Recommended accessories





Mounting brackets

- **Accessory type:** Mounting brackets
- **Material:** Steel, zinc coated

Figure	Thread size	Configuration	Model name	Part no.
	M12	Straight	BEF-WG-M12	5321869
		Right angle	BEF-WN-M12	5308447

Cordsets and connectors

Connector M12, 4-pin

Figure	Connector type	Enclosure rating	Configuration	Jacket material	Cable length	Model name	Part no.
	Female connector	IP 67	Straight	PVC	2 m	DOL-1204-G02M	6009382
					5 m	DOL-1204-G05M	6009866
		IP 68	Right angle	PVC	2 m	DOL-1204-L02M	6027945
					5 m	DOL-1204-L05M	6027944
		IP 67	Right angle	PVC	2 m	DOL-1204-W02M	6009383
					5 m	DOL-1204-W05M	6009867
		IP 67	Straight	PBT	-	DOS-1204-G	6007302
					Right angle	PBT	-

Terminal and alignment brackets

- **Accessory type:** Terminal brackets
- **Material:** Plastic (PA12), glass-fiber reinforced

Figure	Description	Model name	Part no.
	Terminal bracket M12, without fixed stop	BEF-KH-M12	2051479
	Terminal bracket M12, with fixed stop	BEF-KHF-M12	2051480

→ For additional accessories, please see page G-255

3-/4-wire sensors in M12 housing for industrial use

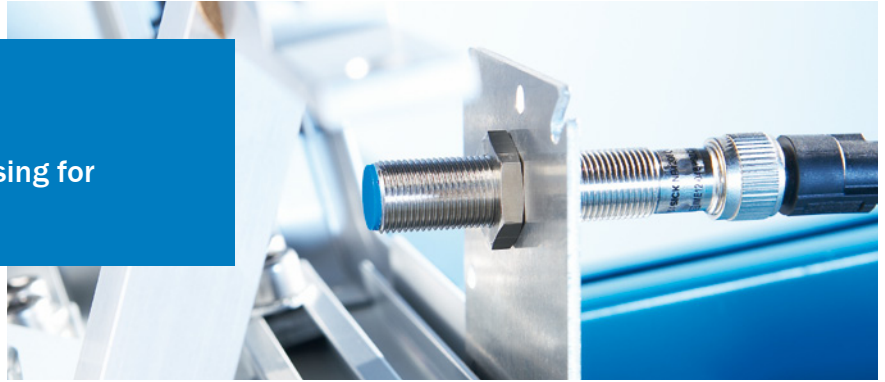

C



Product description

SICK's inductive sensors offer precise detection, less downtime and a long service life. The inductive M12 sensors pack high technology into the smallest of spaces. The integrated ASIC chip enables digital adjustment after the end of the manufacturing process. The ASIC ensures highly precise switching points and very high repeatability of values – for any

number of production runs. IME sensors are completely encapsulated with hot melt technology, which increases these sensors' life under shock and vibration. The customer benefits from high position accuracy in the machine and long-term reliability.

At a glance

- Size M12
- DC 3-/4-wire
- Expanded sensing range of up to 8 mm
- IP 67 enclosure rating
- Operating temperature from -25° C to +75° C

Your benefits

- Reduced machine downtime
- Reduced mechanical damage
- Fewer maintenance costs due to longer service life
- High resistance to shock and vibrations



Additional information

Detailed technical data C-57
 Ordering information C-58
 Dimensional drawings C-60
 Connection diagram C-61
 Installation note C-62
 Recommended accessories C-62

→ www.mysick.com/en/IME12
 For more information, just enter the link or scan the QR code and get direct access to technical data, CAD design models, operating instructions, software, application examples and much more.



Detailed technical data

Features

Housing	M12 x 1
Sensing range S_n	Flush 2 mm / 4 mm
	Non-flush 4 mm / 8 mm
Assured sensing range S_a	Flush 1.62 mm / 3.24 mm
	Non-flush 3.24 mm / 6.48 mm
Installation type	Flush / Non-flush
Switching frequency	2,000 Hz
Output type	NPN / PNP
Output function	NO / NC
Electrical wiring	DC 3-wire / DC 4-wire
Enclosure rating ¹⁾	IP 67

¹⁾ According to EN60529.

Mechanical / electrical

Supply voltage	10 V DC ... 30 V DC
Ripple	≤ 10 %
Voltage drop	≤ 2 V
Current consumption ¹⁾	≤ 10 mA
Time delay before availability	≤ 100 ms
Hysteresis	5 % ... 15 %
Repeatability ^{2) 3)}	≤ 2 %
Temperature drift (% of S_r)	± 10 %
EMC	According to EN 60947-5-2
Output current I_a	≤ 200 mA
Connection type	Cable, 2 m, PVC / Connector, M8 / Connector, M12
Wire-break protection	✓
Short-circuit protection	✓
Reverse polarity protection	✓
Power-up pulse protection	✓
Shock/vibration	30 g, 11 ms/10 ... 55 Hz, 1 mm
Ambient operating temperature	-25 °C ... +75 °C
Housing material	Metal, Nickel-plated brass
Housing cap material	Plastic, PA6
Tightening torque, max.	12 Nm
Reduction factor R_m	The values are reference values which may vary
Carbon steel St37 (Fe)	1
Stainless steel (V2A, 304)	0.8
Aluminum (Al)	0.45
Copper (Cu)	0.4
Brass (Br)	0.4

¹⁾ Without load.

²⁾ U_b and T_a constant.

³⁾ Of S_r .

Ordering information

Sensing range S_n : 2 mm

Installation	Output function	Output type	Connection	Housing	Connection diagram	Model name	Part no.
Flush	NO	PNP	Cable, 3-wire, 2 m, PVC	Short-body housing	Cd-001	IME12-02BPSZW2K	1040733
				Standard	Cd-001	IME12-02BPSZW2S	1040734
		PNP	Connector M12, 4-pin	Short-body housing	Cd-007	IME12-02BPSZC0K	1040731
				Standard	Cd-007	IME12-02BPSZC0S	1040732
		NPN	Cable, 3-wire, 2 m, PVC	Short-body housing	Cd-001	IME12-02BNSZW2K	1040741
				Standard	Cd-001	IME12-02BNSZW2S	1040742
	NPN	Connector M12, 4-pin	Short-body housing	Cd-007	IME12-02BNSZC0K	1040739	
			Standard	Cd-007	IME12-02BNSZC0S	1040740	
	NC	PNP	Cable, 3-wire, 2 m, PVC	Short-body housing	Cd-003	IME12-02BPOZW2K	1040737
				Standard	Cd-003	IME12-02BPOZW2S	1040738
		PNP	Connector M12, 4-pin	Short-body housing	Cd-008	IME12-02BPOZC0K	1040735
				Standard	Cd-008	IME12-02BPOZC0S	1040736
		NPN	Cable, 3-wire, 2 m, PVC	Short-body housing	Cd-003	IME12-02BNOZW2K	1040745
				Standard	Cd-003	IME12-02BNOZW2S	1040746
		NPN	Connector M12, 4-pin	Short-body housing	Cd-008	IME12-02BNOZC0K	1040744
				Standard	Cd-008	IME12-02BNOZC0S	1040743

Sensing range S_n : 4 mm

Installation	Output function	Output type	Connection	Housing	Connection diagram	Model name	Part no.
Flush	NO	PNP	Cable, 3-wire, 2 m, PVC	Short-body housing	Cd-001	IME12-04BPSZW2K	1040765
				Standard	Cd-001	IME12-04BPSZW2S	1040766
		PNP	Connector M8, 3-pin	Short-body housing	Cd-002	IME12-04BPSZT0K	1042973
				Connector M12, 4-pin	Short-body housing	Cd-007	IME12-04BPSZC0K
		PNP	Connector M12, 4-pin	Standard	Cd-007	IME12-04BPSZC0S	1040764
				NPN	Cable, 3-wire, 2 m, PVC	Short-body housing	Cd-001
	Standard	Cd-001	IME12-04BNSZW2S			1040774	
	NPN	Connector M12, 4-pin	Short-body housing	Cd-007	IME12-04BNSZC0K	1040771	
			Standard	Cd-007	IME12-04BNSZC0S	1040772	
	NC	PNP	Cable, 3-wire, 2 m, PVC	Short-body housing	Cd-003	IME12-04BPOZW2K	1040769
				Standard	Cd-003	IME12-04BPOZW2S	1040770
		PNP	Connector M12, 4-pin	Short-body housing	Cd-008	IME12-04BPOZC0K	1040767
				Standard	Cd-008	IME12-04BPOZC0S	1040768
		NPN	Cable, 3-wire, 2 m, PVC	Short-body housing	Cd-003	IME12-04BNOZW2K	1040777
				Standard	Cd-003	IME12-04BNOZW2S	1040778
	NPN	Connector M12, 4-pin	Short-body housing	Cd-008	IME12-04BNOZC0K	1040775	
Standard			Cd-008	IME12-04BNOZC0S	1040776		
Complementary	PNP	Cable, 4-wire, 2 m, PVC	Short-body housing	Cd-005	IME12-04BPPZW2K	1056423	

Installation	Output function	Output type	Connection	Housing	Connection diagram	Model name	Part no.
Non-flush	NO	PNP	Cable, 3-wire, 2 m, PVC	Short-body housing	Cd-001	IME12-04NPSZW2K	1040749
				Standard	Cd-001	IME12-04NPSZW2S	1040750
		PNP	Connector M12, 4-pin	Short-body housing	Cd-007	IME12-04NPSZC0K	1040747
				Standard	Cd-007	IME12-04NPSZC0S	1040748
		NPN	Cable, 3-wire, 2 m, PVC	Short-body housing	Cd-001	IME12-04NNSZW2K	1040758
				Standard	Cd-001	IME12-04NNSZW2S	1040757
	NPN	Connector M12, 4-pin	Short-body housing	Cd-007	IME12-04NNSZC0K	1040755	
			Standard	Cd-007	IME12-04NNSZC0S	1040756	
	NC	PNP	Cable, 3-wire, 2 m, PVC	Short-body housing	Cd-003	IME12-04NPOZW2K	1040753
				Standard	Cd-003	IME12-04NPOZW2S	1040754
		PNP	Connector M12, 4-pin	Short-body housing	Cd-008	IME12-04NPOZC0K	1040751
				Standard	Cd-008	IME12-04NPOZC0S	1040752
		NPN	Cable, 3-wire, 2 m, PVC	Short-body housing	Cd-003	IME12-04NNOZW2K	1040761
				Standard	Cd-003	IME12-04NNOZW2S	1040762
	NPN	Connector M12, 4-pin	Short-body housing	Cd-008	IME12-04NNOZC0K	1040759	
			Standard	Cd-008	IME12-04NNOZC0S	1040760	
	Complementary	PNP	Connector M12, 4-pin	Short-body housing	Cd-006	IME12-04NPPZC0K	1043660

Sensing range S_n : 8 mm

Installation	Output function	Output type	Connection	Housing	Connection diagram	Model name	Part no.
Non-flush	NO	PNP	Cable, 3-wire, 2 m, PVC	Short-body housing	Cd-001	IME12-08NPSZW2K	1040781
				Standard	Cd-001	IME12-08NPSZW2S	1040782
		PNP	Connector M12, 4-pin	Short-body housing	Cd-007	IME12-08NPSZC0K	1040779
				Standard	Cd-007	IME12-08NPSZC0S	1040780
		NPN	Cable, 3-wire, 2 m, PVC	Short-body housing	Cd-001	IME12-08NNSZW2K	1040789
				Standard	Cd-001	IME12-08NNSZW2S	1040790
	NPN	Connector M12, 4-pin	Short-body housing	Cd-007	IME12-08NNSZC0K	1040787	
			Standard	Cd-007	IME12-08NNSZC0S	1040788	
	NC	PNP	Cable, 3-wire, 2 m, PVC	Short-body housing	Cd-003	IME12-08NPOZW2K	1040785
				Standard	Cd-003	IME12-08NPOZW2S	1040786
		PNP	Connector M12, 4-pin	Short-body housing	Cd-008	IME12-08NPOZC0K	1040783
				Standard	Cd-008	IME12-08NPOZC0S	1040784
		NPN	Cable, 3-wire, 2 m, PVC	Short-body housing	Cd-003	IME12-08NNOZW2K	1040792
				Standard	Cd-003	IME12-08NNOZW2S	1040793
	NPN	Connector M12, 4-pin	Standard	Cd-008	IME12-08NNOZC0S	1040826	
			Short-body housing	Cd-008	IME12-08NNOZC0K	1040791	

Dimensional drawings

IME12-xxBxxxW2K,
flush, cable, short-body housing

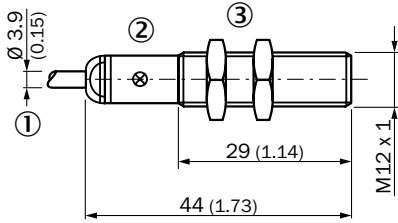

All dimensions in mm (inch)

- ① Connection
- ② LED indicator
- ③ Fastening nuts (2 x); width across 17, metal

IME12-xxBxxxW2S,
flush, cable, standard

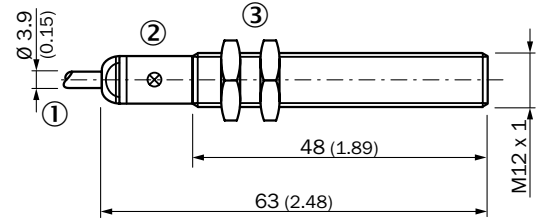

All dimensions in mm (inch)

- ① Connection
- ② LED indicator
- ③ Fastening nuts (2 x); width across 17, metal

C

IME12-xxBxxxC0K,
flush, connector, short-body housing

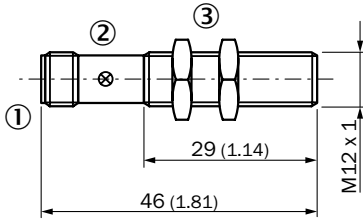

All dimensions in mm (inch)

- ① Connection
- ② LED indicator
- ③ Fastening nuts (2 x); width across 17, metal

IME12-xxBxxxC0S,
flush, connector, standard

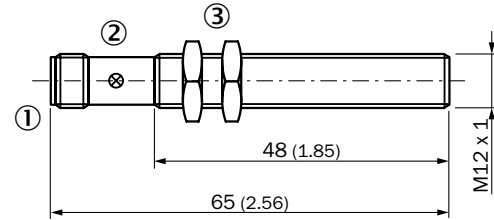

All dimensions in mm (inch)

- ① Connection
- ② LED indicator
- ③ Fastening nuts (2 x); width across 17, metal

IME12-xxNxxxW2K,
non-flush, cable, short-body housing

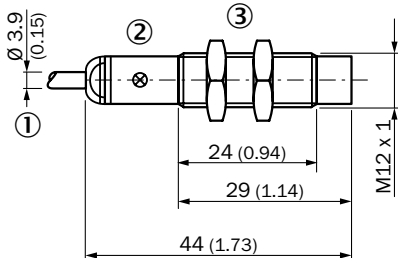

All dimensions in mm (inch)

- ① Connection
- ② LED indicator
- ③ Fastening nuts (2 x); width across 17, metal

IME12-xxNxxxW2S,
non-flush, cable, standard

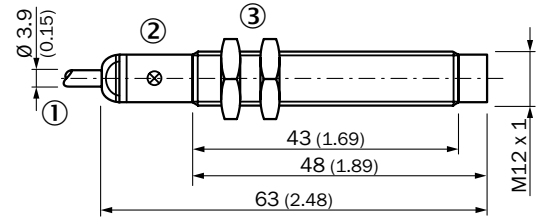

All dimensions in mm (inch)

- ① Connection
- ② LED indicator
- ③ Fastening nuts (2 x); width across 17, metal

**IME12-xxNxxxCOK,
non-flush, connector, short-body housing**

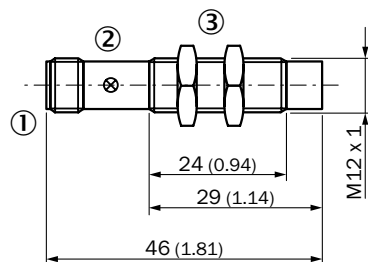

All dimensions in mm (inch)

- ① Connection
- ② LED indicator
- ③ Fastening nuts (2 x); width across 17, metal

**IME12-xxNxxxCOS,
non-flush, connector, standard**

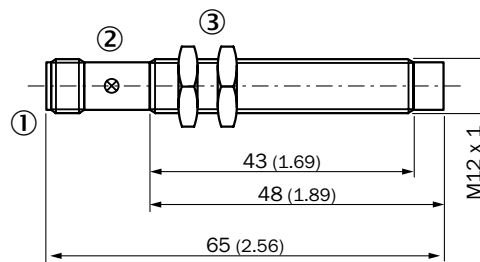

All dimensions in mm (inch)

- ① Connection
- ② LED indicator
- ③ Fastening nuts (2 x); width across 17, metal

Connection diagram

Cd-001

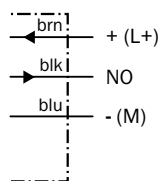

Cd-002

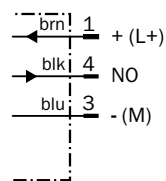

Cd-003

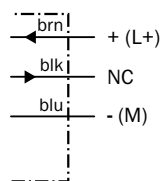

Cd-005

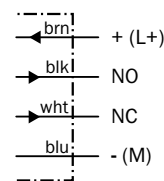

Cd-006

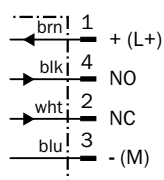

Cd-007

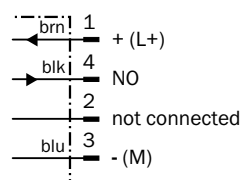

Cd-008

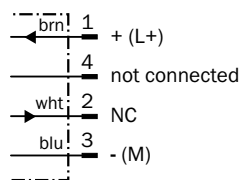

C

Installation note

Flush installation

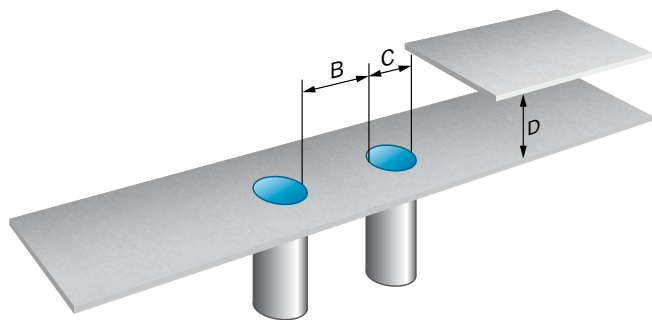

Non-flush installation

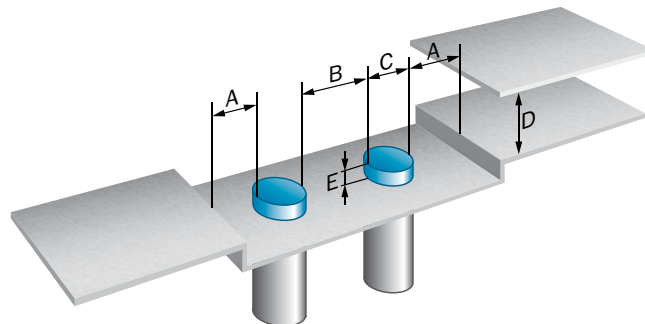

Opposite installation

C

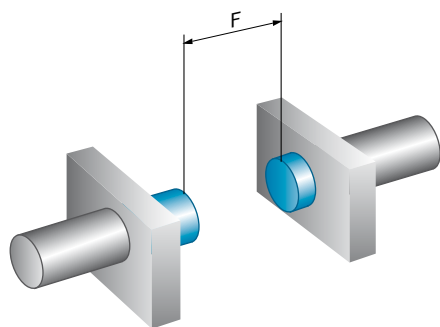



	Installation type	Sensing range Sn	A	B	C	D	E	F
IME12-02Bxxxxxx	Flush	2 mm	-	12 mm	12 mm	6 mm	-	16 mm
IME12-04Bxxxxxx	Flush	4 mm	-	24 mm	12 mm	12 mm	-	32 mm
IME12-04Nxxxxxx	Non-flush	4 mm	12 mm	24 mm	12 mm	12 mm	8 mm	32 mm
IME12-08Nxxxxxx	Non-flush	8 mm	12 mm	24 mm	12 mm	24 mm	16 mm	64 mm

Recommended accessories

Mounting brackets





- Accessory type: Mounting brackets
- Material: Steel, zinc coated

Figure	Thread size	Configuration	Model name	Part no.
	M12	Straight	BEF-WG-M12	5321869
		Right angle	BEF-WN-M12	5308447

Cordsets and connectors

Connector M12, 4-pin





- **Connector type:** Female connector
- **Enclosure rating:** IP 67

Figure	Configuration	Jacket material	Cable length	Model name	Part no.
	Straight	PVC	2 m	DOL-1204-G02M	6009382
			5 m	DOL-1204-G05M	6009866
			10 m	DOL-1204-G10M	6010543
	Right angle	PVC	2 m	DOL-1204-W02M	6009383
			5 m	DOL-1204-W05M	6009867
			10 m	DOL-1204-W10M	6010541
	Straight	PBT	-	DOS-1204-G	6007302
	Right angle	PBT	-	DOS-1204-W	6007303

C

Connector M8, 3-pin

- **Connector type:** Female connector
- **Enclosure rating:** IP 67

Figure	Configuration	Jacket material	Cable length	Model name	Part no.
	Straight	PVC	2 m	DOL-0803-G02M	6010785
			5 m	DOL-0803-G05M	6022009
			10 m	DOL-0803-G10M	6022011
	Right angle	PVC	2 m	DOL-0803-W02M	6008489
			5 m	DOL-0803-W05M	6022010
			10 m	DOL-0803-W10M	6022012
	Straight	PBT	-	DOS-0803-G	7902077
	Right angle	PBT	-	DOS-0803-W	7902078

Terminal and alignment brackets

- **Accessory type:** Terminal brackets
- **Material:** Plastic (PA12), glass-fiber reinforced

Figure	Description	Model name	Part no.
	Terminal bracket M12, without fixed stop	BEF-KH-M12	2051479
	Terminal bracket M12, with fixed stop	BEF-KHF-M12	2051480

→ For additional accessories, please see page G-255

4-wire multi-function sensors in M12 housing

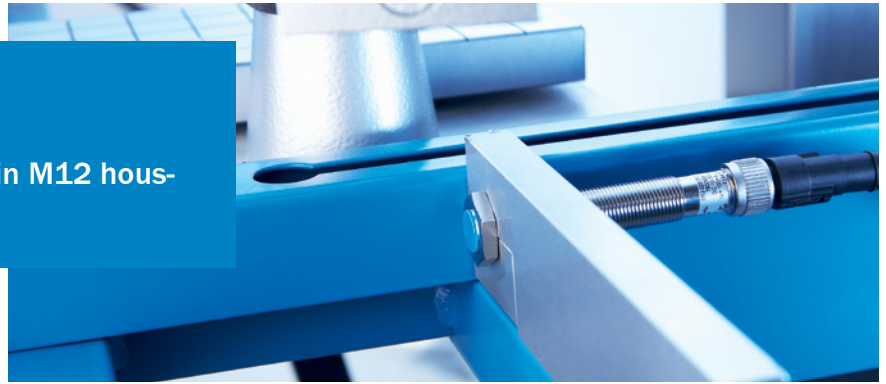

Product description

Whether PNP, NPN, NC or NO function is required – multi-function sensors in M12 housing always offer a solution. A simple adjustment of the wiring provides 4 functions in one single sen-

sor, drastically reducing the number of variants. Thanks to this feature, the right sensor is always available with high reliability guaranteed.

At a glance

- Size M12
- Free configurable output
- DC 4-wire
- PNP or NPN and NC or NO function in one sensor
- Expanded sensing range of up to 4 mm
- IP 67 enclosure rating
- Operating temperature from -25° C to +75° C

Your benefits

- Low storage costs
- More convenient with a reduction in variants
- High reliability
- High resistance to shock and vibrations



Additional information

Detailed technical data C-65
 Ordering information C-66
 Dimensional drawings C-66
 Connection diagram C-67
 Installation note C-67
 Recommended accessories C-68

→ www.mysick.com/en/IM12
 For more information, just enter the link or scan the QR code and get direct access to technical data, CAD design models, operating instructions, software, application examples and much more.



C

Detailed technical data

Features

Housing	M12 x 1
Sensing range S_n	Flush 2 mm
	Non-flush 4 mm
Assured sensing range S_a	Flush 1.62 mm
	Non-flush 3.24 mm
Installation type	Flush / non-flush
Switching frequency	1,000 Hz
Output type	PNP or NPN, wire configurable
Output function	NC or NO, wire configurable
Electrical wiring	DC 4-wire
Enclosure rating ¹⁾	IP 67

¹⁾ According to EN60529.

C

Mechanical / electrical

Supply voltage	10 V DC ... 30 V DC
Ripple ^{1) 1)}	≤ 10 %
Voltage drop ²⁾	≤ 1.2 V
Current consumption ³⁾	≤ 30 mA
Time delay before availability	≤ 250 ms
Hysteresis	2 % ... 10 %
Repeatability ^{4) 5)}	≤ 5 %
Temperature drift (% of S_r)	± 10 %
EMC	According to EN 60947-5-2
Output current I_a	≤ 100 mA
Connection type	Connector, M12 / Cable, 2 m, PVC
Short-circuit protection	✓
Reverse polarity protection	✓
Power-up pulse protection	✓
Shock/vibration	30 g, 11 ms/10 ... 55 Hz, 1 mm
Ambient operating temperature	-25 °C ... +70 °C
Housing material	Metal, Nickel-plated brass
Housing cap material	Plastic
Tightening torque, max.	≤ 10 Nm
Reduction factor R_m	The values are reference values which may vary
Stainless steel (V2A, 304)	0.8
Aluminum (Al)	0.45
Copper (Cu)	0.4

¹⁾ Of V_s .

²⁾ At I_a max.

³⁾ Without load.

⁴⁾ U_b and T_a constant.

⁵⁾ Of S_r .

Ordering information

DC 4-wire

- **Housing:** M12 x 1
- **Output function:** NC or NO
- **Output type:** PNP or NPN

Sensing range S_n	Installation type	Connection	Connection diagram	Model name	Part no.
2 mm	Flush	Connector M12, 4-pin	Cd-027	IM12-02BCP-ZC1	7902928
		Cable, 4-wire, 2 m, PVC	Cd-026	IM12-02BCP-ZW1	7902927
4 mm	Non-flush	Connector M12, 4-pin	Cd-027	IM12-04NCP-ZC1	7902930
		Cable, 4-wire, 2 m, PVC	Cd-026	IM12-04NCP-ZW1	7902929

Dimensional drawings

C

IM12-02BCP-ZC1,
flush, connector

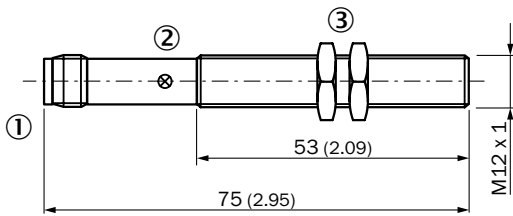

All dimensions in mm (inch)

- ① Connection
- ② LED indicator
- ③ Fastening nuts (2 x); width across 17, metal

IM12-02BCP-ZW1,
flush, cable

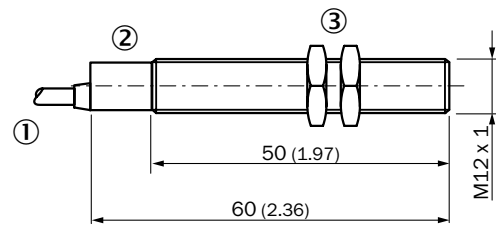

All dimensions in mm (inch)

- ① Connection
- ② LED indicator
- ③ Fastening nuts (2 x); width across 17, metal

IM12-04NCP-ZC1,
non-flush, connector

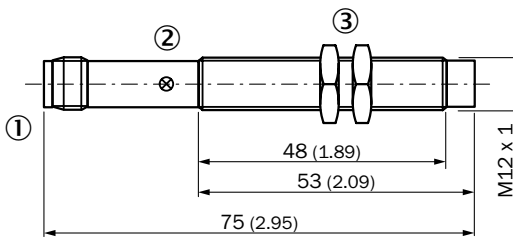

All dimensions in mm (inch)

- ① Connection
- ② LED indicator
- ③ Fastening nuts (2 x); width across 17, metal

IM12-04NCP-ZW1,
non-flush, cable

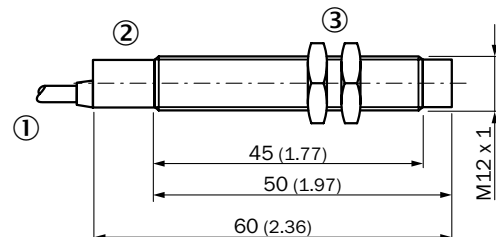

All dimensions in mm (inch)

- ① Connection
- ② LED indicator
- ③ Fastening nuts (2 x); width across 17, metal

Connection diagram

Cd-026

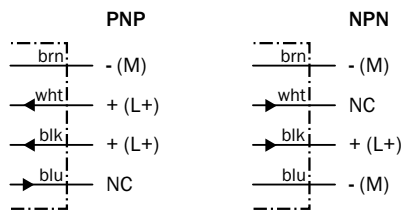
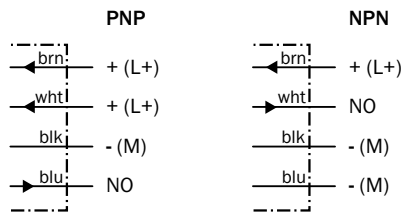

Cd-027

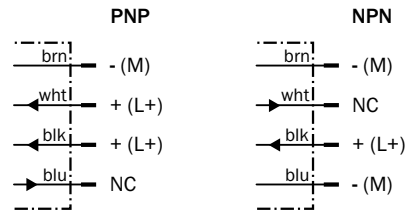
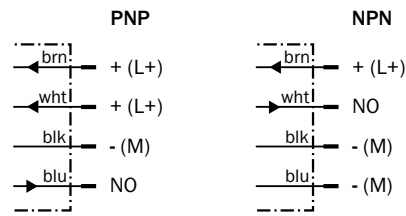

Installation note

Flush installation

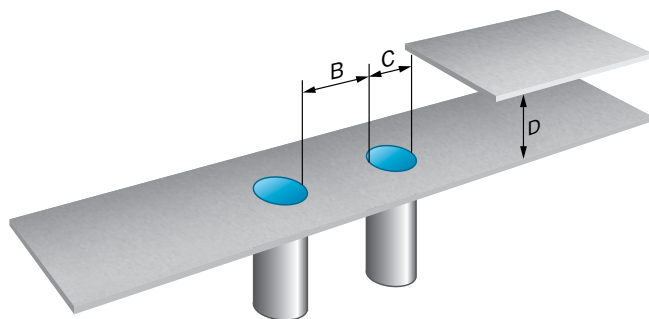

Non-flush installation

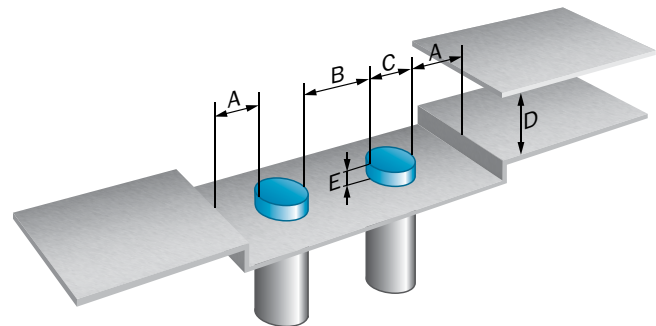

Opposite installation

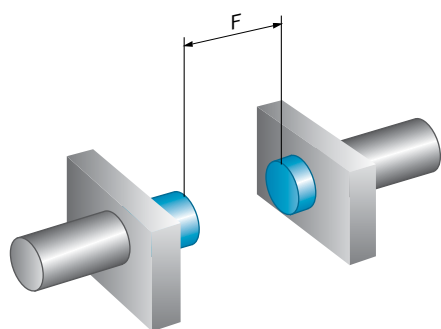



	Installation type	A	B	C	D	E	F
IM12-02Bxx-xxx	Flush	6 mm	12 mm	12 mm	6 mm	0 mm	16 mm
IM12-04Nxx-xxx	Non-flush	12 mm	24 mm	12 mm	12 mm	8 mm	32 mm

Recommended accessories





Mounting brackets

- **Accessory type:** Mounting brackets
- **Material:** Steel, zinc coated

Figure	Thread size	Configuration	Model name	Part no.
	M12	Straight	BEF-WG-M12	5321869
		Right angle	BEF-WN-M12	5308447

Cordsets and connectors

Connector M12, 4-pin

Figure	Connector type	Enclosure rating	Configuration	Jacket material	Cable length	Model name	Part no.
	Female connector	IP 67	Straight	PVC	2 m	DOL-1204-G02M	6009382
					5 m	DOL-1204-G05M	6009866
		IP 68	Right angle	PVC	2 m	DOL-1204-L02M	6027945
					5 m	DOL-1204-L05M	6027944
		IP 67	Right angle	PVC	2 m	DOL-1204-W02M	6009383
					5 m	DOL-1204-W05M	6009867
		IP 67	Straight	PBT	-	DOS-1204-G	6007302
					Right angle	PBT	-

Terminal and alignment brackets

- **Accessory type:** Terminal brackets
- **Material:** Plastic (PA12), glass-fiber reinforced

Figure	Description	Model name	Part no.
	Terminal bracket M12, without fixed stop	BEF-KH-M12	2051479
	Terminal bracket M12, with fixed stop	BEF-KHF-M12	2051480

→ For additional accessories, please see page G-255

C

2-wire sensors in M18 housing for industrial use



Product description

The SICK family of inductive AC and DC 2-wire sensors offers a high level of reliability, robustness and a long service life. Low power consumption, reduced wiring requirement and integrated, easy handling of the 2-wire sensors make this sensor family extremely popular. As

with conventional, mechanical position switches, setting up a series connection is easy to do. This ensures that modern, non-contact inductive 2-wire sensors can be used in existing applications.

At a glance

- Size M18
- AC and DC 2-wire
- Expanded sensing range of up to 8 mm
- Operating temperature from -25° C to +80° C
- IP 67 enclosure rating

Your benefits

- Reduced wiring requirement
- Quick and easy to install
- Low power consumption
- Reduced machine downtime
- Fewer maintenance costs due to longer service life
- High resistance to shock and vibrations



Additional information

Detailed technical data.....C-71
 Ordering information.....C-72
 Dimensional drawings.....C-73
 Connection diagram.....C-74
 Installation note.....C-74
 Recommended accessories.....C-75

→ www.mysick.com/en/IM18

For more information, just enter the link or scan the QR code and get direct access to technical data, CAD design models, operating instructions, software, application examples and much more.



Detailed technical data

Features

	DC 2-wire	AC/DC 2-wire
Housing	M18 x 1	
Sensing range S_n	Flush	5 mm
	Non-flush	8 mm
Assured sensing range S_a	Flush	4.05 mm
	Non-flush	6.48 mm
Installation type	Flush / Non-flush	
Switching frequency	300 Hz	25 Hz ¹⁾ / 100 Hz ²⁾
Output function	NO / NC	
Electrical wiring	DC 2-wire	AC/DC 2-wire
Enclosure rating ³⁾	IP 67	

¹⁾ AC.

²⁾ DC.

³⁾ According to EN60529.

C

Mechanical / electrical

	DC 2-wire	AC/DC 2-wire
Supply voltage	10 V DC ... 30 V DC	20 V AC/DC ... 250 V AC/DC
Ripple	≤ 10 %	–
Voltage drop	≤ 2.8 V ¹⁾	≤ 6.5 V AC, ≤ 6 V DC
Time delay before availability	≤ 50 ms	≤ 8 ms
Hysteresis	2 % ... 10 %	1 % ... 15 %
Repeatability ²⁾ ³⁾	≤ 2 %	≤ 10 %
Temperature drift (% of S_p)	± 10 %	
EMC	According to EN 60947-5-2	
Output current I_a	≤ 100 mA	≤ 350 mA, AC (+50 °C) ≤ 250 mA, AC (+80 °C) ≤ 100 mA, DC
Off-state current	≤ 0.8 mA	≤ 2.5 mA (AC 250 V) ≤ 1.3 mA (AC 110 V) ≤ 0.8 mA (DC 24 V)
Load resistance, min.	≥ 3 mA	≥ 5 mA
Short-time withstand current	–	2.2 A ⁴⁾
Connection type	Connector, M12 / Cable, 2 m, PVC	Cable, 2 m, PUR-PVC
Short-circuit protection	✓	–
Reverse polarity protection	✓	–
Power-up pulse protection	–	✓
Shock/vibration	30 g, 11 ms/10 ... 55 Hz, 1 mm	
Ambient operating temperature	–25 °C ... +70 °C	–25 °C ... +80 °C
Housing material	Metal, Nickel-plated brass	
Housing cap material	Plastic, PBT	Plastic, PC
Tightening torque, max.	30 Nm	35 Nm
Protection class	–	II

	DC 2-wire	AC/DC 2-wire
Reduction factor RM	The values are reference values which may vary	
Stainless steel (V2A, 304)		
Flush	0.86	0.8
Non-flush	0.77	0.8
Aluminum (Al)		
Flush	0.48	0.45
Non-flush	0.53	0.45
Copper (Cu)		
Flush	0.4	
Non-flush	0.45	0.4
Brass (Br)		
Flush	0.72	-
Non-flush	0.56	-

¹⁾ At I_a max.

²⁾ U_b and T_a constant.

³⁾ Of Sr.

⁴⁾ 20 ms / 0.5 Hz.

C

Ordering information

DC 2-wire

- Housing: M18 x 1

Sensing range S_n	Installation	Output function	Connection	Connection diagram	Model name	Part no.
5 mm	Flush	NO	Connector M12, 4-pin	Cd-015	IM18-05BDS-ZC1	6020320
			Cable, 2-wire, 2 m, PVC	Cd-012	IM18-05BDS-ZW1	6020318
8 mm	Non-flush	NO	Connector M12, 4-pin	Cd-015	IM18-05BD0-ZC1	6020321
			Cable, 2-wire, 2 m, PVC	Cd-012	IM18-08NDS-ZC1	6020324
8 mm	Non-flush	NO	Connector M12, 4-pin	Cd-015	IM18-08NDS-ZC1	6020324
			Cable, 2-wire, 2 m, PVC	Cd-012	IM18-08NDS-ZW1	6020322

AC/DC 2-wire

- Housing: M18 x 1

Sensing range S_n	Installation	Output function	Connection	Connection diagram	Model name	Part no.
5 mm	Flush	NO	Cable, 2-wire, 2 m, PUR-PVC	Cd-020	IM18-05BUS-ZU0	7902122
		NC	Cable, 2-wire, 2 m, PUR-PVC	Cd-039	IM18-05BU0-ZU0	7902123
8 mm	Non-flush	NO	Cable, 2-wire, 2 m, PUR-PVC	Cd-020	IM18-08NUS-ZU0	7902124
		NC	Cable, 2-wire, 2 m, PUR-PVC	Cd-039	IM18-08NU0-ZU0	7902125

Dimensional drawings

IM18-xxBxx-xC1, DC, flush, connector

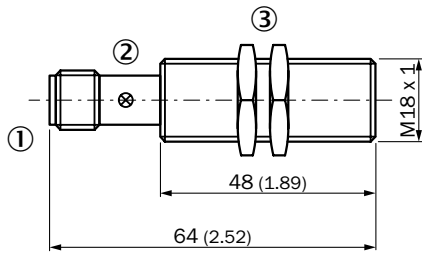

All dimensions in mm (inch)

- ① Connection
- ② LED indicator
- ③ Fastening nuts (2 x); 24 mm hex, metal

IM18-xxBxx-xW1, DC, flush, cable

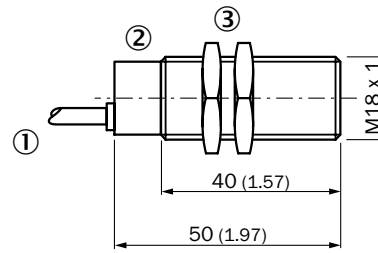

All dimensions in mm (inch)

- ① Connection
- ② LED indicator
- ③ Fastening nuts (2 x); 24 mm hex, metal

IM18-xxNxx-xC1, DC, non-flush, connector

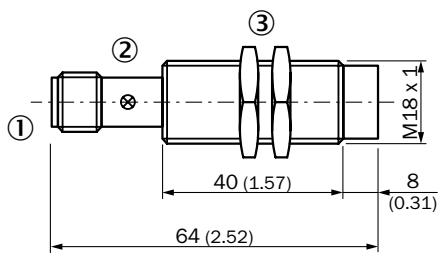

All dimensions in mm (inch)

- ① Connection
- ② LED indicator
- ③ Fastening nuts (2 x); 24 mm hex, metal

IM18-xxNxx-xW1, DC, non-flush, cable

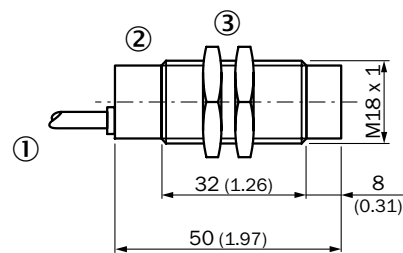

All dimensions in mm (inch)

- ① Connection
- ② LED indicator
- ③ Fastening nuts (2 x); 24 mm hex, metal

IM18-xxBxx-xU0, AC/DC, flush, cable

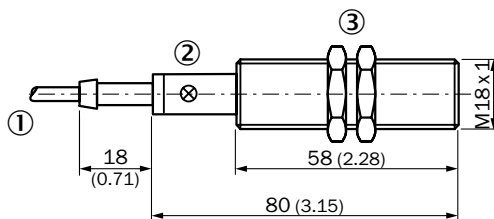

All dimensions in mm (inch)

- ① Connection
- ② LED indicator
- ③ Fastening nuts (2 x); 24 mm hex, metal

IM18-xxNxx-xU0, AC/DC, non-flush, cable

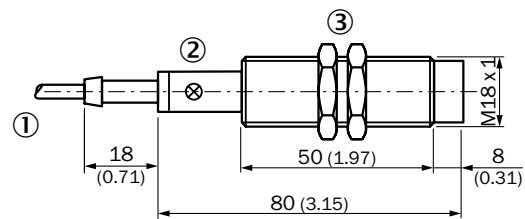

All dimensions in mm (inch)

- ① Connection
- ② LED indicator
- ③ Fastening nuts (2 x); 24 mm hex, metal

C

Connection diagram

Cd-012

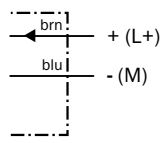

Cd-015

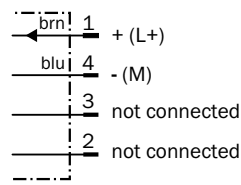

Cd-020

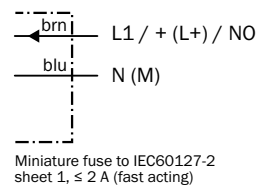

Cd-039

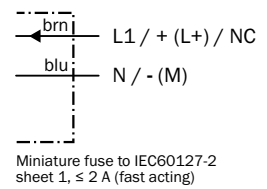

Installation note

Flush installation

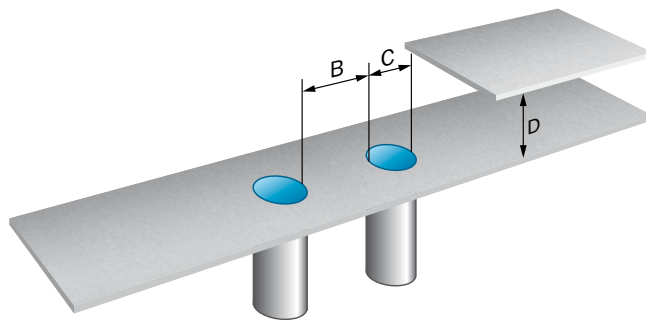

Non-flush installation

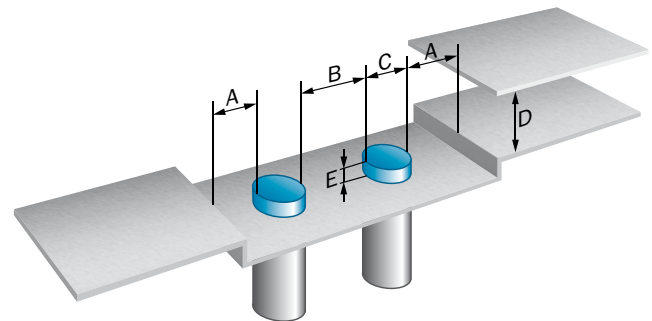

Opposite installation

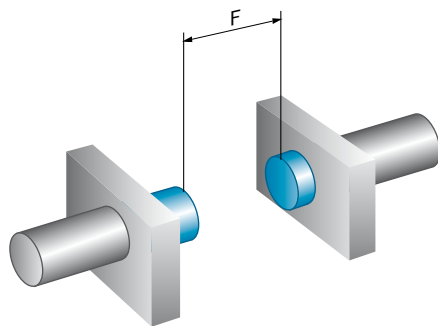



	Installation type	Electrical wiring	A	B	C	D	E	F
IM18-05BUx-xxx	Flush	DC 2-wire	0 mm	18 mm	18 mm	15 mm	0 mm	40 mm
IM18-05BDx-xxx	Flush	AC/DC 2-wire	9 mm	18 mm	18 mm	15 mm	3.6 mm	40 mm
IM18-08NUx-xxx	Non-flush	DC 2-wire	18 mm	36 mm	18 mm	24 mm	16 mm	64 mm
IM18-08NDx-xxx	Non-flush	AC/DC 2-wire	18 mm	36 mm	18 mm	24 mm	16 mm	64 mm

Recommended accessories

Mounting brackets/plates







- **Accessory type:** Mounting brackets
- **Material:** Steel, zinc coated

Figure	Thread size	Configuration	Model name	Part no.
	M18	Straight	BEF-WG-M18	5321870
		Right angle	BEF-WN-M18	5308446

Cordsets and connectors

Connector M12, 4-pin

- **Enclosure rating:** IP 67

Figure	Connector type	Configuration	Jacket material	Cable length	Model name	Part no.		
	Female connector	Straight	PVC	2 m	DOL-1204-G02M	6009382		
				5 m	DOL-1204-G05M	6009866		
		Right angle	PVC	2 m	DOL-1204-W02M	6009383		
				5 m	DOL-1204-W05M	6009867		
		Straight	PBT	-	-	DOS-1204-G	6007302	
					Right angle	PBT	-	DOS-1204-W
		Male connector	Straight	PBT	-	-	STE-1204-G	6009932
						Right angle	PBT	-

Terminal and alignment brackets

Figure	Description	Material	Model name	Part no.
	Terminal bracket M18, without fixed stop	Plastic (PA12), glass-fiber reinforced	BEF-KH-M18	2051481

→ For additional accessories, please see page G-255

3-/4-wire sensors in M18 housing for industrial use

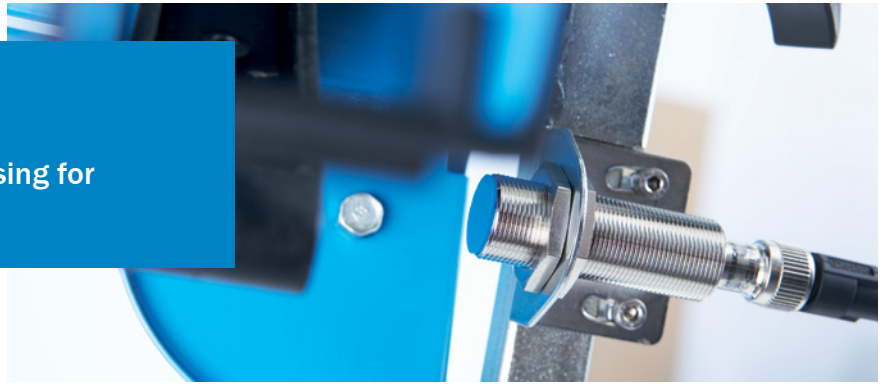

Product description

SICK's inductive sensors offer precise detection, less downtime and a long service life. The inductive M18 sensors pack high technology into the smallest of spaces. The integrated ASIC chip enables digital adjustment after the end of the manufacturing process. The ASIC ensures highly precise switching points and very high repeatability of values – for any

number of production runs. IME sensors are completely encapsulated with hot melt technology, which increases these sensors' life under shock and vibration. The customer benefits from high position accuracy in the machine and long-term reliability.

At a glance

- Size M18
- DC 3-/4-wire
- Expanded sensing range of up to 12 mm
- IP 67 enclosure rating
- Operating temperature from -25° C to +75° C

Your benefits

- Reduced machine downtime
- Reduced mechanical damage
- Fewer maintenance costs due to longer service life
- High resistance to shock and vibrations



Additional information

Detailed technical data C-77
 Ordering information C-78
 Dimensional drawings C-80
 Connection diagram C-81
 Installation note C-82
 Recommended accessories C-82

→ www.mysick.com/en/IME18
 For more information, just enter the link or scan the QR code and get direct access to technical data, CAD design models, operating instructions, software, application examples and much more.



C

Detailed technical data

Features

Housing	M18 x 1
Sensing range S_n	Flush 5 mm / 8 mm
	Non-flush 5 mm / 8 mm
Assured sensing range S_a	Flush 4.05 mm / 6.48 mm
	Non-flush 4.05 mm / 6.48 mm
Installation type	Flush / non-flush
Switching frequency	1,000 Hz
Output type	NPN / PNP
Output function	NO / NC / Complementary
Electrical wiring	DC 3-wire / DC 4-wire
Enclosure rating ¹⁾	IP 67

¹⁾ According to EN60529.

C

Mechanical / electrical

Supply voltage	10 V DC ... 30 V DC
Ripple	≤ 10 %
Voltage drop	≤ 2 V
Current consumption ^{1) 1)}	≤ 10 mA
Time delay before availability	≤ 100 ms
Hysteresis	5 % ... 15 %
Repeatability ^{2) 3)}	≤ 2 %
Temperature drift (% of S_r)	± 10 %
EMC	According to EN 60947-5-2
Output current I_a	≤ 200 mA
Connection type	Cable, 2 m, PVC / Connector, M12
Wire-break protection	✓
Short-circuit protection	✓
Reverse polarity protection	✓
Power-up pulse protection	✓
Shock/vibration	30 g, 11 ms/10 ... 55 Hz, 1 mm
Ambient operating temperature	-25 °C ... +75 °C
Housing material	Metal, Nickel-plated brass
Housing cap material	Plastic, PA6
Tightening torque, max.	40 Nm
Reduction factor R_m	The values are reference values which may vary
Carbon steel St37 (Fe)	1
Stainless steel (V2A, 304)	0.8
Aluminum (Al)	0.45
Copper (Cu)	0.4
Brass (Br)	0.4

¹⁾ Without load.

²⁾ U_b and T_a constant.

³⁾ Of S_r .

Ordering information

Sensing range S_n : 5 mm

- Housing: M18 x 1

Installation type	Output function	Output type	Connection	Housing	Connection diagram	Model name	Part no.
Flush	NO	NPN	Cable, 3-wire, 2 m, PVC	Short-body housing	Cd-001	IME18-05BNSZW2K	1040943
				Standard	Cd-001	IME18-05BNSZW2S	1040944
			Connector M12, 4-pin	Short-body housing	Cd-007	IME18-05BNSZC0K	1040941
				Standard	Cd-007	IME18-05BNSZC0S	1040942
		PNP	Cable, 3-wire, 2 m, PVC	Short-body housing	Cd-001	IME18-05BPSZW2K	1040935
				Standard	Cd-001	IME18-05BPSZW2S	1040936
			Connector M12, 4-pin	Standard	Cd-007	IME18-05BPSZC0S	1040934
				Short-body housing	Cd-007	IME18-05BPSZC0K	1040933
	NC	NPN	Cable, 3-wire, 2 m, PVC	Short-body housing	Cd-003	IME18-05BNOZW2K	1040947
				Standard	Cd-003	IME18-05BNOZW2S	1040948
			Connector M12, 4-pin	Short-body housing	Cd-008	IME18-05BNOZC0K	1040945
				Standard	Cd-008	IME18-05BNOZC0S	1040946
		PNP	Cable, 3-wire, 2 m, PVC	Short-body housing	Cd-003	IME18-05BPOZW2K	1040939
				Standard	Cd-003	IME18-05BPOZW2S	1040940
			Connector M12, 4-pin	Short-body housing	Cd-008	IME18-05BPOZC0K	1040937
				Standard	Cd-008	IME18-05BPOZC0S	1040938
	Complementary	PNP	Connector M12, 4-pin	Standard	Cd-006	IME18-05BPPZC0S	1046743

Sensing range S_n : 8 mm

- Housing: M18 x 1

Installation type	Output function	Output type	Connection	Housing	Connection diagram	Model name	Part no.
Flush	NO	NPN	Cable, 3-wire, 2 m, PVC	Short-body housing	Cd-001	IME18-08BNSZW2K	1040975
				Standard	Cd-001	IME18-08BNSZW2S	1040976
			Connector M12, 4-pin	Short-body housing	Cd-007	IME18-08BNSZC0K	1040973
				Standard	Cd-007	IME18-08BNSZC0S	1040974
		PNP	Cable, 3-wire, 2 m, PVC	Short-body housing	Cd-001	IME18-08BPSZW2K	1040967
				Standard	Cd-001	IME18-08BPSZW2S	1040968
			Connector M12, 4-pin	Short-body housing	Cd-007	IME18-08BPSZC0K	1040965
				Standard	Cd-007	IME18-08BPSZC0S	1040966
	NC	NPN	Cable, 3-wire, 2 m, PVC	Short-body housing	Cd-003	IME18-08BNOZW2K	1040979
				Standard	Cd-003	IME18-08BNOZW2S	1040980
			Connector M12, 4-pin	Short-body housing	Cd-008	IME18-08BNOZC0K	1040977
				Standard	Cd-008	IME18-08BNOZC0S	1040978
		PNP	Cable, 3-wire, 2 m, PVC	Short-body housing	Cd-003	IME18-08BPOZW2K	1040971
				Standard	Cd-003	IME18-08BPOZW2S	1040972
			Connector M12, 4-pin	Short-body housing	Cd-008	IME18-08BPOZC0K	1040969
				Standard	Cd-008	IME18-08BPOZC0S	1040970
	Complementary	PNP	Connector M12, 4-pin	Standard	Cd-008	IME18-08BPPZC0S	1056708

Installation type	Output function	Output type	Connection	Housing	Connection diagram	Model name	Part no.
Non-flush	NO	NPN	Cable, 3-wire, 2 m, PVC	Short-body housing	Cd-001	IME18-08NNSZW2K	1040959
				Standard	Cd-001	IME18-08NNSZW2S	1040960
		Connector M12, 4-pin	Short-body housing	Cd-007	IME18-08NNSZC0K	1040957	
			Standard	Cd-007	IME18-08NNSZC0S	1040958	
		PNP	Cable, 3-wire, 2 m, PVC	Short-body housing	Cd-001	IME18-08NPSZW2K	1040951
				Standard	Cd-001	IME18-08NPSZW2S	1040952
	Connector M12, 4-pin	Short-body housing	Cd-007	IME18-08NPSZC0K	1040949		
		Standard	Cd-007	IME18-08NPSZC0S	1040950		
	NC	NPN	Cable, 3-wire, 2 m, PVC	Standard	Cd-003	IME18-08NNOZW2S	1040964
				Short-body housing	Cd-008	IME18-08NNOZC0K	1040961
		Connector M12, 4-pin	Standard	Cd-008	IME18-08NNOZC0S	1040962	
			Short-body housing	Cd-003	IME18-08NPOZW2K	1040955	
		PNP	Cable, 3-wire, 2 m, PVC	Standard	Cd-003	IME18-08NPOZW2S	1040956
				Short-body housing	Cd-008	IME18-08NPOZC0K	1040953
	Connector M12, 4-pin	Standard	Cd-008	IME18-08NPOZC0S	1040954		
	Complementary	PNP	Connector M12, 4-pin	Standard	Cd-006	IME18-08NPPZC0S	1046894

C

Sensing range S_n : 12 mm

- Housing: M18 x 1

Installation type	Output function	Output type	Connection	Housing	Connection diagram	Model name	Part no.
Non-flush	NO	NPN	Cable, 3-wire, 2 m, PVC	Short-body housing	Cd-001	IME18-12NNSZW2K	1040991
				Standard	Cd-001	IME18-12NNSZW2S	1040992
		Connector M12, 4-pin	Short-body housing	Cd-007	IME18-12NNSZC0K	1040989	
			Standard	Cd-007	IME18-12NNSZC0S	1040990	
		PNP	Cable, 3-wire, 2 m, PVC	Short-body housing	Cd-001	IME18-12NPSZW2K	1040983
				Standard	Cd-001	IME18-12NPSZW2S	1040984
	Connector M12, 4-pin	Short-body housing	Cd-007	IME18-12NPSZC0K	1040981		
		Standard	Cd-007	IME18-12NPSZC0S	1040982		
	NC	NPN	Cable, 3-wire, 2 m, PVC	Short-body housing	Cd-003	IME18-12NNOZW2K	1040995
				Standard	Cd-003	IME18-12NNOZW2S	1040996
		Connector M12, 4-pin	Short-body housing	Cd-008	IME18-12NNOZC0K	1040993	
			Standard	Cd-008	IME18-12NNOZC0S	1040994	
		PNP	Cable, 3-wire, 2 m, PVC	Short-body housing	Cd-003	IME18-12NPOZW2K	1040987
				Standard	Cd-003	IME18-12NPOZW2S	1040988
	Connector M12, 4-pin	Short-body housing	Cd-008	IME18-12NPOZC0K	1040985		
	Standard	Cd-008	IME18-12NPOZC0S	1040986			
Complementary	PNP	Connector M12, 4-pin	Standard	Cd-006	IME18-12NPPZC0S	1044127	

Dimensional drawings

IME18-xxBxxxW2K,
flush, cable, short-body housing

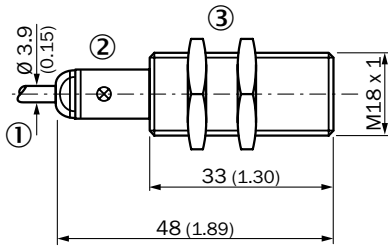

All dimensions in mm (inch)

- ① Connection
- ② LED indicator
- ③ Fastening nuts (2 x); 24 mm hex, metal

IME18-xxBxxxW2S,
flush, cable, standard

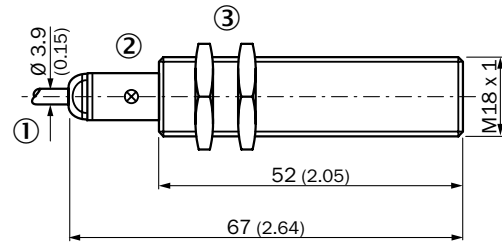

All dimensions in mm (inch)

- ① Connection
- ② LED indicator
- ③ Fastening nuts (2 x); 24 mm hex, metal

C

IME18-xxBxxxC0K,
flush, connector, short-body housing

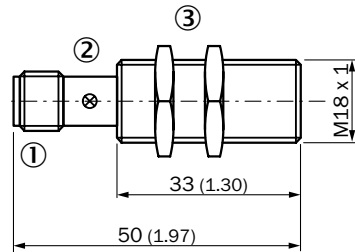

All dimensions in mm (inch)

- ① Connection
- ② LED indicator
- ③ Fastening nuts (2 x); 24 mm hex, metal

IME18-xxBxxxC0S,
flush, connector, standard

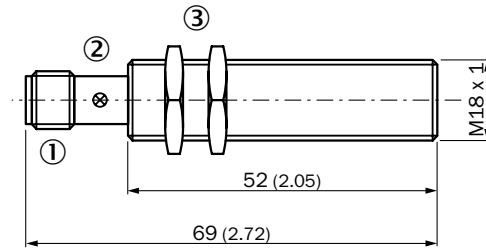

All dimensions in mm (inch)

- ① Connection
- ② LED indicator
- ③ Fastening nuts (2 x); 24 mm hex, metal

IME18-xxNxxxW2K,
non-flush, cable, short-body housing

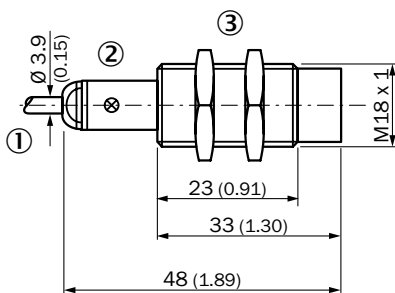

All dimensions in mm (inch)

- ① Connection
- ② LED indicator
- ③ Fastening nuts (2 x); 24 mm hex, metal

IME18-xxNxxxW2S,
non-flush, cable, standard

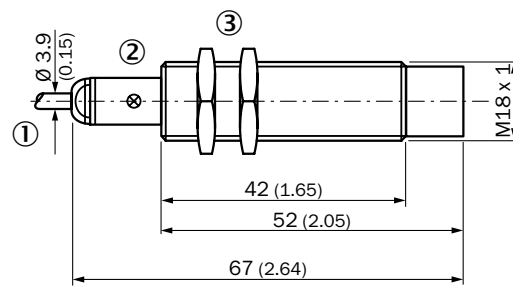

All dimensions in mm (inch)

- ① Connection
- ② LED indicator
- ③ Fastening nuts (2 x); 24 mm hex, metal

**IME18-xxNxxxCOK,
non-flush, connector, short-body housing**

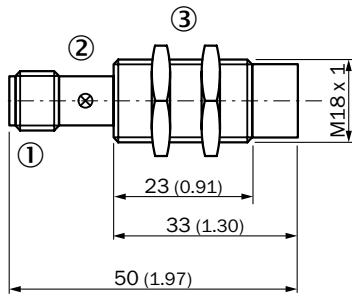

All dimensions in mm (inch)

- ① Connection
- ② LED indicator
- ③ Fastening nuts (2 x); 24 mm hex, metal

**IME18-xxNxxxCOS,
non-flush, connector, standard**

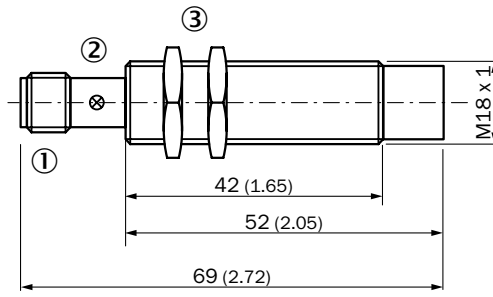

All dimensions in mm (inch)

- ① Connection
- ② LED indicator
- ③ Fastening nuts (2 x); 24 mm hex, metal

Connection diagram

Cd-001

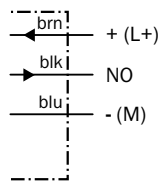

Cd-003

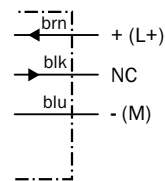

Cd-006

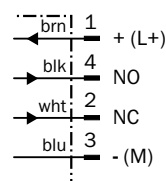

Cd-007

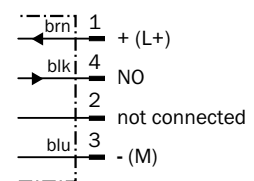

Cd-008

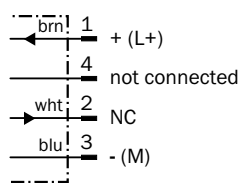

C

Installation note

Flush installation

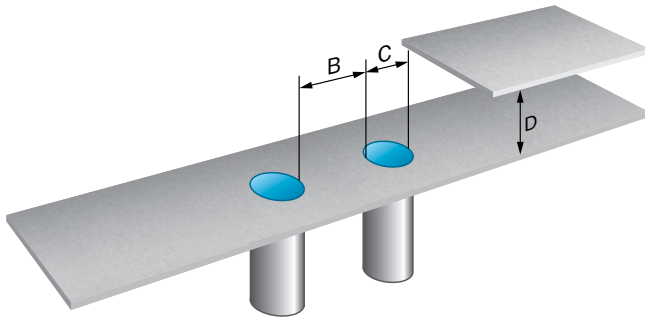

Non-flush installation

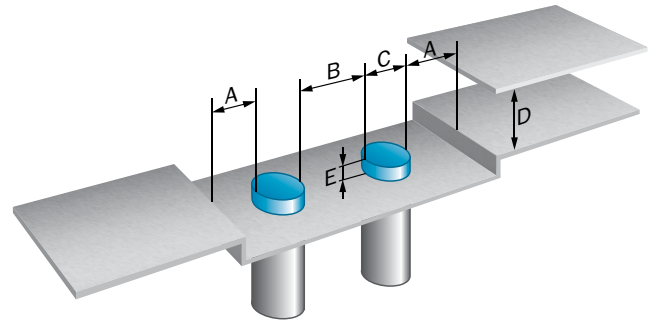

Opposite installation

C

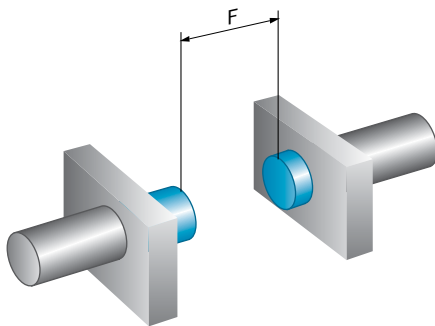

	Installation type	Sensing range Sn	A	B	C	D	E	F
IME18-05Bxxxxxx	Flush	5 mm	-	18 mm	18 mm	15 mm	-	40 mm
IME18-08Bxxxxxx	Flush	8 mm	-	36 mm	18 mm	24 mm	-	64 mm
IME18-08Nxxxxxx	Non-flush	8 mm	18 mm	36 mm	18 mm	24 mm	16 mm	64 mm
IME18-12Nxxxxxx	Non-flush	12 mm	18 mm	36 mm	18 mm	36 mm	24 mm	96 mm

Recommended accessories

Mounting brackets/plates





- Accessory type: Mounting brackets
- Material: Steel, zinc coated

Figure	Thread size	Configuration	Model name	Part no.
	M18	Straight	BEF-WG-M18	5321870
		Right angle	BEF-WN-M18	5308446

Cordsets and connectors

Connector M12, 4-pin

- **Connector type:** Female connector
- **Enclosure rating:** IP 67

Figure	Configuration	Jacket material	Cable length	Model name	Part no.
	Straight	PVC	2 m	DOL-1204-G02M	6009382
			5 m	DOL-1204-G05M	6009866
			10 m	DOL-1204-G10M	6010543
	Right angle	PVC	2 m	DOL-1204-W02M	6009383
			5 m	DOL-1204-W05M	6009867
			10 m	DOL-1204-W10M	6010541
	Straight	PBT	-	DOS-1204-G	6007302
	Right angle	PBT	-	DOS-1204-W	6007303

C

Terminal and alignment brackets

- **Accessory type:** Terminal brackets
- **Material:** Plastic (PA12), glass-fiber reinforced

Figure	Description	Model name	Part no.
	Terminal bracket M18, without fixed stop	BEF-KH-M18	2051481
	Terminal bracket M18, with fixed stop	BEF-KHF-M18	2051482

→ For additional accessories, please see page G-255

2-wire sensors in M30 housing for industrial use



C



Additional information

Detailed technical data C-85
 Ordering information C-86
 Dimensional drawings C-87
 Connection diagram C-88
 Installation note C-88
 Recommended accessories C-89

Product description

The SICK family of inductive AC and DC 2-wire sensors offers a high level of reliability, robustness and a long service life. Low power consumption, reduced wiring requirement and integrated, easy handling of the 2-wire sensors make this sensor family extremely popular. As

with conventional, mechanical position switches, setting up a series connection is easy to do. This ensures that modern, non-contact inductive 2-wire sensors can be used in existing applications.

At a glance

- Size M30
- AC and DC 2-wire
- Expanded sensing range of up to 15 mm
- Operating temperature from -25° C to +80° C
- IP 67 enclosure rating

Your benefits

- Reduced wiring requirement
- Quick and easy to install
- Low power consumption
- Reduced machine downtime
- Fewer maintenance costs due to longer service life
- High resistance to shock and vibrations

→ www.mysick.com/en/IM30

For more information, just enter the link or scan the QR code and get direct access to technical data, CAD design models, operating instructions, software, application examples and much more.



Detailed technical data

Features

	DC 2-wire	AC/DC 2-wire
Housing	M30 x 1.5	
Sensing range S_n	Flush	10 mm
	Non-flush	15 mm
Assured sensing range S_a	Standard, flush	8.1 mm
	Standard, non-flush	12.15 mm
Installation type	Flush / Non-flush	
Switching frequency	150 Hz	25 Hz ¹⁾ 30 Hz ²⁾
Output function	NO	NO / NC
Electrical wiring	DC 2-wire	AC/DC 2-wire
Enclosure rating ³⁾	IP 67	

¹⁾ AC.

²⁾ DC.

³⁾ According to EN60529.

C

Mechanical / electrical

	DC 2-wire	AC/DC 2-wire
Supply voltage	10 V DC ... 30 V DC	20 V AC/DC ... 250 V AC/DC
Ripple	≤ 10 %	–
Voltage drop	≤ 2.8 V ¹⁾	≤ 6.5 V AC, ≤ 6 V DC
Time delay before availability	≤ 50 ms	≤ 8 ms
Hysteresis	2 % ... 10 %	1 % ... 15 %
Repeatability ^{2) 3)}	≤ 2 %	≤ 10 %
Temperature drift (% of S_r)	± 10 %	
EMC	According to EN 60947-5-2	
Output current I_a	≤ 100 mA	≤ 350 mA, AC (+50 °C) ≤ 250 mA, AC (+80 °C) ≤ 100 mA, DC
Off-state current	≤ 0.8 mA	≤ 2.5 mA (AC 250 V) ≤ 1.3 mA (AC 110 V) ≤ 0.8 mA (DC 24 V)
Load resistance, min.	≥ 3 mA	≥ 5 mA
Short-time withstand current	–	2.2 A ⁴⁾
Connection type	Connector, M12 / Cable, 2 m, PVC	Cable, 2 m, PUR-PVC
Short-circuit protection	✓	–
Reverse polarity protection	✓	–
Power-up pulse protection	–	✓
Shock/vibration	30 g, 11 ms/10 ... 55 Hz, 1 mm	
Ambient operating temperature	–25 °C ... +70 °C	
Housing material	Metal, Nickel-plated brass	
Housing cap material	Plastic, PBT	Plastic, PC
Max. tightening torque	60 Nm	50 Nm
Protection class	–	II

	DC 2-wire	AC/DC 2-wire
Reduction factor R_m	The values are reference values which may vary	
Stainless steel (V2A)		
Flush	0.75	0.8
Non-flush	0.8	
Aluminum (solid)		
Flush	0.45	
Non-flush	0.5	0.45
Copper (Cu)		
Flush	0.35	0.4
Non-flush	0.45	0.4
Brass		
Flush	0.5	-
Non-flush	0.55	-

¹⁾ At I_a max.

²⁾ U_b and T_a constant.

³⁾ Of Sr.

⁴⁾ 20 ms / 0.5 Hz.



Ordering information

DC 2-wire

- **Housing:** M30 x 1.5

Sensing range S_n	Installation	Output function	Connection	Connection diagram	Model name	Part no.
10 mm	Flush	NO	Connector M12, 4-pin	Cd-014	IM30-10BDS-ZC1	6020328
			Cable, 2-wire, 2 m, PVC	Cd-012	IM30-10BDS-ZW1	6020326
15 mm	Non-flush	NO	Connector M12, 4-pin	Cd-014	IM30-15NDS-ZC1	6020332
			Cable, 2-wire, 2 m, PVC	Cd-012	IM30-15NDS-ZW1	6020330

AC/DC 2-wire

- **Housing:** M30 x 1.5

Sensing range S_n	Installation	Output function	Connection	Connection diagram	Model name	Part no.
10 mm	Flush	NO	Cable, 2-wire, 2 m, PUR-PVC	Cd-216	IM30-10BUS-ZU0	7902126
		NC	Cable, 2-wire, 2 m, PUR-PVC	Cd-216	IM30-10BU0-ZU0	7902127
15 mm	Non-flush	NO	Cable, 2-wire, 2 m, PUR-PVC	Cd-216	IM30-15NUS-ZU0	7902128
		NC	Cable, 2-wire, 2 m, PUR-PVC	Cd-216	IM30-15NU0-ZU0	7902129

Dimensional drawings

IM30-xxBxx-xC1, DC, flush, connector

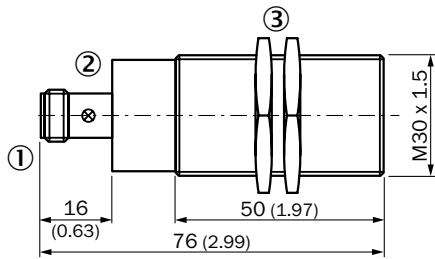

All dimensions in mm (inch)

- ① Connection
- ② LED indicator
- ③ Fastening nuts (2 x); 36 mm hex, metal

IM30-xxBxx-xW1, DC, flush, cable

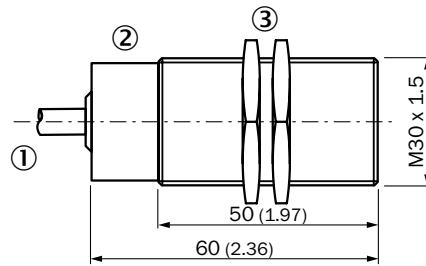

All dimensions in mm (inch)

- ① Connection
- ② LED indicator
- ③ Fastening nuts (2 x); 36 mm hex, metal

IM30-xxNxx-xC1, DC, non-flush, connector

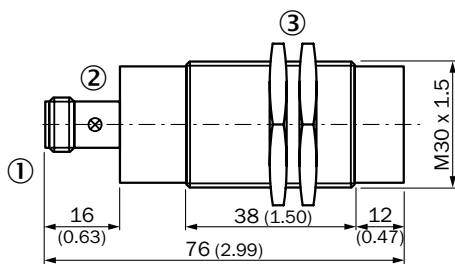

All dimensions in mm (inch)

- ① Connection
- ② LED indicator
- ③ Fastening nuts (2 x); 36 mm hex, metal

IM30-xxNxx-xW1, DC, non-flush, cable

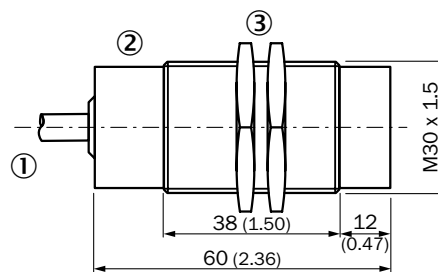

All dimensions in mm (inch)

- ① Connection
- ② LED indicator
- ③ Fastening nuts (2 x); 36 mm hex, metal

IM30-xxBxx-xU0, AC/DC, flush, cable

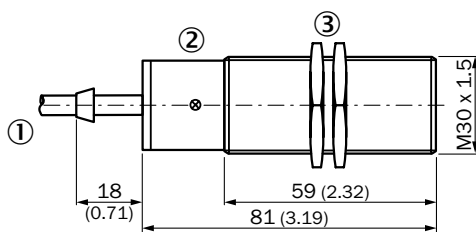

All dimensions in mm (inch)

- ① Connection
- ② LED indicator
- ③ Fastening nuts (2 x); 36 mm hex, metal

IM30-xxNxx-xU0, AC/DC, non-flush, cable

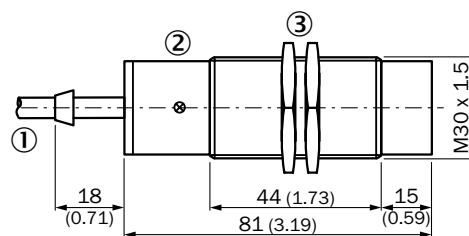

All dimensions in mm (inch)

- ① Connection
- ② LED indicator
- ③ Fastening nuts (2 x); 36 mm hex, metal

Connection diagram

Cd-012

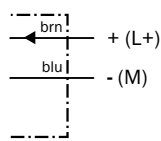

Cd-014

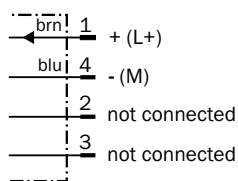

Cd-216

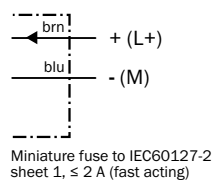

Installation note

Flush installation

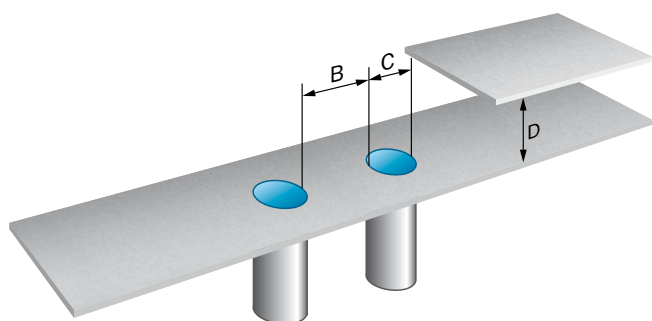

Non-flush installation

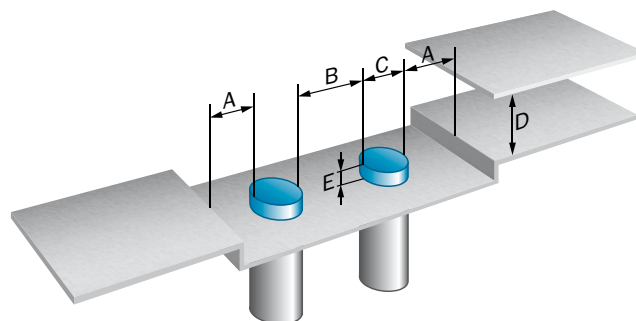

Opposite installation

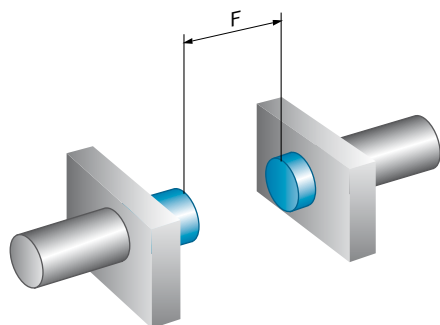



	Installation type	Electrical wiring	A	B	C	D	E	F
IM30-10BDx-xxx	Flush	DC 2-wire	10 mm	30 mm	30 mm	30 mm	0 mm	80 mm
IM30-10BUx-xxx	Flush	AC/DC 2-wire	0 mm	30 mm	30 mm	30 mm	0 mm	80 mm
IM30-15NDx-xxx	Non-flush	DC 2-wire	10 mm	45 mm	30 mm	45 mm	18 mm	120 mm
IM30-15NUx-xxx	Non-flush	AC/DC 2-wire	30 mm	60 mm	30 mm	45 mm	30 mm	120 mm

Recommended accessories



Mounting brackets

- **Accessory type:** Mounting brackets
- **Material:** Steel, zinc coated

Figure	Thread size	Configuration	Model name	Part no.
	M30	Straight	BEF-WG-M30	5321871
		Right angle	BEF-WN-M30	5308445

Cordsets and connectors

Connector M12, 4-pin

Figure	Connector type	Enclosure rating	Configuration	Jacket material	Cable length	Model name	Part no.	
	Female connector	IP 67	Straight	PVC	2 m	DOL-1204-G02M	6009382	
					5 m	DOL-1204-G05M	6009866	
		IP 68	Right angle	PVC	2 m	DOL-1204-L02M	6027945	
					5 m	DOL-1204-L05M	6027944	
		IP 67	Right angle	PVC	2 m	DOL-1204-W02M	6009383	
					5 m	DOL-1204-W05M	6009867	
		Male connector	IP 67	Straight	PBT	-	DOS-1204-G	6007302
				Right angle	PBT	-	DOS-1204-W	6007303
		Male connector	IP 67	Straight	PBT	-	STE-1204-G	6009932
				Right angle	PBT	-	STE-1204-W	6022084

C

→ For additional accessories, please see page G-255

3-/4-wire sensors in M30 housing for industrial use

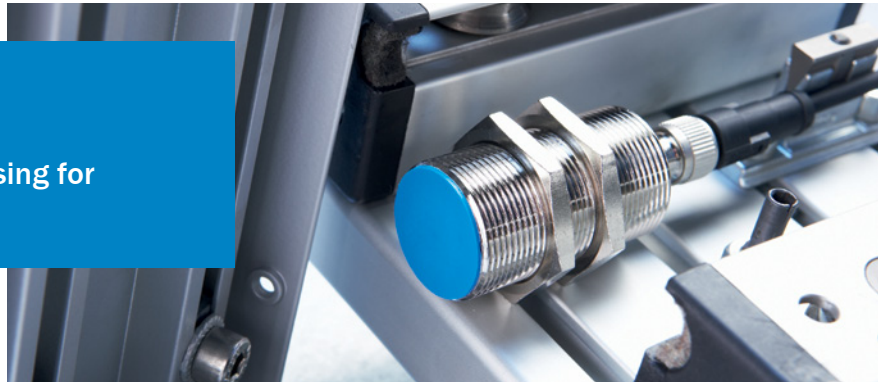

C



Product description

SICK's inductive sensors offer precise detection, less downtime and a long service life. The inductive M30 sensors pack high technology into the smallest of spaces. The integrated ASIC chip enables digital adjustment after the end of the manufacturing process. The ASIC ensures highly precise switching points and very high repeatability of values – for any

number of production runs. IME sensors are completely encapsulated with hot melt technology, which increases these sensors' life under shock and vibration. The customer benefits from high position accuracy in the machine and long-term reliability.

At a glance

- Size M30
- DC 3-/4-wire
- Expanded sensing range of up to 22 mm
- IP 67 enclosure rating
- Operating temperature from -25° C to +75° C

Your benefits

- Reduced machine downtime
- Reduced mechanical damage
- Fewer maintenance costs due to longer service life
- High resistance to shock and vibrations



Additional information

Detailed technical data C-91
 Ordering information C-92
 Dimensional drawings C-94
 Connection diagram C-95
 Installation note C-96
 Recommended accessories C-97

→ www.mysick.com/en/IME30
 For more information, just enter the link or scan the QR code and get direct access to technical data, CAD design models, operating instructions, software, application examples and much more.



Detailed technical data

Features

Housing	M30 x 1.5
Sensing range S_n	
Flush	10 mm / 15 mm
Standard, non-flush	15 mm / 20 mm
Assured sensing range S_a	
Short-body housing, flush	8.1 mm / 12.15 mm
Standard, non-flush	12.15 mm / 16.2 mm
Installation type	Flush / Non-flush
Switching frequency	500 Hz
Output type	NPN / PNP
Output function	NO / NC / Complementary
Electrical wiring	DC 3-wire / DC 4-wire
Enclosure rating ¹⁾	IP 67

¹⁾ According to EN60529.

Mechanical / electrical

Supply voltage	10 V DC ... 30 V DC
Ripple	≤ 10 %
Voltage drop	≤ 2 V
Power consumption ¹⁾	≤ 10 mA
Time delay before availability	≤ 125 ms
Hysteresis	3 % ... 15 % (depending on type)
Repeatability ^{2) 3)}	≤ 2 %
Temperature drift (% of S_r)	± 10 %
EMC	According to EN 60947-5-2
Output current I_a	≤ 200 mA
Connection type	Cable, 2 m, PVC / Connector, M12
Wire-break protection	✓
Short-circuit protection	✓
Reverse polarity protection	✓
Power-up pulse protection	✓
Shock/vibration	30 g, 11 ms/10 ... 55 Hz, 1 mm
Ambient operating temperature	-25 °C ... +75 °C
Housing material	Metal, Nickel-plated brass
Housing cap material	Plastic, PA6
Tightening torque, max.	100 Nm
Reduction factor R_m	The values are reference values which may vary
Carbon steel St37 (Fe)	1
Stainless steel (V2A, 304)	0.8
Aluminum (Al)	0.45
Copper (Cu)	0.4
Brass (Br)	0.4

¹⁾ Without load.

²⁾ U_b and T_a constant.

³⁾ Of S_r .

Ordering information

Sensing range S_n : 10 mm

- Housing: M30 x 1.5

Installation type	Output function	Output type	Connection	Housing	Connection diagram	Model name	Part no.
Flush	NO	PNP	Cable, 3-wire, 2 m, PVC	Short-body housing	Cd-001	IME30-10BPSZW2K	1040999
				Standard	Cd-001	IME30-10BPSZW2S	1041000
		Connector M12, 4-pin	Short-body housing	Cd-007	IME30-10BPSZCOK	1040997	
			Standard	Cd-007	IME30-10BPSZCOS	1040998	
		NPN	Cable, 3-wire, 2 m, PVC	Short-body housing	Cd-001	IME30-10BNSZW2K	1041007
				Standard	Cd-001	IME30-10BNSZW2S	1041008
	Connector M12, 4-pin	Short-body housing	Cd-007	IME30-10BNSZCOK	1041005		
		Standard	Cd-007	IME30-10BNSZCOS	1041006		
	NC	PNP	Cable, 3-wire, 2 m, PVC	Short-body housing	Cd-003	IME30-10BPOZW2K	1041003
				Standard	Cd-003	IME30-10BPOZW2S	1041004
			Connector M12, 4-pin	Short-body housing	Cd-008	IME30-10BPOZCOK	1041001
				Standard	Cd-008	IME30-10BPOZCOS	1041002
		NPN	Cable, 3-wire, 2 m, PVC	Short-body housing	Cd-003	IME30-10BNOZW2K	1041011
				Standard	Cd-003	IME30-10BNOZW2S	1041012
			Connector M12, 4-pin	Short-body housing	Cd-008	IME30-10BNOZCOK	1041010
				Standard	Cd-008	IME30-10BNOZCOS	1041009

Sensing range S_n : 15 mm

- Housing: M30 x 1.5

Installation type	Output function	Output type	Connection	Housing	Connection diagram	Model name	Part no.
Flush	NO	PNP	Cable, 3-wire, 2 m, PVC	Short-body housing	Cd-001	IME30-15BPSZW2K	1041031
				Standard	Cd-001	IME30-15BPSZW2S	1041032
		Connector M12, 4-pin	Short-body housing	Cd-007	IME30-15BPSZCOK	1041029	
			Standard	Cd-007	IME30-15BPSZCOS	1041030	
		NPN	Cable, 3-wire, 2 m, PVC	Short-body housing	Cd-001	IME30-15BNSZW2K	1041039
				Standard	Cd-001	IME30-15BNSZW2S	1041040
	Connector M12, 4-pin	Short-body housing	Cd-007	IME30-15BNSZCOK	1041037		
		Standard	Cd-007	IME30-15BNSZCOS	1041038		
	NC	PNP	Cable, 3-wire, 2 m, PVC	Short-body housing	Cd-003	IME30-15BPOZW2K	1041035
				Standard	Cd-003	IME30-15BPOZW2S	1041036
			Connector M12, 4-pin	Short-body housing	Cd-008	IME30-15BPOZCOK	1041033
				Standard	Cd-008	IME30-15BPOZCOS	1041034
		NPN	Cable, 3-wire, 2 m, PVC	Short-body housing	Cd-003	IME30-15BNOZW2K	1041043
				Standard	Cd-003	IME30-15BNOZW2S	1041044
			Connector M12, 4-pin	Short-body housing	Cd-008	IME30-15BNOZCOK	1041041
				Standard	Cd-008	IME30-15BNOZCOS	1041042
	Complementary	PNP	Cable, 4-wire, 2 m, PVC	Short-body housing	Cd-005	IME30-15BPPZW2K	1057551

Installation type	Output function	Output type	Connection	Housing	Connection diagram	Model name	Part no.
Non-flush	NO	PNP	Cable, 3-wire, 2 m, PVC	Short-body housing	Cd-001	IME30-15NPSZW2K	1041015
				Standard	Cd-001	IME30-15NPSZW2S	1041016
			Connector M12, 4-pin	Short-body housing	Cd-007	IME30-15NPSZC0K	1041013
				Standard	Cd-007	IME30-15NPSZC0S	1041014
		NPN	Cable, 3-wire, 2 m, PVC	Short-body housing	Cd-001	IME30-15NNSZW2K	1041023
				Standard	Cd-001	IME30-15NNSZW2S	1041024
			Connector M12, 4-pin	Short-body housing	Cd-007	IME30-15NNSZC0K	1041021
				Standard	Cd-007	IME30-15NNSZC0S	1041022
	NC	PNP	Cable, 3-wire, 2 m, PVC	Short-body housing	Cd-003	IME30-15NPOZW2K	1041019
				Standard	Cd-003	IME30-15NPOZW2S	1041020
			Connector M12, 4-pin	Short-body housing	Cd-008	IME30-15NPOZC0K	1041017
				Standard	Cd-008	IME30-15NPOZC0S	1041018
		NPN	Cable, 3-wire, 2 m, PVC	Short-body housing	Cd-003	IME30-15NNOZW2K	1041027
				Standard	Cd-003	IME30-15NNOZW2S	1041028
			Connector M12, 4-pin	Short-body housing	Cd-008	IME30-15NNOZC0K	1041025
				Standard	Cd-008	IME30-15NNOZC0S	1041026

Sensing range S_n : 20 mm

- Housing: M30 x 1.5

Installation type	Output function	Output type	Connection	Housing	Connection diagram	Model name	Part no.
Non-flush	NO	PNP	Cable, 3-wire, 2 m, PVC	Short-body housing	Cd-001	IME30-20NPSZW2K	1041047
				Standard	Cd-001	IME30-20NPSZW2S	1041048
			Connector M12, 4-pin	Short-body housing	Cd-007	IME30-20NPSZC0K	1041045
				Standard	Cd-007	IME30-20NPSZC0S	1041046
		NPN	Cable, 3-wire, 2 m, PVC	Short-body housing	Cd-001	IME30-20NNSZW2K	1041055
				Standard	Cd-001	IME30-20NNSZW2S	1041056
			Connector M12, 4-pin	Short-body housing	Cd-007	IME30-20NNSZC0K	1041053
				Standard	Cd-007	IME30-20NNSZC0S	1041054
	NC	PNP	Cable, 3-wire, 2 m, PVC	Short-body housing	Cd-003	IME30-20NPOZW2K	1041051
				Standard	Cd-003	IME30-20NPOZW2S	1041052
			Connector M12, 4-pin	Short-body housing	Cd-008	IME30-20NPOZC0K	1041049
				Standard	Cd-008	IME30-20NPOZC0S	1041050
		NPN	Cable, 3-wire, 2 m, PVC	Short-body housing	Cd-003	IME30-20NNOZW2K	1041059
				Standard	Cd-003	IME30-20NNOZW2S	1041060
			Connector M12, 4-pin	Short-body housing	Cd-008	IME30-20NNOZC0K	1041057
				Standard	Cd-008	IME30-20NNOZC0S	1041058

Dimensional drawings

IME30-xxBxxxW2K,
flush, cable, short-body housing

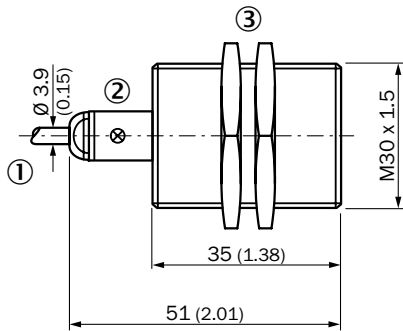

All dimensions in mm (inch)

- ① Connection
- ② LED indicator
- ③ Fastening nuts (2 x); 36 mm hex, metal

IME30-xxBxxW2S,
flush, cable, standard

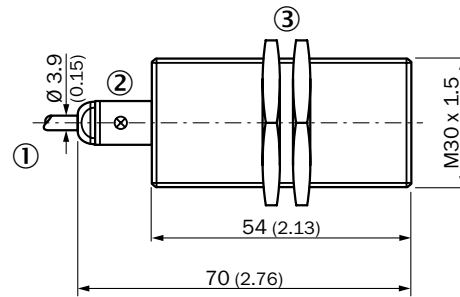

All dimensions in mm (inch)

- ① Connection
- ② LED indicator
- ③ Fastening nuts (2 x); 36 mm hex, metal

IME30-xxBxxxC0K,
flush, connector, short-body housing

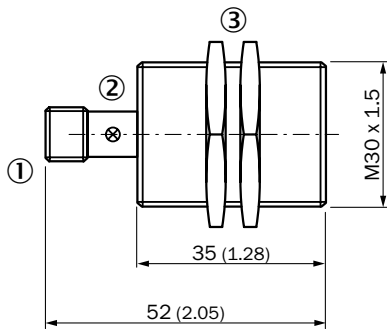

All dimensions in mm (inch)

- ① Connection
- ② LED indicator
- ③ Fastening nuts (2 x); 36 mm hex, metal

IME30-xxBxxxC0S,
flush, connector, standard

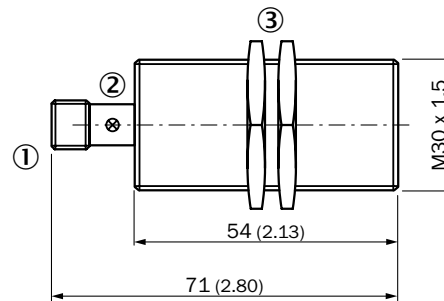

All dimensions in mm (inch)

- ① Connection
- ② LED indicator
- ③ Fastening nuts (2 x); 36 mm hex, metal

C

IME30-xxNxxxW2K,
non-flush, cable, short-body housing

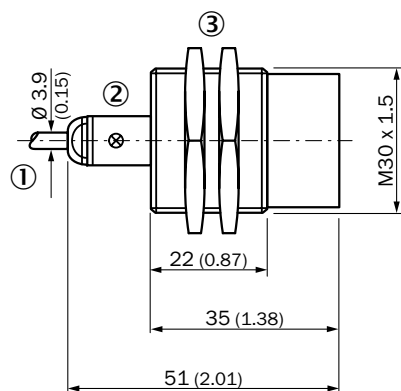

All dimensions in mm (inch)

- ① Connection
- ② LED indicator
- ③ Fastening nuts (2 x); 36 mm hex, metal

IME30-xxNxxxW2S,
non-flush, cable, standard

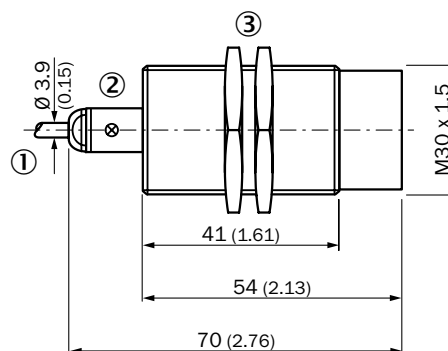

All dimensions in mm (inch)

- ① Connection
- ② LED indicator
- ③ Fastening nuts (2 x); 36 mm hex, metal

IME30-xxNxxxC0K,
non-flush, connector, short-body housing

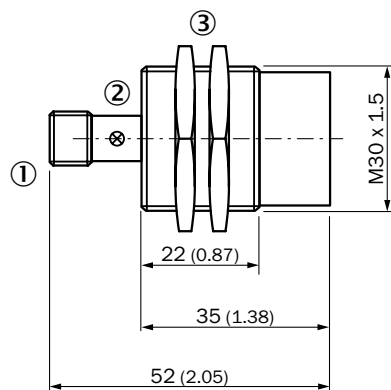

All dimensions in mm (inch)

- ① Connection
- ② LED indicator
- ③ Fastening nuts (2 x); 36 mm hex, metal

IME30-xxNxxxC0S,
non-flush, connector, standard

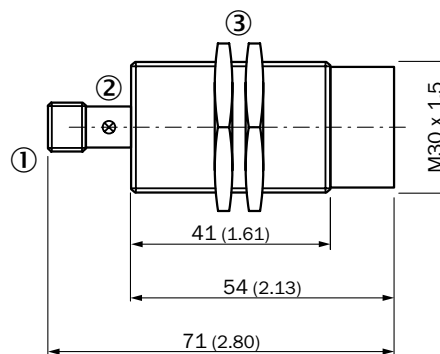

All dimensions in mm (inch)

- ① Connection
- ② LED indicator
- ③ Fastening nuts (2 x); 36 mm hex, metal

Connection diagram

Cd-001

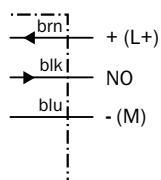

Cd-003

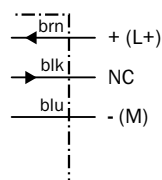

Cd-005

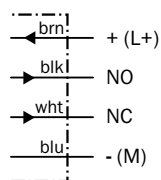

Cd-007

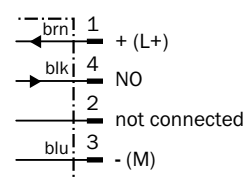

Cd-008

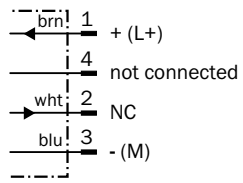

Installation note

Flush Installation

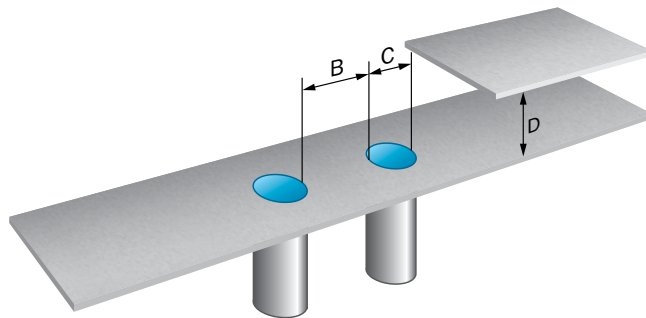

Non-flush installation

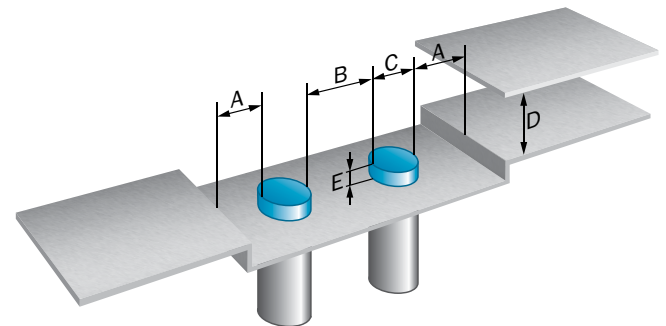

Opposite installation

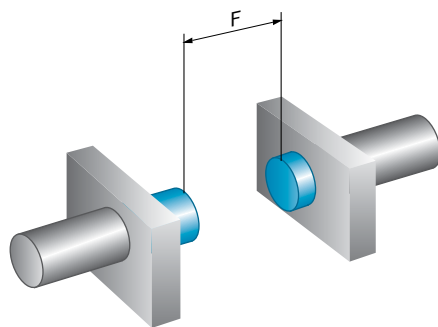



	Installation type	Sensing range Sn	A	B	C	D	E	F
IME30-10Bxxxxx	Flush	10 mm	-	30 mm	30 mm	30 mm	-	80 mm
IME30-15Bxxxxx	Flush	15 mm	-	60 mm	30 mm	45 mm	-	120 mm
IME30-15Nxxxxx	Non-flush	15 mm	30 mm	60 mm	30 mm	45 mm	30 mm	120 mm
IME30-20Nxxxxx	Non-flush	20 mm	30 mm	60 mm	30 mm	60 mm	40mm	160 mm

Recommended accessories

Mounting brackets





- **Accessory type:** Mounting brackets
- **Material:** Steel, zinc coated

Figure	Thread size	Configuration	Model name	Part no.
	M30	Right angle	BEF-WN-M30	5308445
		Straight	BEF-WG-M30	5321871

Cordsets and connectors

Connector M12, 4-pin

- **Connector type:** Female connector
- **Enclosure rating:** IP 67

Figure	Configuration	Jacket material	Cable length	Model name	Part no.
	Straight	PVC	2 m	DOL-1204-G02M	6009382
			5 m	DOL-1204-G05M	6009866
			10 m	DOL-1204-G10M	6010543
	Right angle	PVC	2 m	DOL-1204-W02M	6009383
			5 m	DOL-1204-W05M	6009867
			10 m	DOL-1204-W10M	6010541
	Straight	PBT	-	DOS-1204-G	6007302
	Right angle	PBT	-	DOS-1204-W	6007303

→ For additional accessories, please see page G-255

C

Inductive sensors with triple the sensing distance

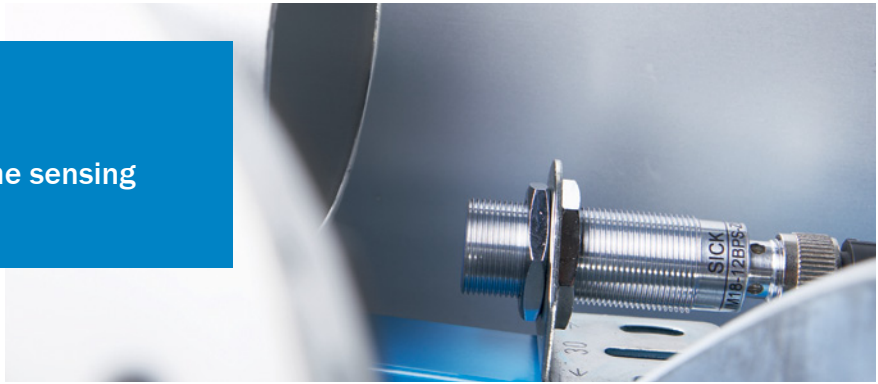

C



Additional information

Detailed technical data C-99
 Ordering information C-100
 Dimensional drawings C-101
 Connection diagram C-104
 Installation note C-105
 Recommended accessories C-106

Product description

IM Triple sensing distance inductive proximity sensors provide the longest sensing distances for many applications. Due to innovative ASIC technology, they offer greatly extended operating distances up to 40 mm.
 With a triple sensing distance, inductive sensors require less maintenance costs.

Not only can targets be detected from further away, but the risk of hitting and breaking either the sensor or the target is also greatly reduced. They can be used like conventional proximity sensors over an operating temperature range from -25° C to +70° C.

At a glance

- M8 to M30 housings
- Triple operating distance up to 40 mm
- Operating temperature from -25° C to +70 °C
- High switching frequencies

Your benefits

- Reduced machine downtime and maintenance costs
- Large operating reserve due to triple operating distance improves machine throughput – no missed targets
- Saves installation space on the machine. Less space required for the same operating distance when compared with standard sensors
- Lower risk of mechanical damage due their ability to be mounted further from the target
- High level of sensitivity makes them suitable for detecting difficult parts such as wires, thin sheets, small screws – reduces design and installation time

→ www.mysick.com/en/IM_Triplex
 For more information, just enter the link or scan the QR code and get direct access to technical data, CAD design models, operating instructions, software, application examples and much more.



Detailed technical data

Features

		IM08	IM12	IM18	IM30
Housing		M8 x 1	M12 x 1	M18 x 1	M30 x 1.5
Sensing range S_n	Quasi-flush	3 mm	6 mm	12 mm	22 mm
	Non-flush	6 mm	10 mm	20 mm	40 mm
Assured sensing range S_a	Quasi-flush	2.43 mm	4.86 mm	9.72 mm	17.82 mm
	Non-flush	4.86 mm	8.1 mm	16.2 mm	32.4 mm
Installation type		Quasi-flush ¹⁾ / Non-flush			
Switching frequency	Quasi-flush	1,000 Hz	800 Hz	500 Hz	200 Hz
	Non-flush	500 Hz	400 Hz	200 Hz	100 Hz
Output type		NPN / PNP			
Output function		NO	NO / NC	NO	NO / NC
Electrical wiring		DC 3-wire			
Enclosure rating ²⁾		IP 67			

¹⁾ Please note the installation notes.

²⁾ According to EN60529.

Mechanical / electrical

		IM08	IM12	IM18	IM30
Supply voltage		10 V DC ... 30 V DC			
Ripple ¹⁾		≤ 20 %			
Voltage drop ²⁾		≤ 2 V			
Current consumption ^{3) 3)}		≤ 10 mA			
Time delay before availability	Standard	≤ 50 ms	≤ 50 ms	≤ 50 ms / ≤ 100 ms	≤ 200 ms
	Short-body housing	≤ 50 ms	≤ 50 ms	≤ 50 ms	≤ 200 ms
Hysteresis		1 % ... 15 %			
Repeatability ^{4) 5)}		≤ 5 %			
Temperature drift (% of S_r)		± 10 %			
EMC		According to EN 60947-5-2			
Output current I_a		≤ 200 mA			
Connection type		Cable, 2 m, PVC / Connector, M8	Connector, M12 / Cable, 2 m, PVC	Cable, 2 m, PVC / Connector, M12	Connector, M12 / Cable, 2 m, PVC
Short-circuit protection		✓			
Reverse polarity protection		✓			
Power-up pulse protection		✓			
Shock/vibration		30 g, 11 ms/10 ... 55 Hz, 1 mm			
Ambient operating temperature		-25 °C ... +70 °C			
Housing material		Metal, Chrome-plated brass			
Housing cap material		Plastic, PBTP			
Tightening torque, max.		4 Nm	10 Nm	25 Nm	70 Nm
Adjustment indicators ⁶⁾		✓		-	

C

	IM08	IM12	IM18	IM30
Reduction factor R_m	The values are reference values which may vary			
Stainless steel (V2A, 304)				
Quasi-flush	-		0.63	0.66
Non-flush	0.77		0.66	0.78
Stainless steel (V4A, 316L)				
Quasi-flush	0.72	0.7	-	
Non-flush	-	-	-	
Aluminum (Al)				
Quasi-flush	0.33	0.3	0.26	0.4
Non-flush	0.47	0.49	0.4	0.42
Copper (Cu)				
Quasi-flush	0.27	0.25	0.2	0.35
Non-flush	0.44	0.45	0.35	0.37
Brass (Br)				
Quasi-flush	0.41	0.4	0.33	0.45
Non-flush	0.55	0.56	0.45	0.47

¹⁾ Of V_s .

²⁾ At I_a max.

³⁾ Without load.

⁴⁾ Of Sr.

⁵⁾ UB = 20 ... 30 VDC, TA = 23 °C ± 5 °C.

⁶⁾ LED lights continuously ($0 \leq s \leq 0.8$ sr) ; LED flashing ($0.8 \text{ sr} < s \leq \text{sr}$)

Ordering information

IM08

- Housing: M8 x 1

Sensing range S_n	Installation	Output function	Output type	Connection	Connection diagram	Model name	Part no.
3 mm	Quasi-flush	NO	PNP	Cable, 3-wire, 2 m, PVC	Cd-001	IM08-03BPS-ZW1	6027505
				Connector M8, 3-pin	Cd-002	IM08-03BPS-ZT1	6025574
6 mm	Non-flush	NO	NPN	Cable, 3-wire, 2 m, PVC	Cd-001	IM08-03BNS-ZW1	6028074
				Connector M8, 3-pin	Cd-002	IM08-06NPS-ZT1	6027508
6 mm	Non-flush	NO	PNP	Cable, 3-wire, 2 m, PVC	Cd-001	IM08-06NPS-ZW1	6027506
				Connector M8, 3-pin	Cd-002	IM08-06NNS-ZW1	6027507

IM12

- Housing: M12 x 1

Sensing range S_n	Installation	Output function	Output type	Connection	Connection diagram	Model name	Part no.
6 mm	Quasi-flush	NO	PNP	Cable, 3-wire, 2 m, PVC	Cd-001	IM12-06BPS-ZW1	6027509
				Connector M12, 4-pin	Cd-007	IM12-06BPS-ZC1	6027511
		NC	NPN	Connector M12, 4-pin	Cd-007	IM12-06BNS-ZC1	6030524
10 mm	Non-flush	NO	PNP	Cable, 3-wire, 2 m, PVC	Cd-003	IM12-06BPO-ZW1	6027510
				Connector M12, 4-pin	Cd-007	IM12-10NPS-ZC1	6027514
		NPN	Cable, 3-wire, 2 m, PVC	Cd-001	IM12-10NPS-ZW1	6027512	
				Cable, 3-wire, 2 m, PVC	Cd-001	IM12-10NNS-ZW1	6027513

IM18

- Housing: M18 x 1

Sensing range S_n	Installation	Output function	Output type	Connection	Housing	Connection diagram	Model name	Part no.
12 mm	Quasi-flush	NO	PNP	Connector M12, 4-pin	Standard	Cd-007	IM18-12BPS-ZC1	6027517
				Cable, 3-wire, 2 m, PVC	Standard	Cd-001	IM18-12BPS-ZW1	6027515
			NPN	Connector M12, 4-pin	Short-body housing	Cd-007	IM18-12BPS-ZCK	6025569
				Cable, 3-wire, 2 m, PVC	Standard	Cd-001	IM18-12BNS-ZW1	6027516
20 mm	Non-flush	NO	PNP	Connector M12, 4-pin	Standard	Cd-007	IM18-20NPS-ZC1	6027519
				Cable, 3-wire, 2 m, PVC	Standard	Cd-001	IM18-20NPS-ZW1	6027518
			NPN	Connector M12, 4-pin	Standard	Cd-007	IM18-20NNS-ZC1	6041997
				Cable, 3-wire, 2 m, PVC	Standard	Cd-001	IM18-20NNS-ZW1	6028093

IM30

- Housing: M30 x 1.5

Sensing range S_n	Installation	Output function	Output type	Connection	Housing	Connection diagram	Model name	Part no.
22 mm	Quasi-flush	NO	NPN	Connector M12, 4-pin	Standard	Cd-007	IM30-22BNS-ZC1	6033033
				Cable, 3-wire, 2 m, PVC	Standard	Cd-001	IM30-22BNS-ZW1	6027520
			PNP	Connector M12, 4-pin	Standard	Cd-007	IM30-22BPS-ZC1	6027521
				Connector M12, 4-pin	Short-body housing	Cd-007	IM30-22BPS-ZCK	6025566
40 mm	Non-flush	NO	PNP	Connector M12, 4-pin	Short-body housing	Cd-008	IM30-22BPO-ZCK	6025568
			NPN	Connector M12, 4-pin	Standard	Cd-007	IM30-40NNS-ZC1	6033087

Dimensional drawings

IM08-xxBxx-xW1, M8, quasi-flush, cable

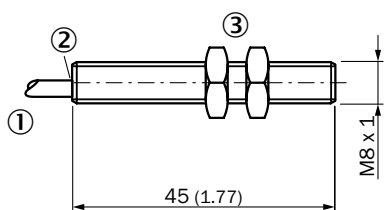

All dimensions in mm (inch)

- ① Connection
- ② LED indicator
- ③ Fastening nuts (2 x); width across 13, metal

IM08-xxBxx-xT1, M8, quasi-flush, connector

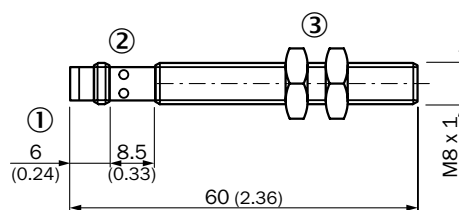

All dimensions in mm (inch)

- ① Connection
- ② LED indicator
- ③ Fastening nuts (2 x); width across 13, metal

IM08-xxNxx-xW1,
M8, quasi-flush, cable

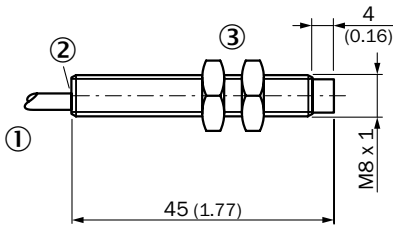

All dimensions in mm (inch)

- ① Connection
- ② LED indicator
- ③ Fastening nuts (2 x); width across 13, metal

IM08-xxNxx-xT1,
M8, non-flush, connector

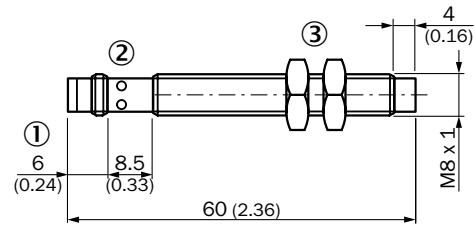

All dimensions in mm (inch)

- ① Connection
- ② LED indicator
- ③ Fastening nuts (2 x); width across 13, metal

C

IM12-xxBxx-xW1,
M12, quasi-flush, cable

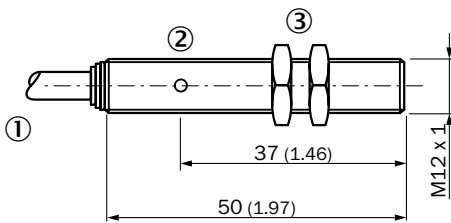

All dimensions in mm (inch)

- ① Connection
- ② LED indicator
- ③ Fastening nuts (2 x); width across 17, metal

IM12-xxBxx-xC1,
M12, quasi-flush, connector

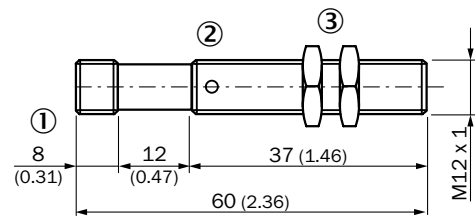

All dimensions in mm (inch)

- ① Connection
- ② LED indicator
- ③ Fastening nuts (2 x); width across 17, metal

IM12-xxNxx-xW1,
M12, non-flush, cable

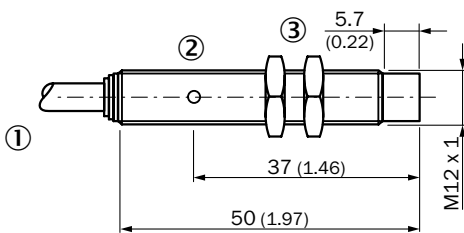

All dimensions in mm (inch)

- ① Connection
- ② LED indicator
- ③ Fastening nuts (2 x); width across 17, metal

IM12-xxNxx-xC1,
M12, non-flush, connector

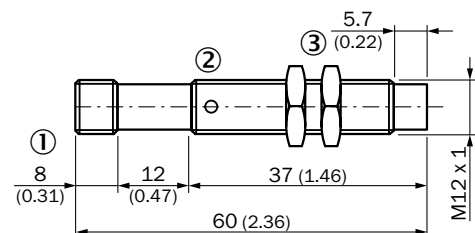

All dimensions in mm (inch)

- ① Connection
- ② LED indicator
- ③ Fastening nuts (2 x); width across 17, metal

IM18-xxBxx-xW1,
M18, quasi-flush, cable, standard

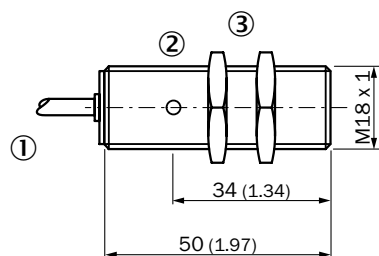

All dimensions in mm (inch)

- ① Connection
- ② LED indicator
- ③ Fastening nuts (2 x); 36 mm hex, plastic

IM18-xxBxx-xC1,
M18, quasi-flush, connector, standard

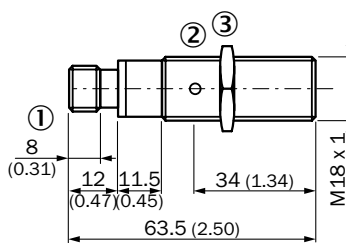

All dimensions in mm (inch)

- ① Connection
- ② LED indicator
- ③ Fastening nuts (2 x); 36 mm hex, plastic

IM18-xxBxx-xCK,
M18, quasi-flush, connector, short-body housing

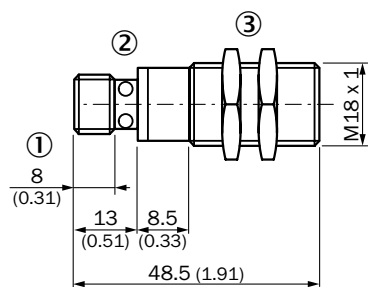

All dimensions in mm (inch)

- ① Connection
- ② LED indicator
- ③ Fastening nuts (2 x); 24 mm hex, metal

IM18-xxNxx-xC1,
M18, non-flush, connector, standard

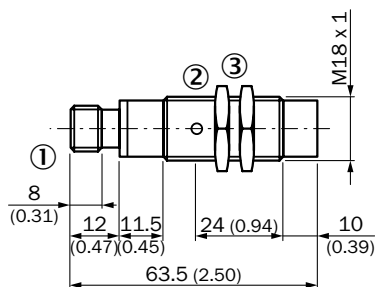

All dimensions in mm (inch)

- ① Connection
- ② LED indicator
- ③ Fastening nuts (2 x); 36 mm hex, metal

IM18-xxNxx-xW1,
M18, non-flush, cable, standard

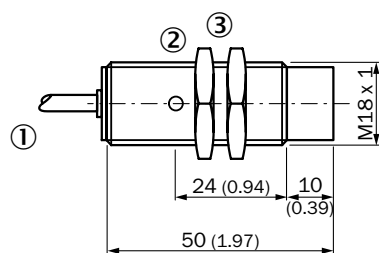

All dimensions in mm (inch)

- ① Connection
- ② LED indicator
- ③ Fastening nuts (2 x); 36 mm hex, metal

IM30-xxBxx-xC1,
M30, quasi-flush, connector, standard

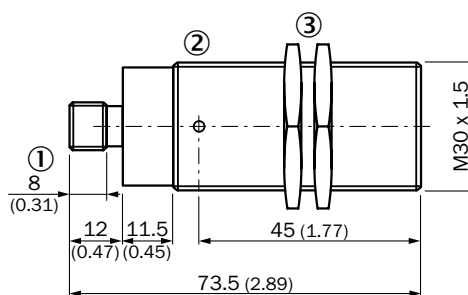

All dimensions in mm (inch)

- ① Connection
- ② LED indicator
- ③ Fastening nuts (2 x); 36 mm hex, metal

C

IM30-xxBxx-xW1,
M30, quasi-flush, cable, standard

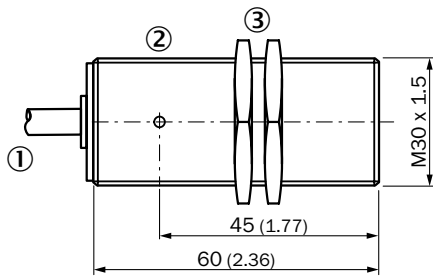

All dimensions in mm (inch)

- ① Connection
- ② LED indicator
- ③ Fastening nuts (2 x); 36 mm hex, metal

IM30-xxBxx-xCK,
M30, quasi-flush, connector, short-body housing

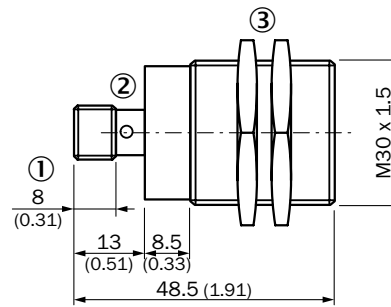

All dimensions in mm (inch)

- ① Connection
- ② LED indicator
- ③ Fastening nuts (2 x); 36 mm hex, metal

C

IM30-xxNxx-xC1,
M30, non-flush, connector, standard

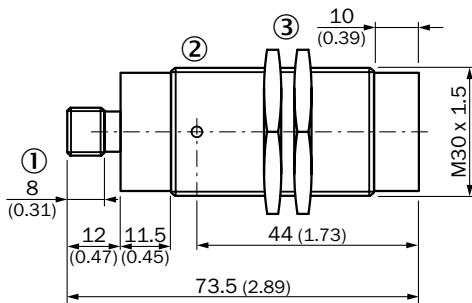

All dimensions in mm (inch)

- ① Connection
- ② LED indicator
- ③ Fastening nuts (2 x); 36 mm hex, metal

Connection diagram

Cd-001

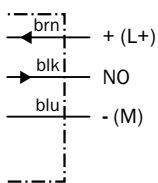

Cd-002

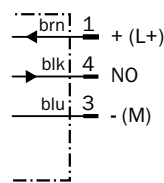

Cd-003

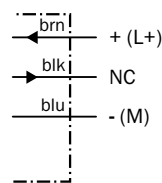

Cd-007

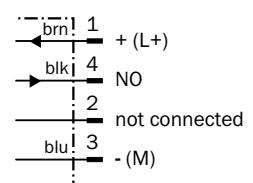

Cd-008

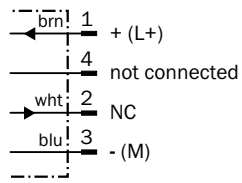

Installation note

Flush installation

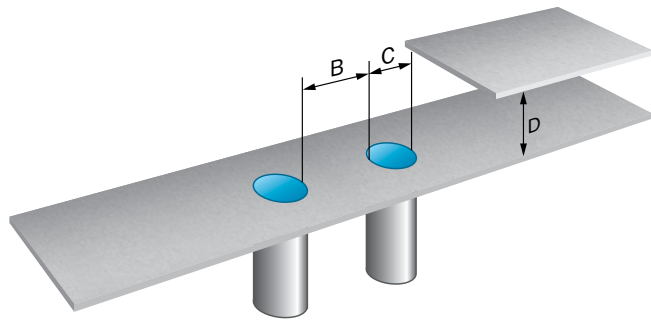

Non-flush installation

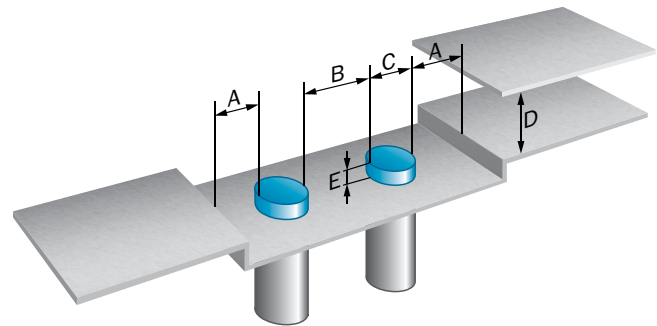

C

Opposite installation

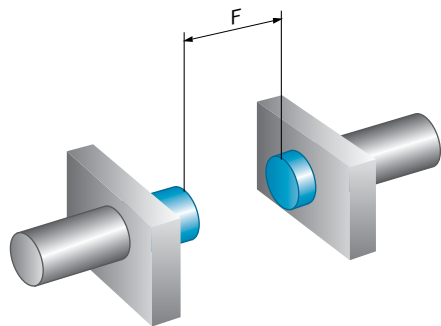









	Housing	Installation type	A	B	C	D	E	F
IM08-03Bxx-xxx	M8	Flush	2 mm	8 mm	8 mm	9 mm	1 mm	30 mm
IM08-06Nxx-xxx	M8	Non-flush	8 mm	20 mm	8 mm	18 mm	8 mm	60 mm
IM12-06Bxx-xxx	M12	Flush	6 mm	18 mm	12 mm	18 mm	2 mm	60 mm
IM12-10Nxx-xxx	M12	Non-flush	10 mm	30 mm	12 mm	30 mm	10 mm	100 mm
IM18-12Bxx-xxx	M18	Flush	9 mm	26 mm	18 mm	36 mm	4 mm	120 mm
IM18-20Nxx-xxx	M18	Non-flush	21 mm	60 mm	18 mm	60 mm	20 mm	200 mm
IM30-22Bxx-xxx	M30	Flush	22 mm	50 mm	30 mm	66 mm	6 mm	220 mm
IM30-40Nxx-xxx	M30	Non-flush	40 mm	120 mm	30 mm	120 mm	Aluminum: 25 mm Steel: 35 mm Brass: 25 mm Stainless steel: 20 mm	400 mm

Recommended accessories

Mounting brackets

- **Accessory type:** Mounting brackets
- **Material:** Steel, zinc coated







C

Figure	Thread size	Configuration	Model name	Part no.	IM08	IM12	IM18	IM30
	M8	Straight	BEF-WG-M08	5321722	●	-	-	-
		Right angle	BEF-WN-M08	5321721	●	-	-	-
	M12	Straight	BEF-WG-M12	5321869	-	●	-	-
		Right angle	BEF-WN-M12	5308447	-	●	-	-
	M18	Straight	BEF-WG-M18	5321870	-	-	●	-
		Right angle	BEF-WN-M18	5308446	-	-	●	-
	M30	Straight	BEF-WG-M30	5321871	-	-	-	●
		Right angle	BEF-WN-M30	5308445	-	-	-	●

Cordsets and connectors

Connector M12, 4-pin





- Enclosure rating: IP 67

Figure	Connector type	Configuration	Jacket material	Cable length	Model name	Part no.	
	Female connector	Straight	PVC	2 m	DOL-1204-G02M	6009382	
				5 m	DOL-1204-G05M	6009866	
		Right angle	PVC	2 m	DOL-1204-W02M	6009383	
				5 m	DOL-1204-W05M	6009867	
		Straight	PBT	-	DOS-1204-G	6007302	
				Right angle	PBT	-	DOS-1204-W
		Male connector	Straight			PBT	-
				Right angle	PBT		-

C



Connector M8, 3-pin

- Connector type: Female connector
- Enclosure rating: IP 67

Figure	Configuration	Jacket material	Cable length	Model name	Part no.		
	Straight	PVC	2 m	DOL-0803-G02M	6010785		
			5 m	DOL-0803-G05M	6022009		
			Right angle	PVC	2 m	DOL-0803-W02M	6008489
					5 m	DOL-0803-W05M	6022010
	Straight	PBT	-	DOS-0803-G	7902077		
			Right angle	PBT	-	DOS-0803-W	7902078

Terminal and alignment brackets

- **Material:** Plastic (PA12), glass-fiber reinforced

Figure	Description	Thread size	Model name	Part no.	IM08	IM12	IM18
	Terminal brackets, without fixed stop	M8	BEF-KH-M08	2051477	●	-	-
		M12	BEF-KH-M12	2051479	-	●	-
		M18	BEF-KH-M18	2051481	-	-	●
	Terminal brackets, with fixed stop	M8	BEF-KHF-M08	2051478	●	-	-
		M12	BEF-KHF-M12	2051480	-	●	-
		M18	BEF-KHF-M18	2051482	-	-	●

→ For additional accessories, please see page G-255

C

C

Inductive sensors for wash down environments



C



Product description

IMF sensors are specifically designed to work in the wash down conditions of the food and beverage industry. IMF housings are not only made of an extremely rugged mix of stainless steel

(316L/1.4404) and the Food and Drug Administration (FDA)-certified plastic PPS, but they also withstand the most stringent cleaning processes.

At a glance

- Extremely watertight (IP 68/IP 69K) for wash down environments
- Stainless steel housing (316L/1.4404)
- Front cap made of PPS (FDA-certified material)
- Extended temperature range (-40 to +80 °C). Tolerates short-term temperature increases up to 100 °C
- Resistant to industrial cleaning agents, ECOLAB and JohnsonDiversey certified
- Laser etched part number

Your benefits

- Reduced machine downtime
- Hygienic process due to FDA approved material and hygienic design
- Reduced maintenance costs due to sensor's resistance to aggressive cleaning cycles
- No restrictions on cleaning agents or processes, ensuring reliable operation



Additional information

Detailed technical data.....C-111
 Ordering information.....C-112
 Dimensional drawings.....C-114
 Connection diagram.....C-114
 Installation note.....C-115
 Recommended accessories.....C-116

→ www.mysick.com/en/IMF
 For more information, just enter the link or scan the QR code and get direct access to technical data, CAD design models, operating instructions, software, application examples and much more.



Detailed technical data

Features

	IMF12	IMF18
Housing	M12 x 1	M18 x 1
Sensing range S_n	Flush	5 mm / 8 mm
	Non-flush	8 mm / 12 mm
Assured sensing range S_a	Flush	4.05 mm / 6.48 mm
	Non-flush	6.48 mm / 9.72 mm
Installation type	Flush / non-flush	
Switching frequency	2,000 Hz	1,500 Hz
Output type	PNP / NPN	
Output function	NO / NC / Complementary	
Electrical wiring	DC 3-wire / DC 4-wire	
Enclosure rating	IP 68 ¹⁾ , IP 69K ²⁾	

¹⁾ According to EN60529.

²⁾ According to EN40050.

Mechanical / electrical

	IMF12	IMF18
Supply voltage	10 V ... 30 V	
Ripple	≤ 10 %	
Voltage drop	≤ 2 V	
Current consumption ¹⁾	≤ 15 mA	
Time delay before availability	Approx. 50 ms	
Hysteresis	1 % ... 20 %	
Repeatability ^{2) 3)}	5 %	
Temperature drift (% of S_p)	± 10 %	
EMC	According to EN 60947-5-2	
Output current I_a	≤ 200 mA	
Connection type	Connector, M12	
Short-circuit protection	✓	
Reverse polarity protection	✓	
Power-up pulse protection	✓	
Shock/vibration	30 g, 11 ms/10 ... 55 Hz, 1 mm	
Ambient operating temperature ⁴⁾	-40 °C ... +80 °C	
Housing material	Stainless steel, 316L/1.4404	
Housing cap material	Plastic, PPS	
Tightening torque, max.	20 Nm	50 Nm

	IMF12	IMF18
Reduction factor R_m	The values are reference values which may vary	
Stainless steel (V2A, 304)		
Flush	0.75	0.65
Non-flush	0.75	0.65
Aluminum (Al)		
Flush	0.3	0.3
Non-flush	0.4	0.38
Copper (Cu)		
Flush	0.3	0.2
Non-flush	0.33	0.3
Brass (Br)		
Flush	0.4	0.4
Non-flush	0.45	0.42

¹⁾ Without load.

²⁾ U_b and T_a constant.

³⁾ Of Sr.

⁴⁾ +100 °C for 15 minutes.

Ordering information

IMF12

- **Housing:** M12 x 1
- **Connection:** Connector M12, 4-pin

Sensing range S_n	Installation	Output function	Electrical wiring	Output type	Connection diagram	Model name	Part no.
2 mm	Flush	NO	DC 3-wire	PNP	Cd-007	IMF12-02BPSVCOS	6035452
				NPN	Cd-007	IMF12-02BNSVCOS	6035453
		NC	DC 3-wire	PNP	Cd-008	IMF12-02BPOVCOS	6035454
				NPN	Cd-008	IMF12-02BNOVCOS	6035455
		Complementary	DC 4-wire	PNP	Cd-006	IMF12-02BPPVCOS	6035215
				NPN	Cd-006	IMF12-02BNPVCOS	6035216
4 mm	Flush	NO	DC 3-wire	PNP	Cd-007	IMF12-04BPSVCOS	6035460
				NPN	Cd-007	IMF12-04BNSVCOS	6035461
		NC	DC 3-wire	PNP	Cd-008	IMF12-04BPOVCOS	6035462
				NPN	Cd-008	IMF12-04BNOVCOS	6035463
		Complementary	DC 4-wire	PNP	Cd-006	IMF12-04BPPVCOS	6035219
				NPN	Cd-006	IMF12-04BNPVCOS	6035220
	Non-flush	NO	DC 3-wire	PNP	Cd-007	IMF12-04NPSVCOS	6035456
				NPN	Cd-007	IMF12-04NNSVCOS	6035457
		NC	DC 3-wire	PNP	Cd-008	IMF12-04NPOVCOS	6035458
				NPN	Cd-008	IMF12-04NNOVCOS	6035459
		Complementary	DC 4-wire	PNP	Cd-006	IMF12-04NPPVCOS	6035217
				NPN	Cd-006	IMF12-04NNPVCOS	6035218

Sensing range S_n	Installation	Output function	Electrical wiring	Output type	Connection diagram	Model name	Part no.
8 mm	Non-flush	NO	DC 3-wire	PNP	Cd-007	IMF12-08NPSVC0S	6035464
				NPN	Cd-007	IMF12-08NNSVC0S	6035465
		NC	DC 3-wire	PNP	Cd-008	IMF12-08NPOVC0S	6035466
				NPN	Cd-008	IMF12-08NNOVC0S	6035467
		Complementary	DC 4-wire	PNP	Cd-006	IMF12-08NPPVC0S	6035221
				NPN	Cd-006	IMF12-08NNPVC0S	6035222

IMF18

- **Housing:** M18 x 1
- **Connection:** Connector M12, 4-pin

Sensing range S_n	Installation	Output function	Electrical wiring	Output type	Connection diagram	Model name	Part no.
5 mm	Flush	NO	DC 3-wire	PNP	Cd-007	IMF18-05BPSVC0S	6035468
				NPN	Cd-007	IMF18-05BNSVC0S	6035469
		NC	DC 3-wire	PNP	Cd-008	IMF18-05BPOVC0S	6035470
				NPN	Cd-008	IMF18-05BNOVC0S	6035471
		Complementary	DC 4-wire	PNP	Cd-006	IMF18-05BPPVC0S	6035223
				NPN	Cd-006	IMF18-05BNPVC0S	6035224
8 mm	Flush	NO	DC 3-wire	PNP	Cd-007	IMF18-08BPSVC0S	6035476
				NPN	Cd-007	IMF18-08BNSVC0S	6035477
		NC	DC 3-wire	PNP	Cd-008	IMF18-08BPOVC0S	6035478
				NPN	Cd-008	IMF18-08BNOVC0S	6035479
		Complementary	DC 4-wire	PNP	Cd-006	IMF18-08BPPVC0S	6035227
				NPN	Cd-006	IMF18-08BNPVC0S	6035228
	Non-flush	NO	DC 3-wire	PNP	Cd-007	IMF18-08NPSVC0S	6035472
				NPN	Cd-007	IMF18-08NNSVC0S	6035473
		NC	DC 3-wire	PNP	Cd-008	IMF18-08NPOVC0S	6035474
				NPN	Cd-008	IMF18-08NNOVC0S	6035475
		Complementary	DC 4-wire	PNP	Cd-006	IMF18-08NPPVC0S	6035225
				NPN	Cd-006	IMF18-08NNPVC0S	6035226
12 mm	Non-flush	NO	DC 3-wire	PNP	Cd-007	IMF18-12NPSVC0S	6035480
				NPN	Cd-007	IMF18-12NNSVC0S	6035481
		NC	DC 3-wire	PNP	Cd-008	IMF18-12NPOVC0S	6035482
				NPN	Cd-008	IMF18-12NNOVC0S	6035483
		Complementary	DC 4-wire	NPN	Cd-006	IMF18-12NNPVC0S	6035230
				PNP	Cd-006	IMF18-12NPPVC0S	6035229

C

Dimensional drawings

IMF12-xxBxxxxxx,
M12, flush

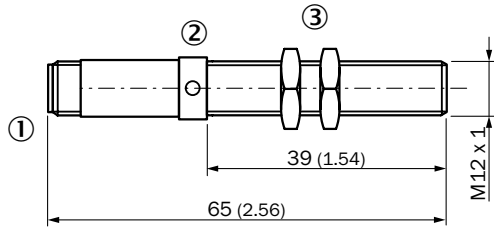

All dimensions in mm (inch)

- ① Connection
- ② LED indicator
- ③ Fastening nuts (2 x); width across 17, stainless steel

IMF12-xxNxxxxxx,
M12, non-flush

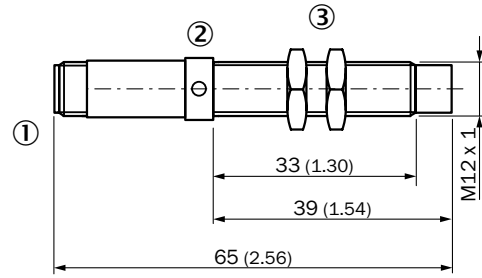

All dimensions in mm (inch)

- ① Connection
- ② LED indicator
- ③ Fastening nuts (2 x); width across 17, stainless steel

C

IMF18-xxBxxxxxx,
M18, flush

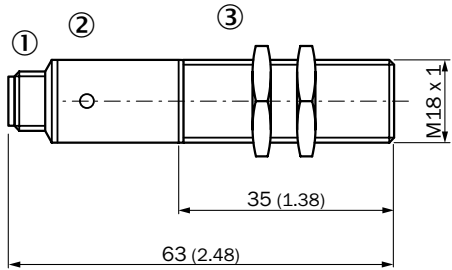

All dimensions in mm (inch)

- ① Connection
- ② LED indicator
- ③ Fastening nuts (2 x); width across 17, stainless steel

IMF18-xxNxxxxxx,
M18, non-flush

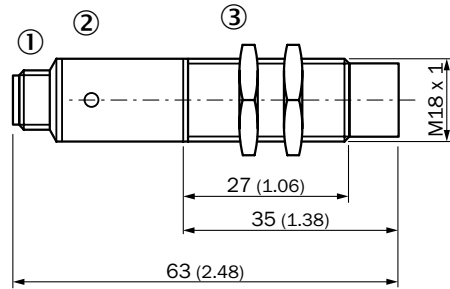

All dimensions in mm (inch)

- ① Connection
- ② LED indicator
- ③ Fastening nuts (2 x); width across 17, stainless steel

Connection diagram

Cd-006

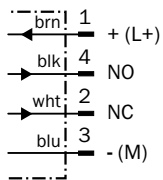

Cd-007

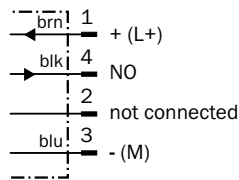

Cd-008

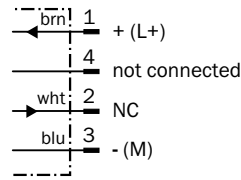

Installation note

Flush installation

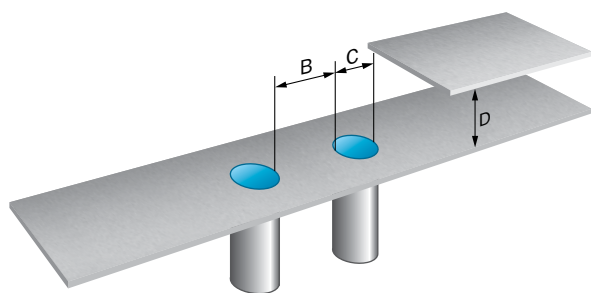

Non-flush installation

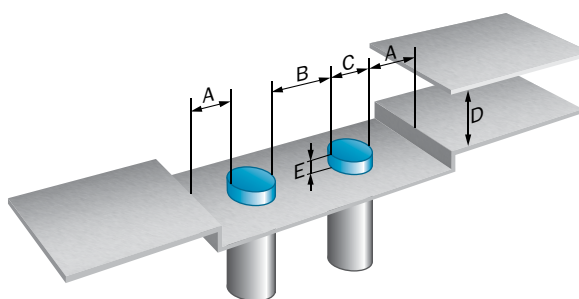

Opposite installation

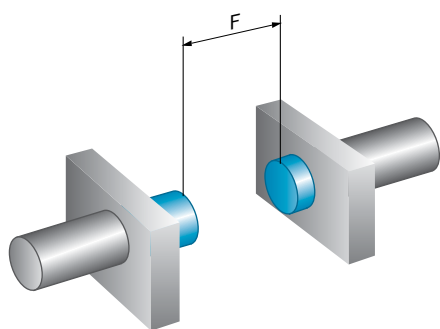

C

	Housing	Installation type	Sensing range Sn	A	B	C	D	E	F
IMF12-02Bxxxxxx	M12	Flush	2 mm	6 mm	12 mm	12 mm	6 mm	Aluminum: 2 mm Steel: 0 mm Brass: 2 mm Stainless steel: 0 mm	16 mm
IMF12-04Bxxxxxx	M12	Flush	4 mm	6 mm	12 mm	12 mm	12 mm	Aluminum: 2.4 mm Steel: 0 mm Brass: 2.4 mm Stainless steel: 0 mm	32 mm
IMF12-04Nxxxxxx	M12	Non-flush	4 mm	12 mm	24 mm	12 mm	12 mm	6 mm	32 mm
IMF12-08Nxxxxxx	M12	Non-flush	8 mm	12 mm	24 mm	12 mm	24 mm	12 mm	64 mm
IMF18-05Bxxxxxx	M18	Flush	5 mm	9 mm	18 mm	18 mm	15 mm	3.6 mm	40 mm
IMF18-08Bxxxxxx	M18	Flush	8 mm	9 mm	18 mm	18 mm	24 mm	Aluminum: 5.4 mm Steel: 1.8 mm Brass: 5.4 mm Stainless steel: 1.8 mm	64 mm
IMF18-08Nxxxxxx	M18	Non-flush	8 mm	18 mm	36 mm	18 mm	24 mm	12 mm	64 mm
IMF18-12Nxxxxxx	M18	Non-flush	12 mm	18 mm	36 mm	18 mm	36 mm	16 mm	96 mm

Recommended accessories

Mounting brackets

- **Accessory type:** Mounting brackets
- **Material:** Stainless steel

Figure	Thread size	Configuration	Model name	Part no.	IMF12	IMF18
	M12	Straight	BEF-WG-M12N	5320950	●	-
		Right angle	BEF-WN-M12N	5320949	●	-
	M18	Straight	BEF-WG-M18N	5320948	-	●
		Right angle	BEF-WN-M18N	5320947	-	●

Cordsets and connectors

Connector M12, 4-pin

- **Connector type:** Female connector
- **Enclosure rating:** IP 69K
- **Jacket material:** PVC



Figure	Configuration	Cable length	Model name	Part no.
	Straight	2 m	DOL-1204-G02MN	6028128
		5 m	DOL-1204-G05MN	6028130
	Right angle	2 m	DOL-1204-W02MN	6028129
		5 m	DOL-1204-W05MN	6028131

- **Connector type:** Female connector

Figure	Configuration	Cable length	Model name	Part no.
	Right angle	2 m	DSL-1204-B02MN	6028198
		5 m	DSL-1204-B05MN	6028199
	Straight	2 m	DSL-1204-G02MN	6028195
		5 m	DSL-1204-G05MN	6028196

Terminal and alignment brackets

- **Accessory type:** Universal bar clamp systems

Figure	Material	Model name	Part no.	IMF12	IMF18
	Stainless steel 1.4301	BEF-KHS-KH3N	5322627	●	●
	Stainless steel 1.4571 (sheet), Stainless steel 1.4408 (clamp)	BEF-KHS-N05N	2051621	●	-
		BEF-KHS-N06N	2051622	-	●

→ For additional accessories, please see page G-255

C

Single-piece stainless steel sensors for the highest demands



Product description

The IP 69K-rated IM Inox inductive proximity sensors withstand high-pressure cleaners with aggressive cleaning agents, acids, and alkalis often used in food and beverage applications. These sensors are fully encapsulated in a stainless steel (316L/1.4404) housing that is

resistant to leaks and cleaning agents. The IM Inox sensors can withstand extreme stress, offer triple the operating distance and the highest performance. Users can choose from different housing shapes, sizes and electrical configurations.

At a glance

- Stainless steel housing (316L/1.4404)
- Extremely watertight (IP 68/IP 69K)
- Triple sensing distance
- High resistance to mechanical stress
- Watertight housing suitable for use in hygienic and wash down areas
- Resistant to aggressive cleaning agents
- Visual adjustment indicator via output LED

Your benefits

- Less machine downtime due to rugged sensor design
- Cost reduction due to long service life even under the most extreme ambient conditions
- Quick and easy installation due to adjustment indicator via LEDs
- Large operating reserve due to triple operating distance
- High resistance to shock and impact due to stainless steel sensing face
- No restrictions on cleaning agents or processes, ensuring reliable operation



Additional information

Detailed technical dataC-119

Ordering informationC-120

Dimensional drawingsC-121

Connection diagramC-122

Installation noteC-122

Recommended accessoriesC-123

→ www.mysick.com/en/IM_INOX

For more information, just enter the link or scan the QR code and get direct access to technical data, CAD design models, operating instructions, software, application examples and much more.



Detailed technical data

Features

	IM 12	IM 18	IM 30
Housing	M12 x 1	M18 x 1	M30 x 1.5
Sensing range S_n	Flush	6 mm	10 mm
	Non-flush	10 mm	20 mm
Assured sensing range S_a	Flush	4.86 mm	8.1 mm
	Non-flush	8.1 mm	16.2 mm
Installation type	Flush / Non-flush		
Switching frequency	Flush	600 Hz	300 Hz
	Non-flush	400 Hz	200 Hz
Output type	NPN / PNP		
Output function	NO / NC		NO
Electrical wiring	DC 3-wire		
Enclosure rating ¹⁾	IP 68, IP 69K		

¹⁾ According to EN60529.

Mechanical / electrical

	IM 12	IM 18	IM 30
Supply voltage	10 V DC ... 30 V DC		
Ripple ¹⁾	≤ 20 %		
Voltage drop ²⁾	≤ 2 V		
Current consumption ³⁾	≤ 10 mA		
Time delay before availability	≤ 40 ms		
Hysteresis	1 % ... 15 %		
Repeatability ^{4) 5)}	≤ 5 %		
Temperature drift (% of S_p)	≤ 10 %		
EMC	According to EN 60947-5-2		
Output current I_a	≤ 200 mA		
Connection type	Connector, M12, 4-pin		
Short-circuit protection	✓		
Reverse polarity protection	✓		
Power-up pulse protection	✓		
Shock/vibration	30 g, 11 ms/10 ... 55 Hz, 1 mm		
Ambient operating temperature	-25 °C ... +85 °C		
Housing material	Stainless steel		
Housing cap material	Stainless steel		
Tightening torque, max.	≤ 20 Nm	≤ 50 Nm	≤ 150 Nm
Adjustment indicators ⁶⁾	✓		

	IM 12	IM 18	IM 30
Reduction factor R_m	The values are reference values which may vary		
Stainless steel (V4A, 316L)			
Flush	0.45 / 0.9 ⁷⁾	0.4 / 0.8 ⁷⁾	0.5 / 0.9 ⁷⁾
Non-flush	0.5 / 0.9 ⁷⁾	0.4 / 0.8 ⁷⁾	- / 0.5 ⁷⁾
Aluminum (Al)	1	1	1
Copper (Cu)			
Flush	0.85	0.85	0.9
Non-flush	0.8	0.85	0.9
Brass (Br)	1.3	1.3	1.2

¹⁾ Of V_S .

²⁾ At I_a max.

³⁾ Without load.

⁴⁾ Of Sr.

⁵⁾ UB = 20 ... 30 VDC, TA = 23 °C ± 5 °C.

⁶⁾ LED lights continuously (0 ≤ s ≤ 0.8 Sr); LED flashing (0.8 Sr < s ≤ Sr).

⁷⁾ Target size 1 mm / 2mm.

C

Ordering information

IM 12

- **Housing:** M12 x 1
- **Connection:** Connector M12, 4-pin

Sensing range S_n	Installation	Output function	Output type	Connection diagram	Model name	Part no.
6 mm	Flush	NO	NPN	Cd-007	IM12-06BNS-NC1	6027573
			PNP	Cd-007	IM12-06BPS-NC1	6027572
		NC	PNP	Cd-008	IM12-06BPO-NC1	6027574
10 mm	Non-flush	NO	NPN	Cd-007	IM12-10NNS-NC1	6027576
			PNP	Cd-007	IM12-10NPS-NC1	6027575

IM 18

- **Housing:** M18 x 1
- **Connection:** Connector M12, 4-pin

Sensing range S_n	Installation	Output function	Output type	Connection diagram	Model name	Part no.
10 mm	Flush	NO	NPN	Cd-007	IM18-10BNS-NC1	6027578
			PNP	Cd-007	IM18-10BPS-NC1	6027577
		NC	PNP	Cd-008	IM18-10BPO-NC1	6027579
20 mm	Non-flush	NO	NPN	Cd-007	IM18-20NNS-NC1	6027581
			PNP	Cd-007	IM18-20NPS-NC1	6027580

IM 30

- **Housing:** M30 x 1.5
- **Connection:** Connector M12, 4-pin

Sensing range S_n	Installation	Output function	Output type	Connection diagram	Model name	Part no.
20 mm	Flush	NO	NPN	Cd-007	IM30-20BNS-NC1	6027583
			PNP	Cd-007	IM30-20BPS-NC1	6027582
40 mm	Non-flush	NO	NPN	Cd-007	IM30-40NNS-NC1	6027585
			PNP	Cd-007	IM30-40NPS-NC1	6027584

Dimensional drawings

IM12-xxBxx-xxx, M12, flush

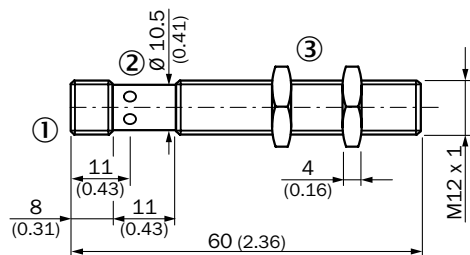

All dimensions in mm (inch)

- ① Connection
- ② LED indicator
- ③ Fastening nuts (2 x); width across 17, stainless steel V4A

IM12-xxNxx-xxx, M12, non flush

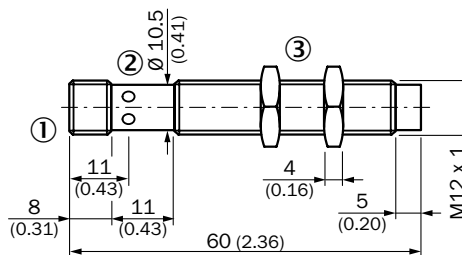

All dimensions in mm (inch)

- ① Connection
- ② LED indicator
- ③ Fastening nuts (2 x); width across 17, stainless steel V4A

IM18-xxBxx-xxx, M18, flush

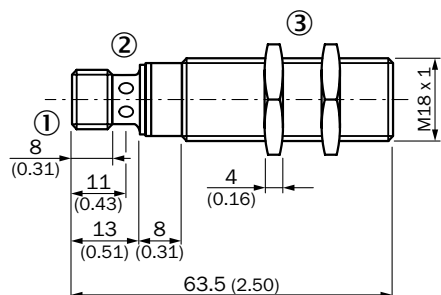

All dimensions in mm (inch)

- ① Connection
- ② LED indicator
- ③ Fastening nuts (2 x); 24 mm hex, metal

IM18-xxNxx-xxx, M18, non flush

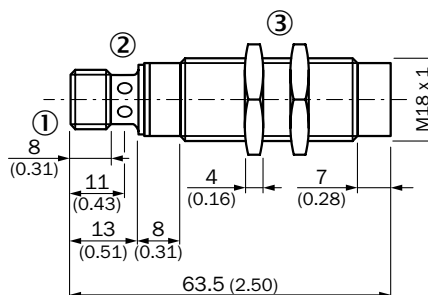

All dimensions in mm (inch)

- ① Connection
- ② LED indicator
- ③ Fastening nuts (2 x); 24 mm hex, metal

IM30-xxBxx-xxx, M30, flush

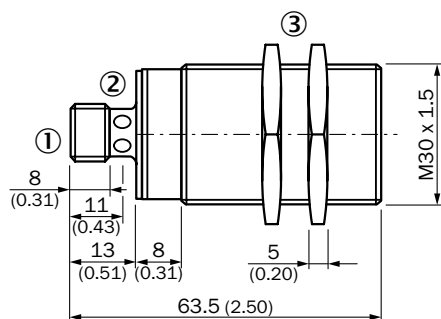

All dimensions in mm (inch)

- ① Connection
- ② LED indicator
- ③ Fastening nuts (2 x); 24 mm hex, metal

IM30-xxNxx-xxx, M30, non flush

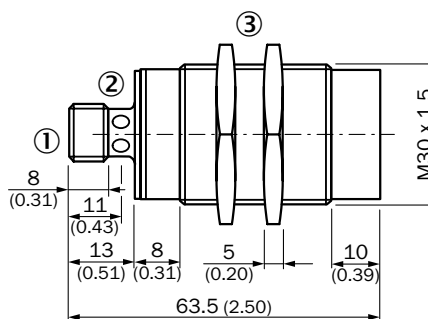

All dimensions in mm (inch)

- ① Connection
- ② LED indicator
- ③ Fastening nuts (2 x); 24 mm hex, metal

Connection diagram

Cd-007

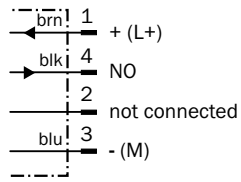

Cd-008

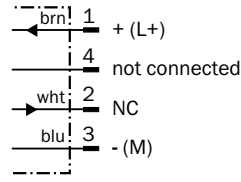

Installation note

Flush / Non-flush installation

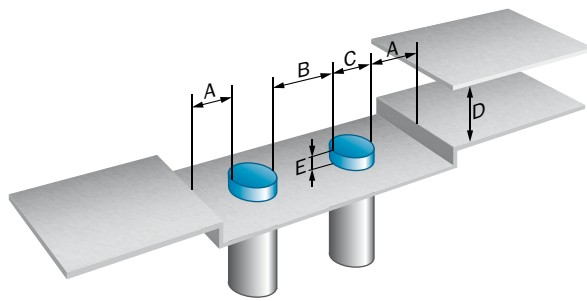

Opposite installation

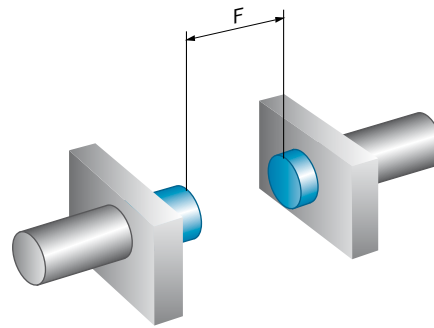

	Housing	Installation type	A	B	C	D	E	F
IM12-xxBxx-xxx	M12	Flush	6 mm	38 mm	12 mm	18 mm	0 mm	60 mm
IM12-xxNxx-xxx	M12	Non-flush	24 mm	108 mm	12 mm	30 mm	Aluminum: 13 mm Steel: 22 mm Brass: 15 mm Stainless steel: 21 mm	100 mm
IM18-xxBxx-xxx	M18	Flush	16 mm	42 mm	18 mm	30 mm	0 mm	100 mm
IM18-xxNxx-xxx	M18	Non-flush	41 mm	182 mm	18 mm	60 mm	Aluminum: 20 mm Steel: 34 mm Brass: 22 mm Stainless steel: 36 mm	200 mm
IM30-xxBxx-xxx	M30	Flush	30 mm	80 mm	30 mm	60 mm	0 mm	200 mm
IM30-xxNxx-xxx	M30	Non-flush	75 mm	270 mm	30 mm	120 mm	Aluminum: 34 mm Steel: 18 mm Brass: 34 mm Stainless steel: 18 mm	400 mm

Recommended accessories

Mounting brackets

- **Accessory type:** Mounting brackets
- **Material:** Stainless steel

Figure	Thread size	Configuration	Model name	Part no.	IM12	IM18
	M12	Straight	BEF-WG-M12N	5320950	●	-
		Right angle	BEF-WN-M12N	5320949	●	-
	M18	Straight	BEF-WG-M18N	5320948	-	●
		Right angle	BEF-WN-M18N	5320947	-	●

C

Cordsets and connectors



Connector M12, 4-pin

- **Connector type:** Female connector
- **Enclosure rating:** IP 69K
- **Jacket material:** PVC

Figure	Configuration	Cable length	Model name	Part no.
	Straight	2 m	DOL-1204-G02MN	6028128
		5 m	DOL-1204-G05MN	6028130
		10 m	DOL-1204-G10MN	6028132
		25 m	DOL-1204-G25MN	6028134
	Right angle	2 m	DOL-1204-W02MN	6028129
		5 m	DOL-1204-W05MN	6028131
		10 m	DOL-1204-W10MN	6028133
		25 m	DOL-1204-W25MN	6028135

Terminal and alignment brackets

- **Accessory type:** Universal bar clamp systems
- **Material:** Stainless steel 1.4571 (sheet), Stainless steel 1.4408 (clamp)

Figure	Thread size	Model name	Part no.	IM12	IM18
	M12	BEF-KHS-N05N	2051621	●	-
	M18	BEF-KHS-N06N	2051622	-	●

→ For additional accessories, please see page G-255

Namur sensors for explosive zones



C



Additional information

Detailed technical dataC-125
 Ordering informationC-126
 Dimensional drawingsC-126
 Connection diagramC-128
 Installation noteC-128
 Recommended accessoriesC-129

Product description

IM Namur inductive proximity sensors provide safe detection in explosive ATEX zones. These high-quality sensors can be reliably used in 2G or 1G areas.

At a glance

- Namur sensor for safe applications
- ATEX device category 1G and 2G
- Output according to DIN EN 60947-5-6
- Types M8 to M30

Your benefits

- Exceptional protection in explosive areas
- Category 1G and 2G for zones 0 and 1 provides protection in explosive areas
- Output according to DIN EN 60947-5-6

Detailed technical data

Features

	IM08 Namur	IM12 Namur	IM18 Namur	IM30 Namur
Housing	M8 x 1	M12 x 1	M18 x 1	M30 x 1.5
Sensing range S_n	Flush	1 mm	2 mm	5 mm
	Non-flush	-	4 mm	8 mm
Assured sensing range S_a	Flush	0.81 mm	1.62 mm	4.05 mm
	Non-flush	-	3.24 mm	6.48 mm
Switching frequency	Flush	2,000 Hz	1,200 Hz	720 Hz
	Non-flush	-	1,500 Hz	300 Hz
Output function	NC			
Output type	Namur			
Enclosure rating ¹⁾	IP 67			

¹⁾ According to EN60529.

Mechanical / electrical

	IM08 Namur	IM12 Namur	IM18 Namur	IM30 Namur
Hazardous area category	1G, 2G			
Supply voltage ¹⁾	7.5 V DC ... 25 V DC			
Current consumption ¹⁾	≤ 30 mA			
Hysteresis	1 % ... 15 %			
Temperature drift (% of S_p)	± 10 %			
EMC	According to EN 60947-5-6			
Current consumption, sensor is activated	≤ 1 mA			
Current consumption, sensor is not activated	≥ 2.2 mA			
Connection type	Cable, 2-wire, 2 m, PVC	Cable, 2-wire, 2 m, PVC	Cable, 2-wire, 2 m, PVC	
Shock/vibration	30 g, 11 ms/10 ... 55 Hz, 1 mm			
Ambient operating temperature	-20 °C ... +70 °C			
Housing material	Metal, Nickel-plated brass			
Housing cap material	Plastic, PBT			
Tightening torque, max.	2.5 Nm	7 Nm	35 Nm	50 Nm
EC Approval Certificate	PTB 03 ATEX 2037			
Nominal voltage	8.2 V DC			
Reduction factor R_m	The values are reference values which may vary			
Stainless steel (V2A, 304)	0.7			
Aluminum (Al)	0.4			
Copper (Cu)	0.3			
Brass (Br)	0.5			

¹⁾ When used outside the hazardous area.

²⁾ For connection only to a separately certified, intrinsically safe electrical circuit.

Ordering information

IM08 Namur

- **Housing:** M08 x 1
- **Connection:** Cable, 2-wire, 2 m, PVC

Sensing range S_n	Installation	Output function	Connection diagram	Model name	Part no.
1 mm	Flush	NC	Cd-012	IM08-01B-N-ZW0	6021123

IM12 Namur

- **Housing:** M12 x 1
- **Connection:** Cable, 2-wire, 2 m, PVC

Sensing range S_n	Installation	Output function	Connection diagram	Model name	Part no.
4 mm	Non-flush	NC	Cd-012	IM12-04N-N-ZW0	6021125
2 mm	Flush	NC	Cd-012	IM12-02B-N-ZW0	6021124

C

IM18 Namur

- **Housing:** M18 x 1
- **Connection:** Cable, 2-wire, 2 m, PVC

Sensing range S_n	Installation	Output function	Connection diagram	Model name	Part no.
8 mm	Non-flush	NC	Cd-012	IM18-08N-N-ZW0	6021127
5 mm	Flush	NC	Cd-012	IM18-05B-N-ZW0	6021126

IM30 Namur

- **Housing:** M30 x 1.5
- **Connection:** Cable, 2-wire, 2 m, PVC

Sensing range S_n	Installation	Output function	Connection diagram	Model name	Part no.
15 mm	Non-flush	NC	Cd-012	IM30-15N-N-ZW0	6021129
10 mm	Flush	NC	Cd-012	IM30-10B-N-ZW0	6021128

Dimensional drawings

IM08-xxB-x-xxx,
M8, flush

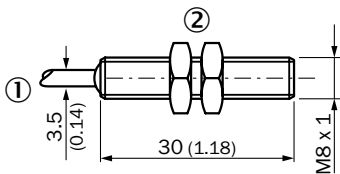

All dimensions in mm (inch)

- ① Connection
- ② Fastening nuts (2 x); width across 13, metal

IM12-xxN-x-xxx,
M12, non-flush

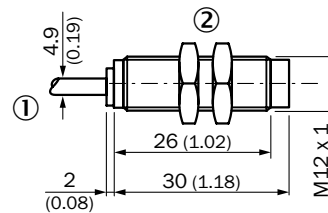

All dimensions in mm (inch)

- ① Connection
- ② Fastening nuts (2 x); width across 17, metal

**IM12-xxB-x-xxx,
M12, flush**

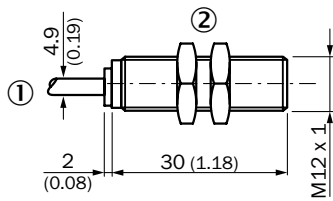

All dimensions in mm (inch)

- ① Connection
- ② Fastening nuts (2 x); width across 17, metal

**IM18-xxN-x-xxx,
M18, non-flush**

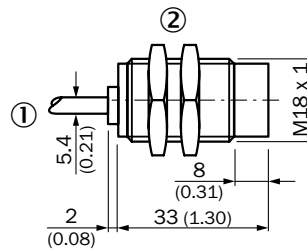

All dimensions in mm (inch)

- ① Connection
- ② Fastening nuts (2 x); 24 mm hex, metal

**IM18-xxB-x-xxx,
M18, flush**

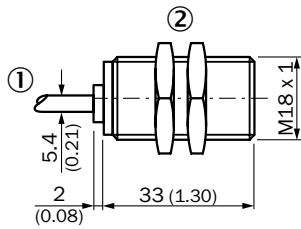

All dimensions in mm (inch)

- ① Connection
- ② Fastening nuts (2 x); 24 mm hex, metal

**IM30-xxN-x-xxx,
M30, non-flush**

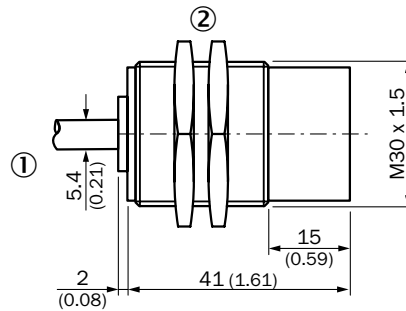

All dimensions in mm (inch)

- ① Connection
- ② Fastening nuts (2 x); 36 mm hex, metal

**IM30-xxB-x-xxx,
M39, flush**

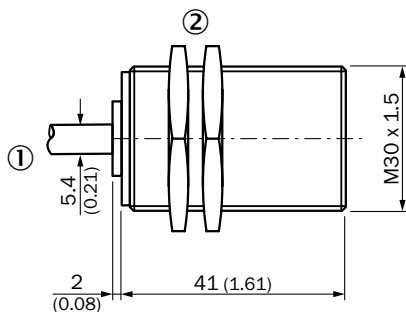

All dimensions in mm (inch)

- ① Connection
- ② Fastening nuts (2 x); 36 mm hex, metal

C

Connection diagram

Cd-012

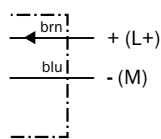

Installation note

Flush installation

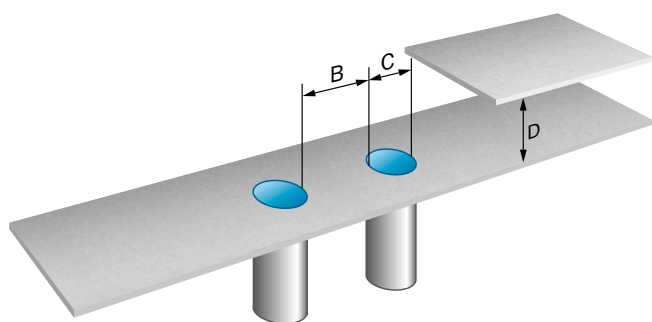

Non-flush installation

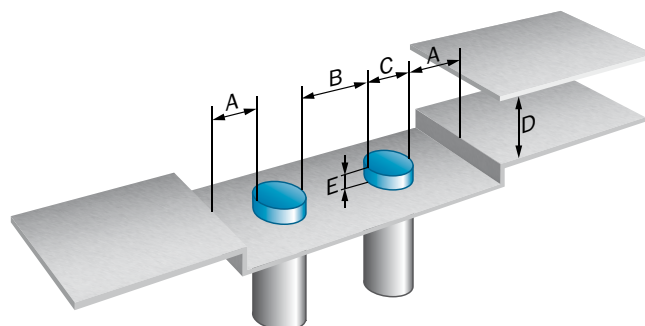

Opposite installation

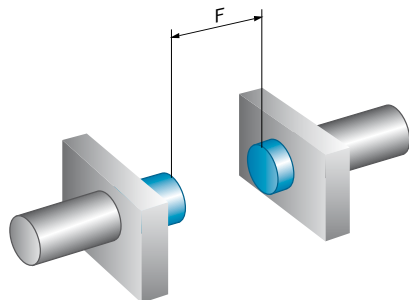









	Housing	Installation type	A	B	C	D	E	F
IM08-xxB-x-xxx	M8	Flush	-	8 mm	8 mm	3 mm	-	8 mm
IM12-xxB-x-xxx	M12	Flush	-	12 mm	12 mm	6 mm	-	16 mm
IM12-xxN-x-xxx	M12	Non-flush	12 mm	24 mm	12 mm	12 mm	8 mm	32 mm
IM18-xxB-x-xxx	M18	Flush	-	18 mm	18 mm	15 mm	-	40 mm
IM18-xxN-x-xxx	M18	Non-flush	18 mm	36 mm	18 mm	24 mm	16 mm	64 mm
IM30-xxB-x-xxx	M30	Flush	-	30 mm	30 mm	30 mm	-	80 mm
IM30-xxN-x-xxx	M30	Non-flush	30 mm	60 mm	30 mm	45 mm	30 mm	120 mm

Recommended accessories

Mounting brackets



- **Accessory type:** Mounting brackets
- **Material:** Steel, zinc coated

Figure	Thread size	Configuration	Model name	Part no.	IM08 Namur	IM12 Namur	IM18 Namur	IM30 Namur
	M8	Straight	BEF-WG-M08	5321722	●	-	-	-
		Right angle	BEF-WN-M08	5321721	●	-	-	-
	M12	Straight	BEF-WG-M12	5321869	-	●	-	-
		Right angle	BEF-WN-M12	5308447	-	●	-	-
	M18	Straight	BEF-WG-M18	5321870	-	-	●	-
		Right angle	BEF-WN-M18	5308446	-	-	●	-
	M30	Straight	BEF-WG-M30	5321871	-	-	-	●
		Right angle	BEF-WN-M30	5308445	-	-	-	●



C

Terminal and alignment brackets

- **Accessory type:** Universal bar clamp systems
- **Material:** Zinc plated steel (sheet), Diecast zinc (clamp)

Figure	Thread size	Material	Model name	Part no.	IM12 Namur	IM18 Namur
	M12	Zinc plated steel (sheet), diecast zinc (clamp)	BEF-KHS-N05	2051611	●	-
	M18		BEF-KHS-N06	2051612	-	●

Intrinsically safe Namur amplifier

Figure	Supply voltage	Output function	Approvals	Model name	Part no.
	AC/DC 24 ... 230 V ¹⁾	2 channels with invertible SPDT relay	II (1) G [Ex ia] IIC II (1) D [Ex iaD] II (3) G Ex nAC [ia] IIC T4 X	EN2-2EX-1	6041096
	DC 19.2 ... 30 V	2 channels with invertible NO relay	II (1) GD [Ex ia] IIC, IIB II (3) G Ex nAC II T4 X	EN2-2EX-3	6041095

C

→ For additional accessories, please see page G-255

C

Analog inductive sensors with triple sensing range for continuous feedback



C



Additional information

Detailed technical dataC-133
 Ordering informationC-134
 Dimensional drawingsC-135
 Connection diagramC-136
 Response curveC-137
 Temperature deratingC-138
 Installation noteC-139
 Recommended accessoriesC-139

Product description

IMA sensors provide a current or voltage output proportional to the target distance. They can be connected to a PLCs analog card. IMA inductive sensors offer an industry-leading triple sensing range and high repeatability.

Combined with industry proven reliability they allow for a huge variety of applications in your industry. The triple sensing range IMA sensors offer reduced

mechanical damage and maintenance costs due to their ability to be mounted further away from the target. IMA sensors are available in 8, 12, 18 and 30 mm cylindrical sizes.

Typical IMA applications include detecting metallic targets, such as tool position; angle measurement and form and pattern identification in metal forming; stretch tension monitoring

At a glance

- Analog output signal is proportional to distance
- Triple sensing distance
- Analog current and voltage signal in one sensor
- High repeatability
- No blind zone

Your benefits

- High positioning accuracy
- High repeatability provides increased machine throughput, less wear and tear, and decreased downtime
- No blind zone – increases machine throughput and efficiency
- Current and voltage output in one sensor requires less inventory of maintenance stock, reducing costs
- Minimal temperature drift provides operational consistency

→ www.mysick.com/en/IMA

For more information, just enter the link or scan the QR code and get direct access to technical data, CAD design models, operating instructions, software, application examples and much more.



Detailed technical data

Features

	IMA08	IMA12	IMA18	IMA30
Housing	M8 x 1	M12 x 1	M18 x 1	M30 x 1.5
Detection range	Quasi-flush	0 ... 4 mm	0 ... 6 mm	0 ... 10 mm
	Non-flush			0 ... 20 mm
Installation type	Quasi-flush		Quasi-flush / non-flush	
Output function	Analog			
Output voltage Q_{A1}	0 V ... 10 V			
Output current Q_{A2}	-		4 mA ... 20 mA	
Enclosure rating ¹⁾	IP 67			
Bandwidth	Quasi-flush	1,600 Hz ²⁾	1,000 Hz ³⁾	500 Hz ⁴⁾
	Non-flush	-	-	200 Hz ⁵⁾

¹⁾ As per EN 60529: 2000-09.

²⁾ -3 dB if s = 2 mm.

³⁾ -3 dB if s = 3 mm.

⁴⁾ -3 dB if s = 5 mm.

⁵⁾ -3 dB if s = 10 mm.

⁶⁾ -3 dB if s = 20 mm.

C

Mechanical / electrical

	IMA08	IMA12	IMA18	IMA30
Supply voltage	15 V DC ... 30 V DC			
Repeatability (T_a not constant)	Quasi-flush	0.3 mm ^{1) 2) 3)}		
	Non-flush	-	0.3 mm ^{1) 2) 3)}	0.6 mm ^{1) 2) 3)}
Repeatability (T_a constant)	Quasi-flush	± 0.01 mm		± 0.05 mm
	Non-flush	-	± 0.05 mm	± 0.1 mm
Resolution	Quasi-flush	≤ 1 μm		≤ 5 μm
	Non-flush	-	≤ 5 μm	≤ 10 μm
Ripple ⁴⁾	≤ 20 %			
Time delay before availability	≤ 60 ms			
Current consumption, no load ⁵⁾	≤ 10 mA	≤ 12 mA		
Load resistance, max.	-	400 Ω ⁶⁾ / 1,000 Ω ⁷⁾		
Connection type	Connector, M12			
Short-circuit protection	✓			
Reverse polarity protection	✓			
Ambient operating temperature	-25 °C ... +70 °C	-	-25 °C ... +70 °C ^{8) 9)}	
Housing material	Metal, Nickel-plated brass			
Housing cap material	Plastic, PBTP			

	IMA08	IMA12	IMA18	IMA30
Reduction factor R_m	The values are reference values which may vary			
Stainless steel (V2A, 304)				
Quasi-flush	0.68	0.47	0.6	0.65
Non-flush	–		0.69	0.8
Aluminum (Al)				
Quasi-flush	0.28		0.18	0.2
Non-flush	–		0.38	0.4
Copper (Cu)				
Quasi-flush	0.25	0.2	0.15	0.17
Non-flush	–		0.36	0.4
Brass (Br)				
Quasi-flush	0.4	0.35	0.28	0.3
Non-flush	–		0.46	0.5

¹⁾ As per IEC 60947-5-2.

²⁾ $U_b = DC 20 \dots 30 V$.

³⁾ $T_A = 23 \text{ }^\circ\text{C} \pm 5 \text{ }^\circ\text{C}$.

⁴⁾ Of V_s .

⁵⁾ Without load.

⁶⁾ $U_b = 15 V$.

⁷⁾ $U_b = 30 V$.

⁸⁾ QA1 loaded, QA2 unloaded.

⁹⁾ QA1 loaded, QA2 loaded: see temperature reduction.

C

Ordering information

IMA08

- **Housing:** M8 x 1
- **Repeat accuracy:** 0.3 mm (As per IEC 60947-5-2.) ($U_b = DC 20 \dots 30 V$.) ($T_A = 23 \text{ }^\circ\text{C} \pm 5 \text{ }^\circ\text{C}$.)
- **Connection:** Connector M12, 4-pin

Detection range	Installation	Repeatability (T_a constant)	Time delay before availability	Connection diagram	Model name	Part no.
0 mm ... 4 mm	Quasi-flush	$\pm 0.01 \text{ mm}$	$\leq 50 \text{ ms}$	Cd-021	IMA08-04BE3ZCOK	6041782

IMA12

- **Housing:** M12 x 1
- **Repeat accuracy:** 0.3 mm (As per IEC 60947-5-2.) ($U_b = DC 20 \dots 30 V$.) ($T_A = 23 \text{ }^\circ\text{C} \pm 5 \text{ }^\circ\text{C}$.)
- **Connection:** Connector M12, 4-pin

Detection range	Installation	Repeatability (T_a constant)	Time delay before availability	Connection diagram	Model name	Part no.
0 mm ... 6 mm	Quasi-flush	$\pm 0.01 \text{ mm}$	$\leq 50 \text{ ms}$	Cd-021	IMA12-06BE3ZCOK	6041792

IMA18

- **Housing:** M18 x 1
- **Repeat accuracy:** 0.3 mm (As per IEC 60947-5-2.) ($U_b = DC 20 \dots 30 V$.) ($T_A = 23 \text{ }^\circ\text{C} \pm 5 \text{ }^\circ\text{C}$.)
- **Connection:** Connector M12, 4-pin

Detection range	Installation	Repeatability (T_a constant)	Time delay before availability	Connection diagram	Model name	Part no.
0 mm ... 10 mm	Quasi-flush	$\pm 0.02 \text{ mm}$	$\leq 50 \text{ ms}$	Cd-022	IMA18-10BE1ZCOK	6041793
0 mm ... 20 mm	Non-flush	$\pm 0.05 \text{ mm}$	$\leq 60 \text{ ms}$	Cd-022	IMA18-20NE1ZCOK	6041794

IMA30

- **Housing:** M30 x 1.5
- **Time delay before availability:** ≤ 50 ms
- **Connection:** Connector M12, 4-pin

Detection range	Installation	Repeat accuracy ^{1) 2) 3)}	Repeatability (T _a constant)	Connection diagram	Model name	Part no.
0 mm ... 20 mm	Quasi-flush	0.3 mm	± 0.05 mm	Cd-022	IMA30-20BE1ZCOK	6041795
0 mm ... 40 mm	Non-flush	0.6 mm	± 0.1 mm	Cd-022	IMA30-40NE1ZCOK	6041796

¹⁾ As per IEC 60947-5-2.

²⁾ U_b = DC 20 ... 30 V.

³⁾ T_A = 23 °C + -5 °C.

Dimensional drawings

IMA08-xxBxxxCOK, M8, quasi-flush

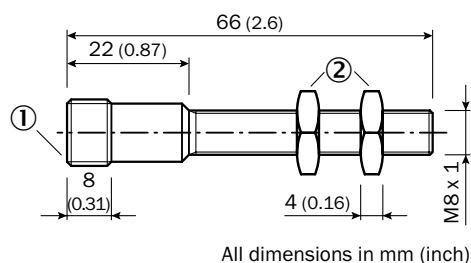

- ① Connection
- ② Fastening nuts (2x), 13 mm hex, metal

IMA12-xxBxxxCOK, M12, quasi-flush

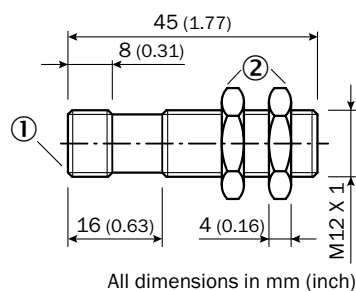

- ① Connection
- ② Fastening nuts (2 x); width across 17, metal

IMA18-xxBxxxCOK, M18, quasi-flush

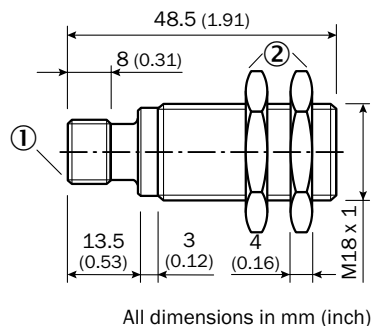

- ① Connection
- ② Fastening nuts (2 x); 24 mm hex, metal

IMA18-xxNxxxCOK, M18, non-flush

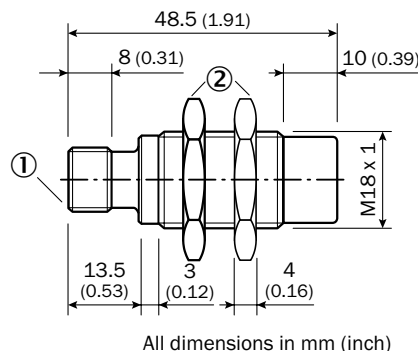

- ① Connection
- ② Fastening nuts (2 x); 24 mm hex, metal

C

**IMA30-xxBxxxC0K,
M30, quasi-flush**

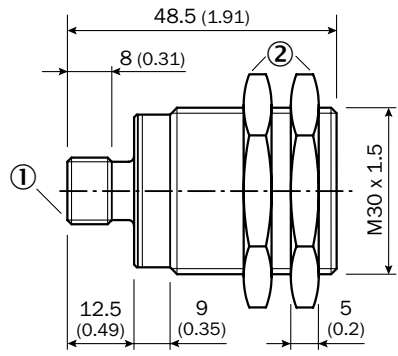

All dimensions in mm (inch)

- ① Connection
- ② Fastening nuts (2 x); 36 mm hex, metal

**IMA30-xxNxxxC0K,
M30, non-flush**

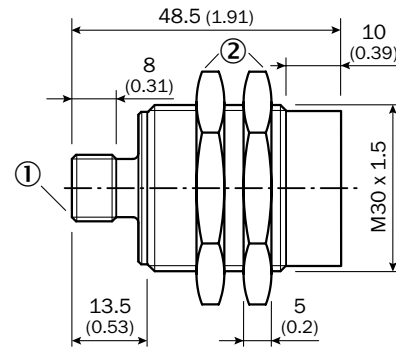

All dimensions in mm (inch)

- ① Connection
- ② Fastening nuts (2 x); 36 mm hex, metal

C

Connection diagram

Cd-021

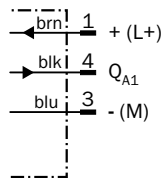

Cd-022

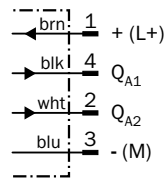

Response curve

IMA08

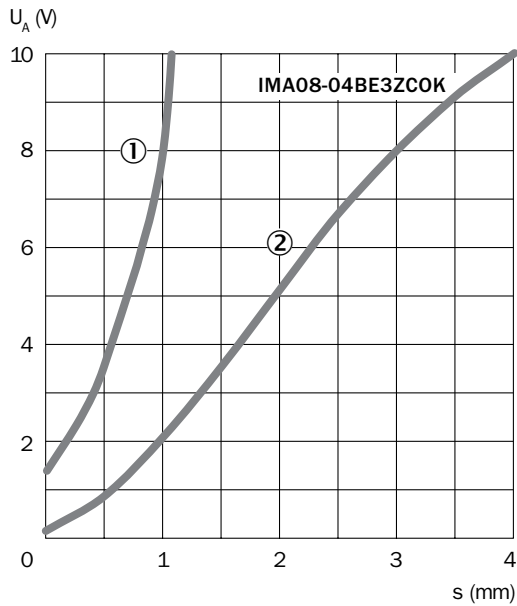

- ① Aluminium (AL)
- ② St37 (FE)

IMA12

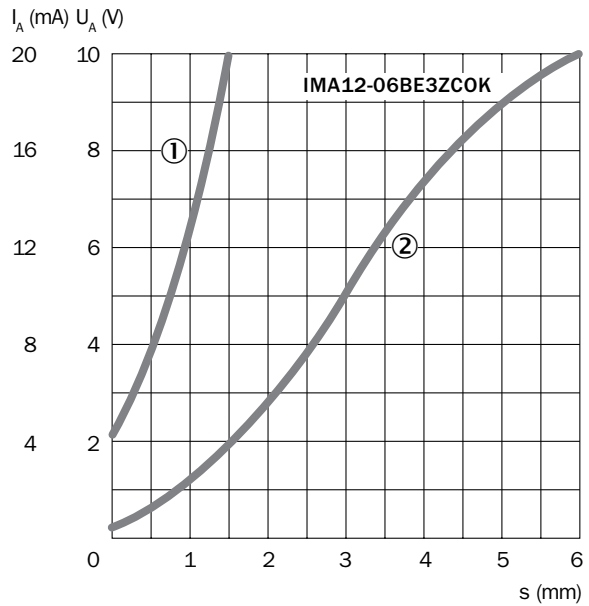

- ① Aluminium (AL)
- ② St37 (FE)

IMA18-xxBxxxxxx,
M18, quasi-flush

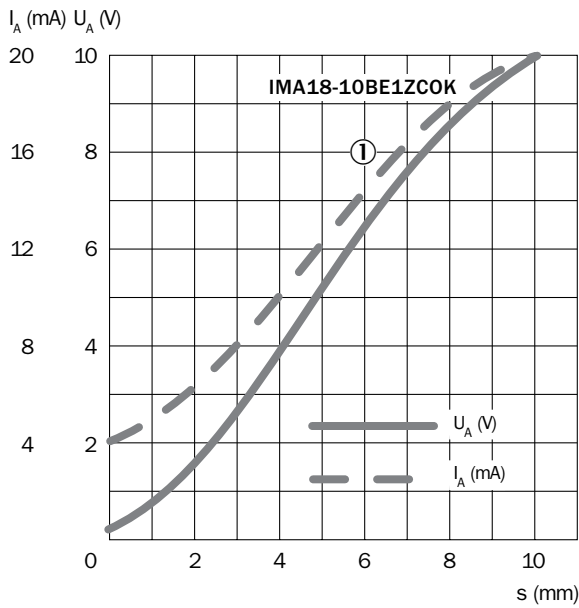

- ① St37 (FE)

IMA18-xxNxxxxxx,
M18, non-flush

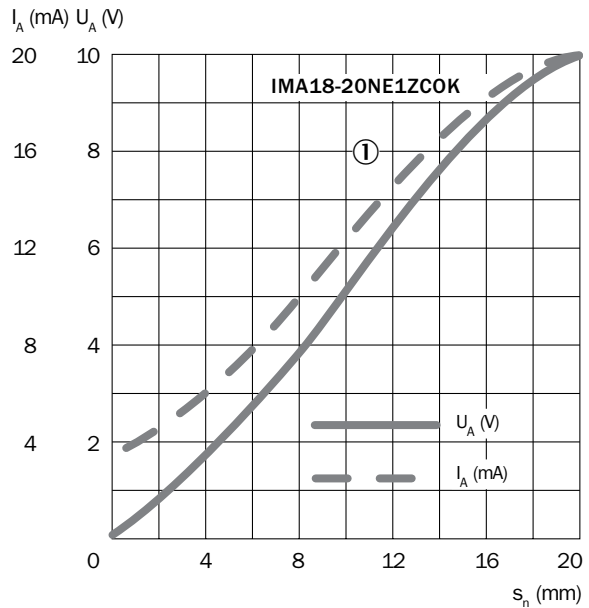

**IMA30-xxBxxxxxx,
M30, quasi-flush**

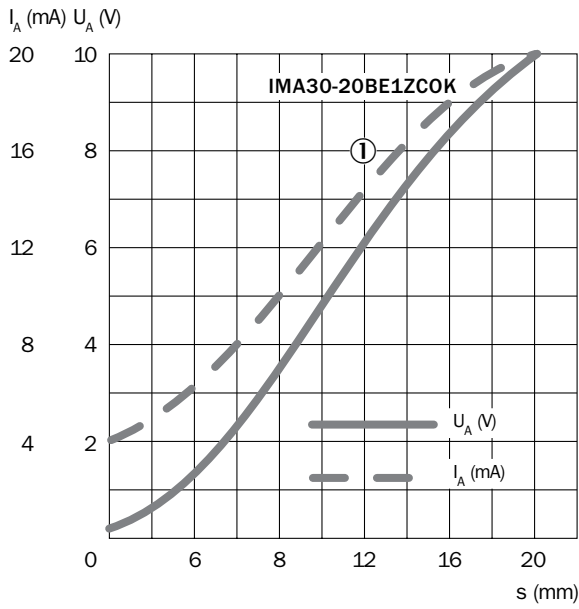

① St37 (FE)

**IMA30-xxNxxxxxx,
M30, non-flush**

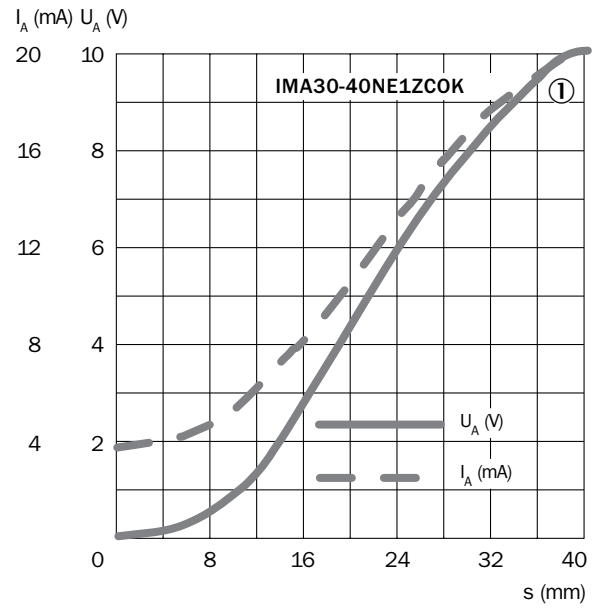

① St37 (FE)

C

Temperature derating

IMA18, IMA30

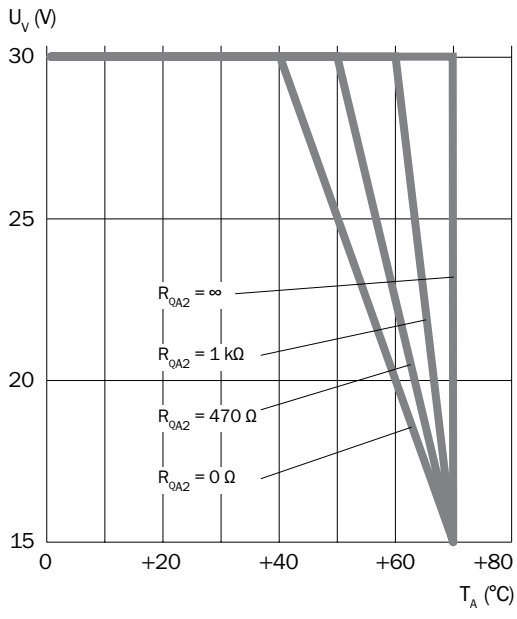

Installation note

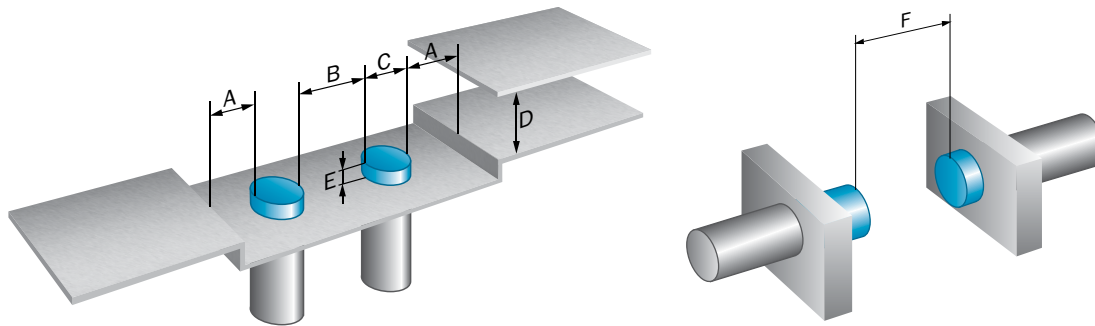

	A	B	C	D	E	F
IMA08-xxBxxxxxx	4 mm	12 mm	8 mm	12 mm	1 mm	40 mm
IMA12-xxBxxxxxx	6 mm	18 mm	12 mm	18 mm	2 mm	60 mm
IMA18-xxBxxxxxx	10 mm	26 mm	18 mm	30 mm	4 mm	100 mm
IMA18-xxNxxxxxx	21 mm	60 mm	18 mm	60 mm	20 mm	200 mm
IMA30-xxBxxxxxx	25 mm	50 mm	30 mm	60 mm	6 mm	200 mm
IMA30-xxNxxxxxx	40 mm	120 mm	30 mm	120 mm	Aluminum: 25 mm Steel: 35 mm Brass: 25 mm Stainless steel: 20 mm	400 mm

C

Recommended accessories

Mounting brackets





- **Accessory type:** Mounting brackets
- **Material:** Steel, zinc coated

Figure	Thread size	Configuration	Model name	Part no.	IMA08	IMA12	IMA18	IMA30
	M8	Right angle	BEF-WN-M08	5321721	●	-	-	-
	M12	Right angle	BEF-WN-M12	5308447	-	●	-	-
	M18	Right angle	BEF-WN-M18	5308446	-	-	●	-
	M30	Right angle	BEF-WN-M30	5308445	-	-	-	●

Cordsets and connectors

Connector M12, 4-pin

- Connector type: Female connector

Figure	Enclosure rating	Configuration	Jacket material	Cable length	Model name	Part no.
	IP 67	Straight	PVC	2 m	DOL-1204-G02M	6009382
				5 m	DOL-1204-G05M	6009866
	IP 68	Straight	PUR halogen free	2 m	DOL-1204-G02MC	6025900
				5 m	DOL-1204-G05MC	6025901
	IP 67	Right angle	PVC	2 m	DOL-1204-W02M	6009383
				5 m	DOL-1204-W05M	6009867
	IP 68	Right angle	PUR halogen free	2 m	DOL-1204-W02MC	6025903
				5 m	DOL-1204-W05MC	6025904

C

Terminal and alignment brackets

Figure	Description	Thread size	Material	Model name	Part no.	IMA08	IMA12	IMA18
	Terminal brackets, without fixed stop	M8	Plastic (PA12), glass-fiber reinforced	BEF-KH-M08	2051477	●	-	-
		M12		BEF-KH-M12	2051479	-	●	-
		M18		BEF-KH-M18	2051481	-	-	●
	Terminal brackets, with fixed stop	M8		BEF-KHF-M08	2051478	●	-	-
		M12		BEF-KHF-M12	2051480	-	●	-
		M18		BEF-KHF-M18	2051482	-	-	●
	Universal bar clamp systems	M12	Zinc plated steel (sheet), Diecast zinc (clamp)	BEF-KHS-N05	2051611	-	●	-
		M18		BEF-KHS-N06	2051612	-	-	●
	Alignment brackets	M18	Plastic	BEF-WN-M18-ST02	5312973	-	-	●

→ For additional accessories, please see page G-255

C

Space-saving miniature smooth inductive sensors



Product description

The IH Miniature inductive sensors save installation space due to their miniature design. They are ideal for highly dynamic applications in robotics, handling, and

assembly. Plus, they are enclosed in a rugged stainless steel housing with either a 3 or 4 mm diameter.

At a glance

- Small housing and light weight
- Housing diameters of 3 and 4 mm
- Integrated LED indicator
- Rugged IP 67- rated stainless steel housing
- Flexible connectivity via connecting cable or connector

Your benefits

- Space-saving installation in space-critical applications provides a high degree of design freedom
- Reliable detection of high-speed processes increases machine throughput
- High-visibility indicator LED ensures simple monitoring of the operational state
- High positioning accuracy
- High resistance to shock and vibrations increases service life and reduces maintenance and replacement costs



Additional information

Detailed technical dataC-142
 Ordering informationC-144
 Dimensional drawingsC-144
 Connection diagramC-145
 Installation noteC-145
 Recommended accessoriesC-146

→ www.mysick.com/en/IH_Miniature
 For more information, just enter the link or scan the QR code and get direct access to technical data, CAD design models, operating instructions, software, application examples and much more.



C

Detailed technical data

Features

	IH03	IH04
Diameter	3 mm	4 mm
Sensing range S_n	0.6 mm	0.8 mm
Assured sensing range S_a	0.486 mm	0.648 mm
Installation type	Flush	
Switching frequency	5,000 Hz	
Output type	NPN / PNP	
Output function	NO / NC	NO
Electrical wiring	DC 3-wire	
Enclosure rating ¹⁾	IP 67	

¹⁾ According to EN60529.

Mechanical / electrical

	IH03	IH04
Supply voltage	10 V DC ... 30 V DC	
Ripple ¹⁾	≤ 20 %	
Voltage drop	≤ 2 V ²⁾	≤ 2 V ³⁾
Current consumption ⁴⁾	≤ 10 mA	
Time delay before availability	≤ 10 ms	
Hysteresis	0 % ... 10 %	
Repeatability ⁵⁾	≤ 2 %	≤ 1.5 %
Temperature drift (% of S_r)	± 10 %	
EMC	According to EN 60947-5-2	
Output current I_a	≤ 100 mA	≤ 200 mA
Connection type	Cable, 2 m, PUR / Cable with connector and knurled nuts, M8, 0.2 m, PUR	Connector, M8 / Cable, 3-wire, 2 m, PVC / Cable with connector, 2 m, PVC
Short-circuit protection	✓	
Reverse polarity protection	✓	
Power-up pulse protection	-	✓
Shock/vibration	30 g, 11 ms/10 ... 55 Hz, 1 mm	
Ambient operating temperature	-25 °C ... +70 °C	
Housing material	Stainless steel	
Housing cap material	Plastic, Polyester	Plastic, PA 66
Reduction factor R_m	The values are reference values which may vary	
Stainless steel (V2A, 304)	0.8	0.8
Aluminum (solid)	0.55	0.5
Copper (Cu)	0.5	0.45
Brass	0.65	0.55

¹⁾ Of V_S .

²⁾ With $I_a = 100$ mA.

³⁾ With $I_a = 200$ mA.

⁴⁾ Without load.

⁵⁾ $U_b = 20 \dots 30$ VDC, $T_a = 23 \text{ °C} \pm 5 \text{ °C}$.

C

Ordering information

IH03

- Diameter: 3 mm
- Installation: flush

Sensing range S_n	Output type	Output function	Connection	Connection diagram	Model name	Part no.
0.6 mm	PNP	NO	Cable, 3-wire	Cd-001	IH03-0B6PS-VU1	6020141
			Cable with connector M8, 3-pin, with knurled nuts	Cd-002	IH03-0B6PS-VR1	6038602
	NPN	NO	Cable, 3-wire	Cd-003	IH03-0B6PO-VU1	6020143
			Cable, 3-wire	Cd-001	IH03-0B6NS-VU1	6020142

IH04

- Diameter: 4 mm
- Installation: flush

Sensing range S_n	Output type	Output function	Connection	Connection diagram	Model name	Part no.
0.8 mm	PNP	NO	Connector M8, 3-pin	Cd-002	IH04-0B8PS-VT1	6020114
			Cable, 3-wire	Cd-001	IH04-0B8PS-VW1	6020113
			Cable with connector M8, 3-pin	Cd-001	IH04-0B8PS-VR1	6045178
	NPN	NO	Connector M8, 3-pin	Cd-002	IH04-0B8NS-VT1	6020152
			Cable, 3-wire	Cd-001	IH04-0B8NS-VW1	6020149

Dimensional drawings

IH03, flush, cable

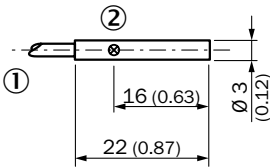

All dimensions in mm (inch)

- ① Connection
- ② LED indicator

IH04-xBxxx-xT1, flush, connector

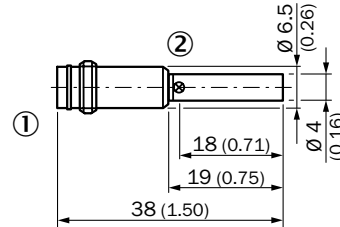

All dimensions in mm (inch)

- ① Connection
- ② LED indicator

IH04-xBxxx-xW1, IH04-xBxxx-xR1, flush, cable, cable with connector

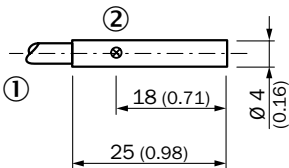

All dimensions in mm (inch)

- ① Connection
- ② LED indicator

Connection diagram

Cd-001

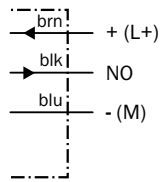

Cd-002

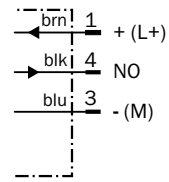

Cd-003

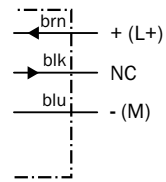

Installation note

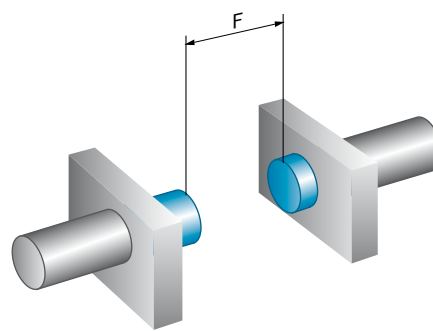
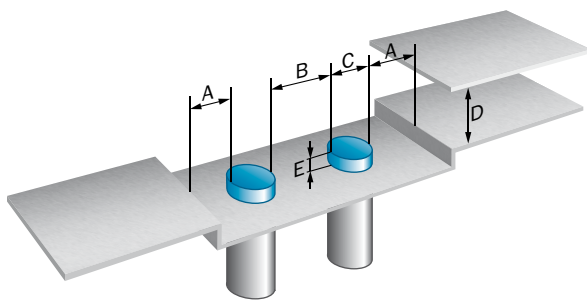

C

	A	B	C	D	E	F
IH03	0.5 mm	0 mm	3 mm	1.8 mm	0 mm	5 mm

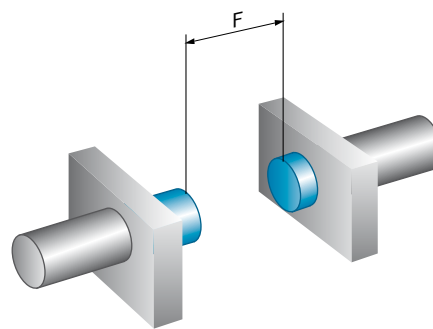
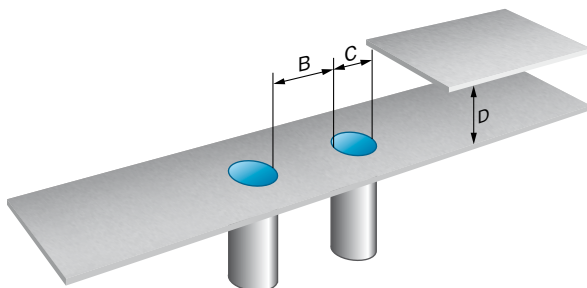





	B	C	D	F
IH04	0 mm	4 mm	2.4 mm	7 mm

Recommended accessories

Cordsets and connectors

Connector M8, 3-pin

- Connector type: Female connector
- Enclosure rating: IP 67

Figure	Configuration	Jacket material	Cable length	Model name	Part no.
	Straight	PVC	2 m	DOL-0803-G02M	6010785
			5 m	DOL-0803-G05M	6022009
	Right angle	PVC	2 m	DOL-0803-W02M	6008489
			5 m	DOL-0803-W05M	6022010
	Straight	PBT	-	DOS-0803-G	7902077
	Right angle	PBT	-	DOS-0803-W	7902078

→ For additional accessories, please see page G-255

C

C

Smooth cylindrical housing for time-saving installations



Product description

The IH Standard family of inductive proximity sensors meets the most important requirements for inductive sensors, including precision, less downtime and a long service life. With the help of integrated ASIC technology and the latest

manufacturing advancements, standard housings meet these requirements effortlessly. Tried and tested in everyday use, these sensors are the first choice when it comes to finding a solution for your application.

At a glance

- Operating distance up to 30 mm
- High switching frequencies up to 5 kHz
- DC and AC/DC versions available
- Plastic and stainless steel housing
- Available in short and standard housing lengths

Your benefits

- Reliable detection of high-speed processes increases machine throughput
- High-visibility indicator LED ensures simple monitoring of the operational state
- High resistance to shock and vibrations increases service life and reduces maintenance and replacement costs



Additional information

Detailed technical dataC-149

Ordering informationC-150

Dimensional drawingsC-152

Connection diagramC-154

Installation noteC-154

Recommended accessoriesC-155

→ www.mysick.com/en/IH_Standard

For more information, just enter the link or scan the QR code and get direct access to technical data, CAD design models, operating instructions, software, application examples and much more.



Detailed technical data

Features

	IH06	IH20	IH34
Diameter	6.5 mm	20 mm	34 mm
Sensing range S_n			
Short-body housing, flush	1.5 mm / 2 mm	–	
Standard, non-flush	4 mm	10 mm	30 mm
Assured sensing range S_a			
Short-body housing, flush	1.215 mm / 1.62 mm	–	
Standard, non-flush	3.24 mm	8.1 mm	24.3 mm
Installation in metal	Flush / Non-flush	Non-flush	
Output type	NPN / PNP	–	
Output function	NO / NC	NC / NO	
Electrical wiring	DC 3-wire	AC/DC 2-wire	
Enclosure rating ³⁾	IP 67		

¹⁾ AC. ²⁾ DC. ³⁾ According to EN60529.

C

Mechanical / electrical

	IH06	IH20	IH34
Supply voltage	10 V DC ... 30 V DC	20 V AC/DC ... 250 V AC/DC	
Voltage drop	$\leq 2 \text{ V}^{1)}$ / $\leq 1.8 \text{ V}^{1)}$	$\leq 6.5 \text{ V (AC)}$ $\leq 6 \text{ V (DC)}$	
Power consumption	$\leq 10 \text{ mA}^{2)}$	–	
Temperature drift (% of S_p)	$\pm 10 \%$		
EMC	According to EN 60947-5-2	According to EN 60947-5-2, As per EN 55011 class B	
Output current I_a	$\leq 200 \text{ mA}$	$\leq 350 \text{ mA, AC (+50 °C)}$ $\leq 250 \text{ mA, AC (+80 °C)}$ $\leq 100 \text{ mA, DC}$	
Residual current	–	$\leq 2.5 \text{ mA (AC 250 V)}$ $\leq 1.3 \text{ mA (AC 110V)}$ $\leq 0.8 \text{ mA (DC 24 V)}$	
Intermittent current	–	2.2 A ³⁾	
Connection type	Connector, M8, 3-pin / Cable, 2 m, PVC	Cable, 2 m, PVC	
Short-circuit protection	✓	– ⁷⁾	
Reverse polarity protection	✓	–	
Shock/vibration	30 g, 11 ms/10 ... 55 Hz, 1 mm		
Ambient operating temperature	–25 °C ... +70 °C	–25 °C ... +80 °C	
Housing material	Stainless steel, V2A	Plastic, PBT	
Housing cap material	Plastic, PBT		

	IH06	IH20	IH34
Reduction factor R_m	The values are reference values which may vary		
Stainless steel (V2A)			
Short-body housing, flush	0.8 / 0.6	-	
Standard, flush	0.6	-	
Non-flush	0.77	0.7	
Aluminum (Al)			
Short-body housing, flush	0.45 / 0.17	-	
Standard, flush	0.17	-	
Non-flush	0.47	0.3	
Copper (Cu)			
Short-body housing, flush	0.4 / 0.1	-	
Standard, flush	0.1	-	
Non-flush	0.42	0.2	
Brass (Br)			
Short-body housing, flush	0.5 / 0.25	-	
Standard, flush	0.25	-	
Non-flush	0.52	0.4	

¹⁾ With $I_a = 200$ mA.

²⁾ Without load.

³⁾ 20 ms/ 0.5 Hz.

⁴⁾ Miniature fuse as per IEC 60217-2 Sheet 1, ≤ 2 A (quick-blow).

Ordering information

IH06, Sensing range S_n 1.5 mm

- **Installation:** flush
- **Repeatability:** ≤ 1.5 %
- **Residual ripple:** ≤ 20 %
- **Time delay before availability:** ≤ 10 ms
- **Hysteresis:** ≤ 10 %
- **Voltage drop:** ≤ 2 V

Output type	Output function	Housing	Switching frequency	Connection	Connection diagram	Model name	Part no.
NPN	NO	Short-body housing	5,000 Hz	Connector M8, 3-pin	Cd-002	IH06-1B5NS-VTK	6020170
				Cable, 3-wire, 2 m, PVC	Cd-001	IH06-1B5NS-VWK	6020166
PNP	NO	Short-body housing	5,000 Hz	Connector M8, 3-pin	Cd-002	IH06-1B5PS-VTK	6020169
				Cable, 3-wire, 2 m, PVC	Cd-001	IH06-1B5PS-VWK	6020165
	NC	Short-body housing	5,000 Hz	Connector M8, 3-pin	Cd-004	IH06-1B5PO-VTK	6020171
				Cable, 3-wire, 2 m, PVC	Cd-003	IH06-1B5PO-VWK	6020167

IH06, Sensing range S_n 2 mm

- **Installation:** flush
- **Repeatability:** $\leq 5\%$
- **Residual ripple:** $\leq 10\%$
- **Power-up pulse suppression:** ✓
- **Time delay before availability:** ≤ 50 ms
- **Hysteresis:** 1 % ... 20 %
- **Voltage drop:** ≤ 1.8 V

Output type	Output function	Housing	Switching frequency	Connection	Connection diagram	Model name	Part no.
NPN	NO	Standard	5,000 Hz	Connector M8, 3-pin	Cd-002	IH06-02BNS-VT1	7900180
				Cable, 3-wire, 2 m, PVC	Cd-001	IH06-02BNS-VW1	7900178
		Short-body housing	3,000 Hz	Connector M8, 3-pin	Cd-002	IH06-02BNS-VTK	6025878
				Cable, 3-wire, 2 m, PVC	Cd-001	IH06-02BNS-VWK	6025875
PNP	NO	Standard	5,000 Hz	Connector M8, 3-pin	Cd-002	IH06-02BPS-VT1	7900179
				Cable, 3-wire, 2 m, PVC	Cd-001	IH06-02BPS-VW1	7900177
		Short-body housing	3,000 Hz	Connector M8, 3-pin	Cd-002	IH06-02BPS-VTK	6025877
				Cable, 3-wire, 2 m, PVC	Cd-001	IH06-02BPS-VWK	6025874
	NC	Standard	5,000 Hz	Connector M8, 3-pin	Cd-004	IH06-02BPO-VT1	1016857
				Short-body housing	3,000 Hz	Connector M8, 3-pin	Cd-004

C

IH06, Sensing range S_n 4 mm

- **Installation:** non-flush
- **Repeatability:** $\leq 5\%$
- **Residual ripple:** $\leq 10\%$
- **Power-up pulse suppression:** ✓
- **Time delay before availability:** ≤ 50 ms
- **Hysteresis:** 1 % ... 20 %
- **Voltage drop:** ≤ 1.8 V

Output type	Output function	Housing	Switching frequency	Connection	Connection diagram	Model name	Part no.
NPN	NO	Standard	1,800 Hz	Cable, 3-wire, 2 m, PVC	Cd-001	IH06-04NNS-VW1	7900182
		Short-body housing	2,500 Hz	Connector M8, 3-pin	Cd-002	IH06-04NNS-VTK	6025883
				Cable, 3-wire, 2 m, PVC	Cd-001	IH06-04NNS-VWK	6025881
PNP	NO	Standard	1,800 Hz	Connector M8, 3-pin	Cd-002	IH06-04NPS-VT1	7900183
				Cable, 3-wire, 2 m, PVC	Cd-001	IH06-04NPS-VW1	7900181
		Short-body housing	2,500 Hz	Connector M8, 3-pin	Cd-002	IH06-04NPS-VTK	6025882
				Cable, 3-wire, 2 m, PVC	Cd-001	IH06-04NPS-VWK	6025880
	NC	Short-body housing	2,500 Hz	Connector M8, 3-pin	Cd-004	IH06-04NPO-VTK	6025884

IH20, Sensing range S_n 10 mm

- **Installation:** non-flush
- **Hysteresis:** 1 % ... 15 %

Output function	Housing	Switching frequency	Connection	Connection diagram	Model name	Part no.
NC	Standard	25 Hz, 70 Hz	Cable, 2-wire, 2 m, PVC	Cd-012	IH20-10NUO-KU0	7902131
NO	Standard	25 Hz, 70 Hz	Cable, 2-wire, 2 m, PVC	Cd-012	IH20-10NUS-KU0	7902130

IH34, Sensing range S_n 30 mm

- Installation: non-flush
- Hysteresis: 1 % ... 15 %

Output function	Housing	Switching frequency	Connection	Connection diagram	Model name	Part no.
NC	Standard	25 Hz, 50 Hz	Cable, 2-wire, 2 m, PVC	Cd-012	IH34-30NUO-KUO	7902135
NO	Standard	25 Hz, 50 Hz	Cable, 2-wire, 2 m, PVC	Cd-012	IH34-30NUS-KUO	7902134

Dimensional drawings

IH06-1B5xx-xTK,
flush, $S_n = 1.5$ mm, connector, short-body housing

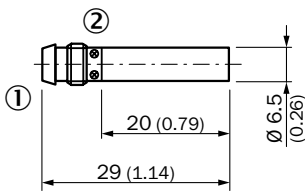

All dimensions in mm (inch)

- ① Connection
- ② LED indicator

IH06-1B5xx-xWK,
flush, $S_n = 1.5$ mm, cable, short-body housing

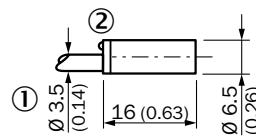

All dimensions in mm (inch)

- ① Connection
- ② LED indicator

IH06-02Bxx-xT1,
flush, $S_n = 2$ mm, connector, standard

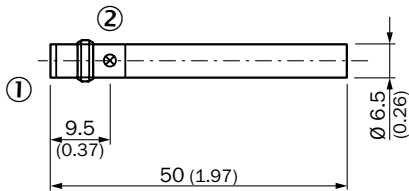

All dimensions in mm (inch)

- ① Connection
- ② LED indicator

IH06-02Bxx-xW1,
flush, $S_n = 2$ mm, cable, standard

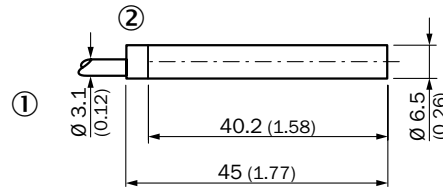

All dimensions in mm (inch)

- ① Connection
- ② LED indicator

IH06-02Bxx-xTK,
flush, $S_n = 2$ mm, connector, short-body housing

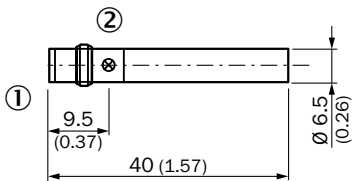

All dimensions in mm (inch)

- ① Connection
- ② LED indicator

IH06-02Bxx-xWK,
flush, $S_n = 2$ mm, cable, short-body housing

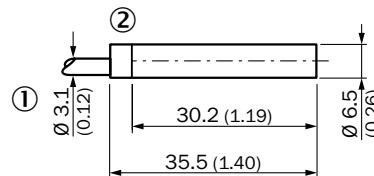

All dimensions in mm (inch)

- ① Connection
- ② LED indicator

IH06-04Nxx-xW1,
non-flush, Sn = 4 mm, cable, standard

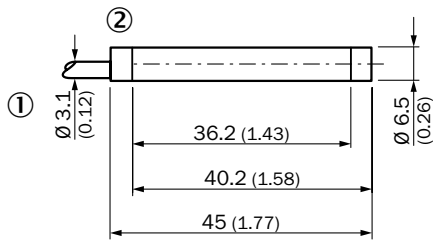

All dimensions in mm (inch)

- ① Connection
- ② LED indicator

IH06-04Nxx-xTK,
non-flush, Sn = 4 mm, connector, short-body housing

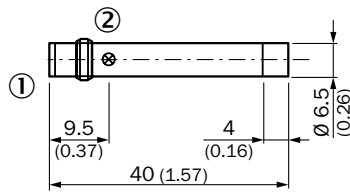

All dimensions in mm (inch)

- ① Connection
- ② LED indicator

IH06-04Nxx-xWK,
non-flush, Sn = 4 mm, cable, short-body housing

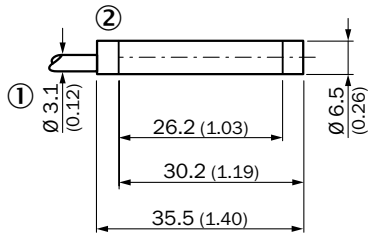

All dimensions in mm (inch)

- ① Connection
- ② LED indicator

IH06-04Nxx-xT1,
non-flush, Sn = 4 mm, connector, standard

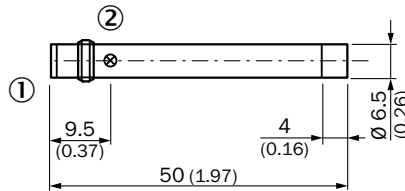

All dimensions in mm (inch)

- ① Connection
- ② LED indicator

IH20-10Nxx-xU0,
non-flush, Sn = 10 mm, cable, standard

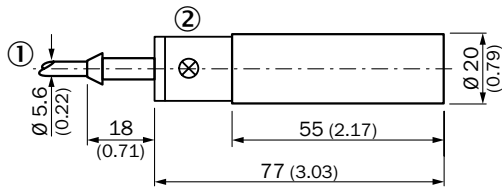

All dimensions in mm (inch)

- ① Connection
- ② LED indicator

IH34-30Nxx-xU0,
non-flush, Sn = 30 mm, cable, standard

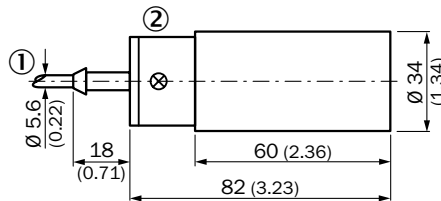

All dimensions in mm (inch)

- ① Connection
- ② LED indicator

C

Connection diagram

Cd-001

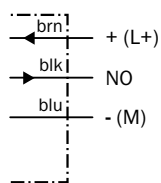

Cd-002

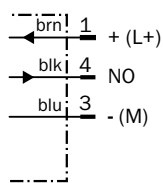

Cd-003

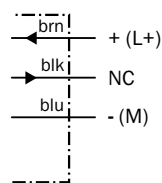

Cd-004

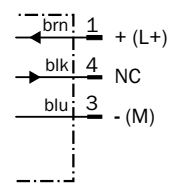

Cd-012

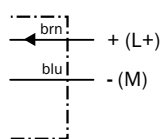

C

Installation note

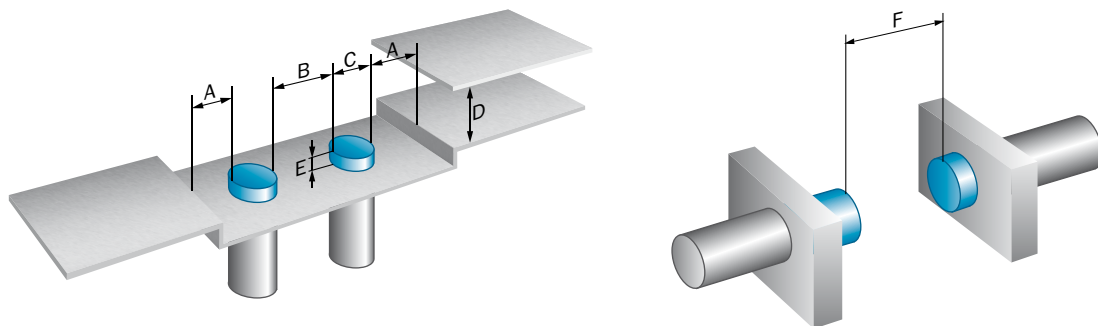





	Installation type	Sensing range Sn	A	B	C	D	E	F
IH06-1B5xx-xxK	Flush	1.5 mm	1.75 mm	3 mm	6.5 mm	4.5 mm	0 mm	12 mm
IH06-02Bxx-xxx	Flush	2 mm	3.25 mm	6.5 mm	6.5 mm	6 mm	4 mm	16 mm
IH06-04Nxx-xxx	Non-flush	4 mm	6.5 mm	13 mm	6.5 mm	12 mm	6 mm	32 mm
IH20	Non-flush	10 mm	20 mm	40 mm	20 mm	30 mm	20 mm	80 mm
IH34	Non-flush	20 mm	34 mm	68 mm	34 mm	90 mm	60 mm	240 mm

Recommended accessories

Cordsets and connectors

Connector M8, 3-pin

- Connector type: Female connector
- Enclosure rating: IP 67

Figure	Configuration	Jacket material	Cable length	Model name	Part no.
	Straight	PVC	2 m	DOL-0803-G02M	6010785
			5 m	DOL-0803-G05M	6022009
	Right angle	PVC	2 m	DOL-0803-W02M	6008489
			5 m	DOL-0803-W05M	6022010
	Straight	PBT	-	DOS-0803-G	7902077
	Right angle	PBT	-	DOS-0803-W	7902078

C

Terminal and alignment brackets

Figure	Description	Material	Model name	Part no.
	Clamp bracket	Plastic	BEF-S-H06	7901771

→ For additional accessories, please see page G-255

Rectangular, small and space-saving



C



Additional information

Detailed technical dataC-157
 Ordering informationC-158
 Dimensional drawingsC-159
 Connection diagramC-160
 Installation noteC-161
 Recommended accessoriesC-161

Product description

The IQ Miniature is a rectangular inductive proximity sensor family distinguished by its high performance levels and small space requirements. These sensors' compact dimensions enable them to be

easily integrated into applications where space is critical. In addition, the IQ Miniature line offers high sensor performance for demanding applications.

At a glance

- Long sensing distance
- Rugged metal and plastic housings
- Narrow design: 5 x 5 or 8 x 8 mm
- Compact, space-saving design

Your benefits

- Trouble-free installation in space-critical applications
- Reliable detection of fast processes
- Quick installation without any fine adjustments
- Long sensing distance reduces mechanical damage
- Maintenance cost reduction due to increased sensor life
- High resistance to shock and vibrations

→ www.mysick.com/en/IQ_Miniature

For more information, just enter the link or scan the QR code and get direct access to technical data, CAD design models, operating instructions, software, application examples and much more.



Detailed technical data

Features

	IQ05	IQ08
Dimensions (W x H x D)	5 mm x 5 mm x 25 mm	8 mm x 8 mm x 40 mm
Sensing range S_n		
Flush	0.8 mm	2 mm
Non-flush	-	4 mm
Assured sensing range S_a		
Flush	0.64 mm	1.62 mm
Non-flush	-	3.24 mm
Installation type	Flush	Flush / Non-flush
Switching frequency	2,000 Hz	
Output type	NPN / PNP	
Output function	NO / NC	
Electrical wiring	DC 3-wire	
Enclosure rating ¹⁾	IP 67	

¹⁾ According to EN60529.

Mechanical / electrical

	IQ05	IQ08
Supply voltage	10 V DC ... 30 V DC	
Ripple ¹⁾	≤ 20 %	≤ 10 %
Voltage drop ²⁾	≤ 2 V	
Current consumption ³⁾	≤ 10 mA	
Time delay before availability	≤ 10 ms	≤ 100 ms
Hysteresis	1 % ... 10 %	5 % ... 15 %
Repeatability	≤ 1.5 % ⁴⁾	≤ 2 % ^{4) 5)}
Temperature drift (% of S_p)	± 10 %	
EMC	According to EN 60947-5-2	
Output current I_a	≤ 200 mA	
Connection type	Cable, 2 m, PUR	Connector, M8 / Cable, 2 m, PVC
Short-circuit protection	✓	
Reverse polarity protection	✓	
Power-up pulse protection	✓	
Shock/vibration	30 g, 11 ms/10 ... 55 Hz, 1 mm	
Ambient operating temperature	-25 °C ... +70 °C	-25 °C ... +75 °C
Housing material	Metal, Chrome-plated brass	Plastic, VISTAL™
Sensing face material	Plastic, Polyester	Plastic, VISTAL™
Tightening torque, max.	-	2 Nm

	IQ05	IQ08
Reduction factor R_m	The values are reference values which may vary	
Stainless steel (V2A, 304)		
Flush	0.85	0.7
Non-flush	–	0.7
Aluminum (Al)		
Flush	0.6	0.3
Non-flush	–	0.5
Copper (Cu)		
Flush	0.6	0.2
Non-flush	–	0.4
Brass (Br)		
Flush	0.7	0.3
Non-flush	–	0.5

¹⁾ Of V_s .

²⁾ At I_a max.

³⁾ Without load.

⁴⁾ $U_b = 20 \dots 30$ VDC, $T_a = 23 \text{ °C} \pm 5 \text{ °C}$.

⁵⁾ Of Sr.

Ordering information

IQ05

- **Housing:** 5 mm x 5 mm x 25 mm

Sensing range S_n	Installation	Output function	Output type	Connection	Connection diagram	Model name	Part no.
0.8 mm	Flush	NO	PNP	Cable, 3-wire, 2 m, PUR	Cd-001	IQ05-0B8PS-ZU1	6020161
			NPN	Cable, 3-wire, 2 m, PUR	Cd-001	IQ05-0B8NS-ZU1	6020162
		NC	PNP	Cable, 3-wire, 2 m, PUR	Cd-003	IQ05-0B8PO-ZU1	6020163

IQ08

- **Housing:** 8 mm x 8 mm x 40 mm

Sensing range S_n	Installation	Output function	Output type	Connection	Connection diagram	Model name	Part no.
2 mm	Flush	NO	PNP	Connector M8, 3-pin	Cd-002	IQ08-02BPSKT0S	1055494
				Cable, 3-wire, 2 m, PVC	Cd-001	IQ08-02BPSKW2S	1055490
			NPN	Connector M8, 3-pin	Cd-002	IQ08-02BNSKT0S	1055496
				Cable, 3-wire, 2 m, PVC	Cd-001	IQ08-02BNSKW2S	1055492
		NC	PNP	Connector M8, 3-pin	Cd-004	IQ08-02BPOKT0S	1055495
				Cable, 3-wire, 2 m, PVC	Cd-003	IQ08-02BPOKW2S	1055491
			NPN	Connector M8, 3-pin	Cd-004	IQ08-02BNOKT0S	1055497
				Cable, 3-wire, 2 m, PVC	Cd-003	IQ08-02BNOKW2S	1055493

Sensing range S_n	Installation	Output function	Output type	Connection	Connection diagram	Model name	Part no.
4 mm	Non-flush	NO	PNP	Connector M8, 3-pin	Cd-002	IQ08-04NPSKT0S	1055502
				Cable, 3-wire, 2 m, PVC	Cd-001	IQ08-04NPSKW2S	1055498
			NPN	Connector M8, 3-pin	Cd-002	IQ08-04NNSKT0S	1055504
				Cable, 3-wire, 2 m, PVC	Cd-001	IQ08-04NNSKW2S	1055500
		NC	PNP	Connector M8, 3-pin	Cd-004	IQ08-04NPOKT0S	1055503
				Cable, 3-wire, 2 m, PVC	Cd-003	IQ08-04NPOKW2S	1055499
			NPN	Connector M8, 3-pin	Cd-004	IQ08-04NNOKT0S	1055505
				Cable, 3-wire, 2 m, PVC	Cd-003	IQ08-04NNOKW2S	1055501

Dimensional drawings

IQ05-xx8xx-ZU1, flush, cable

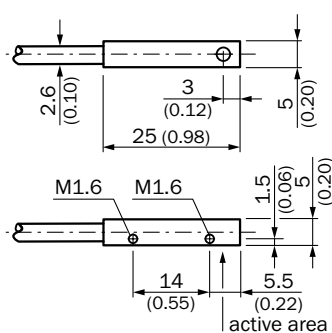

All dimensions in mm (inch)

IQ08-xxxxxxT0S, connector

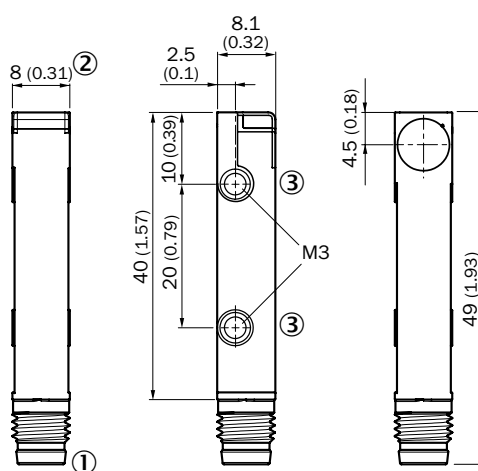

- ① Connection
- ② LED indicator 270°
- ③ Threaded mounting hole M3

C

**IQ08-xxxxxxW2S,
cable**

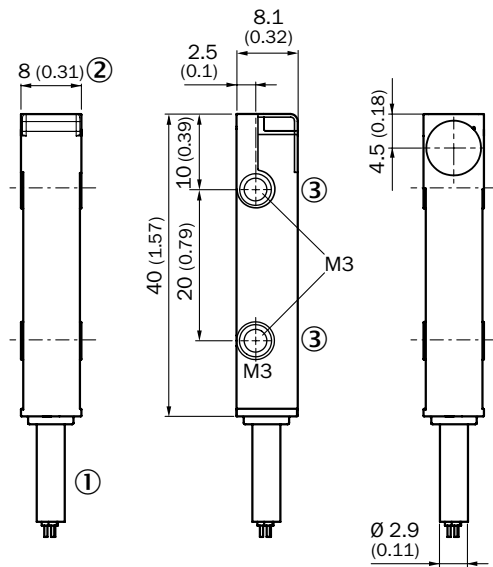

C

- ① Connection
- ② LED indicator 270°
- ③ Threaded mounting hole M3

Connection diagram

Cd-001

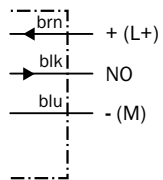

Cd-002

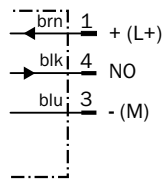

Cd-003

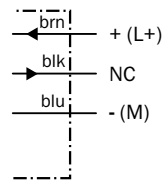

Cd-004

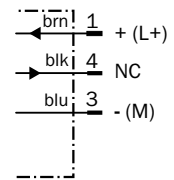

Installation note

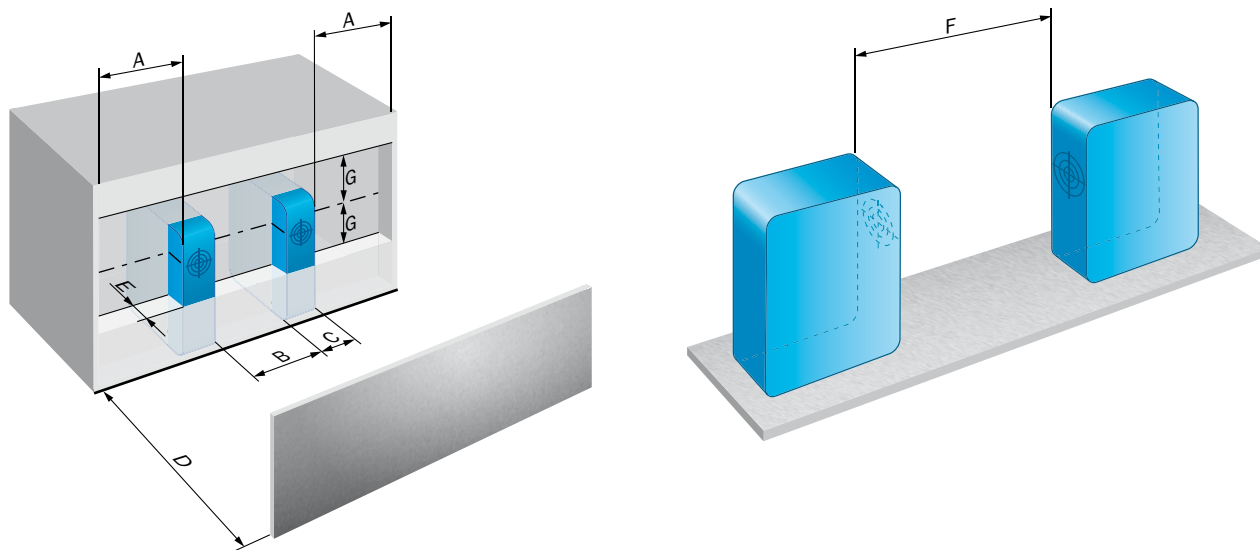

	Installation type	A	B	C	D	E	F	G
IQ05	Flush	0.8 mm	0 mm	5 mm	2.4 mm	0 mm	7 mm	3.3 mm
IQ08-02Bxxxxxx	Flush	0 mm	10 mm	8 mm	6 mm	0 mm	16 mm	0 mm
IQ08-04Nxxxxxx	Non-flush	4 mm	24 mm	8 mm	12 mm	20 mm	32 mm	8 mm

Recommended accessories

Cordsets and connectors

Connector M8, 3-pin

- Connector type: Female connector
- Enclosure rating: IP 67

Figure	Configuration	Jacket material	Cable length	Model name	Part no.
	Straight	PVC	2 m	DOL-0803-G02M	6010785
			5 m	DOL-0803-G05M	6022009
	Right angle	PVC	2 m	DOL-0803-W02M	6008489
			5 m	DOL-0803-W05M	6022010
	Straight	PBT	-	DOS-0803-G	7902077
	Right angle	PBT	-	DOS-0803-W	7902078

→ For additional accessories, please see page G-255

Low profile sensors when space is at a premium



Product description

Solve applications where space is at a premium with IQ Flat rectangular inductive sensors. Thanks to their low profile, only 4.7 mm, this family of inductive sensors is designed to fit into tight spaces. IQ Flat sensors are easily installed using one or two screws, depending on the model, which saves installation time and

costs. Greater operating distances of up to 7 mm simplify even the trickiest of detection tasks. Versions are available with a metal housing, which reduces maintenance costs. These inductive sensors are space- and cost-saving solutions for universal applications.

At a glance

- Flat, compact design
- Long sensing distance up to 7mm
- Easily visible indication LEDs
- Available in a plastic (IQ04 and IQ06) and metal housing (IQ20 and IQ25)

Your benefits

- Reduced mechanical damage due to space-saving flat housing, which does not protrude from sensor
- Time-saving simple installation with one or two screws
- No restrictions on machine design



Additional information

Detailed technical dataC-163
 Ordering informationC-164
 Dimensional drawingsC-165
 Connection diagramC-166
 Installation noteC-167

→ www.mysick.com/en/IQ_Flat

For more information, just enter the link or scan the QR code and get direct access to technical data, CAD design models, operating instructions, software, application examples and much more.



Detailed technical data

Features

	IQ 04	IQ 06	IQ 20	IQ 25
Dimensions (W x H x D) in mm	8 x 16 x 4	10 x 30 x 6	20 x 32 x 8	25 x 50 x 10
Sensing range S_n	1.5 mm	3 mm	7 mm	5 mm
Assured sensing range S_a	1.21 mm	2.43 mm	5.67 mm	4.05 mm
Installation type	Flush			
Switching frequency	600 Hz	1,000 Hz	150 Hz	500 Hz
Output type	NPN / PNP			PNP
Output function	NO / NC		NO / Complementary	
Electrical wiring	DC 3-wire		DC 3-wire / DC 4-wire	
Enclosure rating ¹⁾	IP 67			

¹⁾ According to EN60529.

Mechanical / electrical

	IQ 04	IQ 06	IQ 20	IQ 25
Supply voltage	10 V DC ... 30 V DC			
Ripple ¹⁾	≤ 10 %			≤ 15 %
Voltage drop ²⁾	< 1.5 V		< 2.5 V	≤ 2.5 V
Current consumption	10 mA ³⁾		15 mA ³⁾	≤ 32 mA ³⁾
Time delay before availability	≤ 10 ms		≤ 20 ms	≤ 50 ms
Hysteresis	1 % ... 15 %			
Repeatability ^{4) 5)}	± 1 %		± 5 %	
Temperature drift (% of S_r)	± 10 %			
EMC	According to EN 60947-5-2			
Output current I_a	100 mA		200 mA	
Connection type	Cable, 2 m, PVC	Cable, 2 m, PUR	Cable with connector, 0.3 m, PUR	Cable, 2 m, PUR,
Short-circuit protection	✓			
Reverse polarity protection	-		✓	
Shock/vibration	30 g, 11 ms/10 ... 55 Hz, 1 mm			
Ambient operating temperature	-25 °C ... +70 °C			
Housing material	Plastic, PA6-GF30		Metal, GD Zn	Metal, GD Al Si 12
Sensing face material	Plastic, PA6-GF30		Plastic, PA12	Plastic, PBT
Tightening torque, max.	0.06 Nm		-	
Reduction factor R_m	The values are reference values which may vary			
Stainless steel (V2A, 304)	0.7			
Aluminum (Al)	0.4			
Copper (Cu)	0.3			
Brass (Br)	0.4			

¹⁾ Of V_s .

²⁾ At I_a max.

³⁾ Without load.

⁴⁾ U_b and T_a constant.

⁵⁾ Of S_r .

Ordering information

IQ 04

- **Housing:** 8 mm x 16 mm x 4 mm
- **Sensing range S_n :** 1.5 mm

Output function	Output type	Electrical wiring	Connection	Connection diagram	Model name	Part no.
NO	PNP	DC 3-wire	Cable, 3-wire, 2 m, PVC	Cd-001	IQ04-1B5PSKW2S	6042017
	NPN	DC 3-wire	Cable, 3-wire, 2 m, PVC	Cd-001	IQ04-1B5NSKW2S	6042019
NC	PNP	DC 3-wire	Cable, 3-wire, 2 m, PVC	Cd-003	IQ04-1B5POKW2S	6042018
	NPN	DC 3-wire	Cable, 3-wire, 2 m, PVC	Cd-003	IQ04-1B5NOKW2S	6042020

IQ 06

- **Housing:** 10 mm x 30 mm x 6 mm
- **Sensing range S_n :** 3 mm

Output function	Output type	Electrical wiring	Connection	Connection diagram	Model name	Part no.
NO	PNP	DC 3-wire	Cable, 3-wire, 2 m, PUR	Cd-001	IQ06-03BPSKU2S	6042022
	NPN	DC 3-wire	Cable, 3-wire, 2 m, PUR	Cd-001	IQ06-03BNSKU2S	6042024
NC	PNP	DC 3-wire	Cable, 3-wire, 2 m, PUR	Cd-003	IQ06-03BP0KU2S	6042023
	NPN	DC 3-wire	Cable, 3-wire, 2 m, PUR	Cd-003	IQ06-03BN0KU2S	6042025

IQ 20

- **Housing:** 20 mm x 32 mm x 8 mm
- **Sensing range S_n :** 7 mm

Output function	Output type	Electrical wiring	Connection	Connection diagram	Model name	Part no.
NO	PNP	DC 3-wire	Cable with connector M8, 3-pin, 0.3 m, PUR	Cd-002	IQ20-07BPSDPOS	6042043
	NPN	DC 3-wire	Cable with connector M8, 3-pin, 0.3 m, PUR	Cd-002	IQ20-07BNSDPOS	6042044
Complementary	PNP	DC 4-wire	Cable with connector M8, 4-pin, 0.3 m, PUR	Cd-006	IQ20-07BPPDQ0S	6042045

IQ 25

- **Housing:** 25 mm x 50 mm x 10 mm
- **Sensing range S_n :** 5 mm

Output function	Output type	Electrical wiring	Connection	Connection diagram	Model name	Part no.
NO	PNP	DC 3-wire	Cable, 3-wire, 2 m, PUR	Cd-001	IQ25-05BPSDU2S	6042046
Complementary	PNP	DC 4-wire	Cable, 4-wire, 2 m, PUR	Cd-005	IQ25-05BPPDU2S	6042047

Dimensional drawings

IQ04

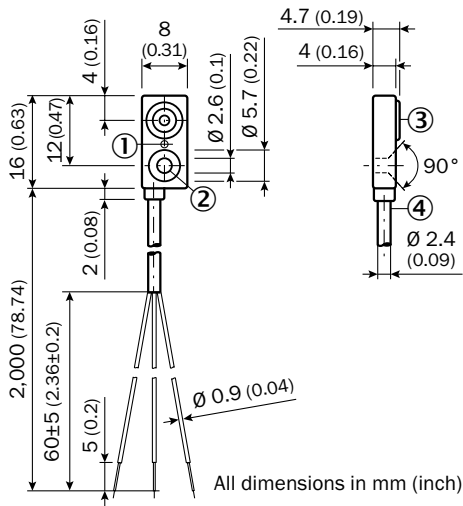

- ① Function indicator (red)
- ② Mounting hole
- ③ Sensing area
- ④ Connection

IQ06

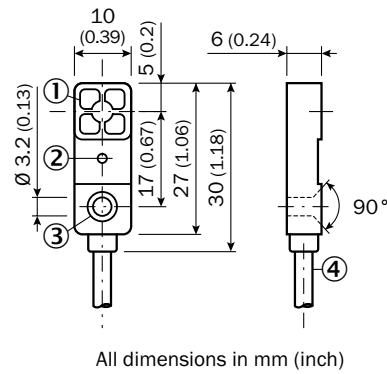

- ① Sensing area
- ② Function indicator (red)
- ③ Mounting hole
- ④ Connection

**IQ20-xxxxxPxx,
cable with connector M8**

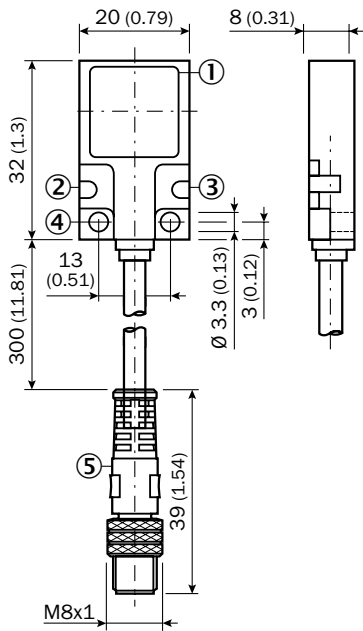

All dimensions in mm (inch)

- ① Sensing area
- ② Operation status LED, green
- ③ Status LED, yellow
- ④ Mounting hole
- ⑤ Connection

**IQ20-xxxxxQxx,
cable with connector M12**

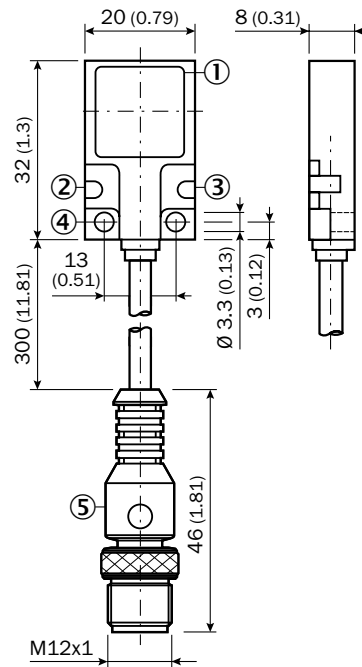

All dimensions in mm (inch)

- ① Sensing area
- ② Operation status LED, green
- ③ Status LED, yellow
- ④ Mounting hole
- ⑤ Connection



IQ25

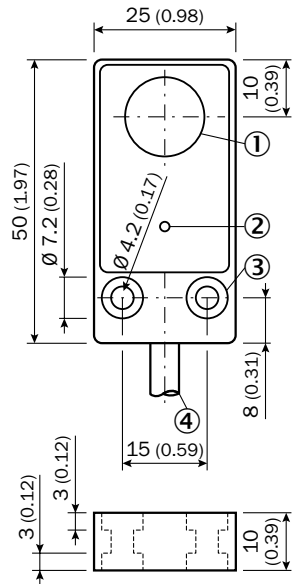

All dimensions in mm (inch)

- ① Sensing area
- ② Function signal indicator (green)
- ③ Mounting hole
- ④ Connection

Connection diagram

Cd-001

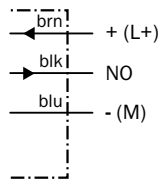

Cd-002

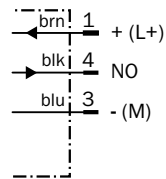

Cd-003

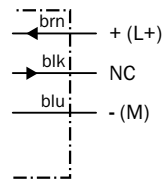

Cd-005

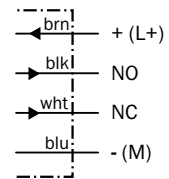

Cd-006

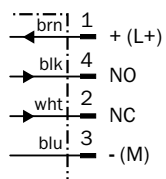

Installation note

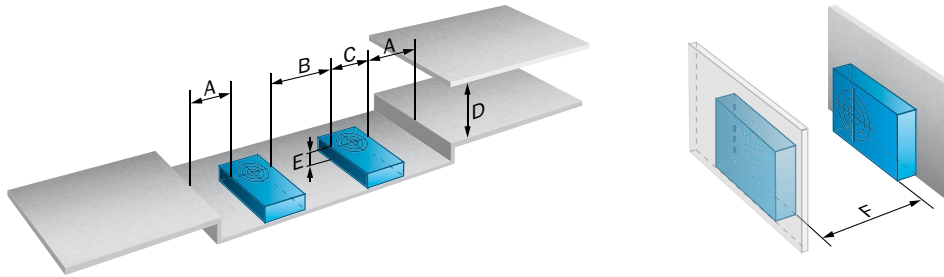

	A	B	C	D	E	F
IQ04	0 mm	16 mm	8 mm	4.5 mm	0 mm	24 mm
IQ06	1.5 mm	20 mm	10 mm	9 mm	0 mm	30 mm
IQ20	0 mm	20 mm	20 mm	21 mm	0 mm	60 mm
IQ25	0 mm	25 mm	25 mm	15 mm	0 mm	75 mm

C

An all around solution for many applications

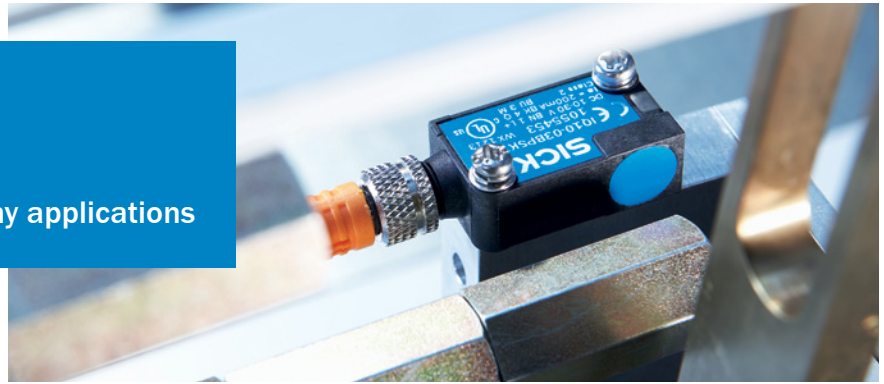

Product description

The compact IQ10 provides great performance. Thanks to SICK-ASIC technology, the impressive IQ10 rectangular sensor family offers sensing ranges of up to 6 mm, outperforming many larger sensors. Thanks to its small size, simple mounting

and highly visible 270° status display, it is ideal for applications where space is at a premium. With tough VISTAL™ housing, innovative hotmelt molding and an enclosure rating of IP 68, it is also ideal for more demanding applications.

At a glance

- Tough VISTAL™ housing
- SICK-ASIC technology
- 270° status display with extra-bright LED
- Extended sensing range of up to 6 mm
- Hotmelt molding
- Withstands high installation and tightening torque
- IP 68 enclosure rating

Your benefits

- Best mechanical and electronic stability for extra-long service life
- Highest levels of process reliability for your application
- Long service life that reduce maintenance costs thanks to SICK's ASIC technology and rugged VISTAL™ housing
- Precise detection and high sensor accuracy enable fast handling and assembly processes
- Space-saving integration in every application
- Increased levels of protection against shock and vibration reduce maintenance costs
- Quick viewing of sensor status from any position in the room reduces mounting time and commissioning
- Safe, fast mounting without any need for readjustment saves installation time and maintenance costs



Additional information

Detailed technical data	C-169
Ordering information	C-170
Dimensional drawings	C-171
Connection diagram	C-171
Installation note	C-172
Recommended accessories	C-172

→ www.mysick.com/en/IQ10

For more information, just enter the link or scan the QR code and get direct access to technical data, CAD design models, operating instructions, software, application examples and much more.



Detailed technical data

Features

	DC 3-wire	DC 4-wire
Dimensions (W x H x D) in mm	10 x 16 x 28	
Sensing range S_n	Flush	3 mm
	Non-flush	6 mm
Assured sensing range S_a	Flush	2.43 mm
	Non-flush	4.86 mm
Installation type	Flush / Non-flush	Flush
Switching frequency	2,000 Hz	
Output type	PNP / NPN	
Output function	NO / NC	Complementary
Electrical wiring	DC 3-wire	DC 4-wire
Enclosure rating ¹⁾	IP 67, IP 68	

¹⁾ According to EN60529.

Mechanical / electrical

	DC 3-wire	DC 4-wire
Supply voltage	10 V DC ... 30 V DC	
Ripple ^{1) 1)}	≤ 10 %	
Voltage drop ²⁾	≤ 2 V	
Current consumption ³⁾	≤ 10 mA	
Time delay before availability	≤ 100 ms	
Hysteresis	5 % ... 15 %	
Repeatability	≤ 2 % ^{4) 5)}	≤ 2 % ^{4) 5)}
Temperature drift (% of S_r)	± 10 %	
EMC	According to EN 60947-5-2	
Output current I_a	≤ 200 mA	
Connection type	Connector, M8 / Cable, 2 m, PVC	Cable, 2 m, PVC
Short-circuit protection	✓	
Reverse polarity protection	✓	
Power-up pulse protection	✓	
Shock/vibration	30 g, 11 ms/10 ... 55 Hz, 1 mm	
Ambient operating temperature	-25 °C ... +75 °C	
Housing material	Plastic, VISTAL™	
Sensing face material	Plastic, VISTAL™	
Tightening torque, max.	≤ 2 Nm	

	DC 3-wire	DC 4-wire
Reduction factor R_m	The values are reference values which may vary	
Stainless steel (V2A, 304)	0.75	
Aluminum (Al)	Flush	0.4
	Non-flush	0.5
Copper (Cu)	0.35	
Brass (Br)	0.5	

¹⁾ Of V_S .

²⁾ At I_a max.

³⁾ Without load.

⁴⁾ U_b and T_a constant.

⁵⁾ Of S_r .

⁶⁾ $U_b = 20 \dots 30$ VDC, $T_a = 23 \text{ °C} \pm 5 \text{ °C}$.

C

Ordering information

DC 3-wire

Sensing range S_n	Installation	Output function	Output type	Connection	Connection diagram	Model name	Part no.	
3 mm	Flush	NO	PNP	Connector M8, 3-pin	Cd-002	IQ10-03BPSKT0S	1055453	
				Cable, 3-wire, 2 m, PVC	Cd-001	IQ10-03BPSKW2S	1055447	
		NPN	PNP	Connector M8, 3-pin	Cd-002	IQ10-03BNSKT0S	1055455	
				Cable, 3-wire, 2 m, PVC	Cd-002	IQ10-03BNSKW2S	1055450	
		NC	PNP	NPN	Connector M8, 3-pin	Cd-004	IQ10-03BPOKT0S	1055454
					Cable, 3-wire, 2 m, PVC	Cd-003	IQ10-03BPOKW2S	1055449
NPN	PNP	NPN	Connector M8, 3-pin	Cd-004	IQ10-03BNOKT0S	1055456		
			Cable, 3-wire, 2 m, PVC	Cd-003	IQ10-03BNOKW2S	1055452		
6 mm	Non-flush	NO	PNP	Connector M8, 3-pin	Cd-002	IQ10-06NPSKT0S	1055461	
				Cable, 3-wire, 2 m, PVC	Cd-001	IQ10-06NPSKW2S	1055457	
		NPN	PNP	NPN	Connector M8, 3-pin	Cd-002	IQ10-06NNSKT0S	1055463
					Cable, 3-wire, 2 m, PVC	Cd-001	IQ10-06NNSKW2S	1055459
		NC	PNP	NPN	Connector M8, 3-pin	Cd-004	IQ10-06NPOKT0S	1055462
					Cable, 3-wire, 2 m, PVC	Cd-003	IQ10-06NPOKW2S	1055458
NPN	PNP	NPN	Connector M8, 3-pin	Cd-004	IQ10-06NNOKT0S	1055464		
			Cable, 3-wire, 2 m, PVC	Cd-003	IQ10-06NNOKW2S	1055460		

DC 4-wire

Sensing range S_n	Installation	Output function	Output type	Connection	Connection diagram	Model name	Part no.
3 mm	Flush	Complementary	PNP	Cable, 4-wire, 2 m, PVC	Cd-005	IQ10-03BPPKW2S	1055465
			NPN	Cable, 4-wire, 2 m, PVC	Cd-005	IQ10-03BNPKW2S	1055466

Dimensional drawings

**IQ10-xxxxxT0S,
connector**

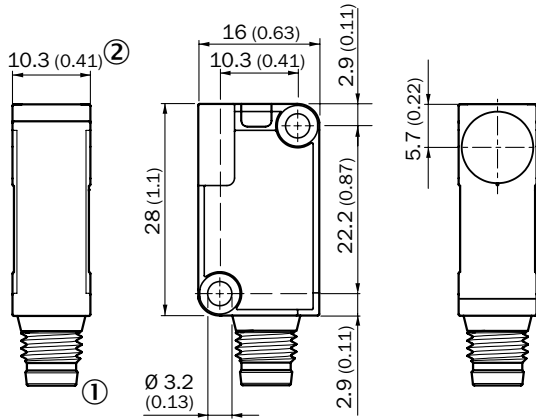

- ① Connection
- ② LED indicator 270°
- ③ Threaded mounting hole M3

**IQ10-xxxxxW2S
cable**

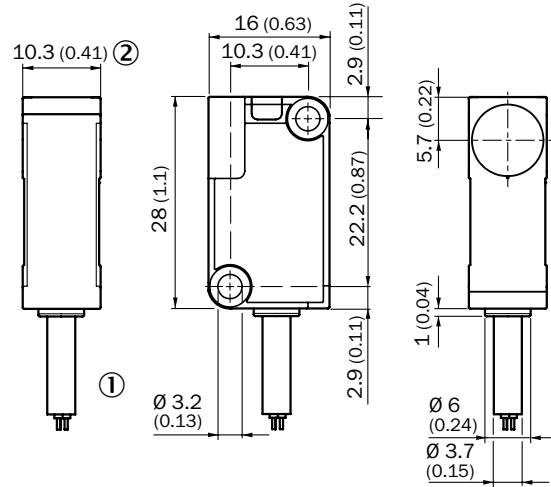

- ① Connection
- ② LED indicator 270°
- ③ Threaded mounting hole M3

dimensions in mm (inch)

Connection diagram

Cd-001

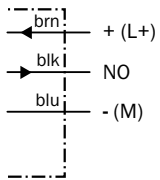

Cd-002

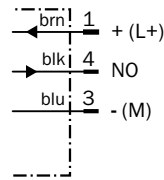

Cd-003

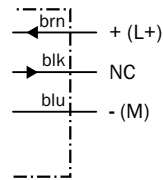

Cd-004

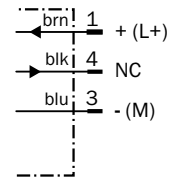

Cd-005

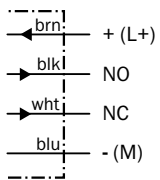

Installation note

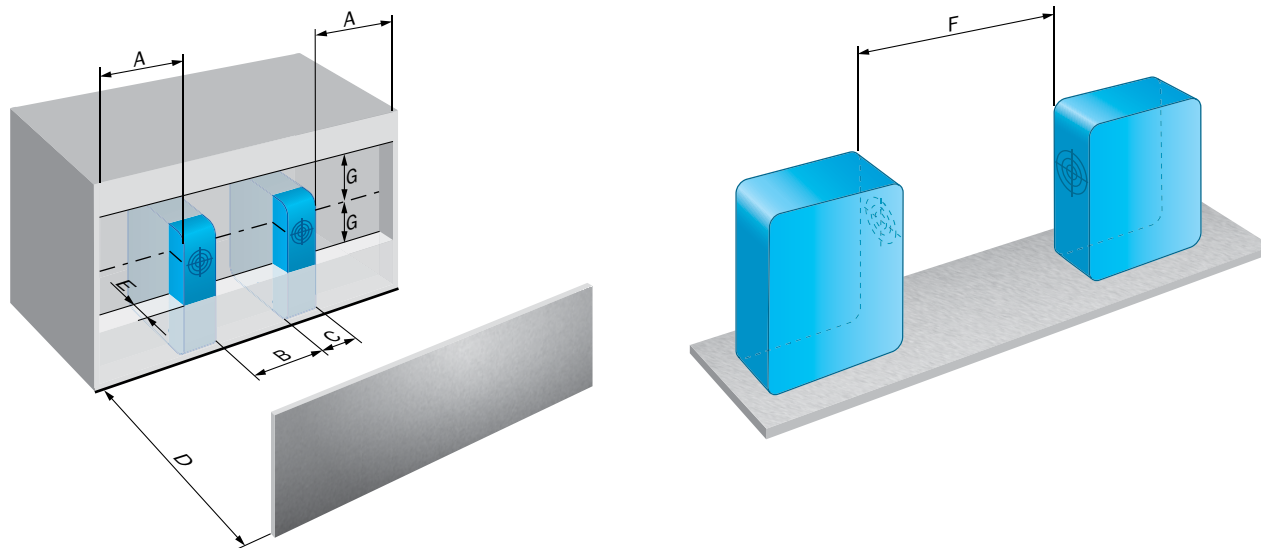

C

	Installation type	A	B	C	D	E	F	G
IQ10-03Bxxxxx	Flush	0 mm	10 mm	10.3 mm	9 mm	0 mm	24 mm	0 mm
IQ10-06Nxxxxx	Non-flush	7 mm	30 mm	10.3 mm	18 mm	12 mm	48 mm	12 mm

Recommended accessories

Cordsets and connectors

Connector M8, 3-pin

- Connector type: Female connector
- Enclosure rating: IP 67

Figure	Configuration	Jacket material	Cable length	Model name	Part no.
	Straight	PVC	2 m	DOL-0803-G02M	6010785
			5 m	DOL-0803-G05M	6022009
	Right angle	PVC	2 m	DOL-0803-W02M	6008489
			5 m	DOL-0803-W05M	6022010
	Straight	PBT	-	DOS-0803-G	7902077
	Right angle	PBT	-	DOS-0803-W	7902078

→ For additional accessories, please see page G-255

C

Economic, best-in-class performance



Additional information

Detailed technical data.....	C-175
Ordering information.....	C-176
Dimensional drawings.....	C-177
Connection diagram.....	C-177
Installation note.....	C-178
Recommended accessories.....	C-178

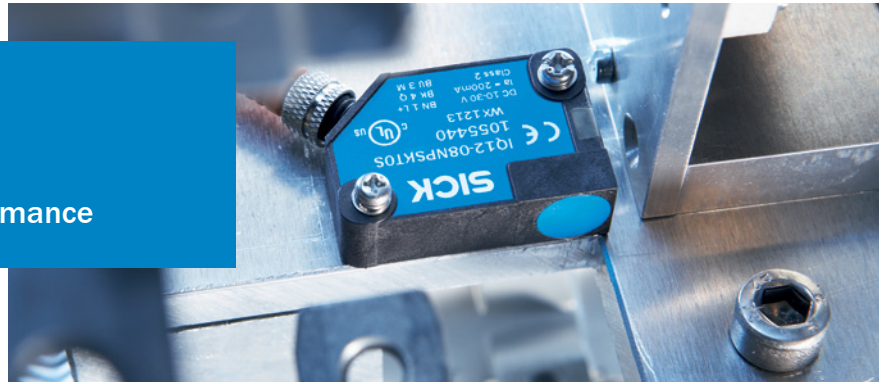

Product description

With a compact design and best-in-class performance, the rectangular IQ12 sensor family offers extended sensing ranges of up to 8 mm and state-of-the-art SICK-ASIC technology. Its proven, reliable design with 270° status display is also ideal for more demanding applica-

tions. Extremely rugged VISTAL™ housing, innovative hotmelt molding and an IP 68 enclosure rating of make the IQ12 family the first choice for a wide range of applications and ensures the highest possible levels of process reliability and satisfaction.

At a glance

- Tough VISTAL™ housing
- SICK-ASIC technology
- 270° status display with extra-bright LED
- Extended sensing range of up to 8 mm
- Hotmelt molding
- Withstands high installation and tightening torque
- IP 68 enclosure rating

Your benefits

- Best mechanical and electronic stability for extra-long service life
- Highest levels of process reliability for your application
- Long service life that reduce maintenance costs thanks to SICK's ASIC technology and rugged VISTAL™ housing
- Precise detection and high sensor accuracy enable fast handling and assembly processes
- Space-saving integration in every application
- Increased levels of protection against shock and vibration reduce maintenance costs
- Quick viewing of sensor status from any position in the room reduces mounting time and commissioning
- Safe, fast mounting without any need for readjustment saves installation time and maintenance costs

→ www.mysick.com/en/IQ12

For more information, just enter the link or scan the QR code and get direct access to technical data, CAD design models, operating instructions, software, application examples and much more.



Detailed technical data

Features

Dimensions (W x H x D) in mm	12 x 26 x 40	
Sensing range S_n	Flush	4 mm
	Non-flush	8 mm
Assured sensing range S_a	Flush	3.24 mm
	Non-flush	6.48 mm
Installation type	Flush / Non-flush	
Switching frequency	2,000 Hz	
Output type	PNP / NPN	
Output function	NO / NC / Complementary	
Electrical wiring	DC 3-wire / DC 4-wire	
Enclosure rating ¹⁾	IP 67, IP 68	

¹⁾ According to EN60529.

C

Mechanical / electrical

Supply voltage	10 V DC ... 30 V DC
Ripple ^{1) 1)}	≤ 10 %
Voltage drop ²⁾	≤ 2 V
Current consumption ³⁾	≤ 10 mA
Time delay before availability	≤ 100 ms
Hysteresis	5 % ... 15 %
Repeatability	≤ 2 % ^{4) 5) 6)}
Temperature drift (% of S_r)	± 10 %
EMC	According to EN 60947-5-2
Output current I_a	≤ 200 mA
Connection type	Connector, M8 / Cable, 2 m, PVC
Short-circuit protection	✓
Reverse polarity protection	✓
Power-up pulse protection	✓
Shock/vibration	30 g, 11 ms/10 ... 55 Hz, 1 mm
Ambient operating temperature	-25 °C ... +75 °C
Housing material	Plastic, VISTAL™
Sensing face material	Plastic, VISTAL™
Tightening torque, max.	≤ 2 Nm

Reduction factor RM	The values are reference values which may vary	
Stainless steel (V2A, 304)	0.7	
Aluminum (Al)	Flush	0.4
	Non-flush	0.5
Copper (Cu)	Flush	0.3
	Non-flush	0.4
Brass (Br)	Flush	0.4
	Non-flush	0.5

¹⁾ Of V_s .

²⁾ At I_a max.

³⁾ Without load.

⁴⁾ U_b and T_a constant.

⁵⁾ Of S_r .

⁶⁾ $U_b = 20 \dots 30$ VDC, $T_a = 23 \text{ °C} \pm 5 \text{ °C}$.

C

Ordering information

DC 3-wire

Sensing range S_n	Installation	Output function	Output type	Connection	Connection diagram	Model name	Part no.	
4 mm	Flush	NO	PNP	Connector M8, 3-pin	Cd-002	IQ12-04BPSKT0S	1055432	
				Cable, 3-wire, 2 m, PVC	Cd-001	IQ12-04BPSKW2S	1055428	
		NPN	PNP	Connector M8, 3-pin	Cd-002	IQ12-04BNSKT0S	1055434	
				Cable, 3-wire, 2 m, PVC	Cd-001	IQ12-04BNSKW2S	1055430	
		NC	PNP	NPN	Connector M8, 3-pin	Cd-004	IQ12-04BPOKT0S	1055433
					Cable, 3-wire, 2 m, PVC	Cd-003	IQ12-04BPOKW2S	1055429
NC	NPN	PNP	Connector M8, 3-pin	Cd-004	IQ12-04BNOKT0S	1055435		
			Cable, 3-wire, 2 m, PVC	Cd-003	IQ12-04BNOKW2S	1055431		
8 mm	Non-flush	NO	PNP	Connector M8, 3-pin	Cd-002	IQ12-08NPSKT0S	1055440	
				Cable, 3-wire, 2 m, PVC	Cd-001	IQ12-08NPSKW2S	1055436	
		NPN	PNP	Connector M8, 3-pin	Cd-002	IQ12-08NNSKT0S	1055442	
				Cable, 3-wire, 2 m, PVC	Cd-001	IQ12-08NNSKW2S	1055438	
		NC	PNP	NPN	Connector M8, 3-pin	Cd-004	IQ12-08NPOKT0S	1055441
					Cable, 3-wire, 2 m, PVC	Cd-003	IQ12-08NPOKW2S	1055437
NC	NPN	PNP	Connector M8, 3-pin	Cd-004	IQ12-08NNOKT0S	1055443		
			Cable, 3-wire, 2 m, PVC	Cd-003	IQ12-08NNOKW2S	1055439		

DC 4-wire

Sensing range S_n	Installation	Output function	Output type	Connection	Connection diagram	Model name	Part no.
4 mm	Flush	Complementary	PNP	Cable, 4-wire, 2 m, PVC	Cd-005	IQ12-04BPPKW2S	1055444
			NPN	Cable, 4-wire, 2 m, PVC	Cd-005	IQ12-04BNPKW2S	1055445

Dimensional drawings

**IQ12-xxxxxT0S,
connector**

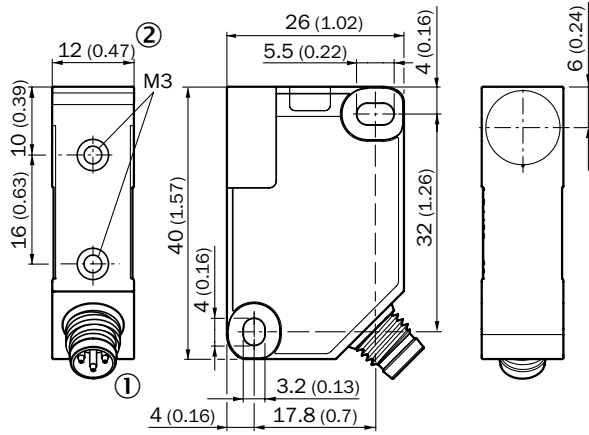

- ① Connection
- ② LED indicator 270°
- ③ Threaded mounting hole M3

**IQ12-xxxxxW2S,
cable**

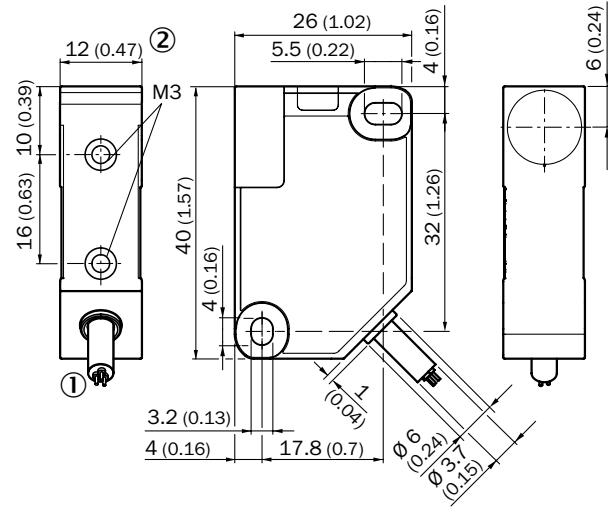

- ① Connection
- ② LED indicator 270°
- ③ Threaded mounting hole M3

dimensions in mm (inch)

Connection diagram

Cd-001

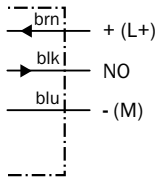

Cd-002

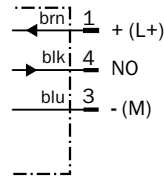

Cd-003

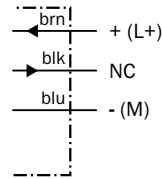

Cd-004

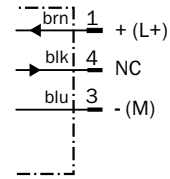

Cd-005

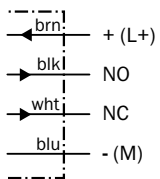

Installation note

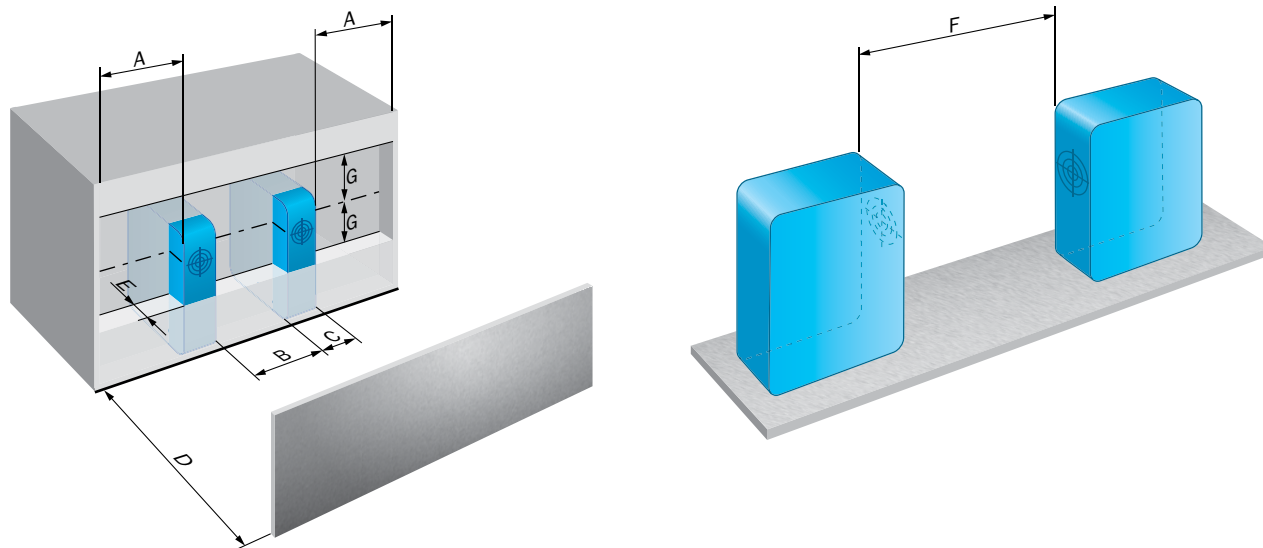

C

	Installation type	A	B	C	D	E	F	G
IQ12-04Bxxxxxx	Flush	0 mm	12 mm	12 mm	12 mm	0 mm	32 mm	0 mm
IQ12-08Nxxxxxx	Non-flush	10 mm	36 mm	12 mm	24 mm	16 mm	64 mm	16 mm

Recommended accessories

Cordsets and connectors

Connector M8, 3-pin

- Connector type: Female connector
- Enclosure rating: IP 67

Figure	Configuration	Jacket material	Cable length	Model name	Part no.
	Straight	PVC	2 m	DOL-0803-G02M	6010785
			5 m	DOL-0803-G05M	6022009
	Right angle	PVC	2 m	DOL-0803-W02M	6008489
			5 m	DOL-0803-W05M	6022010
	Straight	PBT	-	DOS-0803-G	7902077
	Right angle	PBT	-	DOS-0803-W	7902078

→ For additional accessories, please see page G-255

C

Tried and trusted housing style
in 40 x 40mm dimension



C



Product description

The reliable IQ40 rectangular inductive proximity sensor has proven its reliability in countless applications over many years, not only in handling and warehousing systems, but also in many other industries. Versatile installation and setting options, highly reliable design and

long operating distances are just a few of the features behind the success of the IQ40 family. Corner LEDs, easily visible from a number of angles, clearly display the output and operational state - even under difficult installation conditions.

At a glance

- Increased operating distance up to 40 mm
- Corner LEDs
- Sensing face rotatable in five directions
- Sturdy and compact design
- Integrated mounting clamp

Your benefits

- Flexible mounting options due to rotatable sensor head
- Time-saving monitoring with highly visible power and output LEDs.
- Cost reduction due to reduced mechanical damage with increased sensing distance
- Shorter installation times due to integrated mounting fixture
- Reduced maintenance costs



Additional information

Detailed technical dataC-181
 Ordering informationC-182
 Dimensional drawingsC-182
 Connection diagramC-182
 Installation noteC-183
 Recommended accessoriesC-183

→ www.mysick.com/en/IQ40
 For more information, just enter the link or scan the QR code and get direct access to technical data, CAD design models, operating instructions, software, application examples and much more.



Detailed technical data

Features

	DC 3-wire	DC 4-wire
Dimensions (W x H x D) in mm	40 x 40 x 66	
Sensing range S_n	Flush	20 mm
	Non-flush	40 mm
Assured sensing range S_a	Flush	16.2 mm
	Non-flush	32.4 mm
Installation type	Flush / Non-flush	
Switching frequency	Flush	100 Hz
	Non-flush	60 Hz
Output type	PNP	
Output function	NO	Complementary
Electrical wiring	DC 3-wire	DC 4-wire
Enclosure rating ¹⁾	IP 67	

¹⁾ According to EN60529.

Mechanical / electrical

	DC 3-wire	DC 4-wire
Supply voltage	10 V DC ... 36 V DC	
Voltage drop ¹⁾	≤ 2.5 V	
Current consumption ²⁾	≤ 20 mA	≤ 25 mA
Hysteresis	1 % ... 20 %	
Temperature drift (% of S_p)	± 10 %	
EMC	According to EN 60947-5-2	
Output current I_a	≤ 200 mA	
Connection type	Connector M12, 4-pin	
Short-circuit protection	✓	
Reverse polarity protection	✓	
Power-up pulse protection	✓	
Shock/vibration	30 g, 11 ms/10 ... 55 Hz, 1 mm	
Ambient operating temperature	-25 °C ... +70 °C	
Housing material	Plastic	
Sensing face material	Plastic, PA6	
Special features	Class 2 power source, as per cULus	
Reduction factor R_m	The values are reference values which may vary	
	Stainless steel (V2A, 304)	0.7
	Aluminum (Al)	0.4
	Copper (Cu)	0.3
	Brass (Br)	0.4

¹⁾ With I_a max and U_b 24 V.

²⁾ Without load.

Ordering information

DC 3-wire

Sensing range S_n	Installation	Switching frequency	Output function	Output type	Connection	Connection diagram	Model name	Part no.
20 mm	Flush	100 Hz	NO	PNP	Connector M12, 4-pin	Cd-011	IQ40-20BPSKC0K	6037070
40 mm	Non-flush	60 Hz	NO	PNP	Connector M12, 4-pin	Cd-011	IQ40-40NPSKC0K	6037071

DC 4-wire

Sensing range S_n	Installation	Switching frequency	Output function	Output type	Connection	Connection diagram	Model name	Part no.
20 mm	Flush	100 Hz	Complementary	PNP	Connector M12, 4-pin	Cd-010	IQ40-20BPPKC0K	6037072
40 mm	Non-flush	60 Hz	Complementary	PNP	Connector M12, 4-pin	Cd-010	IQ40-40NPPKC0K	6037073

C

Dimensional drawings

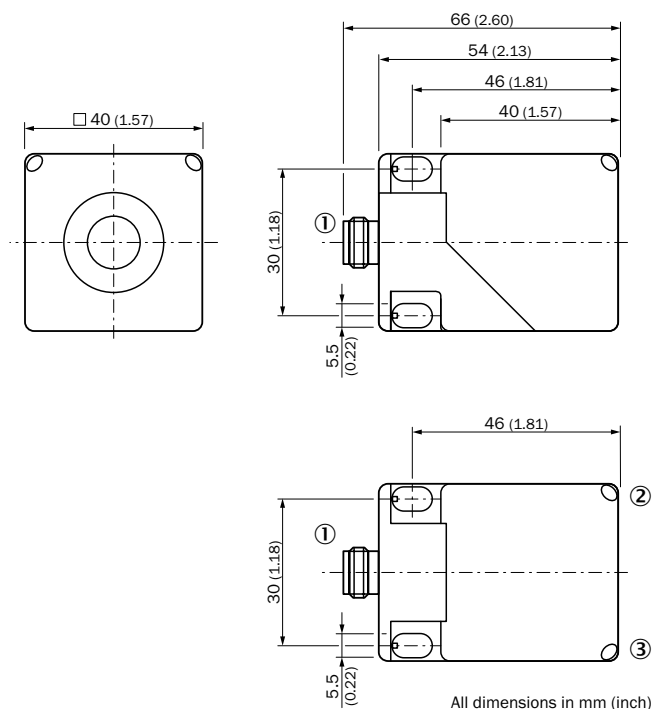

- ① M12 connector, 4-pin
- ② Status LED, yellow
- ③ Operation status LED, green

dimensions in mm

Connection diagram

Cd-010

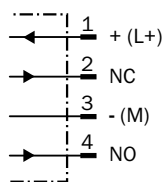

Cd-011

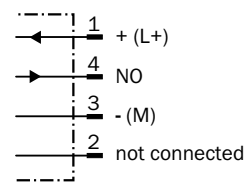

Installation note

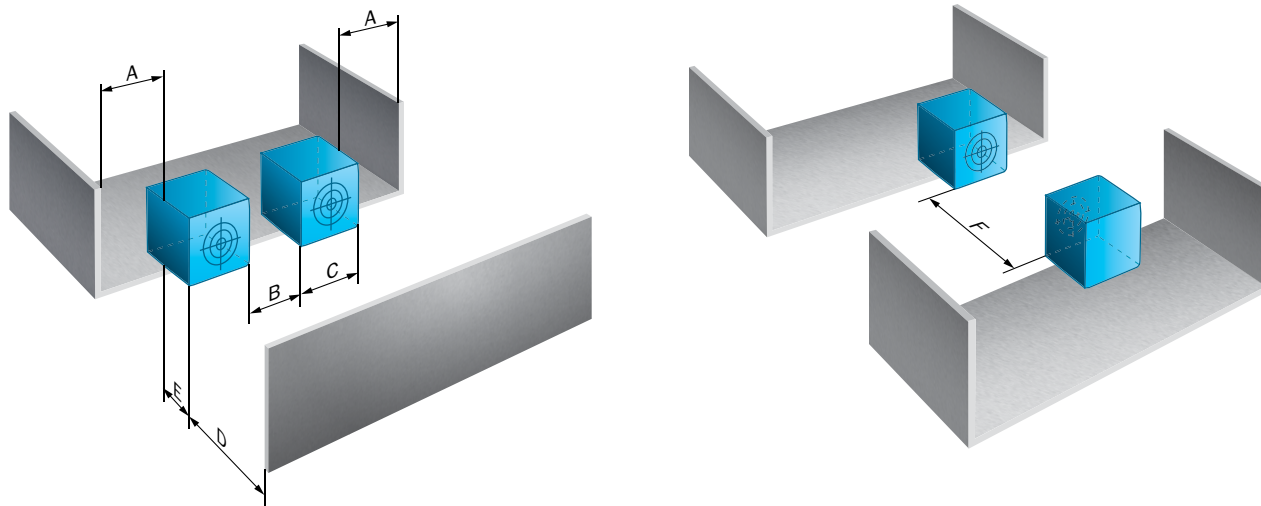

	Installation type	A	B	C	D	E	F
IQ40-20Bxx-xxx	Flush	0 mm	40 mm	40 mm	60 mm	0 mm	160 mm
IQ40-40Nxx-xxx	Non-flush	80 mm	100 mm	40 mm	120 mm	40 mm	320 mm

Recommended accessories

Cordsets and connectors

Connector M12, 4-pin

Figure	Connector type	Enclosure rating	Configuration	Jacket material	Cable length	Model name	Part no.
	Female connector	IP 67	Straight	PVC	2 m	DOL-1204-G02M	6009382
					5 m	DOL-1204-G05M	6009866
					10 m	DOL-1204-G10M	6010543
	Female connector	IP 68	Right angle	PVC	2 m	DOL-1204-L02M	6027945
					5 m	DOL-1204-L05M	6027944
	Female connector	IP 67	Right angle	PVC	2 m	DOL-1204-W02M	6009383
					5 m	DOL-1204-W05M	6009867
	Male connector	IP 67	Straight	PBT	-	STE-1204-G	6009932
			Right angle	PBT	-	STE-1204-W	6022084

→ For additional accessories, please see page G-255

Tried and trusted housing style in 40 x 40mm dimension

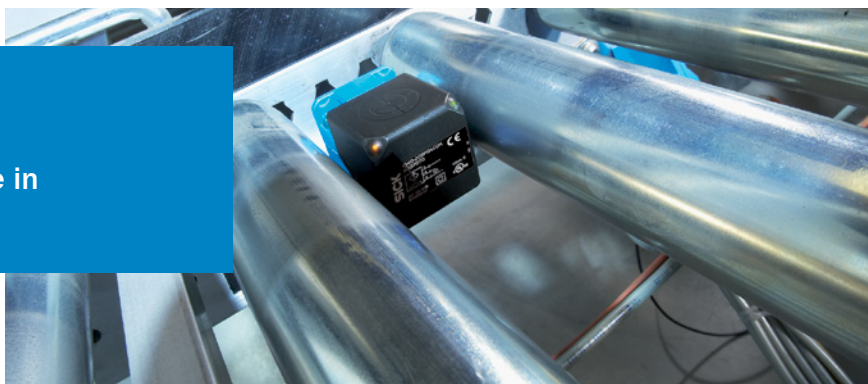

C

Product description

The reliable IQ40 rectangular inductive proximity sensor has proven its reliability in countless applications over many years, not only in handling and warehousing systems, but also in many other

industries. Versatile installation and setting options, highly reliable design and long operating distances are just a few of the features behind the success of the IQ40 family.

At a glance

- Corner LEDs
- Sensing face rotatable in five directions
- Sturdy and compact design
- Integrated mounting clamp
- DC and AC/DC versions available

Your benefits

- Flexible mounting options due to rotatable sensor head
- Time-saving monitoring with highly visible power and output LEDs.
- Cost reduction due to reduced mechanical damage with increased sensing distance
- Shorter installation times due to integrated mounting fixture
- Reduced maintenance costs



Additional information

Detailed technical dataC-185

Ordering informationC-186

Dimensional drawingsC-187

Connection diagramC-188

Installation noteC-189

→ www.mysick.com/en/IQ40

For more information, just enter the link or scan the QR code and get direct access to technical data, CAD design models, operating instructions, software, application examples and much more.



Detailed technical data

Features

	DC 4-wire	DC 3-wire	AC/DC 2-wire	DC 2-wire	AC 2-wire
Dimensions (W x H x D) in mm	40 x 40 x 118	40 x 40 x 121		40 x 40 x 118	
Sensing range S_n	Flush	15 mm			
	Non-flush	20 mm		-	
Assured sensing range S_a	Flush	12.15 mm			
	Non-flush	16.2 mm		-	
Installation type	Flush / non-flush (depending on type)			Flush	
Switching frequency	150 Hz	300 Hz	20 Hz ¹⁾ / 55 Hz ²⁾	400 Hz	20 Hz
Output type	PNP		-		
Output function	Complementary	NC or NO, wire configurable			
Electrical wiring	DC 4-wire	DC 3-wire	AC/DC 2-wire	DC 2-wire	AC 2-wire
Enclosure rating ³⁾	IP 68	IP 65		IP 68	

¹⁾ AC.

²⁾ DC.

³⁾ According to EN60529.

C

Mechanical / electrical

	DC 4-wire	DC 3-wire	AC/DC 2-wire	DC 2-wire	AC 2-wire
Supply voltage	10 V DC ... 60 V DC	10 V DC ... 36 V DC	20 V AC/DC ... 250 V AC/DC	5 V DC ... 60 V DC	20 V AC ... 253 V AC ¹⁾
Hysteresis	-	1 % ... 15 %		-	
Temperature drift (% of S_r)	± 10 %				
EMC	According to EN 60947-5-2		According to EN 60947-5-2, As per EN 55011 class B	According to EN 60947-5-2	
Short-time withstand current	-		2.2 A ²⁾	-	3 A ³⁾
Connection type	Cable gland				
Terminal thread size	M20 x 1.5				
Short-circuit protection	✓		- ⁵⁾	✓	
Reverse polarity protection	✓		- ⁶⁾	✓	
Power-up pulse protection	-				✓
Shock/vibration	30 g, 11 ms/10 ... 55 Hz, 1 mm				
Ambient operating temperature	-25 °C ... +70 °C	-25 °C ... +80 °C		-25 °C ... +70 °C	
Housing material	Plastic, PBT	Plastic, PPE		Plastic, PBT	
Sensing face material	Plastic, PBT	Plastic, PPE		Plastic, PBT	

	DC 4-wire	DC 3-wire	AC/DC 2-wire	DC 2-wire	AC 2-wire
Reduction factor R_M	The values are reference values which may vary				
Stainless steel (V2A, 304)					
Flush	0.75	0.7		0.75	
Non-flush	0.8	0.7		–	
Aluminum (Al)					
Flush	0.3			0.28	0.3
Non-flush	0.35	0.3		–	
Copper (Cu)					
Flush	0.25	0.2		0.25	
Non-flush	0.35	0.2		–	
Brass (Br)					
Flush	–	0.4		–	
Non-flush	–	0.4		–	

¹⁾ At temperatures below 0 °C supply voltage 80...253 V.

²⁾ 20 ms/ 0.5 Hz.

³⁾ 20 ms/ 0.1 Hz.

⁴⁾ Miniature fuse as per IEC 60217-2 Sheet 1, ≤ 2 A (quick-blow)

Ordering information

DC 4-wire

- Output current I_a : ≤ 200 mA

Sensing range	Installation	Output function	Output type	Connection	Connection diagram	Model name	Part no.
15 mm	Flush	Complementary	PNP	Terminal connection with M20 gland	Cd-030	IQ40-15BPP-KK1	6025814
20 mm	Non-flush					IQ40-20NPP-KK1	6025815

DC 3-wire

- Output current I_a : ≤ 250 mA

Sensing range	Installation	Output function	Output type	Connection	Connection diagram	Model name	Part no.
15 mm	Flush	NC or NO	PNP	Terminal connection with M20 gland	Cd-019	IQ40-15BPP-KK0	7900219
20 mm	Non-flush					IQ40-20NPP-KK0	7900221

AC/DC 2-wire

- Output current I_a : ≤ 350 mA, AC (+50 °C) / ≤ 250 mA, AC (+80 °C) / ≤ 100 mA, DC
- Off-state current: ≤ 2.5 mA (AC 250 V) / ≤ 1.3 mA (AC 110V) / ≤ 0.8 mA (DC 24 V)

Sensing range	Installation	Output function	Connection	Connection diagram	Model name	Part no.
15 mm	Flush	NC or NO	Terminal connection with M20 gland	Cd-018	IQ40-15BUP-KK0	7902136
20 mm	Non-flush				IQ40-20NUP-KK0	7902137

DC 2-wire

- Output current I_a : ≤ 200 mA
- Off-state current: ≤ 1 mA

Sensing range	Installation	Output function	Connection	Connection diagram	Model name	Part no.
15 mm	Flush	NC or NO	Terminal connection with M20 gland	Cd-016	IQ40-15BDP-KK1	6025817

AC 2-wire

- Output current I_a : ≤ 200 mA
- Off-state current: ≤ 1.95 mA

Sensing range	Installation	Output function	Connection	Connection diagram	Model name	Part no.
15 mm	Flush	NC or NO	Terminal connection with M20 gland	Cd-017	IQ40-15BAP-KK1	6025816

Dimensional drawings

IQ40-xxxx-KK1,
DC 4-wire, DC 2-wire, AC 2-wire

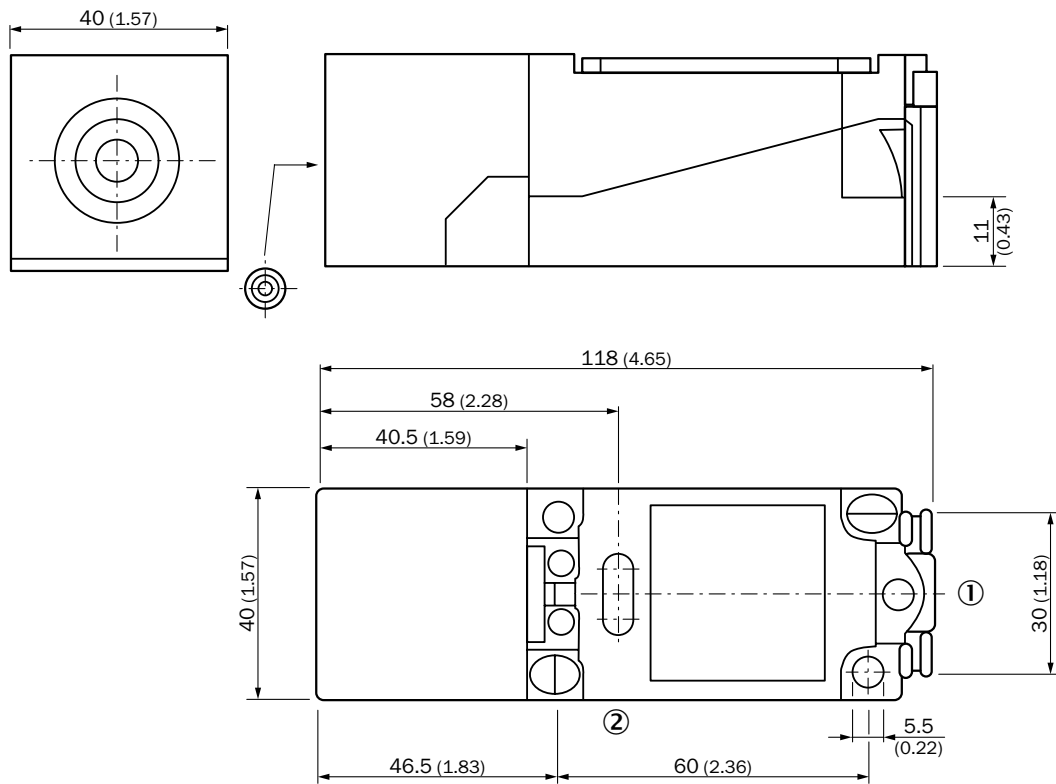

All dimensions in mm (inch)

- ① Connection
- ② LED indicator

C

**IQ40-xxxx-KK0,
DC 3-wire, AC/DC 2-wire**

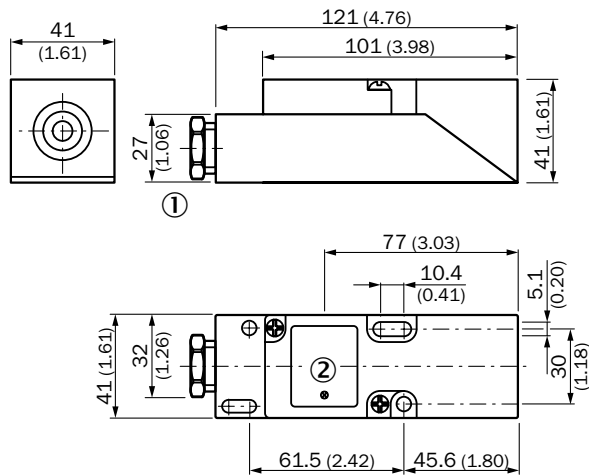

C

All dimensions in mm (inch)

- ① Connection
- ② LED indicator

Connection diagram

Cd-016

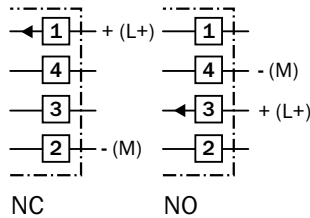

Cd-017

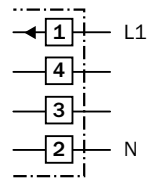

Cd-018

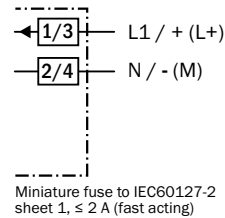

Cd-019

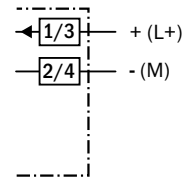

Cd-030

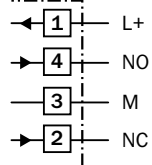

Installation note

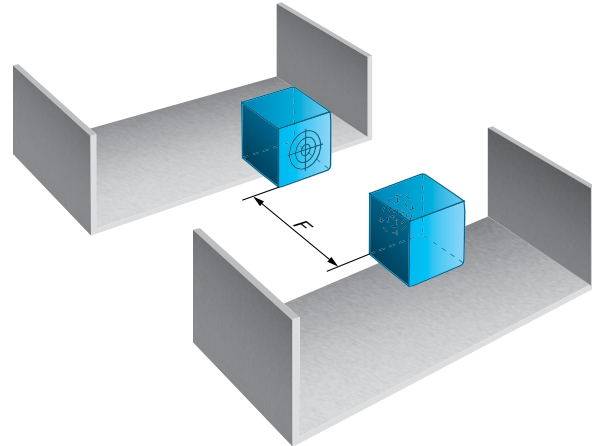
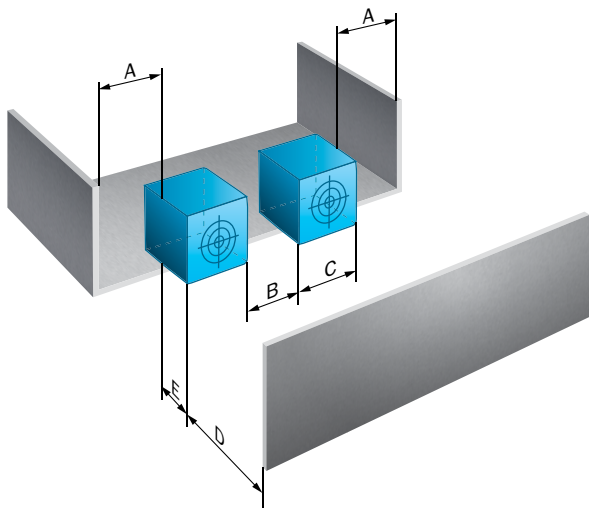

	Electrical wiring	Installation type	A	B	C	D	E	F
IQ40-15Bxx-xx0	DC 3-wire, AC/DC 2-wire	Flush	0 mm	40 mm	40 mm	45 mm	0 mm	120 mm
IQ40-20Nxx-xx0	DC 3-wire, AC/DC 2-wire	Non-flush	80 mm	80 mm	40 mm	60 mm	0 mm	120 mm
IQ40-15Bxx-xx1	DC 4-wire, DC 2-wire, AC 2-wire	Flush	0 mm	60 mm	40 mm	45 mm	0 mm	80 mm
IQ40-20Nxx-xx1	DC 4-wire	Non-flush	0 mm	120 mm	40 mm	60 mm	25 mm	120 mm

C

Rugged and flat in 80 x 80 mm housing

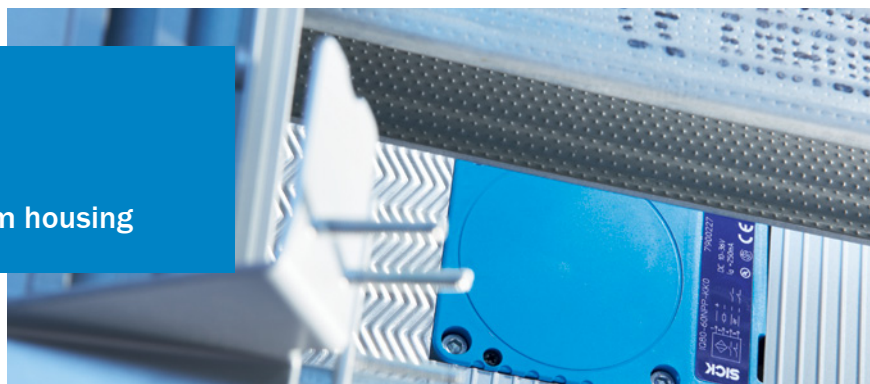

Product description

The rugged IQ80 inductive proximity product family enables reliable detection at up to 60 mm. This sensor provides

fast mounting, simple adjustment and quick changeover during maintenance.

At a glance

- Operating distance adjustable to 60 mm
- Wire configurable NO or NC function
- Terminal or M12 connection
- DC and AC/DC versions available

Your benefits

- Increased machine throughput with less machine downtime
- Maintenance cost reduction and reduced mechanical damage due to long sensing range
- Reduced maintenance cost due to longer service life
- Time-saving quick and easy installation



Additional information

Detailed technical dataC-191
 Ordering informationC-192
 Dimensional drawingsC-192
 Connection diagramC-193
 Installation noteC-194
 Recommended accessoriesC-194

→ www.mysick.com/en/IQ80
 For more information, just enter the link or scan the QR code and get direct access to technical data, CAD design models, operating instructions, software, application examples and much more.



Detailed technical data

Features

	AC/DC 2-wire	DC 3-wire	DC 4-wire
Dimensions (W x H x D) in mm	80 x 40 x 105		80 x 40 x 112
Sensing range S_n	60 mm		50 mm
Assured sensing range S_a	48.6 mm		40.5 mm
Installation type	Non-flush		Flush, non-flush, overflush
Switching frequency	4 Hz	100 Hz	70 Hz
Output type	PNP, NPN	PNP	
Output function	NO or NC, wire configurable		Complementary
Electrical wiring	AC/DC 2-wire	DC 3-wire	DC 4-wire
Enclosure rating ¹⁾	IP 65		IP 67

¹⁾ According to EN60529.

Mechanical / electrical

	AC/DC 2-wire	DC 3-wire	DC 4-wire
Supply voltage	20 V AC/DC ... 250 V AC/DC	10 V DC ... 36 V DC	
Voltage drop	≤ 6.5 V (AC)	≤ 2.5 V ¹⁾	
Current consumption	–	≤ 15 mA ²⁾	≤ 20 mA ²⁾
Hysteresis	1 % ... 15 %		3 % ... 20 %
Temperature drift (% of S_r)	± 10 %		± 15 %
EMC	According to EN 60947-5-2		
Output current I_a	≤ 350 mA, AC (+50 °C)	≤ 250 mA	
Off-state current	≤ 2.5 mA (AC 250 V)	≤ 0.5 mA	–
Load resistance, min.	> 5 mA	–	
Short-time withstand current ³⁾	2.2 A	–	
Connection type	Cable gland, M20 x 1.5		Connector, M12
Short-circuit protection	– ⁴⁾	✓	
Reverse polarity protection	–	✓	
Power-up pulse protection	–	✓	
Shock/vibration	30 g, 11 ms/10 ... 55 Hz, 1 mm		
Ambient operating temperature	–25 °C ... +80 °C		–25 °C ... +70 °C
Housing material	Plastic, PPE		Metal, Zinc diecast
Sensing face material	Plastic, PPE		
Reduction factor R_m	The values are reference values which may vary		
Stainless steel (V2A, 304)	0.7	0.85	
Aluminum (Al)	0.3	0.46	
Copper (Cu)	0.2	0.38	
Brass (Br)	0.4	0.48	

¹⁾ With I_a max and U_b 24 V.

²⁾ Without load.

³⁾ 20 ms/ 0.5 Hz.

⁴⁾ Miniature fuse as per IEC 60217-2 Sheet 1, ≤ 2 A (quick-blow)

C

Ordering information

AC/DC 2-wire

Sensing range	Installation	Output function	Output type	Connection	Connection diagram	Model name	Part no.
60 mm	Non-flush	NC or NO	PNP, NPN	Terminal connection with M20 gland	Cd-025	IQ80-60NUP-KK0	7902138

DC 3-wire

Sensing range	Installation	Output function	Output type	Connection	Connection diagram	Model name	Part no.
60 mm	Non-flush	NC or NO	PNP	Terminal connection with M20 gland	Cd-024	IQ80-60NPP-KK0	7900227

DC 4-wire

Sensing range	Installation	Output function	Output type	Connection	Connection diagram	Model name	Part no.
50 mm	Flush, non-flush, overflush	Complementary	PNP	Connector M12, 4-pin	Cd-009	IQ80-50BPP-KC0	6026473

Dimensional drawings

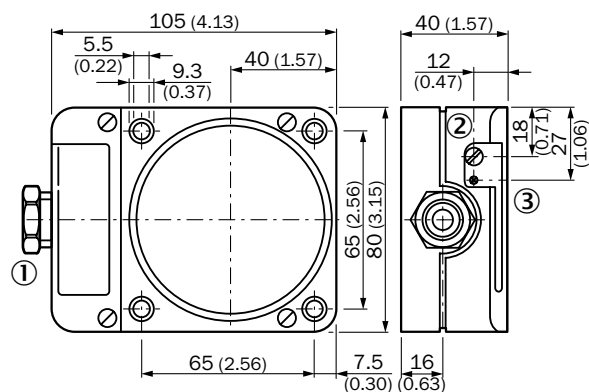
IQ80-60NUP-KK0,
AC/DC 2-wire

All dimensions in mm (inch)

- ① Connection
- ② Potentiometer
- ③ LED indicator

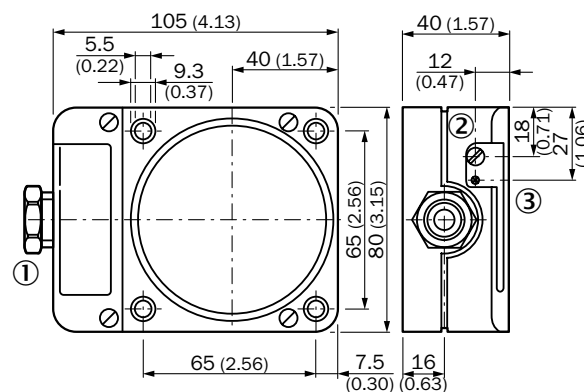
IQ80-60NPP-KK0,
DC 3-wire

All dimensions in mm (inch)

- ① Connection
- ② Potentiometer
- ③ LED indicator

IQ80-50BPP-KC0,
DC 4-wire

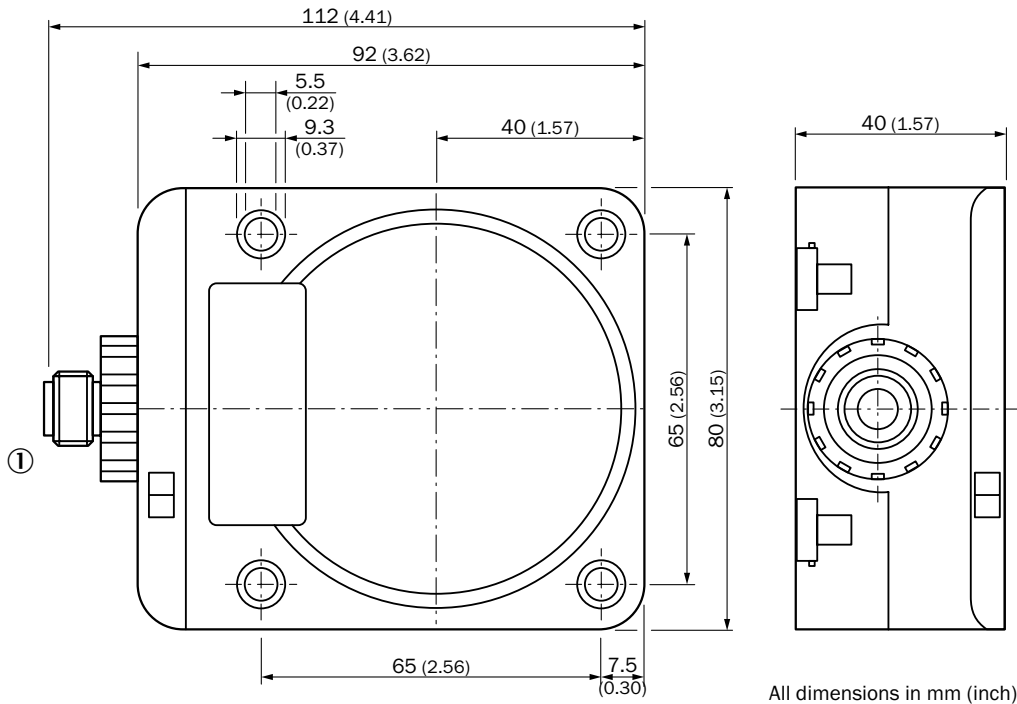

All dimensions in mm (inch)

① Connection

Connection diagram

Cd-009

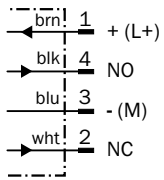

Cd-024

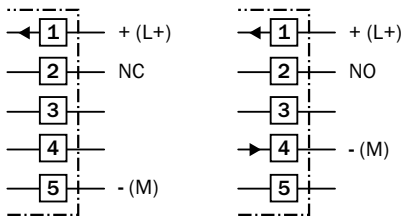

Cd-025

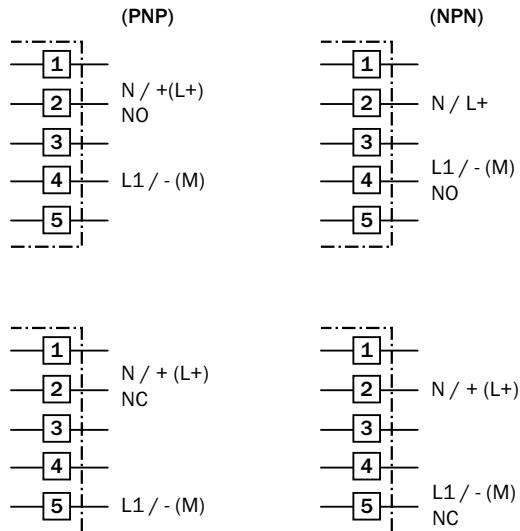

Installation note

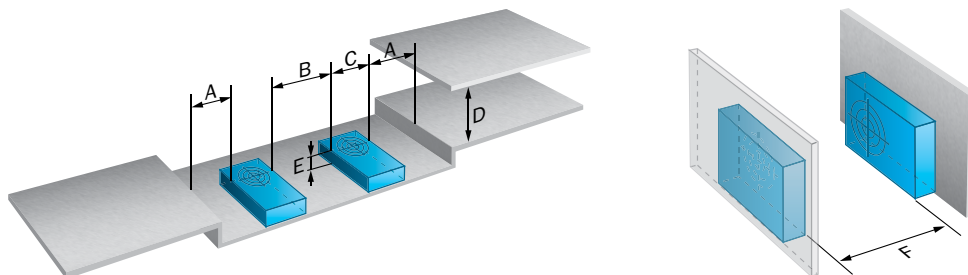

	Installation type	A	B	C	D	E	F
IQ80-xxBxx-xxx	Flush	0 mm	80 mm	80 mm	150 mm	0 mm	400 mm
IQ80-xxNxx-xxx	Non-flush	160 mm	160 mm	80 mm	120 mm	40 mm	480 mm

C

Recommended accessories

Cordsets and connectors

Connector M12, 4-pin

- Connector type: Female connector
- Jacket material: PVC

Figure	Enclosure rating	Configuration	Cable length	Model name	Part no.
	IP 67	Straight	2 m	DOL-1204-G02M	6009382
			5 m	DOL-1204-G05M	6009866
			10 m	DOL-1204-G10M	6010543
	IP 68	Right angle	2 m	DOL-1204-L02M	6027945
			5 m	DOL-1204-L05M	6027944
	IP 67	Right angle	2 m	DOL-1204-W02M	6009383
			5 m	DOL-1204-W05M	6009867

→ For additional accessories, please see page G-255

C



Detection of metallic and non-metallic objects

When you need to know what is hidden behind a surface – a wall, for example, or in a storage container, shipping container, or behind a cover – capacitive proximity sensors are the solution. From solid materials like paper or wood, to granules or liquids, the status of the product can be reliably detected during the production process and on final inspection. Is there something behind that cover? Is the filled package really full? How much paint is still left in the tank? For capacitive sensors, these are easy questions to answer.

SICK's capacitive sensors are never far from the action. Sensing ranges between 1 and 25 mm allow them to be used in nearly all installation situations, making them extremely adaptable for a wide range of applications. These sensors are also remarkably resistant to malfunctions. Impurities, contamination, dust, and airborne spray particles have little effect on them, nor does electromagnetic interference. No wonder they are installed in a wide range of industries, such as food, automotive or in handling and warehousing systems.





D

Capacitive Proximity Sensors

Selection guides **D-198**

Product family overview **D-200**



CM **D-202**

Sensors in cylindrical housing



CM PTFE **D-210**

Sensors in cylindrical PTFE-housing that withstand tough environments



CQ **D-214**

Reliable capacitive proximity sensors enclosed in a rectangular housing

Just a few steps to the right capacitive proximity sensor

	CM18	CM30	CM18 PTFE	CQ28	CQ35
Which design is required?					
Cylindrical threaded	■	■	■		
Rectangular				■	■
What size is required?					
M18	■		■		
M30		■			
28 x 46 x 5.5 mm				■	
35 x 15 x 57.5 mm					■
What maximum sensing range is required?					
≤ 8 mm	■		■		
≤ 10 mm				■	
≤ 12 mm	■ ¹⁾				
≤ 16 mm		■			
≤ 25 mm		■ ¹⁾			■ ¹⁾
What output type is required?					
DC 4-wire	■	■	■	■	■
AC 2-wire		■			
What housing material should the sensor have?					
Plastic	■	■		■	■
PTFE			■		
What type of connection is required?					
Connector	■	■	■	■	■
Cable	■	■	■	■	■
From page	D-202	D-202	D-210	D-214	D-214

SICK can also offer customized solutions. You can find more information in Chapter F.

¹⁾ Maximum sensing range when not mounted flush.

D

Capacitive proximity sensor sensing ranges at a glance

Product family	Max. sensing range (mm)												Page
	1	2	3	4	6	8	10	12	16	20	25		
CM18				3 mm ... 8 mm / 3 mm ... 12 mm ¹⁾									D-202
CM30			2 mm ... 16 mm / 4 mm ... 25 mm ¹⁾									D-202	
CM18 PTFE				3 mm ... 8 mm									D-210
CQ28		1 mm ... 10 mm											D-214
CQ35				4 mm ... 25 mm ¹⁾								D-214	

¹⁾ Maximum sensing range when not mounted flush.

Product family overview



CM

Sensors in cylindrical housing

Technical data overview

Housing	Cylindrical
Thread size	M18 x 1 M30 x 1.5
Dimensions (W x H x D)	-
Sensing range S_n	8 mm / 12 mm / 16 mm / 25 mm
Sensitivity adjustment	Potentiometer
Housing material	Thermoplastic polyester
Enclosure rating	IP 67
Connection	Connector M12, 4-pin / Cable, 4-wire / Cable, 2-wire
Electrical wiring	DC 4-wire / AC 2-wire

At a glance

- M18 or M30 cylindrical housing
- Detects powders, granulates, liquids and solids.
- Best-in-class electromagnetic compatibility
- 4-wire DC (CM18 and CM30) and 2-wire AC versions (CM30)
- Supply voltage: 10 ... 40 VDC (CM18 and CM30), 20 V... 250 VAC (CM30)
- Short-circuit reverse polarity and power-up pulse suppression protection
- LED status indicator
- IP 67 enclosure rating

Detailed information

→ D-202

D



CM PTFE

Sensors in cylindrical PTFE-housing that withstand tough environments



CQ

Reliable capacitive proximity sensors enclosed in a rectangular housing

	Cylindrical M18 x 1	Rectangular -
	-	28 mm x 46 mm x 5.5 mm 35 mm x 15 mm x 69.5 mm 35 mm x 15 mm x 57.5 mm
	8 mm	10 mm / 25 mm
	Potentiometer	Teach-in button, teach-in via cable (CQ28) Potentiometer (CQ35)
	PTFE	PBT (CQ28) / PC (CQ35)
	IP 67	IP 67 / IP 68
	Cable, 4-wire	Connector M12, 4-pin / Cable, 4-wire
	DC 4-wire	DC 4-wire
	<ul style="list-style-type: none"> • M18 cylindrical housing • Detects powders, granulates, liquids and solids • Best-in-class electromagnetic compatibility • Electrical design: DC 4-wire • Supply voltage: DC 10 ... 40 V • Short-circuit, reverse polarity and power-up pulse suppression protection • Housing material made from PTFE • IP 67 enclosure rating 	<ul style="list-style-type: none"> • Rectangular housing • Detects powders, granulates, liquids and solids. • Best-in-class high electromagnetic compatibility • Electrical design: DC 4-wire • Supply voltage: CQ35 10 ... 40 VDC and CQ28 10...30 VDC • Short-circuit, reverse polarity and power-up pulse suppression protection
	→ D-210	→ D-214

D

Sensors in cylindrical housing



D

Product description

Capacitive sensors can detect all powdery, granulated, liquid and solid materials even through plastic walls. SICK' s capacitive sensors feature a high

electromagnetic compatibility (EMC), which prevents false switches and sensor failure.

At a glance

- Cylindrical housing
- Detects powders, granulates, liquids and solids.
- Best-in-class electromagnetic compatibility
- 4-wire DC (CM18 and CM30) and 2-wire AC versions (CM30)
- Supply voltage: 10 ... 40 VDC (CM18 and CM30), 20 V... 250 VAC (CM30)
- Short-circuit reverse polarity and power-up pulse suppression protection
- LED status indicator
- IP 67 enclosure rating

Your benefits

- Durable housing withstands harsh industrial applications, reducing maintenance costs and downtime
- Quick and easy adjustment of the switching point saves installation and setup time
- Application flexibility - solves applications where other sensing technologies cannot provide a solution
- High shock and vibration resistance increases sensor life and reduces maintenance costs
- Non-contact level measurement, even through container or tank walls, reduces installation and setup time



Additional information

- Detailed technical data.....D-203
- Ordering information.....D-204
- Dimensional drawings.....D-205
- Connection diagram.....D-206
- Installation note.....D-206
- Recommended accessories....D-207

→ www.mysick.com/en/CM
For more information, just enter the link or scan the QR code and get direct access to technical data, CAD design models, operating instructions, software, application examples and much more.



Detailed technical data

Features

	DC 4-wire	AC 2-wire
Housing	M18 x 1 / M30 x 1.5	
Sensing range S_n		
M18, flush	3 mm ... 8 mm	–
M30, flush	2 mm ... 16 mm	2 mm ... 16 mm
M18, non-flush	3 mm ... 12 mm	–
M30, non-flush	4 mm ... 25 mm	4 mm ... 25 mm
Assured sensing range S_a		
M18, flush	5.76 mm	–
M30, flush	11.52 mm	11.52 mm
M18, non-flush	8.64 mm	–
M30, non-flush	18 mm	18 mm
Installation type	Flush / Non-flush	
Switching frequency		
M18	30 Hz	–
M30	50 Hz	10 Hz
Output type	PNP / NPN	–
Output function	Complementary	NC or NO, wire configurable
Electrical wiring	DC 4-wire	AC 2-wire
Enclosure rating ¹⁾	IP 67	
Sensitivity adjustment	Potentiometer (270°)	Potentiometer (multi-turn)

¹⁾ According to EN60529.

Mechanical / electrical

	DC 4-wire	AC 2-wire
Supply voltage	10 V DC ... 40 V DC	20 V AC ... 250 V AC
Ripple ¹⁾	≤ 10 %	
Voltage drop ²⁾	≤ 2.5 V DC	≤ 10 V DC
Current consumption ³⁾	≤ 10 mA	
Time delay before availability	≤ 100 ms	
Hysteresis	4 % ... 20 %	
Repeatability ^{4) 5)}	≤ 5 %	
Temperature drift (% of S_r)	± 10 %	
EMC	According to EN 60947-5-2	
Output current I_a	≤ 200 mA	≤ 500 mA
Connection type	Connector, M12 / Cable, 2 m, PVC ⁶⁾	Cable, 2 m, PVC ⁶⁾
Short-circuit protection	✓	–
Reverse polarity protection	✓	
Power-up pulse protection	✓	
Shock/vibration	30 g, 11 ms/10 ... 55 Hz, 1 mm	
Ambient operating temperature	–25 °C ... +80 °C	
Housing material	Thermoplastic polyester	

	DC 4-wire	AC 2-wire
Housing cap material	Thermoplastic polyester	
Tightening torque, max.		
M18	2.6 Nm	-
M30	7.5 Nm	7.5 Nm
Reduction factor R_m	The values are reference values which may vary	
Metal	1	
Water	1	
PVC	0.4	
Oil	0.25	

- ¹⁾ Of Ub.
- ²⁾ At I_a max.
- ³⁾ Without load.
- ⁴⁾ Of Sr.
- ⁵⁾ Ub and Ta constant.
- ⁶⁾ Do not bend below 0 °C.

Ordering information

DC 4-wire

Housing	Sensing range S_n	Installation type	Output type	Connection	Connection diagram	Model name	Part no.
M18 x 1	3 mm ... 8 mm	Flush	PNP	Connector M12, 4-pin	Cd-006	CM18-08BPP-KC1	6020388
				Cable, 4-wire, 2 m, PVC	Cd-005	CM18-08BPP-KW1	6020136
			NPN	Connector M12, 4-pin	Cd-006	CM18-08BNP-KC1	6021456
				Cable, 4-wire, 2 m, PVC	Cd-005	CM18-08BNP-KW1	6021455
	3 mm ... 12 mm	Non-flush	PNP	Connector M12, 4-pin	Cd-006	CM18-12NPP-KC1	6020410
				Cable, 4-wire, 2 m, PVC	Cd-005	CM18-12NPP-KW1	6020389
NPN			Connector M12, 4-pin	Cd-006	CM18-12NNP-KC1	6021458	
			Cable, 4-wire, 2 m, PVC	Cd-005	CM18-12NNP-KW1	6021457	
M30 x 1.5	2 mm ... 16 mm	Flush	PNP	Connector M12, 4-pin	Cd-006	CM30-16BPP-KC1	6020475
				Cable, 4-wire, 2 m, PVC	Cd-005	CM30-16BPP-KW1	6020473
			NPN	Connector M12, 4-pin	Cd-006	CM30-16BNP-KC1	6021460
				Cable, 4-wire, 2 m, PVC	Cd-005	CM30-16BNP-KW1	6021459
	4 mm ... 25 mm	Non-flush	PNP	Connector M12, 4-pin	Cd-006	CM30-25NPP-KC1	6020477
				Cable, 4-wire, 2 m, PVC	Cd-005	CM30-25NPP-KW1	6020476
			NPN	Connector M12, 4-pin	Cd-006	CM30-25NNP-KC1	6021462
				Cable, 4-wire, 2 m, PVC	Cd-005	CM30-25NNP-KW1	6021461

AC 2-wire

Housing	Sensing range S_n	Installation type	Connection	Connection diagram	Model name	Part no.
M30 x 1.5	2 mm ... 16 mm	Flush	Cable, 2-wire, 2 m, PVC	Cd-013	CM30-16BAP-KW1	6028411
	4 mm ... 25 mm	Non-flush	Cable, 2-wire, 2 m, PVC	Cd-013	CM30-25NAP-KW1	6028413

Dimensional drawings

CM18-xxBxx-xCx, M18, flush, connector

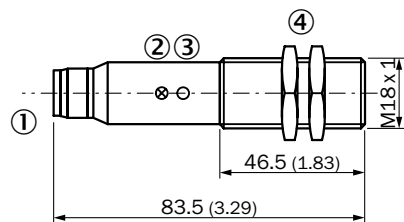

All dimensions in mm (inch)

- ① Connection
- ② LED indicator
- ③ Potentiometer
- ④ Fastening nuts (2 x); 34 mm hex, plastic

CM18-xxBxx-xWx, M18, flush, cable

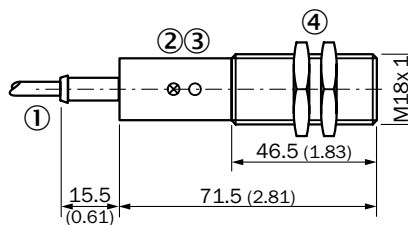

All dimensions in mm (inch)

- ① Connection
- ② LED indicator
- ③ Potentiometer
- ④ Fastening nuts (2 x); 34 mm hex, plastic

CM18-xxNxx-xCx, M18, non-flush, connector

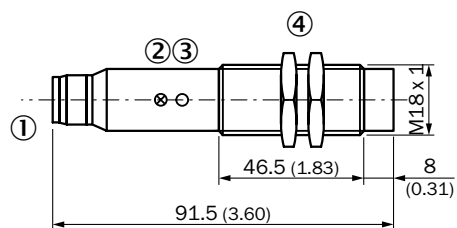

All dimensions in mm (inch)

- ① Connection
- ② LED indicator
- ③ Potentiometer
- ④ Fastening nuts (2 x); 34 mm hex, plastic

CM18-xxNxx-xWx, M18, non-flush, cable

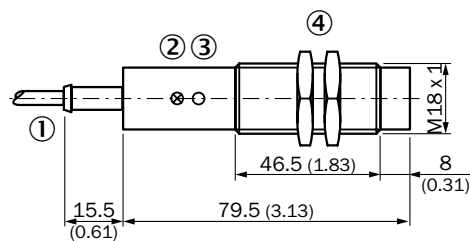

All dimensions in mm (inch)

- ① Connection
- ② LED indicator
- ③ Potentiometer
- ④ Fastening nuts (2 x); 34 mm hex, plastic

CM30-xxBxx-xCx, M30, flush, connector

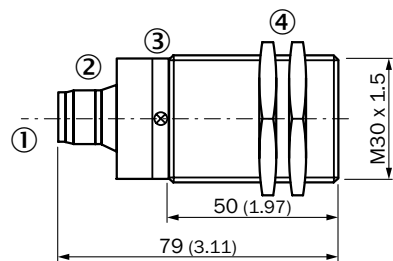

All dimensions in mm (inch)

- ① Connection
- ② Potentiometer
- ③ LED indicator
- ④ Fastening nuts (2 x); 36 mm hex, plastic

CM30-xxBxx-xWx, M30, flush, cable

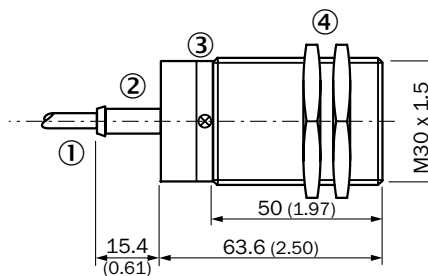

All dimensions in mm (inch)

- ① Connection
- ② LED indicator
- ③ Potentiometer
- ④ Fastening nuts (2 x); 34 mm hex, plastic

CM30-xxNxx-xCx,
M30, non-flush, connector

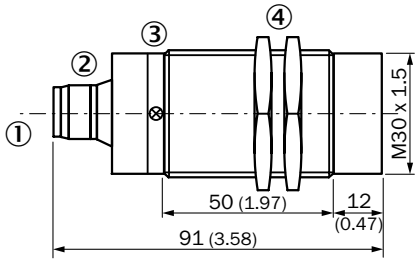

All dimensions in mm (inch)

- ① Connection
- ② Potentiometer
- ③ LED indicator
- ④ Fastening nuts (2 x); 36 mm hex, plastic

CM30-xxNxx-xWx,
M30, non-flush, cable

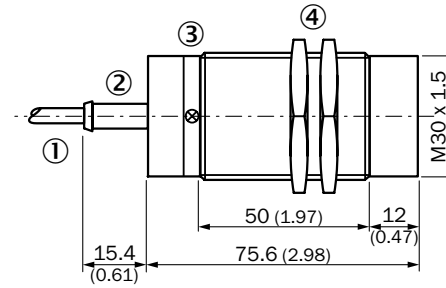

All dimensions in mm (inch)

- ① Connection
- ② LED indicator
- ③ Potentiometer
- ④ Fastening nuts (2 x); 36 mm hex, plastic

Connection diagram

Cd-005

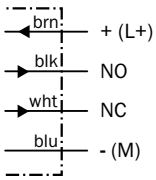

Cd-006

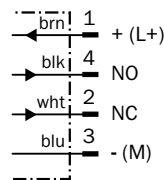

Cd-013

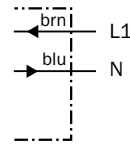

D

Installation note

Flush installation

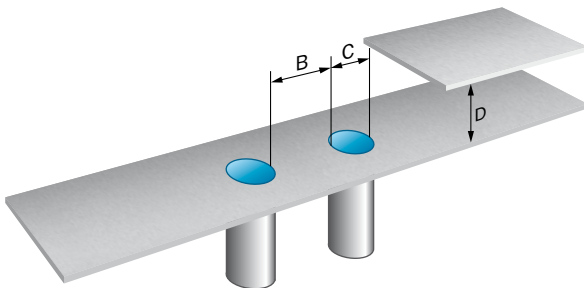

Non-flush installation

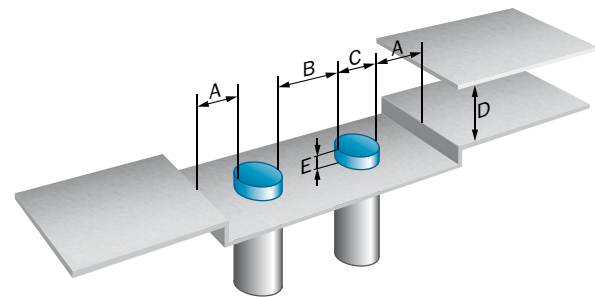



	Housing	Installation type	A	B	C	D	E ¹⁾
CM18-08Bxx-xxx	M18	Flush	-	18 mm	18 mm	24 mm	-
CM18-12Nxx-xxx	M18	Non-flush	18 mm	36 mm	18 mm	36 mm	≥ 24 mm
CM30-16Bxx-xxx	M30	Flush	-	30 mm	30 mm	48 mm	-
CM30-25Nxx-xxx	M30	Non-flush	30 mm	60 mm	30 mm	75 mm	≥ 50 mm

¹⁾ In critical distances, the sensor should be tested in the application.





Recommended accessories

Mounting brackets

Figure	Accessory type	Material	Thread size	Configuration	Model name	Part no.	CM18	CM30
	Mounting brackets	Steel, zinc coated	M18	Straight	BEF-WG-M18	5321870	●	-
				Right angle	BEF-WN-M18	5308446	●	-
			M30	Right angle	BEF-WN-M30	5308445	-	●





Cordsets and connectors

Connector M12, 4-pin

Figure	Connector type	Configuration	Enclosure rating	Jacket material	Cable length	Model name	Part no.	
	Female connector	Straight	IP 67	PVC	2 m	DOL-1204-G02M	6009382	
					5 m	DOL-1204-G05M	6009866	
IP 68			PUR halogen free	2 m	DOL-1204-G02MC	6025900		
				5 m	DOL-1204-G05MC	6025901		
Right angle		IP 67	PVC	2 m	DOL-1204-W02M	6009383		
				5 m	DOL-1204-W05M	6009867		
		IP 68	PUR halogen free	2 m	DOL-1204-W02MC	6025903		
				5 m	DOL-1204-W05MC	6025904		
		Male connector	Straight	IP 67	PBT	-	DOS-1204-G	6007302
Right angle			PBT			-	DOS-1204-W	6007303
			Straight	IP 67	PBT	-	STE-1204-G	6009932
			Right angle			PBT	-	STE-1204-W

D

Terminal and alignment brackets

Figure	Description	Material	Model name	Part no.	CM18	CM30
	Terminal brackets M18, without fixed stop	Plastic (PA12), glass-fiber reinforced	BEF-KH-M18	2051481	●	-
	Terminal brackets M18, with fixed stop	Plastic (PA12), glass-fiber reinforced	BEF-KHF-M18	2051482	●	-
	Universal bar clamp systems	Zinc plated steel (sheet), Diecast zinc (clamp)	BEF-KHS-N06	2051612	●	-
		Stainless steel 1.4571 (sheet), Stainless steel 1.4408 (clamp)	BEF-KHS-N06N	2051622	●	-
		Zinc plated steel (sheet), Diecast zinc (clamp)	BEF-KHS-N10	2062372	-	●
		Stainless steel 1.4571 (sheet), Stainless steel 1.4408 (clamp)	BEF-KHS-N10N	2062373	-	●
		Steel, zinc coated	BEF-MS12G-A	4056054	●	●
		Stainless steel (1.4571)	BEF-MS12G-NA	4058914	●	●
		Aluminum	BEF-RMC-D12	5321878	●	●

→ For additional accessories, please see page G-255

D

D

Sensors in cylindrical PTFE-housing that withstand tough environments



Product description

Capacitive sensors can detect all powdery, granulated, liquid and solid materials even through plastic walls. The CM18 PTFE is ideal for checking the fill level of acids, alkalis or solvents. It is also used

for presence detection in aggressive environments with fumes and mists. The PTFE-housing is resistant to almost all chemicals and organic solvents.

At a glance

- M18 - Cylindrical housing
- Detects powders, granulates, liquids and solids
- Best-in-class electromagnetic compatibility
- Electrical design: DC 4-wire
- Supply voltage: DC 10 ... 40 V
- Short-circuit, reverse polarity and power-up pulse suppression protection
- Housing material made from PTFE
- IP 67 enclosure rating

Your benefits

- Fewer maintenance costs due to a durable PTFE (Teflon ®) housing that withstands harsh industrial applications
- Quick and easy adjustment via potentiometer saves installation and setup time
- Simple, cost-saving detection alternative to photoelectric and inductive sensors in applications such as detecting product in a sealed box, container or tank
- High EMC immunity prevents false switching, which reduces material loss and increases throughput
- High shock and vibration resistance increases sensor life and reduces maintenance costs



Additional information

- Detailed technical dataD-211
- Ordering informationD-212
- Dimensional drawingsD-212
- Connection diagramD-212
- Installation noteD-212
- Recommended accessoriesD-213

→ www.mysick.com/en/CM_PTFE

For more information, just enter the link or scan the QR code and get direct access to technical data, CAD design models, operating instructions, software, application examples and much more.



D

Detailed technical data

Features

Housing	M18
Sensing range S_n	3 mm ... 8 mm
Assured sensing range S_a	5.76 mm
Installation type	Flush
Switching frequency	30 Hz
Output type	NPN / PNP
Output function	Complementary
Electrical wiring	DC 4-wire
Enclosure rating ¹⁾	IP 67
Sensitivity adjustment	Potentiometer (270°)

¹⁾ According to EN60529.

Mechanical / electrical

Supply voltage	10 V DC ... 40 V DC
Ripple ¹⁾	≤ 10 %
Voltage drop ²⁾	≤ 2.5 V DC
Current consumption ³⁾	≤ 10 mA
Time delay before availability	≤ 100 ms
Hysteresis	4 % ... 20 %
Repeatability ^{4) 5)}	≤ 5 %
Temperature drift (% of S_r)	± 10 %
EMC	According to EN 60947-5-2
Output current I_a	≤ 200 mA
Connection type ⁶⁾	Cable, 2 m, PVC
Short-circuit protection	✓
Reverse polarity protection	✓
Power-up pulse protection	✓
Shock/vibration	30 g, 11 ms/10 ... 55 Hz, 1 mm
Ambient operating temperature	-25 °C ... +60 °C
Housing material	PTFE
Housing cap material	PTFE
Tightening torque, max.	≤ 2.6 Nm
Reduction factor R_m	The values are reference values which may vary
	Metal 1
	Water 1
	PVC 0.4
	Oil 0.25

¹⁾ Of U_b .

²⁾ At I_a max.

³⁾ Without load.

⁴⁾ Of S_r .

⁵⁾ U_b and T_a constant.

⁶⁾ Do not bend below 0 °C.

Ordering information

Output type	Connection diagram	Model name	Part no.
NPN	Cd-005	CM18-08BNP-TW0	6026194
PNP	Cd-005	CM18-08BPP-TW0	6026195

Dimensional drawings

**CM18-xxBxx-TWx,
cable**

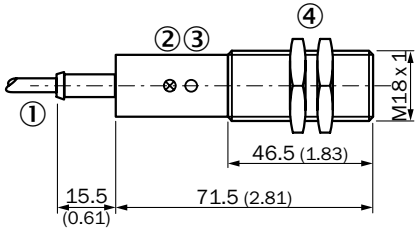

All dimensions in mm (inch)

- ① Connection
- ② LED indicator
- ③ Potentiometer
- ④ Fastening nuts (2 x); 34 mm hex, plastic

dimensions in mm

Connection diagram

Cd-005

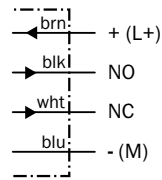

D

Installation note

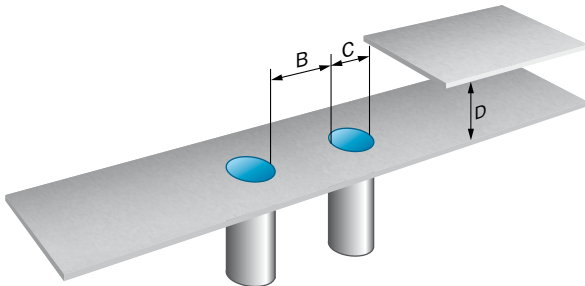

Flush installation



	B	C	D
CM18-08Bxx-xxx	18 mm	18 mm	24 mm

Recommended accessories





Mounting brackets

Figure	Accessory type	Material	Thread size	Configuration	Model name	Part no.
	Mounting brackets	Stainless steel	M18	Straight	BEF-WG-M18N	5320948
				Right angle	BEF-WN-M18N	5320947





Cordsets and connectors

Connector M12, 4-pin

- Enclosure rating: IP 67
- Jacket material: PBT

Figure	Connector type	Configuration	Model name	Part no.
	Female connector	Straight	DOS-1204-G	6007302
		Right angle	DOS-1204-W	6007303
	Male connector	Straight	STE-1204-G	6009932
		Right angle	STE-1204-W	6022084

Terminal and alignment brackets

Figure	Description	Material	Model name	Part no.
	Terminal brackets M18, without fixed stop	Plastic (PA12), glass-fiber reinforced	BEF-KH-M18	2051481
	Terminal brackets M18, with fixed stop	Plastic (PA12), glass-fiber reinforced	BEF-KHF-M18	2051482
	Universal bar clamp systems	Stainless steel 1.4571 (sheet), Stainless steel 1.4408 (clamp)	BEF-KHS-N06N	2051622
		Stainless steel (1.4571)	BEF-MS12G-NA	4058914
		Aluminum	BEF-RMC-D12	5321878
	Alignment brackets	Plastic	BEF-WN-M18-ST02	5312973

→ For additional accessories, please see page G-255

Reliable capacitive proximity sensors enclosed in a rectangular housing

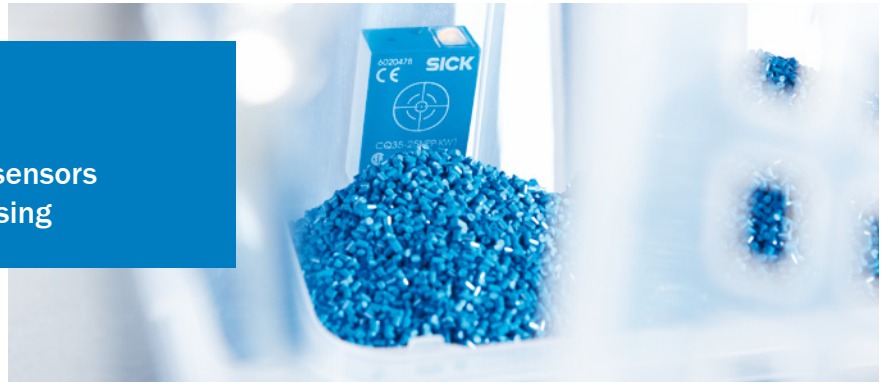

Product description

Capacitive sensors can detect all powdery, granulated, liquid and solid materials even through plastic walls. SICK's capacitive sensors feature a high electromagnetic compatibility (EMC),

which prevents false switches and sensor failure.

CQ capacitive sensors feature a rectangular housing that is suitable for different installation situations.

At a glance

- Rectangular housing
- Detects powders, granulates, liquids and solids.
- Best-in-class high electromagnetic compatibility
- Electrical design: DC 4-wire
- Supply voltage: CQ35 10 ... 40 VDC and CQ28 10...30 VDC
- Short-circuit, reverse polarity and power-up pulse suppression protection

Your benefits

- Non-contact level measurement, even through container or tank walls, which eliminates drilling holes and thus reduces installation time
- Durable housing withstands harsh industrial applications, reducing maintenance costs
- Quick and easy adjustment of the switching point - via pushbutton, remote teach for the CQ28 and via potentiometer for CQ35 - saves time
- Simple and safe detection alternative to photoelectric and inductive sensors in applications such as detecting product in a sealed box, container or tank



Additional information

Detailed technical data.....	D-215
Ordering information.....	D-216
Dimensional drawings.....	D-216
Connection diagram.....	D-217
Installation note.....	D-217
Recommended accessories.....	D-218

→ www.mysick.com/en/CQ

For more information, just enter the link or scan the QR code and get direct access to technical data, CAD design models, operating instructions, software, application examples and much more.



Detailed technical data

Features

	CQ28	CQ35
Dimensions (W x H x D)	28 mm x 46 mm x 5.5 mm	35 mm x 15 mm x 69.5 mm / 35 mm x 15 mm x 57.5 mm
Sensing range S_n	1 mm ... 10 mm	4 mm ... 25 mm
Assured sensing range S_a	7.2 mm	18 mm
Installation type	Flush	Non-flush
Switching frequency	10 Hz	50 Hz
Output type	PNP / NPN	
Output function	NC or NO, wire configurable	Complementary
Electrical wiring	DC 4-wire	
Enclosure rating ¹⁾	IP 68	IP 67
Sensitivity adjustment	Teach-in button, teach-in via cable	Potentiometer (270°)

¹⁾ According to EN60529.

Mechanical / electrical

	CQ28	CQ35
Supply voltage	10 V DC ... 30 V DC	10 V DC ... 40 V DC
Ripple	≤ 10 %	≤ 10 % ¹⁾
Voltage drop ²⁾	≤ 2.5 V DC	
Current consumption ³⁾	≤ 12 mA	≤ 10 mA
Time delay before availability	≤ 300 ms	≤ 100 ms
Hysteresis	Depending on Teach-in	4 % ... 20 %
Repeatability ^{4) 5)}	≤ 5 %	
Temperature drift (% of S_r)	± 10 %	
EMC	According to EN 60947-5-2	
Output current I_a	≤ 200 mA	
Connection type	Cable, 2 m, PVC ⁶⁾	Connector, M12 / Cable, 2 m, PVC ⁶⁾
Short-circuit protection	✓	
Reverse polarity protection	✓	
Power-up pulse protection	-	✓
Shock/vibration	30 g, 11 ms/10 ... 55 Hz, 1 mm	
Ambient operating temperature	-20 °C ... +85 °C	-25 °C ... +75 °C
Ambient storage temperature	-40 °C ... +85 °C	-
Housing material	PBT	PC
Reduction factor R_m	The values are reference values which may vary	
	Metal	1
	Water	1
	PVC	0.4
	Oil	0.25

¹⁾ Of U_b .

²⁾ At I_a max.

³⁾ Without load.

⁴⁾ Of S_r .

⁵⁾ U_b and T_a constant.

⁶⁾ Do not bend below 0 °C.

Ordering information

CQ28

- **Installation type:** flush, non-flush
- **Output function:** NC or NO, wire configurable
- **Sensing range S_n :** 1 mm ... 10 mm

Output type	Dimensions (W x H x D)	Connection	Connection diagram	Model name	Part no.
PNP	28 mm x 46 mm x 5.5 mm	Cable, 4-wire, 2 m, PVC	Cd-023	CQ28-10NPP-KW1	6030132
NPN	28 mm x 46 mm x 5.5 mm	Cable, 4-wire, 2 m, PVC	Cd-023	CQ28-10NNP-KW1	6030133

CQ35

- **Installation type:** flush, non-flush
- **Output function:** Complementary
- **Sensing range S_n :** 4 mm ... 25 mm

Output type	Dimensions (W x H x D)	Connection	Connection diagram	Model name	Part no.
PNP	35 mm x 15 mm x 69.5 mm	Connector M12, 4-pin	Cd-006	CQ35-25NPP-KC1	6020479
	35 mm x 15 mm x 57.5 mm	Cable, 4-wire, 2 m, PVC	Cd-005	CQ35-25NPP-KW1	6020478
NPN	35 mm x 15 mm x 69.5 mm	Connector M12, 4-pin	Cd-006	CQ35-25NNP-KC1	6021464
	35 mm x 15 mm x 57.5 mm	Cable, 4-wire, 2 m, PVC	Cd-005	CQ35-25NNP-KW1	6021463

Dimensional drawings

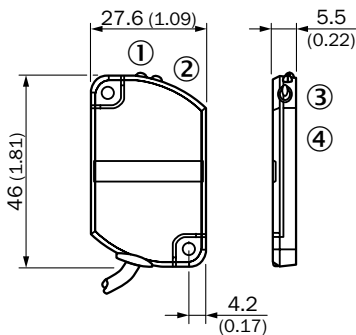
CQ28-xxNxx-xWx,
cable

All dimensions in mm (inch)

- ① LED indicator green
- ② LED indicator yellow
- ③ Teach-in button
- ④ Sensing area

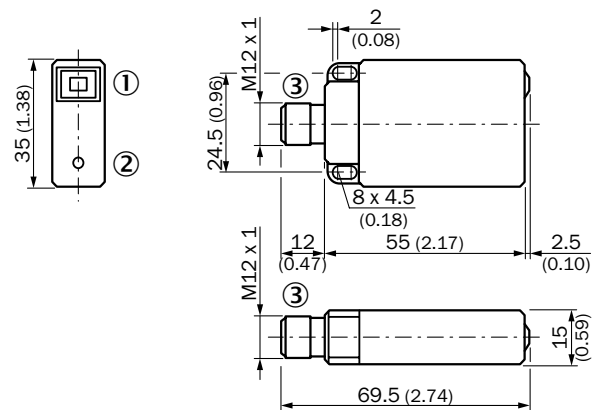
CQ35-xxNxx-xCx,
connector

All dimensions in mm (inch)

- ① LED indicator
- ② Potentiometer
- ③ Connection

CQ35-xxNxx-xWx,
cable

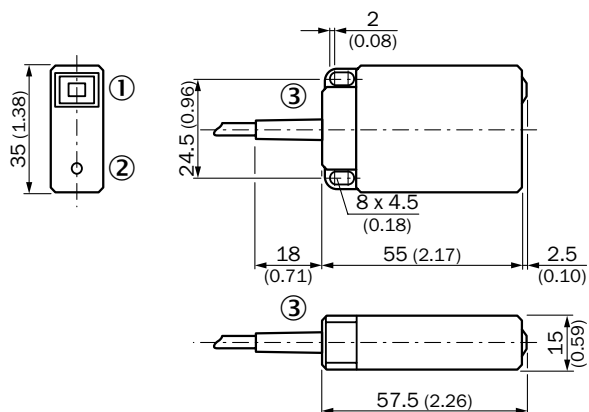

All dimensions in mm (inch)

- ① LED indicator
- ② Potentiometer
- ③ Connection

Connection diagram

Cd-005

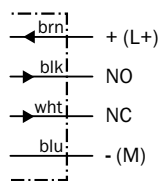

Cd-006

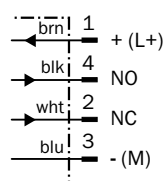

Cd-023

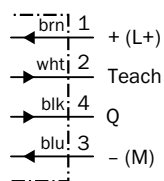

Installation note

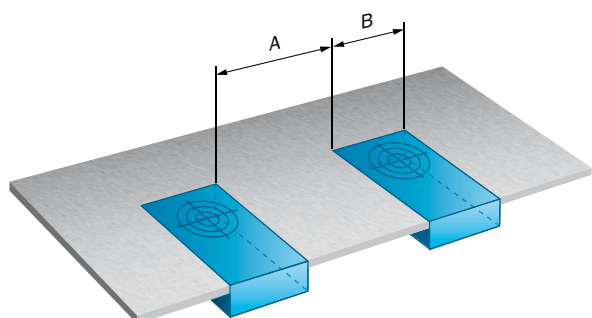







	A	B
CQ28	≥ 27.6 mm	27.6 mm
CQ35	≥ 35 mm	35 mm

Recommended accessories

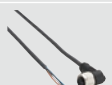
Cordsets and connectors

Connector M12, 4-pin

Figure	Connector type	Configuration	Enclosure rating	Jacket material	Cable length	Model name	Part no.	
	Female connector	Straight	IP 67	PVC	2 m	DOL-1204-G02M	6009382	
5 m					DOL-1204-G05M	6009866		
			IP 68	PUR halogen free	2 m	DOL-1204-G02MC	6025900	
5 m					DOL-1204-G05MC	6025901		
		Right angle	IP 67	PVC	2 m	DOL-1204-W02M	6009383	
5 m					DOL-1204-W05M	6009867		
			IP 68	PUR halogen free	2 m	DOL-1204-W02MC	6025903	
5 m					DOL-1204-W05MC	6025904		
		Male connector	Straight	IP 67	PBT	-	DOS-1204-G	6007302
						Right angle	PBT	-
			Right angle		PBT			-
						-	STE-1204-W	6022084

→ For additional accessories, please see page G-255

D

SICK SICK

SICK SICK

Magnetic proximity sensors with maximum operating distances and a minimal design



SICK offers a comprehensive range of magnetic proximity sensors in cylindrical (MM) and rectangular (MQ) designs. The sensors are available with long operating distances and the Advanced series offers an extended operating distance with entirely new application options opened up due to its smaller magnets. The Namur version of the MM sensors completes this comprehensive series. MQ sensors offer all the advantages of a magnetic proximity sensor in a compact, plastic housing. Magnetic proximity sensors are specially designed for harsh environments since they are resistant to dust, heat and vibration. Typical applications include situations beyond the technological limitations of other sensors.





Magnetic proximity sensors

E

	Selection guides	E-222
	Product family overview	E-224
	MM Magnetic proximity sensors in common M8, M12, and M18 cylindrical housing	E-226
	MM Namur Namur magnetic proximity sensors in a cylindrical housing for explosive areas	E-236
	MQ Magnetic proximity sensors in a rectangular housing	E-244

Just a few steps to the right magnetic proximity sensor

	MM08	MM12	MM18	MM12 Namur	MM18 Namur	MQ10
Which design is required?						
Cylindrical threaded	■	■	■	■	■	
Rectangular						■
What size is required?						
M8	■					
M12		■		■		
M18			■		■	
10.3 x 28 x 16 mm						■
What maximum sensing range is required?						
≤ 60 mm	■					■
≤ 90 mm		■		■		
≤ 120 mm			■		■	
What output type is required?						
DC 3-wire	■	■	■			■
Namur				■	■	
What housing material should the sensor have?						
Plastic						■
Nickel-plated brass	■	■	■	■	■	
Stainless steel V2A			■			
What type of connection is required?						
Connector	■	■	■	■	■	■
Cable	■	■	■	■	■	■
From page	E-226	E-226	E-226	E-236	E-236	E-244
SICK can also offer customized solutions. You can find more information in Chapter F.						

E

Magnetic proximity sensor sensing ranges at a glance

Product family	Max. sensing range (mm) ¹⁾													Page	
	5	10	20	30	40	50	60	70	80	90	100	110	120		
MM08	5 mm ... 60 mm														E-226
MM12	5 mm ... 90 mm													E-226	
MM18	5 mm ... 120 mm													E-226	
MM12 Namur	5 mm ... 90 mm													E-236	
MM18 Namur	5 mm ... 120 mm													E-236	
MQ10	5 mm ... 60 mm													E-244	

¹⁾ Sensing range based on installation in non-magnetic material using Magnet MAG-3010-B (M4.0).

Product family overview



MM

Magnetic proximity sensors in common M8, M12, and M18 cylindrical housing

Technical data overview

Housing	Cylindrical
Thread size	M8 x 1 M12 x 1 M18 x 1
Housing	-
Sensing range S_n	60 mm ... 120 mm
Magnetic field sensitivity, min.	0.4 mT ... 1 mT
Housing material	Nickel-plated brass, stainless steel (V4A)
Enclosure rating	IP 67
Connection	Connector M8, 3-pin / Cable, 3-wire / Connector M12, 4-pin

At a glance

- Reliable detection of permanent magnets through non-ferromagnetic materials such as stainless steel, aluminum, plastic or wood
- Precise switching point and exact hysteresis
- Reliable object detection in high temperature zones
- Small housing with large operating distances
- Resistant to dust, dirt, and vibrations, increasing sensor life and reducing maintenance costs

Detailed information

→ E-226

E



MM Namur

Namur magnetic proximity sensors in a cylindrical housing for explosive areas



MQ

Magnetic proximity sensors in a rectangular housing

	Cylindrical	Rectangular
	M12 x 1 M18 x 1	-
	-	10.3 mm x 37 mm x 16 mm 10.3 mm x 28 mm x 16 mm
	60 mm ... 120 mm	60 mm
	0.4 mT ... 1 mT	1 mT
	Nickel-plated brass	Polyamid
	IP 67	IP 67
	Connector M12, 4-pin / Cable, 2-wire / Cable, 4-wire	Connector M8, 3-pin / Cable, 3-wire / Cable with connector M8, 4-pin

- Detection of permanent magnets through non-ferromagnetic materials, such as stainless steel, aluminum, plastic or wood
- Namur design for usage in hazardous explosive areas
- Suitable for object detection in high temperature areas due to long sensing ranges
- Fits on to standard M12 and M18 installation

→ E-236

- Long sensing distance in a small, compact rectangular plastic housing with an IP 67 enclosure rating
- Detection of permanent magnets through non-ferromagnetic materials such as stainless steel, aluminum, plastic, or wood
- Solves high-temperature applications by installing the temperature-resistant magnet in the high-temperature area and the sensor behind an insulated area
- Non-contact operation that is resistant to dust, dirt, shock and vibration
- Precise switching point and hysteresis
- Sensing distance up to 60 mm
- High switching frequency
- Short-circuit, reverse polarity protection and power-up pulse suppression

→ E-244



Magnetic proximity sensors in common M8, M12, and M18 cylindrical housing



Additional information

Detailed technical data	E-227
Ordering information	E-228
Dimensional drawings	E-229
Connection diagram	E-231
Maximum sensing range	E-231
Recommended accessories	E-233



Product description

MM magnetic proximity sensors provide long sensing ranges that can reliably detect magnetic objects. Magnetic proximity sensors are resistant to dust, heat, vibrations and other harsh environ-

ments. The MM magnetic sensors are enclosed in a cylindrical housing and are available in sizes MM08, MM12 and MM18.

At a glance

- Reliable detection of permanent magnets through non-ferromagnetic materials such as stainless steel, aluminum, plastic or wood
- Precise switching point and exact hysteresis
- Reliable object detection in high temperature zones
- Small housing with large operating distances
- Resistant to dust, dirt, and vibrations, increasing sensor life and reducing maintenance costs

Your benefits

- Non-contact operation eliminates interference from dirt, dust and vibrations, increasing sensor life and reducing maintenance costs
- Space-saving installation due to small design
- Large operating distances with reliable switching increase throughput
- Non-contact, universal detection through several substances, including plastic containers and pipes protective PTFE walls and non-magnetic metal walls

→ www.mysick.com/en/MM

For more information, just enter the link or scan the QR code and get direct access to technical data, CAD design models, operating instructions, software, application examples and much more.



Detailed technical data

Features

		MM08	MM12	MM18
Housing		M8 x 1	M12 x 1	M18 x 1
Sensing range S_n	Standard ¹⁾	0 mm ... 60 mm		0 mm ... 70 mm
	Advanced ¹⁾	-	5 mm ... 90 mm	5 mm ... 120 mm
Assured sensing range S_a	Standard	48.6 mm		56.7 mm
	Advanced	-	72.9 mm	97.2 mm
Magnetic sensitivity	Standard	1 mT		0.7 mT
	Advanced	-	0.6 mT	0.4 mT
Switching frequency	Standard	1,000 Hz		
	Advanced	-	5,000 Hz	
Output type		PNP / NPN		
Output function		NO	NO / NC	
Electrical wiring		DC 3-wire		
Enclosure rating ²⁾		IP 67		
Magnetic alignment		Axial		

¹⁾ Sensing range based on installation in non-magnetic material using Magnet MAG-3010-B (M4.0).

²⁾ According to EN60529.

Mechanical / electrical

		MM08	MM12	MM18
Supply voltage		10 V DC ... 30 V DC		
Ripple ¹⁾		≤ 10 %		
Voltage drop	Standard	≤ 2 V ²⁾		
	Advanced	-	≤ 1.5 V ²⁾	
Current consumption ³⁾		≤ 10 mA		
Time delay before availability	Standard	≤ 20 ms		
	Advanced	-	≤ 2 ms	
Hysteresis		1 % ... 10 %		
Repeatability ⁴⁾		≤ 1 %		
Temperature drift (% of S_p)		± 10 %		
EMC		According to EN 60947-5-2		
Output current I_a	Standard	≤ 200 mA		
	Advanced	-	≤ 300 mA	

¹⁾ Of V_s .

²⁾ At I_a max.

³⁾ Without load.

⁴⁾ Von Sr (VS und Ta constant).

⁵⁾ Do not bend below 0 °C.

⁶⁾ Pulsed.

	MM08	MM12	MM18
Connection type	Cable, 2 m, PUR/PVC ⁵⁾ / Connector M8, 3-pin	Cable, 2 m, PUR/PVC ⁵⁾ / Connector M12, 4-pin	
Short-circuit protection⁶⁾	✓		
Reverse polarity protection	✓		
Power-up pulse protection	✓		
Shock/vibration	30 g, 11 ms/10 ... 55 Hz, 1 mm		
Ambient operating temperature	-25 °C ... +75 °C		
Housing material	Metal, Nickel-plated brass		Stainless steel, V4A / Nickel-plated brass
Tightening torque, max.			
	Standard	6 Nm	15 Nm
	Advanced	–	7 Nm
			40 Nm
			25 Nm

¹⁾ Of V_s .

²⁾ At I_a max.

³⁾ Without load.

⁴⁾ Von Sr (VS und Ta constant).

⁵⁾ Do not bend below 0 °C.

⁶⁾ Pulsed.

Ordering information

MM08

- **Housing:** M8 x 1
- **Housing material:** Nickel-plated brass

Sensing range S_n ¹⁾	Output type	Housing	Output function	Connection	Connection diagram	Model name	Part no.
0 mm ... 60 mm	PNP	Standard	NO	Cable, 3-wire, 2 m, PUR/PVC	Cd-001	MM08-60APS-ZUK	1040027
				Connector M8, 3-pin	Cd-002	MM08-60APS-ZTK	1040067
	NPN	Standard	NO	Cable, 3-wire, 2 m, PUR/PVC	Cd-001	MM08-60ANS-ZUK	1040066
				Connector M8, 3-pin	Cd-002	MM08-60ANS-ZTK	1040068

¹⁾ Sensing range based on installation in non-magnetic material using Magnet MAG-3010-B (M4.0).

MM12

- **Housing:** M12 x 1
- **Housing material:** Nickel-plated brass

Sensing range S_n ¹⁾	Output type	Housing	Output function	Connection	Connection diagram	Model name	Part no.
0 mm ... 60 mm	PNP	Standard	NO	Cable, 3-wire, 2 m, PUR/PVC	Cd-002	MM12-60APS-ZUK	1040069
				Connector M12, 4-pin	Cd-011	MM12-60APS-ZCK	1040070
			NC	Cable, 3-wire, 2 m, PUR/PVC	Cd-003	MM12-60APO-ZUK	1040065
	NPN	Standard	NO	Cable, 3-wire, 2 m, PUR/PVC	Cd-002	MM12-60ANS-ZUK	1040026
				Connector M12, 4-pin	Cd-011	MM12-60ANS-ZCK	1040071
			PNP	Advanced	NO	Cable, 3-wire, 2 m, PUR/PVC	Cd-001
Connector M12, 4-pin	Cd-011	MM12-90APS-ZC0				1029950	
5 mm ... 90 mm	NPN	Advanced	NO	Cable, 3-wire, 2 m, PUR/PVC	Cd-001	MM12-90ANS-ZU0	1051013

¹⁾ Sensing range based on installation in non-magnetic material using Magnet MAG-3010-B (M4.0).

MM18

- Housing: M18 x 1

Sensing range ¹⁾	Output type	Housing	Output function	Connection	Housing material	Connection diagram	Model name	Part no.		
0 mm ... 70 mm	PNP	Standard	NO	Cable, 3-wire, 2 m, PUR/PVC	Nickel-plated brass	Cd-001	MM18-70APS-ZUK	1040029		
				Connector M12, 4-pin	V4A	Cd-011	MM18-70APS-VCK	1050765		
					NC	Connector M12, 4-pin	Nickel-plated brass	Cd-011	MM18-70APS-ZCK	1040072
						Connector M12, 4-pin	Nickel-plated brass	Cd-031	MM18-70APO-ZCK	1047255
			Standard	NO	Cable, 3-wire, 2 m, PUR/PVC	Nickel-plated brass	Cd-001	MM18-70ANS-ZUK	1040085	
					Connector M12, 4-pin	Nickel-plated brass	Cd-011	MM18-70ANS-ZCK	1040073	
5 mm ... 120 mm	PNP	Advanced	NO	Cable, 3-wire, 2 m, PUR/PVC	Nickel-plated brass	Cd-001	MM18-00APS-ZUO	1029952		
				Connector M12, 4-pin	Nickel-plated brass	Cd-011	MM18-00APS-ZCO	1029861		

¹⁾ Sensing range based on installation in non-magnetic material using Magnet MAG-3010-B (M4.0).

Dimensional drawings

MM08-60Axx-xTx,
M8, connector

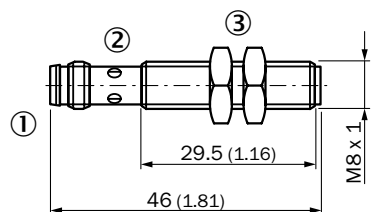

All dimensions in mm (inch)

- ① Connection
- ② LED indicator
- ③ Fastening nuts (2 x); width across 13, plastic

MM08-60APS-xUx,
M8, cable

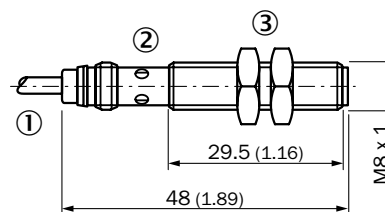

All dimensions in mm (inch)

- ① Connection
- ② LED indicator
- ③ Fastening nuts (2 x); width across 13, plastic

MM12-60Axx-xUK,
M12, Sn = 60 mm, cable

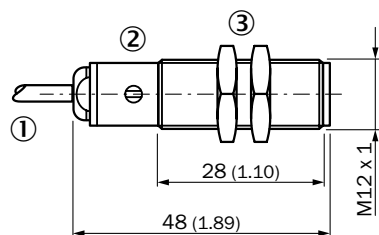

All dimensions in mm (inch)

- ① Connection
- ② LED indicator
- ③ Fastening nuts (2 x); width across 17, metal

MM12-60Axx-xCK,
M12, Sn = 60 mm, connector

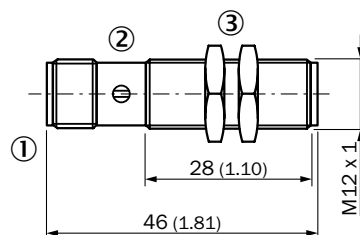

All dimensions in mm (inch)

- ① Connection
- ② LED indicator
- ③ Fastening nuts (2 x); width across 17, metal

MM12-90Axx-xC0,
M12, Sn = 90 mm, connector

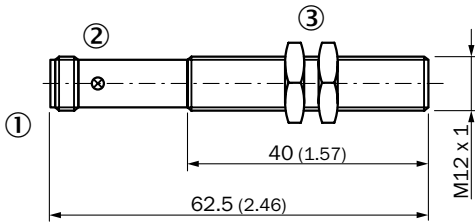

All dimensions in mm (inch)

- ① Connection
- ② LED indicator
- ③ Fastening nuts (2 x); width across 17, metal

MM12-90Axx-xU0,
M12, Sn = 90 mm, cable

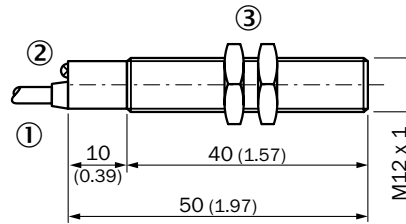

All dimensions in mm (inch)

- ① Connection
- ② LED indicator
- ③ Fastening nuts (2 x); width across 17, metal

MM18-70Axx-xCK,
M18, Sn = 70 mm, connector

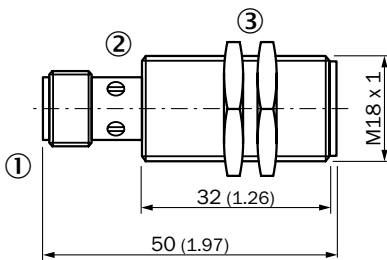

All dimensions in mm (inch)

- ① Connection
- ② LED indicator
- ③ Fastening nuts (2 x); width across 17, metal

MM18-70Axx-xUK,
M18, Sn = 70 mm, cable

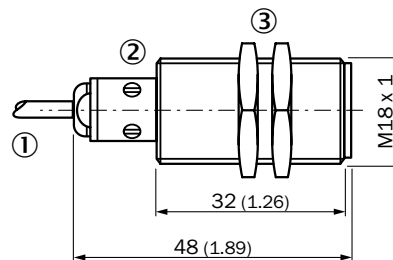

All dimensions in mm (inch)

- ① Connection
- ② LED indicator
- ③ Fastening nuts (2 x); 24 mm hex, metal

E

MM18-00Axx-xC0,
M18, Sn = 120 mm, connector

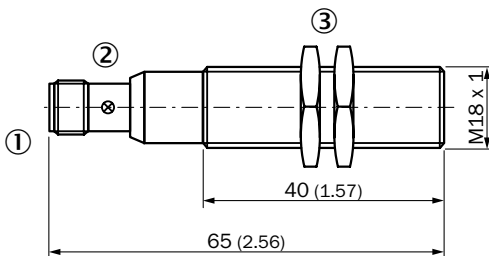

All dimensions in mm (inch)

- ① Connection
- ② LED indicator
- ③ Fastening nuts (2 x); width across 17, metal

MM18-00Axx-xU0,
M18, Sn = 120 mm, cable

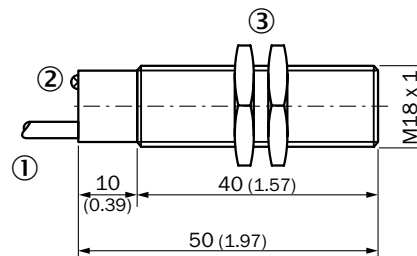

All dimensions in mm (inch)

- ① Connection
- ② LED indicator
- ③ Fastening nuts (2 x); width across 17, metal

Connection diagram

Cd-001

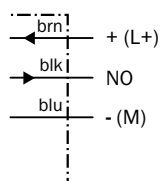

Cd-002

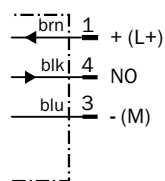

Cd-003

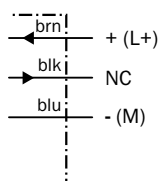

Cd-011

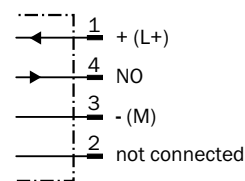

Cd-031

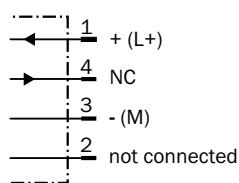

Maximum sensing range

MMxx-60Axx-xxx, S_n = 60 mm

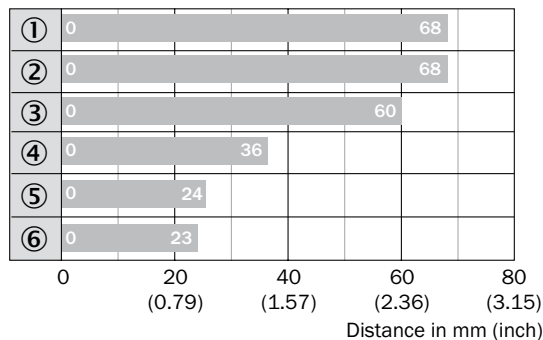

■ Max. sensing range S_n, flush or non-flush installation, non-magnetizable material

Magnet type

Magnet type	Part no.
① MAG-3315-B (M 5.1)	7902086
② MAG-3015-B (M 5.0)	7901786
③ MAG-3010-B (M 4.0)	7901785
④ MAG-2006-B (M 3.0)	7901784
⑤ MAG-0625-A (M 2.0)	7901783
⑥ MAG-1003-S (M 1.0)	7901782

MMxx-90Axx-xxx, S_n = 90 mm

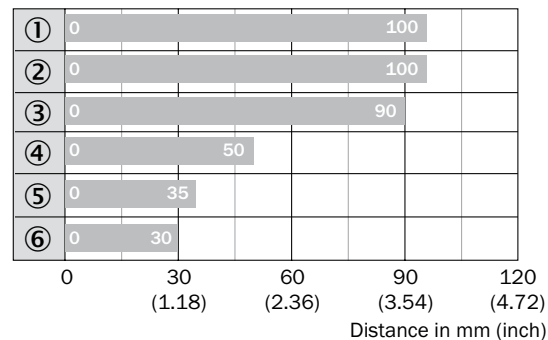

■ Max. sensing range S_n, flush or non-flush installation, non-magnetizable material

Magnet type

Magnet type	Part no.
① MAG-3315-B (M 5.1)	7902086
② MAG-3015-B (M 5.0)	7901786
③ MAG-3010-B (M 4.0)	7901785
④ MAG-2006-B (M 3.0)	7901784
⑤ MAG-0625-A (M 2.0)	7901783
⑥ MAG-1003-S (M 1.0)	7901782

MMxx-70Axx-xxx,
Sn = 70 mm

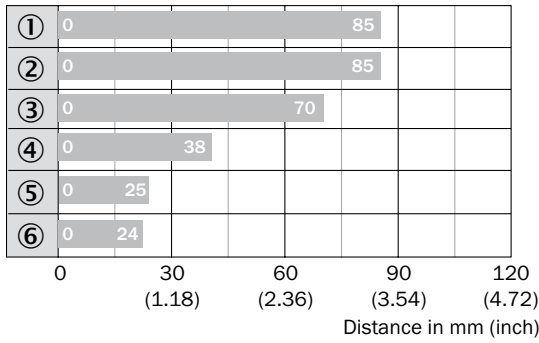

■ Max. sensing range S_n, flush or non-flush installation, non-magnetizable material

MMxx-00Axx-xxx,
Sn = 120 mm

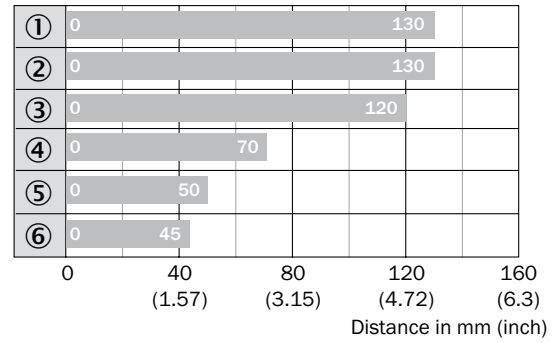

■ Max. sensing range S_n, flush or non-flush installation, non-magnetizable material







Magnet type	Part no.
① MAG-3315-B (M 5.1)	7902086
② MAG-3015-B (M 5.0)	7901786
③ MAG-3010-B (M 4.0)	7901785
④ MAG-2006-B (M 3.0)	7901784
⑤ MAG-0625-A (M 2.0)	7901783
⑥ MAG-1003-S (M 1.0)	7901782

Magnet type	Part no.
① MAG-3315-B (M 5.1)	7902086
② MAG-3015-B (M 5.0)	7901786
③ MAG-3010-B (M 4.0)	7901785
④ MAG-2006-B (M 3.0)	7901784
⑤ MAG-0625-A (M 2.0)	7901783
⑥ MAG-1003-S (M 1.0)	7901782

Recommended accessories

Mounting brackets









- **Accessory type:** Mounting brackets
- **Material:** Steel, zinc coated

Figure	Thread size	Configuration	Model name	Part no.	MM08	MM12	MM18
	M8	Straight	BEF-WG-M08	5321722	●	-	-
		Right angle	BEF-WN-M08	5321721	●	-	-
	M12	Straight	BEF-WG-M12	5321869	-	●	-
		Right angle	BEF-WN-M12	5308447	-	●	-
	M18	Straight	BEF-WG-M18	5321870	-	-	●
		Right angle	BEF-WN-M18	5308446	-	-	●

E

Cordsets and connectors







Connector M12, 4-pin

Figure	Connector type	Configuration	Enclosure rating	Jacket material	Cable length	Model name	Part no.	MM08	MM12	MM18	
	Female connector	Straight	IP 67	PVC	2 m	DOL-1204-G02M	6009382	-	●	●	
5 m					DOL-1204-G05M	6009866	-	●	●		
			IP 68	PUR halogen free	2 m	DOL-1204-G02MC	6025900	-	●	●	
5 m					DOL-1204-G05MC	6025901	-	●	●		
		Right angle	IP 67	PVC	2 m	DOL-1204-W02M	6009383	-	●	●	
5 m					DOL-1204-W05M	6009867	-	●	●		
					IP 68	PUR halogen free	2 m	DOL-1204-W02MC	6025903	-	●
5 m			DOL-1204-W05MC	6025904			-	●	●		
			Straight	IP 67			PBT	-	DOS-1204-G	6007302	-
					Right angle	PBT		-	DOS-1204-W	6007303	-
		Male connector	Straight	IP 67			PBT	-	STE-1204-G	6009932	-
					Right angle	PBT		-	STE-1204-W	6022084	-

Connector M8, 3-pin

- Enclosure rating: IP 67









E

Figure	Connector type	Configuration	Jacket material	Cable length	Model name	Part no.	MM08	MM12	MM18		
	Female connector	Straight	PVC	2 m	DOL-0803-G02M	6010785	●	-	-		
5 m				DOL-0803-G05M	6022009	●	-	-			
			PUR halogen free	2 m	DOL-0803-G02MC	6025888	●	-	-		
5 m				DOL-0803-G05MC	6025889	●	-	-			
		Right angle	IP 67	PVC	2 m	DOL-0803-W02M	6008489	●	-	-	
5 m					DOL-0803-W05M	6022010	●	-	-		
					IP 68	PUR halogen free	2 m	DOL-0803-W02MC	6025891	●	-
5 m			DOL-0803-W05MC	6025892			●	-	-		
			Straight	IP 67			PBT	-	DOS-0803-G	7902077	●
					Right angle	PBT		-	DOS-0803-W	7902078	●

Magnets

Figure	Diameter	Height	Material	Model name	Part no.	MM08	MM12	MM18
	36 mm	19.5 mm	Barium ferrite with plastic coating	MAG-3515-B (M 2.0)	7902086	●	●	●
	30 mm	15 mm	Barium ferrite	MAG-3015-B (M 1.0)	7901786	●	●	●
		10 mm	Barium ferrite	MAG-3010-B (M 3.0)	7901785	●	●	●
	20 mm	6.5 mm	Strontium ferrite	MAG-2006-B (M 4.0)	7901784	●	●	●
	6 mm	25 mm	Aluminum-nickel-cobalt	MAG-0625-A (M 5.0)	7901783	●	●	●
	10 mm	3 mm	Samarium-cobalt	MAG-1003-S (M 5.0)	7901782	●	●	●

Terminal and alignment brackets

Figure	Description	Material	Thread size	Model name	Part no.	MM08	MM12	MM18
	Terminal brackets, without fixed stop	Plastic (PA12), glass-fiber reinforced	M8	BEF-KH-M08	2051477	●	-	-
			M12	BEF-KH-M12	2051479	-	●	-
			M18	BEF-KH-M18	2051481	-	-	●
	Terminal brackets, with fixed stop	Plastic (PA12), glass-fiber reinforced	M8	BEF-KHF-M08	2051478	●	-	-
			M12	BEF-KHF-M12	2051480	-	●	-
			M18	BEF-KHF-M18	2051482	-	-	●
	Universal bar clamp systems	Zinc plated steel (sheet), Diecast zinc (clamp)	M12	BEF-KHS-N05	2051611	-	●	-
			M18	BEF-KHS-N06	2051612	-	-	●
		Stainless steel 1.4571 (sheet), Stainless steel 1.4408 (clamp)	M12	BEF-KHS-N05N	2051621	-	●	-
			M18	BEF-KHS-N06N	2051622	-	-	●
		Steel, zinc coated	-	BEF-MS12G-A	4056054	-	●	●
		Stainless steel (1.4571)	-	BEF-MS12G-NA	4058914	-	●	●

E

→ For additional accessories, please see page G-255

Namur magnetic proximity sensors in a cylindrical housing for explosive areas



Product description

MM Namur magnetic proximity sensors provide large operating distances that can reliably detect magnetic objects. Magnetic proximity sensors are resistant to dust, heat and vibration, making them ideal for use in harsh environments –

even highly explosive atmospheres. By using magnetic conductors, these sensors are able to reliably detect objects over greater distances. The Namur design for hazardous areas is available in MM12 and MM18 designs.

At a glance

- Detection of permanent magnets through non-ferromagnetic materials, such as stainless steel, aluminum, plastic or wood
- Namur design for usage in hazardous explosive areas
- Suitable for object detection in high temperature areas due to long sensing ranges
- Fits on to standard M12 and M18 installation

Your benefits

- Namur design ensures safe operation in highly explosive areas
- Non-contact operation ensures resistance to dirt, dust and vibration, increasing sensor life and reducing maintenance costs
- Large operating distances ensure reliable switching, even with target position tolerances
- Non-contact, universal detection through several substances, including plastic containers and pipes and protective PTFE walls



Additional information

Detailed technical data E-237
 Ordering information E-238
 Dimensional drawings E-238
 Connection diagram E-239
 Maximum sensing range E-239
 Recommended accessories E-240

→ www.mysick.com/en/MM_Namur
 For more information, just enter the link or scan the QR code and get direct access to technical data, CAD design models, operating instructions, software, application examples and much more.



E

Detailed technical data

Features

	MM12 Namur	MM18 Namur
Housing	M12 x 1	M18 x 1
Sensing range S_n	5 mm ... 60 mm ¹⁾ / 5 mm ... 90 mm ¹⁾	5 mm ... 70 mm ¹⁾ / 5 mm ... 120 mm ¹⁾
Assured sensing range S_a	48.6 mm / 72.9 mm	56.7 mm / 97.2 mm
Magnetic sensitivity	1 mT / 0.6 mT	0.7 mT / 0.4 mT
Switching frequency	5,000 Hz	
Output type	Namur	
Output function	Control current depending on switching state according to Namur EN 60947-5-6	
Enclosure rating ²⁾	IP 67	
Magnetic alignment	Axial	

¹⁾ Sensing range based on installation in non-magnetic material using Magnet MAG-3010-B (M4.0).

²⁾ According to EN60529.

Mechanical / electrical

	MM12 Namur	MM18 Namur
Supply voltage	5 V DC ... 25 V DC	
Ripple ¹⁾	≤ 5 %	
Time delay before availability	≤ 2 ms	
Hysteresis	1 % ... 10 %	
Repeatability ²⁾	≤ 1 %	
Temperature drift (% of S_r)	± 10 %	
EMC	According to EN 60947-5-2	
Current consumption, sensor is activated	≥ 2.5 mA	
Current consumption, sensor is not activated	≤ 1 mA	
Connection type	Connector M12, 4-pin / Cable, 2 m, PVC ³⁾ / Cable, 0.8 m	Connector M12, 4-pin / Cable, 2 m, PVC ³⁾
Wire-break protection	✓	
Short-circuit protection	✓	
Reverse polarity protection	✓	
Shock/vibration	30 g, 11 ms/10 ... 55 Hz, 1 mm	
Ambient operating temperature	-25 °C ... +75 °C	
Housing material	Metal, Nickel-plated brass	
Tightening torque, max.	≤ 7 Nm	≤ 25 Nm
EC Approval Certificate	TÜV 99 ATEX 1398	
ATEX marking	EX II 2G Ex ia IIC T6 Ta: -20 °C ... 70 °C	
Hazardous area category	2G	
Input voltage U_i max ⁴⁾	16 V	
Input power P_i max. ⁴⁾	100 mW	
Input current I_i max ⁴⁾	30 mA	
Internal capacitance C_i max. ⁴⁾	15 nF	
Internal inductance L_i max. ⁴⁾	35 µH	
Nominal voltage	8.2 V DC	

¹⁾ Of V_s .

²⁾ Von Sr (VS und Ta constant).

³⁾ Do not bend below 0 °C.

⁴⁾ For connection to a separately certified intrinsically safe circuit only.

Ordering information

MM12 Namur

- Housing: M12 x 1
- Output type: Namur

Sensing range S_n ¹⁾	Connection	Connection diagram	Model name	Part no.
5 mm ... 60 mm	Connector M12, 4-pin	Cd-015	MM12-60A-N-ZC0	7900287
	Cable, 2-wire, 2 m, PVC	Cd-012	MM12-60A-N-ZW0	7900286
5 mm ... 90 mm	Cable, 4-wire, 0.8 m	Cd-012	MM12-90A-N-ZUD	1046761

¹⁾ Sensing range based on installation in non-magnetic material using Magnet MAG-3010-B (M4.0).

MM18 Namur

- Housing: M18 x 1
- Output type: Namur

Sensing range S_n ¹⁾	Connection	Connection diagram	Model name	Part no.
5 mm ... 70 mm	Connector M12, 4-pin	Cd-015	MM18-70A-N-ZC0	7900289
	Cable, 2-wire, 2 m, PVC	Cd-012	MM18-70A-N-ZW0	7900288
5 mm ... 120 mm	Connector M12, 4-pin	Cd-015	MM18-00A-N-ZC0	1026614

¹⁾ Sensing range based on installation in non-magnetic material using Magnet MAG-3010-B (M4.0).

Dimensional drawings

MM12-60A-N-xCx,
M12, connector

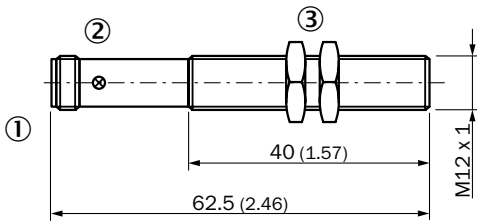

All dimensions in mm (inch)

MM12-60A-N-xUx,
M12, cable

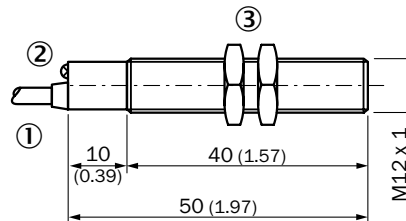

All dimensions in mm (inch)

- ① Connection
- ② LED indicator
- ③ Fastening nuts (2 x); width across 17, metal

- ① Connection
- ② LED indicator
- ③ Fastening nuts (2 x); width across 17, metal

E

**MM18-70A-N-xCx,
M18, connector**

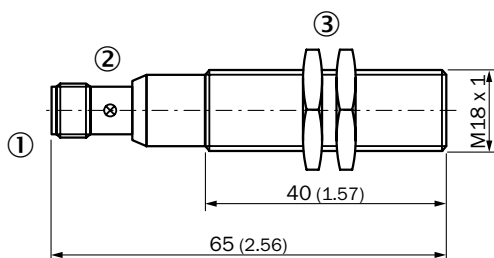

All dimensions in mm (inch)

- ① Connection
- ② LED indicator
- ③ Fastening nuts (2 x); width across 17, metal

**MM18-70A-N-xWx,
M18, cable**

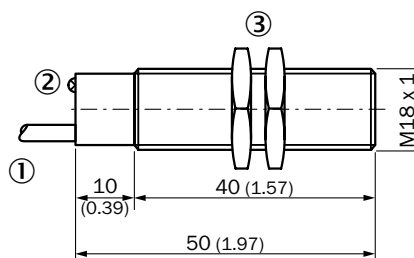

All dimensions in mm (inch)

- ① Connection
- ② LED indicator
- ③ Fastening nuts (2 x); width across 17, metal

Connection diagram

Cd-012

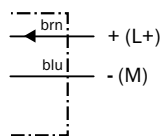

Cd-015

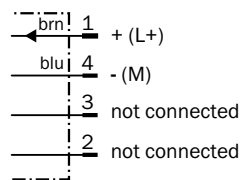

Maximum sensing range

**MMxx-60Axx-xxx,
Sn = 60 mm**

①	0	68			
②	0	68			
③	0	60			
④	0	36			
⑤	0	24			
⑥	0	23			
	0	20	40	60	80
		(0.79)	(1.57)	(2.36)	(3.15)
		Distance in mm (inch)			

■ Max. sensing range S_n , flush or non-flush installation, non-magnetizable material

Magnet type

Magnet type	Part no.
① MAG-3315-B (M 5.1)	7902086
② MAG-3015-B (M 5.0)	7901786
③ MAG-3010-B (M 4.0)	7901785
④ MAG-2006-B (M 3.0)	7901784
⑤ MAG-0625-A (M 2.0)	7901783
⑥ MAG-1003-S (M 1.0)	7901782

**MMxx-90Axx-xxx,
Sn = 90 mm**

①	0	100			
②	0	100			
③	0	90			
④	0	50			
⑤	0	35			
⑥	0	30			
	0	30	60	90	120
		(1.18)	(2.36)	(3.54)	(4.72)
		Distance in mm (inch)			

■ Max. sensing range S_n , flush or non-flush installation, non-magnetizable material

Magnet type

Magnet type	Part no.
① MAG-3315-B (M 5.1)	7902086
② MAG-3015-B (M 5.0)	7901786
③ MAG-3010-B (M 4.0)	7901785
④ MAG-2006-B (M 3.0)	7901784
⑤ MAG-0625-A (M 2.0)	7901783
⑥ MAG-1003-S (M 1.0)	7901782

MMxx-70Axx-xxx,
Sn = 70 mm

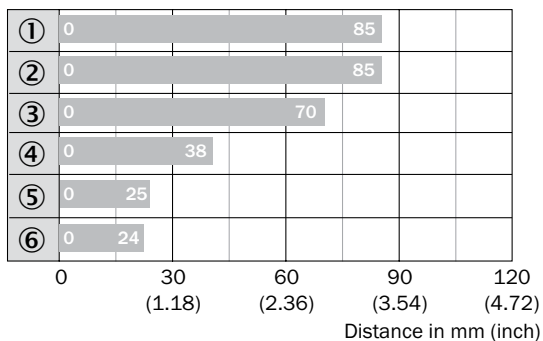

■ Max. sensing range S_n , flush or non-flush installation, non-magnetizable material

MMxx-00Axx-xxx,
Sn = 120 mm

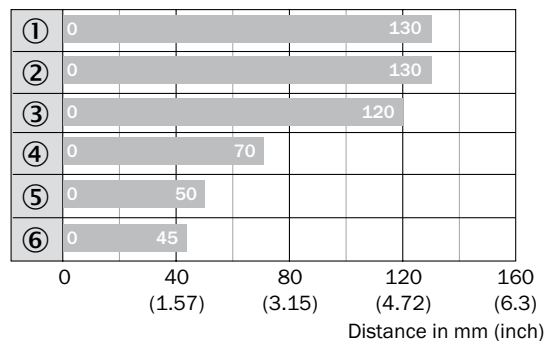

■ Max. sensing range S_n , flush or non-flush installation, non-magnetizable material

Magnet type	Part no.
① MAG-3315-B (M 5.1)	7902086
② MAG-3015-B (M 5.0)	7901786
③ MAG-3010-B (M 4.0)	7901785
④ MAG-2006-B (M 3.0)	7901784
⑤ MAG-0625-A (M 2.0)	7901783
⑥ MAG-1003-S (M 1.0)	7901782

Magnet type	Part no.
① MAG-3315-B (M 5.1)	7902086
② MAG-3015-B (M 5.0)	7901786
③ MAG-3010-B (M 4.0)	7901785
④ MAG-2006-B (M 3.0)	7901784
⑤ MAG-0625-A (M 2.0)	7901783
⑥ MAG-1003-S (M 1.0)	7901782

Recommended accessories

Mounting brackets







- **Accessory type:** Mounting brackets
- **Material:** Steel, zinc coated

E

Figure	Thread size	Configuration	Model name	Part no.	MM12 Namur	MM18 Namur
	M12	Straight	BEF-WG-M12	5321869	●	-
		Right angle	BEF-WN-M12	5308447	●	-
	M18	Straight	BEF-WG-M18	5321870	-	●
		Right angle	BEF-WN-M18	5308446	-	●





Cordsets and connectors

Connector M12, 4-pin



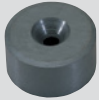



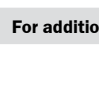

Figure	Connector type	Configuration	Enclosure rating	Jacket material	Cable length	Model name	Part no.	MM12 Namur	MM18 Namur
	Female connector	Straight	IP 67	PVC	2 m	DOL-1204-G02M	6009382	●	●
					5 m	DOL-1204-G05M	6009866	●	●
IP 68			PUR halogen free	2 m	DOL-1204-G02MC	6025900	●	●	
				5 m	DOL-1204-G05MC	6025901	●	●	
		IP 67	PVC	2 m	DOL-1204-W02M	6009383	●	●	
				5 m	DOL-1204-W05M	6009867	●	●	
		IP 68	PUR halogen free	2 m	DOL-1204-W02MC	6025903	●	●	
				5 m	DOL-1204-W05MC	6025904	●	●	
		Straight	IP 67	PBT	-	DOS-1204-G	6007302	●	●
					Right angle	PBT	-	DOS-1204-W	6007303
	Male connector	Straight	IP 67	PBT	-	STE-1204-G	6009932	●	●
					Right angle	PBT	-	STE-1204-W	6022084



Magnets

Figure	Diameter	Height	Material	Model name	Part no.	MM12 Namur	MM18 Namur
	36 mm	19.5 mm	Barium ferrite with plastic coating	MAG-3515-B (M 2.0)	7902086	●	●
	30 mm	15 mm	Barium ferrite	MAG-3015-B (M 1.0)	7901786	●	●
		10 mm	Barium ferrite	MAG-3010-B (M 3.0)	7901785	●	●
	20 mm	6.5 mm	Strontium ferrite	MAG-2006-B (M 4.0)	7901784	●	●
	6 mm	25 mm	Aluminum-nickel-cobalt	MAG-0625-A (M 5.0)	7901783	●	●
	10 mm	3 mm	Samarium-cobalt	MAG-1003-S (M 5.0)	7901782	●	●

Terminal and alignment brackets

Figure	Description	Material	Thread size	Model name	Part no.	MM12	MM18
	Terminal brackets, without fixed stop	Plastic (PA12), glass-fiber reinforced	M12	BEF-KH-M12	2051479	●	-
			M18	BEF-KH-M18	2051481	-	●
	Terminal brackets, with fixed stop	Plastic (PA12), glass-fiber reinforced	M12	BEF-KHF-M12	2051480	●	-
			M18	BEF-KHF-M18	2051482	-	●
	Plate for universal bar clamp	Zinc plated steel (sheet), diecast zinc (clamp)	M12	BEF-KHS-N05	2051611	●	-
			M18	BEF-KHS-N06	2051612	-	●
		Stainless steel 1.4571 (sheet), Stainless steel 1.4408 (clamp)	M12	BEF-KHS-N05N	2051621	●	-
			M18	BEF-KHS-N06N	2051622	-	●
	Mounting rod, straight	Steel, zinc coated	-	BEF-MS12G-A	4056054	●	●
		Stainless steel (1.4571)	-	BEF-MS12G-NA	4058914	●	●

→ For additional accessories, please see page G-255

E



Magnetic proximity sensors in a rectangular housing

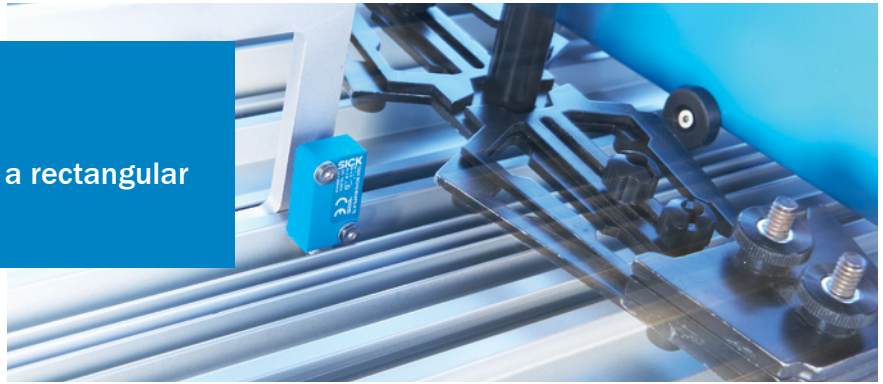

Product description

MQ magnetic proximity sensors reliably detect permanent magnets through non-ferromagnetic materials such as stainless steel, aluminum, plastic or wood. The MQ series features a square, com-

compact plastic housing that makes it easy to install. These sensors are resistant to dust, heat and vibration, making them ideal for use in harsh environments.

At a glance

- Long sensing distance in a small, compact rectangular plastic housing with an IP 67 enclosure rating
- Detection of permanent magnets through non-ferromagnetic materials such as stainless steel, aluminum, plastic, or wood
- Solves high-temperature applications by installing the temperature-resistant magnet in the high-temperature area and the sensor behind an insulated area
- Non-contact operation that is resistant to dust, dirt, shock and vibration
- Precise switching point and hysteresis
- Sensing distance up to 60 mm
- High switching frequency
- Short-circuit, reverse polarity protection and power-up pulse suppression

Your benefits

- Non-contact operation eliminates interference from dirt, dust, shock and vibrations, reducing maintenance costs
- Long sensing distance with reliable switching reduces miscounts and increases machine throughput
- Easy to install, low-cost sensor solution saves installation time and costs
- Compact plastic housing saves machine space



Additional information

Detailed technical data	E-245
Ordering information	E-246
Dimensional drawings	E-246
Connection diagram	E-246
Maximum sensing range	E-247
Recommended accessories	E-247

→ www.mysick.com/en/MQ

For more information, just enter the link or scan the QR code and get direct access to technical data, CAD design models, operating instructions, software, application examples and much more.



Detailed technical data

Features

Dimensions (W x H x D)	10.3 mm x 37 mm x 16 mm / 10.3 mm x 28 mm x 16 mm
Housing	Rectangular
Sensing range S_n ¹⁾	5 mm ... 60 mm
Assured sensing range S_a	48.6 mm
Magnetic sensitivity	1 mT
Switching frequency	5,000 Hz
Output type	NPN / PNP
Output function	NO
Electrical wiring	DC 3-wire
Enclosure rating ²⁾	IP 67
Magnetic alignment	Axial

¹⁾ Sensing range based on installation in non-magnetic material using Magnet MAG-3010-B (M4.0).

²⁾ According to EN60529.

Mechanical / electrical

Supply voltage	10 V DC ... 30 V DC
Ripple ¹⁾	≤ 10 %
Voltage drop ²⁾	≤ 1.5 V
Current consumption ³⁾	≤ 5 mA
Time delay before availability	≤ 2 ms
Hysteresis	1 % ... 10 %
Repeatability ⁴⁾	≤ 1 %
Temperature drift (% of S_p)	± 10 %
EMC	According to EN 60947-5-2
Output current I_a	≤ 300 mA
Connection type	Connector M8, 3-pin / Cable, 2 m, PUR/PVC ⁵⁾ / Cable with connector M8, 4-pin
Short-circuit protection ⁶⁾	✓
Reverse polarity protection	✓
Power-up pulse protection	✓
Shock/vibration	30 g, 11 ms/10 ... 55 Hz, 1 mm
Ambient operating temperature	-25 °C ... +75 °C
Housing material	Polyamid (PA)
Housing cap material	Polyamid (PA)

¹⁾ Of V_s .

²⁾ At I_a max.

³⁾ Without load.

⁴⁾ Von Sr (VS und Ta constant).

⁵⁾ Do not bend below 0 °C.

⁶⁾ Pulsed.

Ordering information

- Output function: NO

Sensing range S_{11} ¹⁾	Output type	Connection	Connection diagram	Model name	Part no.
5 mm ... 60 mm	NPN	Connector M8, 3-pin	Cd-002	MQ10-60ANS-KT0	7900281
		Cable, 3-wire, 2 m, PUR/PVC	Cd-001	MQ10-60ANS-KU0	7900279
	PNP	Connector M8, 3-pin	Cd-002	MQ10-60APS-KT0	7900280
		Cable, 3-wire, 2 m, PUR/PVC	Cd-001	MQ10-60APS-KU0	7900278
		Cable with connector M8, 4-pin	Cd-011	MQ10-60APS-KP0	1017405

¹⁾ Sensing range based on installation in non-magnetic material using Magnet MAG-3010-B (M4.0).

Dimensional drawings

MQ10-60Axx-xTx, connector

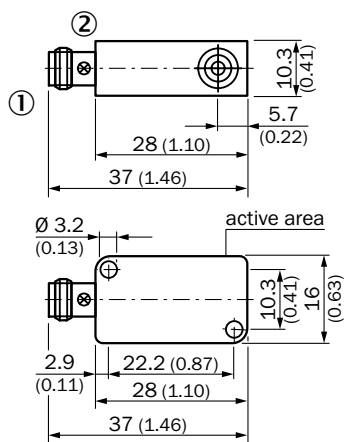

All dimensions in mm (inch)

- ① Connection
- ② LED indicator

MQ10-60Axx-xUx, MQ10-60Axx-xPx, cable, cable with connector

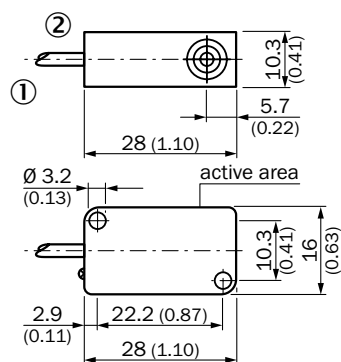

All dimensions in mm (inch)

- ① Connection
- ② LED indicator

E

Connection diagram

Cd-001

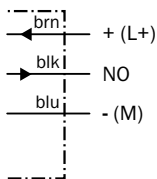

Cd-002

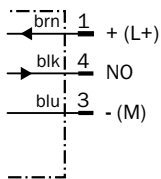

Cd-011

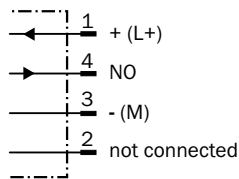

Maximum sensing range

MMxx-60Axx-xxx

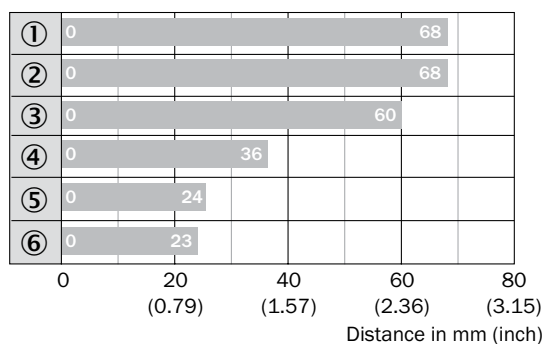

■ Max. sensing range S_n, flush or non-flush installation, non-magnetizable material

Magnet type	Part no.
① MAG-3315-B (M 5.1)	7902086
② MAG-3015-B (M 5.0)	7901786
③ MAG-3010-B (M 4.0)	7901785
④ MAG-2006-B (M 3.0)	7901784
⑤ MAG-0625-A (M 2.0)	7901783
⑥ MAG-1003-S (M 1.0)	7901782

Recommended accessories





Cordsets and connectors

Connector M8, 3-pin

- Enclosure rating: IP 67

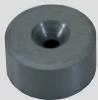
Figure	Connector type	Configuration	Jacket material	Cable length	Model name	Part no.
	Female connector	Straight	PVC	2 m	DOL-0803-G02M	6010785
				5 m	DOL-0803-G05M	6022009
PUR halogen free			2 m	DOL-0803-G02MC	6025888	
			5 m	DOL-0803-G05MC	6025889	
		Right angle	PVC	2 m	DOL-0803-W02M	6008489
				5 m	DOL-0803-W05M	6022010
		Right angle	PUR halogen free	2 m	DOL-0803-W02MC	6025891
				5 m	DOL-0803-W05MC	6025892
		Straight	PBT	-	DOS-0803-G	7902077
		Right angle	PBT	-	DOS-0803-W	7902078

Magnets

Figure	Diameter	Height	Material	Model name	Part no.
	36 mm	19.5 mm	Barium ferrite with plastic coating	MAG-3515-B (M 2.0)	7902086
	30 mm	15 mm	Barium ferrite	MAG-3015-B (M 1.0)	7901786
		10 mm	Barium ferrite	MAG-3010-B (M 3.0)	7901785
	20 mm	6.5 mm	Strontium ferrite	MAG-2006-B (M 4.0)	7901784
	6 mm	25 mm	Aluminum-nickel-cobalt	MAG-0625-A (M 5.0)	7901783
	10 mm	3 mm	Samarium-cobalt	MAG-1003-S (M 5.0)	7901782

→ For additional accessories, please see page G-255

Your order, please! Customizable solutions to fit your needs.

If you don't find the proximity sensor in the SICK portfolio that meets your requirements, we can develop a sensor based on your specifications that fits your application.



Even with a wide range of standard offerings for proximity sensors, individual and customized solutions are sometimes required to meet the specific requirements and application conditions in the automation industry. The dialog with our specialists for customized development begins here.

Whether small, but crucial adaptations to our standard components or comprehensive developments are required, our experts will find the optimal solution. We guarantee a structured project workflow from the start.



Tailored solutions

Design to implementation of a tailored solution is divided into three areas and six phases. During each phase of the project, you can rely on our support and expertise – anywhere in the world.



F

Customizable solutions to fit your needs

SICK is on your side as an innovative, reliable and competent partner in evaluating and assessing all application requirements. After determining the necessary the necessary product adjustments, we define the specification for your customized solution in collaboration with you.

Compile your “wish list” from the following components:

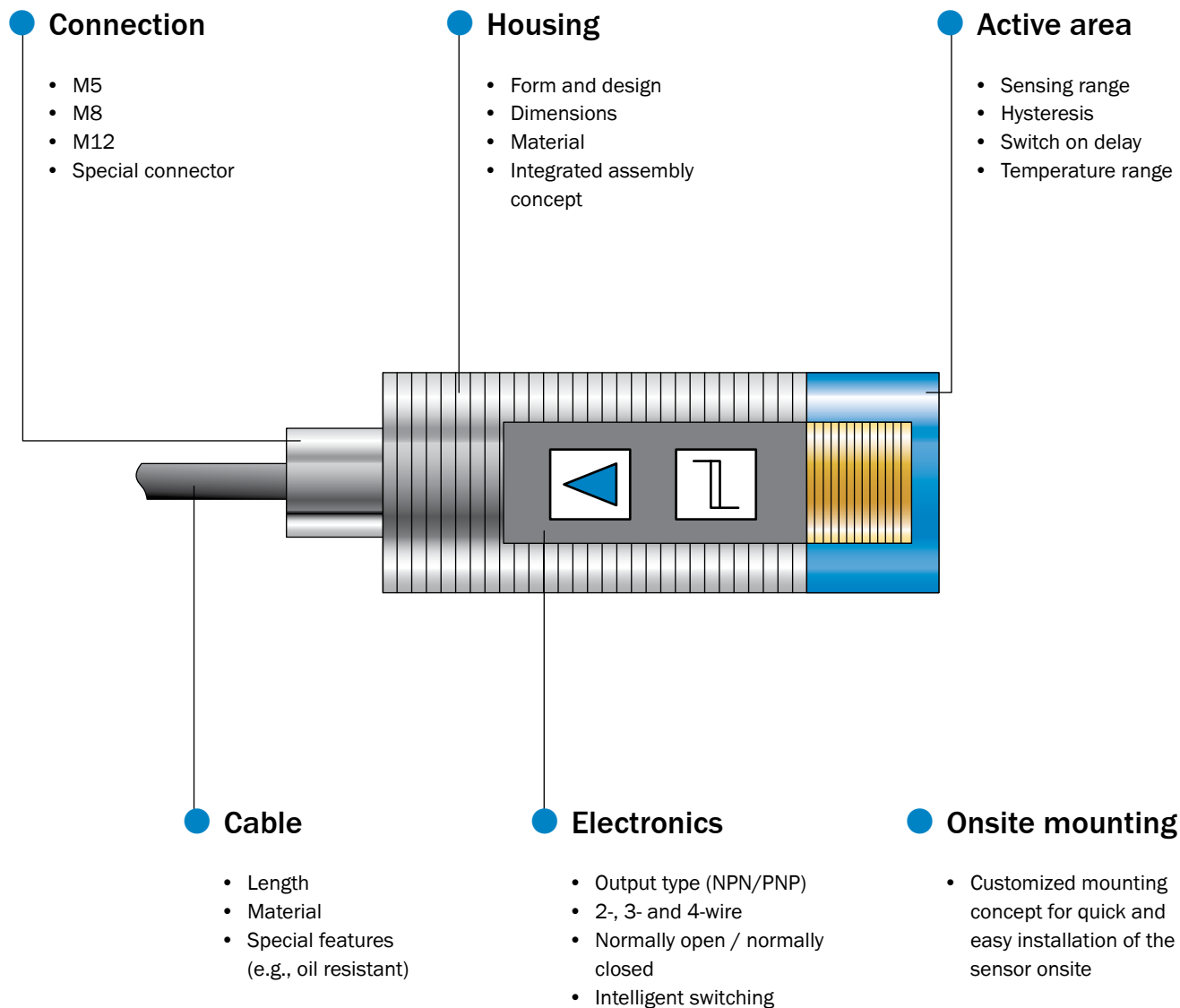

F



Your contacts at SICK are happy to advise you.





Perfect sensor integration made easy

Innovative sensor technology is only one side of the coin when talking about intelligent automation solutions. The picture is completed by matching accessories for professional and cost-effective integration.

Whether electrical connection technology or mechanical mounting systems, only the right integrative system products lead to a high quality, highly available application solution. The advantage? Sensors and accessories work in conjunction to offer maximum operational safety.

In addition, the user is able to save additional costs for development, manufacture and procurement. A wide range of accessory components are always available on short-notice – convenient single-source availability in combination with sensors. And in the event that a custom solution is required, SICK is on your side as a reliable and competent partner. Tailored developments and adaptations can be implemented in just a short period of time.



Accessories from SICK – the solution for reliable sensor integration.



Accessories

General informationG-256
Mounting systemsG-258
MagnetsG-266
Connection systemsG-267
Intrinsically safe Namur amplifierG-280



Mounting systems



Product description

To integrate SICK sensors perfectly into a machine or system, mounting equipment tailored precisely to the sensors is required. Whether fine adjustment to precision equipment or protection against environmental conditions such as those in the lumber industry, SICK provides matching designs and products for installation, alignment and protection for its sensors. Customer- and system-specific mounting elements can also be developed and delivered together with the sensor for special applications in close collaboration with the customer.

Your benefits

- Fast commissioning and maintenance of systems and machines due to simple, practical sensor mounting
- Optimum alignment of the sensor to the object using the universal bar clamp system
- Prevention of sensor damage and securing of sensor functionality with the aid of SICK sensor protection solutions
- Enhanced system availability

At a glance

- Mounting systems designed for SICK sensors
- A wide range of mounting brackets and plates to choose from for easy sensor mounting
- Flexible sensor alignment specific to the application with the SICK universal clamp system
- Protective devices shield sensors from mechanical stresses or protect from weather, which could impair the functioning of the sensors
- Application-specific solutions available for sensor mounting, alignment or protection



Passive connection technology



Product description

A wide range of terminal screwed male and female connectors allows the user to implement their own customized wiring solutions. Different lengths and qualities of cable can be combined to suit the application, quickly and smoothly. Connecting cables, having a molded round connector on one end and the other end open, offer maximum flexibility to wire sensors.

Your benefits

- Operational safety because the connection systems are designed for the sensors
- High quality components with long service life helps reduce costs
- Reliable signal transmission is critical to high productivity

At a glance

- Terminal screwed connectors with screw connection or push-in connection (M8 right angle)
- Connecting and extension cables with PUR jacket for flexible and demanding areas of application and in drag chains. Very high resistance to oils, lubricants and coolants.
- Connecting and extension cables with PVC jacket for use with medium mechanical stresses in dry zones, such as assembly lines, packaging and material handling.

The cable jacket features good resistance to chemicals, where in contrast PVC has only limited resistance to lubricants and coolants.







- Connecting and extension cables of the IP 69K series are especially suitable for use in the food and beverage industry due to their high resistance to chemicals, acids, alkalis and cleaning agents.



Mounting systems

Mounting brackets

- For all proximity sensors with metric housing

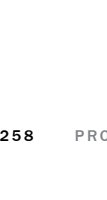
Figure	Accessory type	Material	Model name	Part no.	M8	M12	M18	M30
	Mounting brackets, straight	Steel, zinc coated	BEF-WG-M08	5321722	●	-	-	-
		Steel, zinc coated	BEF-WG-M12	5321869	-	●	-	-
		Stainless steel	BEF-WG-M12N	5320950	-	●	-	-
		Steel, zinc coated	BEF-WG-M18	5321870	-	-	●	-
		Stainless steel	BEF-WG-M18N	5320948	-	-	●	-
		Steel, zinc coated	BEF-WG-M30	5321871	-	-	-	●
	Mounting brackets, right angled	Steel, zinc coated	BEF-WN-M08	5321721	●	-	-	-
		Steel, zinc coated	BEF-WN-M12	5308447	-	●	-	-
		Stainless steel	BEF-WN-M12N	5320949	-	●	-	-
		Steel, zinc coated	BEF-WN-M18	5308446	-	-	●	-
		Stainless steel	BEF-WN-M18N	5320947	-	-	●	-
		Steel, zinc coated	BEF-WN-M30	5308445	-	-	-	●



Mounting bracket dimensional drawings

BEF-WG-M08

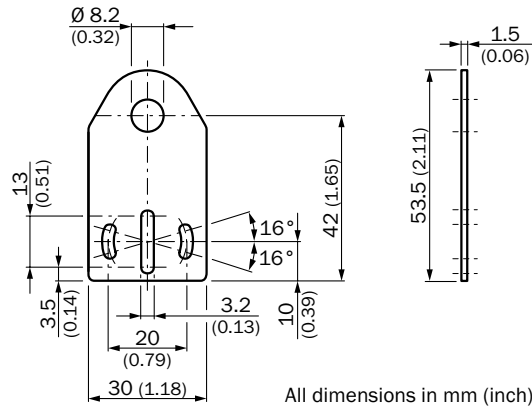

BEF-WG-M12(N)

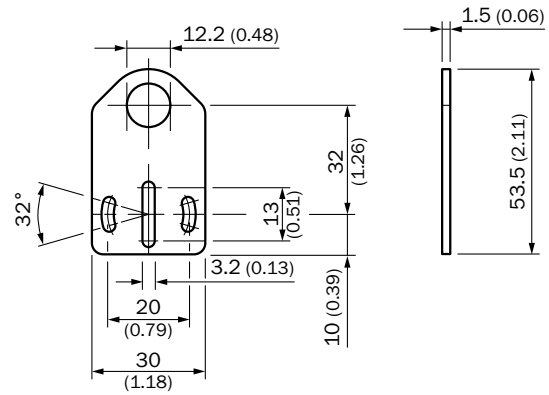

BEF-WG-M18(N)

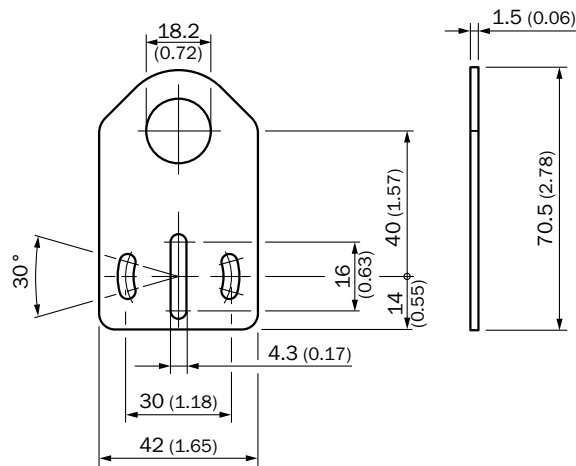

BEF-WG-M30

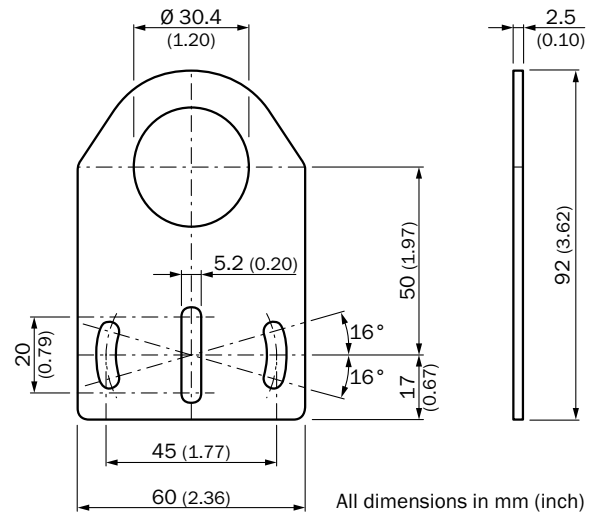

BEF-WN-M08

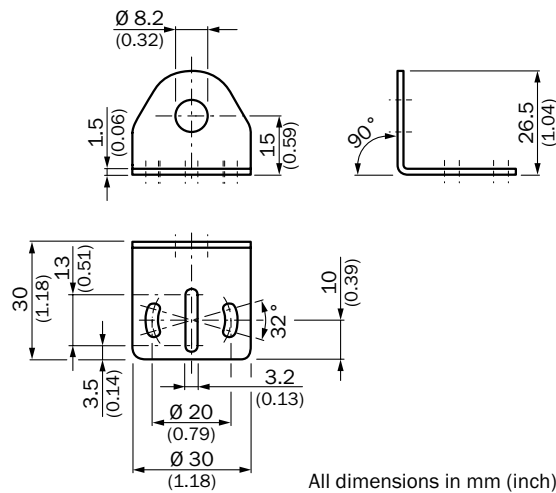

BEF-WN-M12(N)

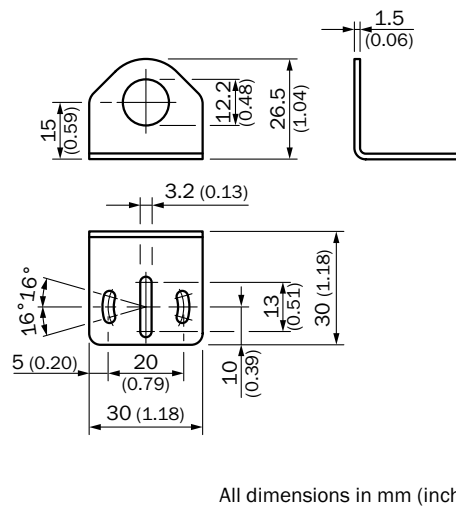

BEF-WN-M18(N)

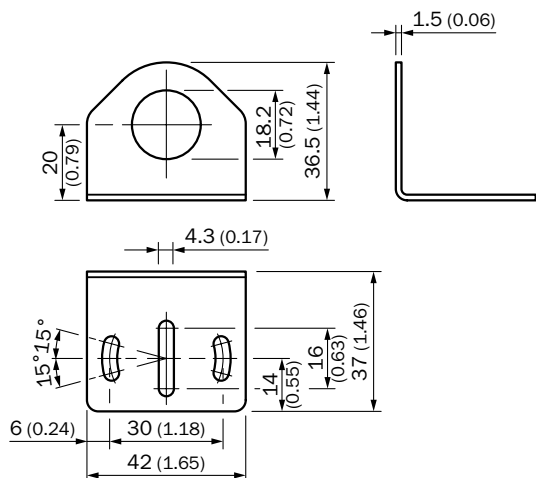

All dimensions in mm (inch)

BEF-WN-M30

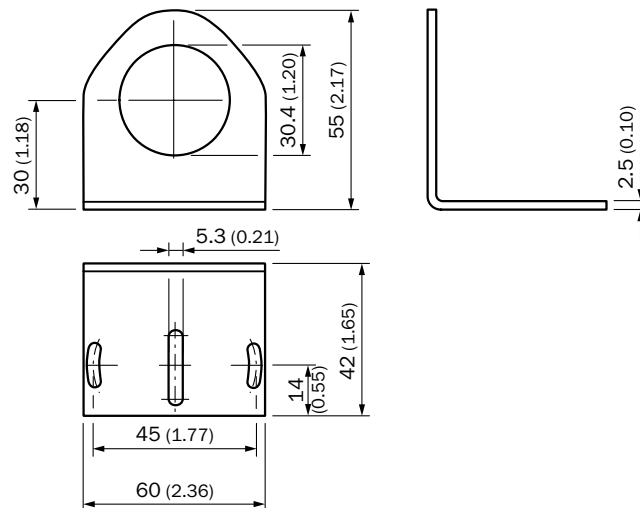

All dimensions in mm (inch)

Terminal and alignment brackets

- For all proximity sensors with metric housing

Figure	Accessory type	Description	Material	Model name	Part no.	M8	M12	M18	M30
	Terminal brackets	Without fixed stop	Plastic (PA12), glass-fiber reinforced	BEF-KH-M08	2051477	●	-	-	-
		With fixed stop		BEF-KHF-M08	2051478	●	-	-	-
		Without fixed stop		BEF-KH-M12	2051479	-	●	-	-
		With fixed stop		BEF-KHF-M12	2051480	-	●	-	-
		Without fixed stop		BEF-KH-M18	2051481	-	-	●	-
		With fixed stop		BEF-KHF-M18	2051482	-	-	●	-
	Alignment brackets	With ball joint	Plastic	BEF-WN-M18-ST02	5312973	-	-	●	-
		Mounting adapter for silo and tank applications	Plastic (POM)	BEF-EA-CM30	2043770	-	-	-	●



Terminal and alignment dimensional drawings

BEF-KH-M08

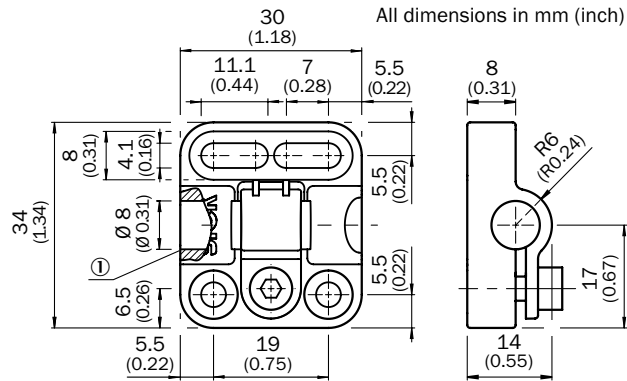

① Without fixed stop

BEF-KHF-M08

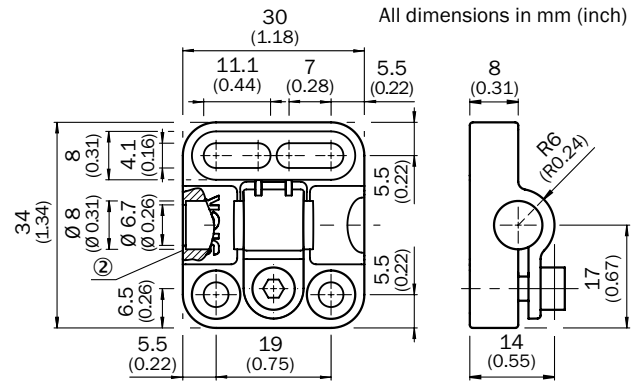

① With fixed stop

BEF-KH-M12

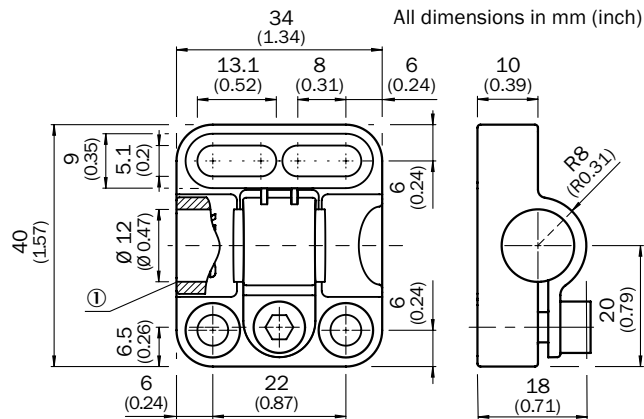

① Without fixed stop

BEF-KHF-M12

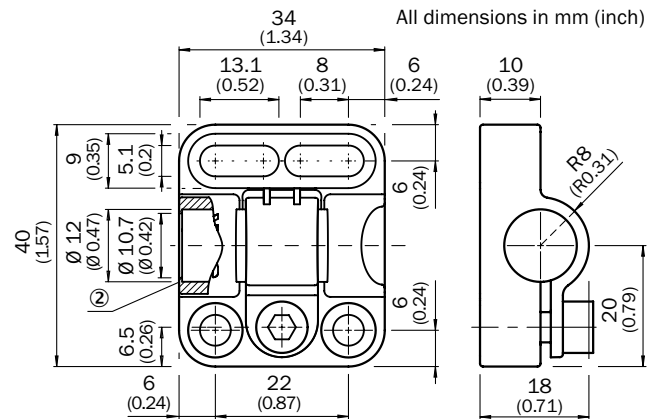

① With fixed stop

BEF-KH-M18

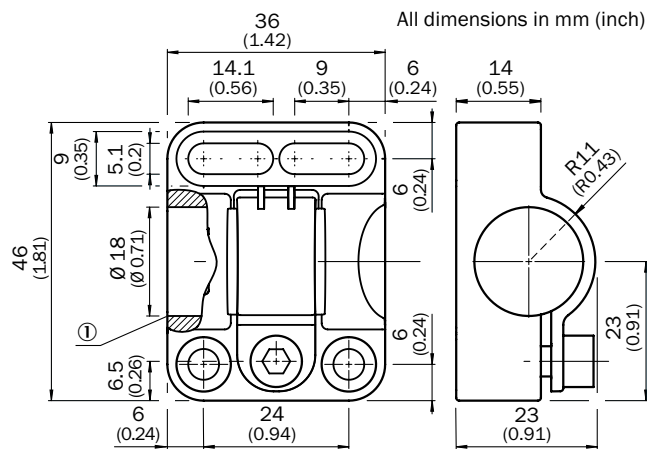

① Without fixed stop

BEF-KHF-M18

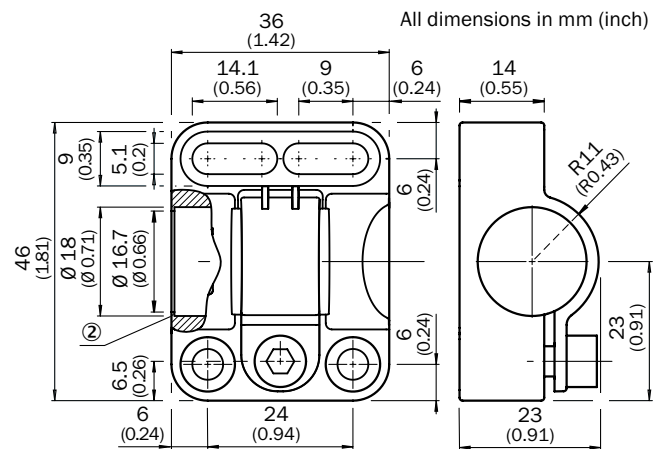

② With fixed stop



BEF-WN-M18-ST02

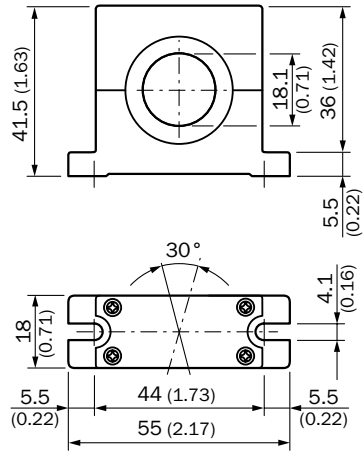

All dimensions in mm (inch)

BEF-EA-CM30

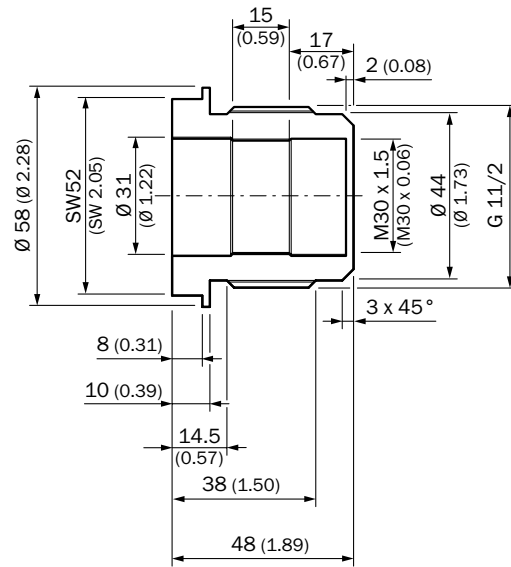











All dimensions in mm (inch)



Universal bar clamp systems

- For all proximity sensors with metric housing

Figure	Accessory type	Description	Material	Model name	Part no.	M8	M12	M18	M30
		Universal bar clamp	Zinc plated steel	BEF-KHS-KH3	5322626	●	●	●	●
			Stainless steel 1.4301	BEF-KHS-KH3N	5322627	●	●	●	●
		Right angle bracket for bar clamp	Zinc plated steel (sheet), Diecast zinc (clamp)	BEF-KHS-N05	2051611	-	●	-	-
			Stainless steel 1.4571 (sheet), Stainless steel 1.4408 (clamp)	BEF-KHS-N05N	2051621	-	●	-	-
		Right angle bracket for bar clamp	Zinc plated steel (sheet), Diecast zinc (clamp)	BEF-KHS-N06	2051612	-	-	●	-
			Stainless steel 1.4571 (sheet), Stainless steel 1.4408 (clamp)	BEF-KHS-N06N	2051622	-	-	●	-
		Right angle bracket for bar clamp	Zinc plated steel (sheet), Diecast zinc (clamp)	BEF-KHS-N10	2062372	-	-	-	●
			Stainless steel 1.4571 (sheet), Stainless steel 1.4408 (clamp)	BEF-KHS-N10N	2062373	-	-	-	●
	Universal bar clamp systems	Mounting bar, straight, 200 mm	Steel, zinc coated	BEF-MS12G-A	4056054	●	●	●	●
			Stainless steel (1.4571)	BEF-MS12G-NA	4058914	●	●	●	●
		Mounting bar, straight, 300 mm	Steel, zinc coated	BEF-MS12G-B	4056055	●	●	●	●
			Stainless steel (1.4571)	BEF-MS12G-NB	4058915	●	●	●	●
		Mounting bar, L-shape, 150 mm / 150mm	Steel, zinc coated	BEF-MS12L-A	4056052	●	●	●	●
			Stainless steel (1.4571)	BEF-MS12L-NA	4058912	●	●	●	●
		Mounting bar, L-shape, 250 mm / 250mm	Steel, zinc coated	BEF-MS12L-B	4056053	●	●	●	●
			Stainless steel (1.4571)	BEF-MS12L-NB	4058913	●	●	●	●
		Mounting bar, Z-shape, 150 mm / 70mm / 150 mm	Steel, zinc coated	BEF-MS12Z-A	4056056	●	●	●	●
			Stainless steel (1.4571)	BEF-MS12Z-NA	4058916	●	●	●	●
		Mounting bar, Z-shape, 150 mm / 70 mm / 250 mm	Steel, zinc coated	BEF-MS12Z-B	4056057	●	●	●	●
			Stainless steel (1.4571)	BEF-MS12Z-NB	4058917	●	●	●	●
		Bar clamp	Aluminum	BEF-RMC-D12	5321878	●	●	●	●

Universal bar clamp dimensional drawings

BEF-KHS-KH3(N)

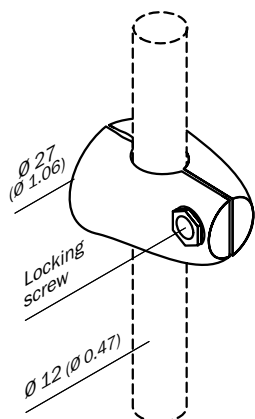

All dimensions in mm (inch)

BEF-KHS-N05(N)

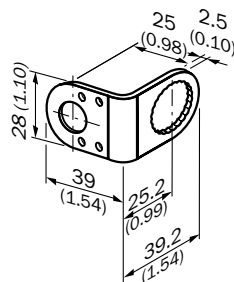

All dimensions in mm (inch)

BEF-KHS-N06(N)

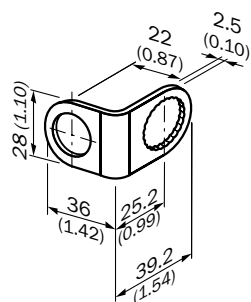

All dimensions in mm (inch)

BEF-MS12G-(N)A

BEF-MS12G-(N)B

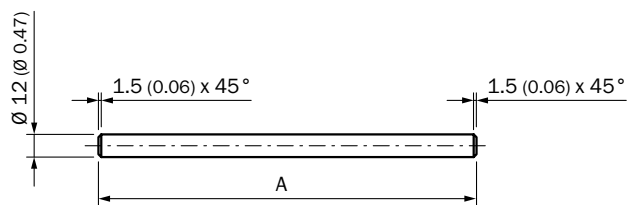

All dimensions in mm (inch)

BEF-MS12G-(N)A: A = 200 mm

BEF-MS12G-(N)B: A = 300 mm

BEF-MS12L-(N)A

BEF-MS12L-(N)B

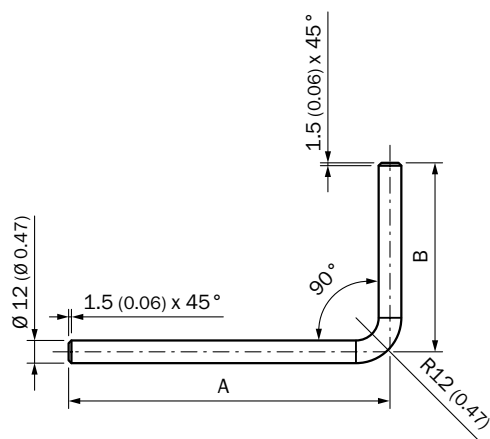

All dimensions in mm (inch)

BEF-MS12L-(N)A: A = 200 mm, B = 150 mm

BEF-MS12L-(N)B: A = 250 mm, B = 250 mm

BEF-MS12Z-(N)A

BEF-MS12Z-(N)B

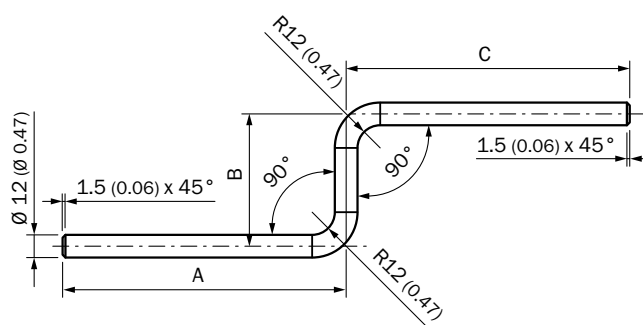

All dimensions in mm (inch)

BEF-MS12Z-(N)A: A = 150 mm, B = 70 mm, C = 150 mm

BEF-MS12Z-(N)B: A = 150 mm, B = 70 mm, C = 250 mm



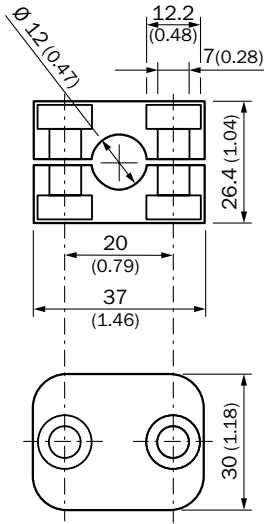



BEF-RMC-D12

All dimensions in mm (inch)

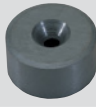
Magnets

- For all magnetic proximity sensors

Figure	Material features	Material	Diameter	Height	Model name	Part no.	MM	MM Namur	MQ
	<ul style="list-style-type: none"> • Low remanence • High coercivity • Maximum temperature: +150 °C • No oxidation 	Barium ferrite with plastic coating	36 mm	19.5 mm	MAG-3515-B (M 2.0)	7902086	●	●	●
		Barium ferrite	30 mm	15 mm	MAG-3015-B (M 1.0)	7901786	●	●	●
				10 mm	MAG-3010-B (M 3.0)	7901785	●	●	●
			Strontium ferrite	20 mm	6.5 mm	MAG-2006-B (M 4.0)	7901784	●	●
	<ul style="list-style-type: none"> • Low remanence • Low coercivity • -270 °C ... +400 °C • Resistant to acids and oxides 	Aluminum-nickel-cobalt	6 mm	25 mm	MAG-0625-A (M 5.0)	7901783	●	●	●
	<ul style="list-style-type: none"> • Very high remanence • Very high coercivity • Maximum temperature: +250 °C 	Samarium-cobalt	10 mm	3 mm	MAG-1003-S (M 5.0)	7901782	●	●	●

Connection systems

Single-ended cordsets

- Female connector and flying leads













Figure	Connector	Configuration	Jacket material	Cable length	Model name	Part no.	Flying leads, 3-wire	Flying leads, 4-wire	Flying leads, 5-wire	
	Female connector M8, 3-pin	Straight	PVC	2 m	DOL-0803-G02M	6010785	●	-	-	
				5 m	DOL-0803-G05M	6022009	●	-	-	
				10 m	DOL-0803-G10M	6022011	●	-	-	
				15 m	DOL-0803-G15M	6036472	●	-	-	
			PUR halogen free	2 m	DOL-0803-G02MC	6025888	●	-	-	
				5 m	DOL-0803-G05MC	6025889	●	-	-	
				10 m	DOL-0803-G10MC	6025890	●	-	-	
					Right angle	PVC	2 m	DOL-0803-W02M	6008489	●
5 m		DOL-0803-W05M	6022010				●	-	-	
10 m		DOL-0803-W10M	6022012				●	-	-	
15 m		DOL-0803-W15M	6036473				●	-	-	
		PUR halogen free	2 m	DOL-0803-W02MC		6025891	●	-	-	
	5 m		DOL-0803-W05MC	6025892		●	-	-		
	10 m		DOL-0803-W10MC	6025893		●	-	-		
			Female connector M8, 4-pin	Straight		PVC	2 m	DOL-0804-G02M	6009870	-
5 m		DOL-0804-G05M			6009872		-	●	-	
10 m		DOL-0804-G10M			6010754		-	●	-	
		PUR halogen free			2 m		DOL-0804-G02MC	6025894	-	●
	5 m				DOL-0804-G05MC	6025895	-	●	-	
	10 m				DOL-0804-G10MC	6025896	-	●	-	
					Right angle	PVC	2 m	DOL-0804-W02M	6009871	-
5 m		DOL-0804-W05M					6009873	-	●	-
10 m		DOL-0804-W10M		6010755			-	●	-	
		PUR halogen free		2 m			DOL-0804-W02MC	6025897	-	●
	5 m			DOL-0804-W05MC		6025898	-	●	-	
	10 m			DOL-0804-W10MC		6025899	-	●	-	
			Female connector M12, 4-pin	Straight		PVC	2 m	DOL-1204-G02M	6009382	-
5 m		DOL-1204-G05M					6009866	-	●	-
10 m		DOL-1204-G10M			6010543		-	●	-	
		PUR halogen free			2 m		DOL-1204-G02MC	6025900	-	●
	5 m				DOL-1204-G05MC	6025901	-	●	-	
	10 m				DOL-1204-G10MC	6025902	-	●	-	
					Right angle	PVC	2 m	DOL-1204-W02M	6009383	-
5 m		DOL-1204-W05M					6009867	-	●	-
10 m		DOL-1204-W10M		6010541			-	●	-	
		PUR halogen free		2 m			DOL-1204-W02MC	6025903	-	●
	5 m			DOL-1204-W05MC		6025904	-	●	-	
	10 m			DOL-1204-W10MC		6025905	-	●	-	

Figure	Connector	Configuration	Jacket material	Cable length	Model name	Part no.	Flying leads, 3-wire	Flying leads, 4-wire	Flying leads, 5-wire
	Female connector M12, 4-pin, with 3 LEDs (PNP)	Right angle	PVC	2 m	DOL-1204-L02M	6027945	-	●	-
				5 m	DOL-1204-L05M	6027944	-	●	-
				10 m	DOL-1204-L10M	6027946	-	●	-
	Female connector M12, 5-pin	Straight	PVC	2 m	DOL-1205-G02M	6008899	-	-	●
				5 m	DOL-1205-G05M	6009868	-	-	●
				10 m	DOL-1205-G10M	6010544	-	-	●
	Female connector M12, 5-pin, shielded	Straight	PUR halogen free	2 m	DOL-1205-G02MC	6025906	-	-	●
				5 m	DOL-1205-G05MC	6025907	-	-	●
				10 m	DOL-1205-G10MC	6025908	-	-	●
	Female connector M12, 5-pin, shielded	Right angle	PUR halogen free	5 m	DOL-1205-G05MAC	6036384	-	-	●
				10 m	DOL-1205-G10MAC	6036385	-	-	●
				5 m	DOL-1205-W05MAC	6041751	-	-	●
				10 m	DOL-1205-W10MAC	6041752	-	-	●

Single-ended cordset dimensional drawings

DOL-0803-GxxM

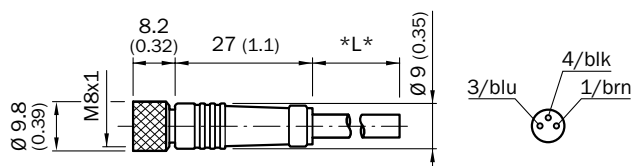

Dimensions in mm (inch)

DOL-0803-GxxMC

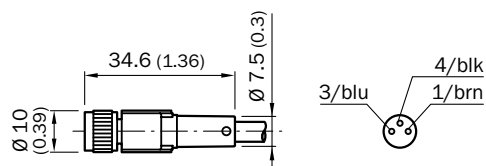

Dimensions in mm (inch)

DOL-0803-WxxM

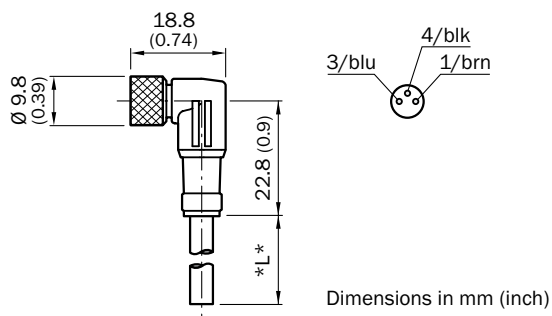

Dimensions in mm (inch)

DOL-0803-WxxMC

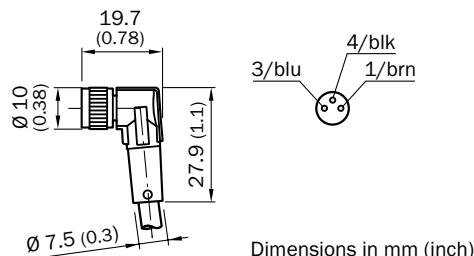

Dimensions in mm (inch)

DOL-0804-GxxM

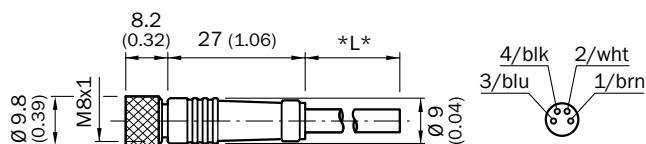

All dimensions in mm (inch)

DOL-0804-GxxMC

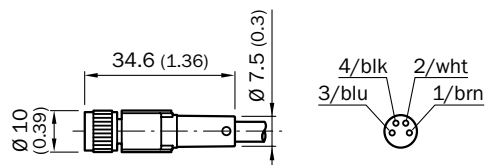

Dimensions in mm (inch)



DOL-0804-WxxM

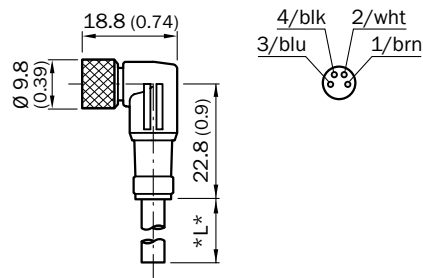

All dimensions in mm (inch)

DOL-0804-WxxMC

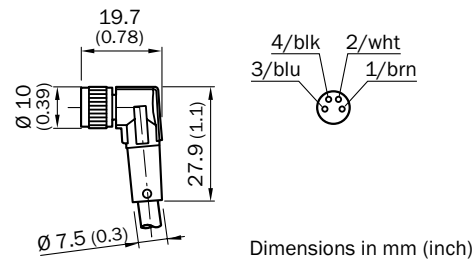

Dimensions in mm (inch)

DOL-1204-GxxM

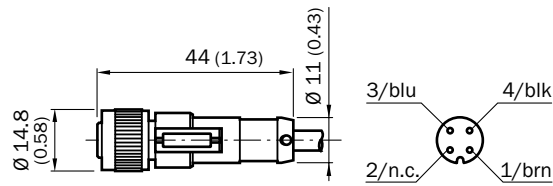

Dimensions in mm (inch)

DOL-1204-GxxMC

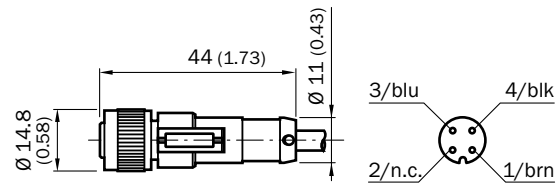

Dimensions in mm (inch)

DOL-1204-WxxM

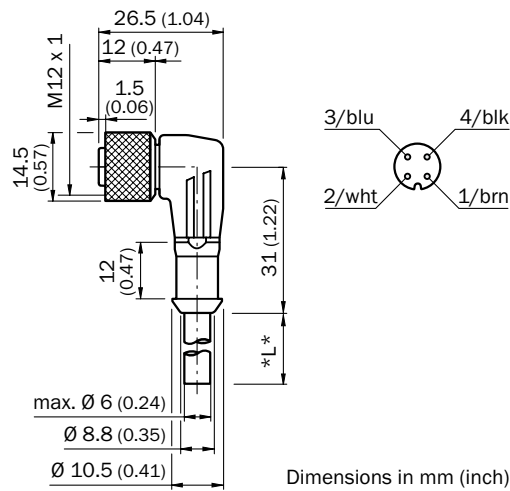

Dimensions in mm (inch)

DOL-1204-WxxMC

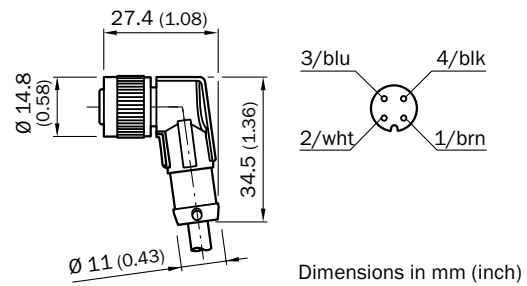

Dimensions in mm (inch)

DOL-1204-LxxM

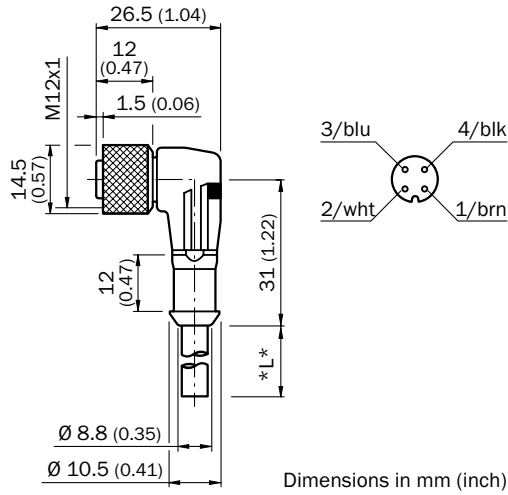

DOL-1205-GxxM

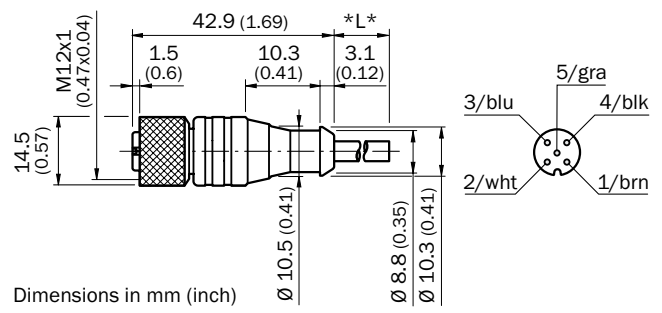

DOL-1205-GxxMC, DOL-1205-GxxMAC

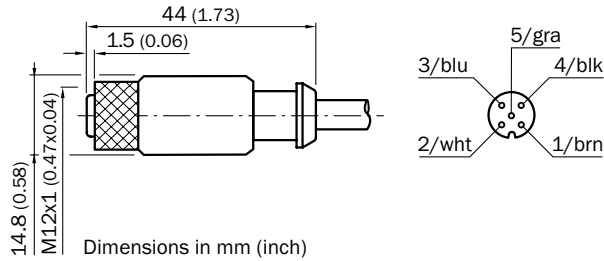

DOL-1205-WxxMAC

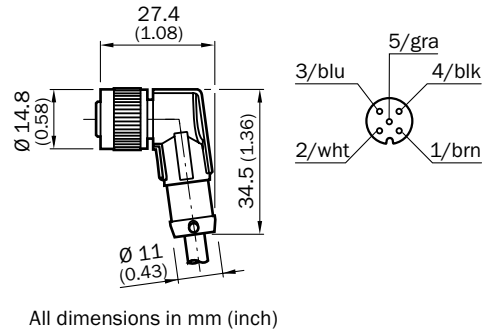

Double-ended cordsets

Figure	Connector	Configuration	Jacket material	Cable length	Model name	Part no.	M8, 3-pin	M8, 4-pin	M12, 4-pin	M12, 5-pin
	Female M8 / Male M12	Straight M8 / Straight M12	PVC	0.6 m	DSL-8203-G0M6	6022570	●	-	-	-
				2 m	DSL-8203-G02M	6022572	●	-	-	-
PUR halogen free			0.6 m	DSL-8203-G0M6C	6025914	●	-	-	-	
			2 m	DSL-8203-G02MC	6025915	●	-	-	-	
		Right angle M8 / Straight M12	PUR halogen free	0.6 m	DSL-8203-B0M6C	6025916	●	-	-	-
				2 m	DSL-8203-B02MC	6025917	●	-	-	-
	5 m			DSL-8203-B05MC	6039185	●	-	-	-	

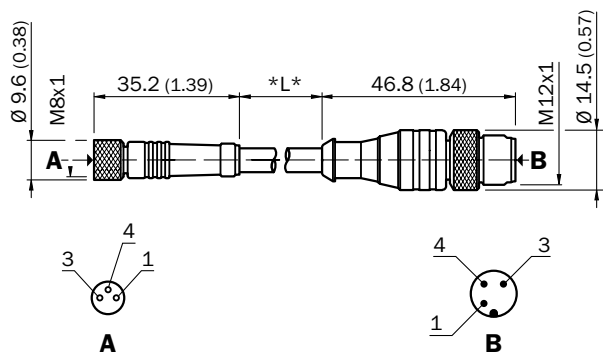

Figure	Connector	Configuration	Jacket material	Cable length	Model name	Part no.	M8, 3-pin	M8, 4-pin	M12, 4-pin	M12, 5-pin			
	Female M8 / Male M12	Straight M8 / Straight M12	PVC	0.6 m	DSL-8204-G0M6	6022571	-	●	-	-			
				2 m	DSL-8204-G02M	6022573	-	●	-	-			
				5 m	DSL-8204-G05M	6034403	-	●	-	-			
				10 m	DSL-8204-G10M	6034404	-	●	-	-			
		PUR halogen free	Straight M8 / Straight M12	PUR halogen free	0.6 m	DSL-8204-G0M6C	6025918	-	●	-	-		
					2 m	DSL-8204-G02MC	6025919	-	●	-	-		
					5 m	DSL-8204-G05MC	6039181	-	●	-	-		
		Right angle M8 / Straight M12	Right angle M8 / Straight M12	PUR halogen free	0.6 m	DSL-8204-B0M6C	6025920	-	●	-	-		
	2 m				DSL-8204-B02MC	6025921	-	●	-	-			
	5 m				DSL-8204-B05MC	6039182	-	●	-	-			
	Female M8 / Male M8	Straight M8 / Straight M8	PVC	0.6 m	DSL-0804-G0M6	6034664	-	●	-	-			
				1.5 m	DSL-0804-G1M5	6042050	-	●	-	-			
				2 m	DSL-0804-G02M	6034665	-	●	-	-			
				20 m	DSL-0804-G20M	6039087	-	●	-	-			
				PUR halogen free	Straight M8 / Straight M8	PUR halogen free	0.6 m	DSL-0804-G0M6C	6039089	-	●	-	-
							2 m	DSL-0804-G02MC	6036335	-	●	-	-
							5 m	DSL-0804-G05MC	6039090	-	●	-	-
	Female M12 / Male M12	Straight M12 / Straight M12	PVC	0.6 m	DSL-1204-G0M6	6022565	-	-	●	-			
				1.5 m	DSL-1204-G1M5	6034822	-	-	●	-			
				2 m	DSL-1204-G02M	6022567	-	-	●	-			
				5 m	DSL-1204-G05M	6022569	-	-	●	-			
				10 m	DSL-1204-G10M	6034406	-	-	●	-			
				PUR halogen free	Straight M12 / Straight M12	PUR halogen free	0.6 m	DSL-1204-G0M6C	6025926	-	-	●	-
							1 m	DSL-1204-G01MC	6033244	-	-	●	-
							2 m	DSL-1204-G02MC	6025927	-	-	●	-
							5 m	DSL-1204-G05MC	6033245	-	-	●	-
							10 m	DSL-1204-G10MC	6033698	-	-	●	-
	Femal M12 / Male M12	Straight M12 / Straight M12	PUR halogen free	1 m	DSL-1205-G01MC	6029280	-	-	-	●			
				1.5 m	DSL-1205-G1M5C	6029281	-	-	-	●			
				2 m	DSL-1205-G02MC	6025931	-	-	-	●			
				5 m	DSL-1205-G05MC	6029282	-	-	-	●			
				10 m	DSL-1205-G10MC	6038954	-	-	-	●			
				15 m	DSL-1205-G15MC	6038956	-	-	-	●			
				20 m	DSL-1205-G20MC	6038957	-	-	-	●			



Double-ended cordset dimensional drawings

DSL-8203-GxMx, DSL-8203-GxxM



Dimensions in mm (inch)

DSL-8203-GxMxC, DSL-8203-GxxMC

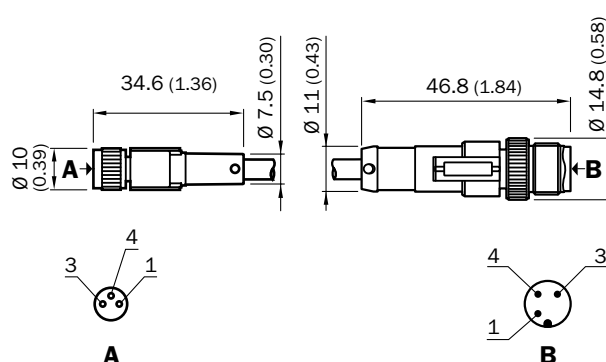

Dimensions in mm (inch)

DSL-8203-BxMxC, DSL-8203-BxxMC

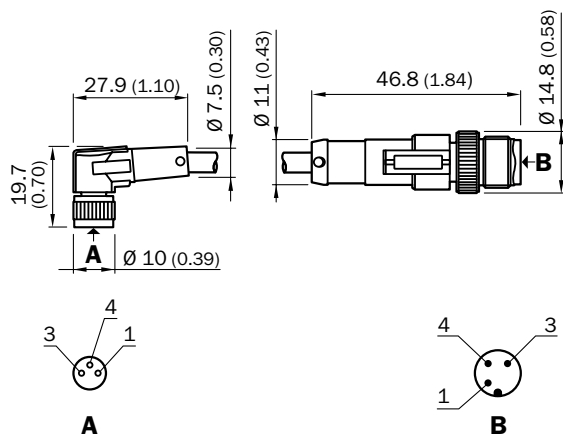

Dimensions in mm (inch)

DSL-8204-GxMx, DSL-8204-GxxM

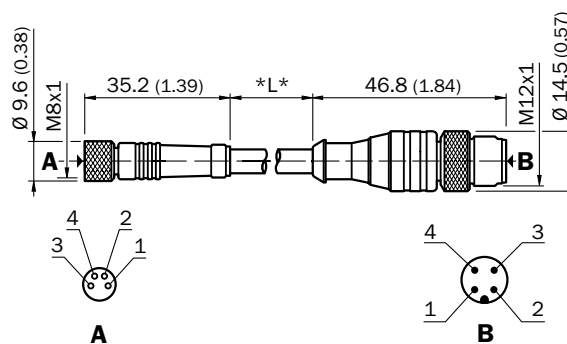

Dimensions in mm (inch)

DSL-8204-GxMxC, DSL-8204-GxxMC

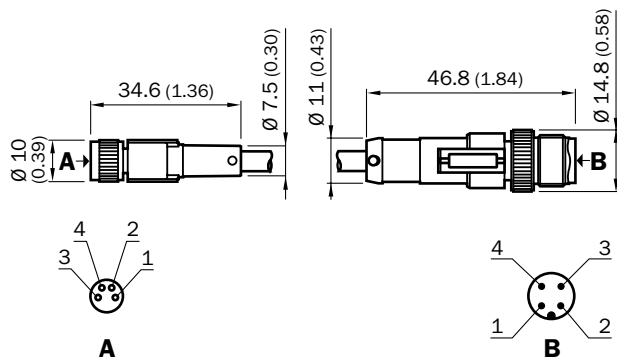

Dimensions in mm (inch)

DSL-8204-BxMxC, DSL-8204-BxxMC

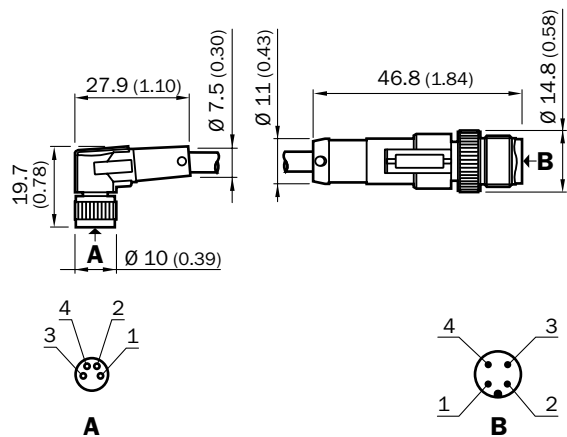

Dimensions in mm (inch)



DSL-0804-GxMx, DSL-0804-GxxM

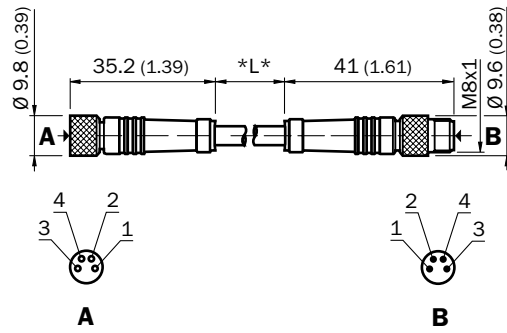

Dimensions in mm (inch)

DSL-0804-GxMxC, DSL-0804-GxxMC

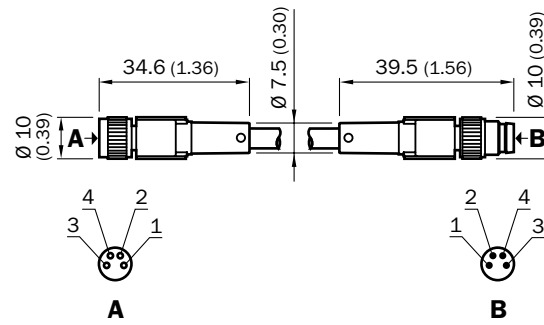

Dimensions in mm (inch)

DSL-1204-GxMx, DSL-1204-GxxM

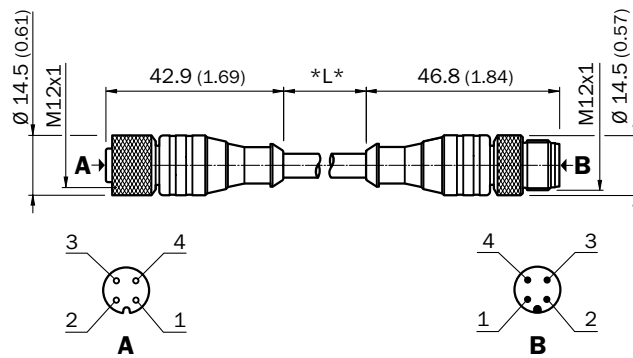

Dimensions in mm (inch)

DSL-1204-GxMxC, DSL-1204-GxxMC

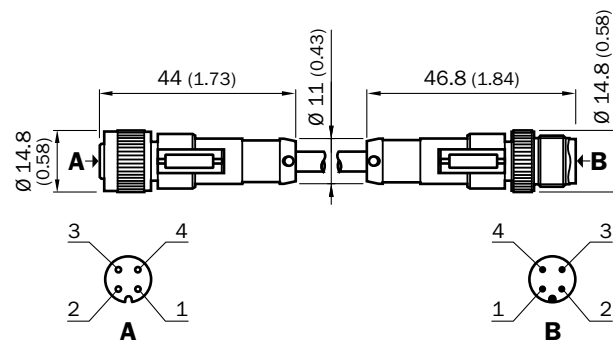

Dimensions in mm (inch)



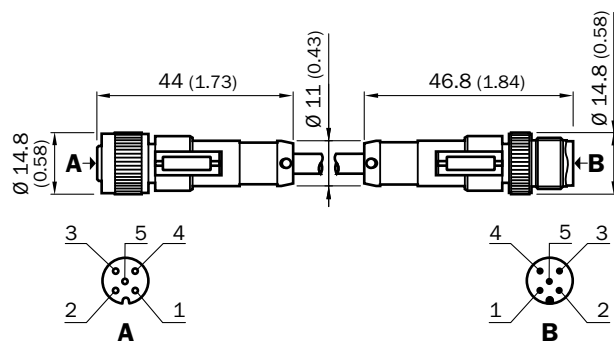





DSL-1205-GxMxC, DSL-1205-GxxMC



Dimensions in mm (inch)

Food & Beverage cordsets

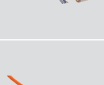
- For inductive proximity sensors **IMF Food & Beverage** and **IM Inox**
- For capacitive proximity sensors **CM PTFE**
- **Enclosure rating:** IP 69K
- Female connector and flying leads

Figure	Connector	Configuration	Jacket material	Cable length	Model name	Part no.	Flying leads, 3-wire	Flying leads, 4-wire	Flying leads, 5-wire
	Female connector M8, 3-pin	Straight	PVC	2 m	DOL-0803-G02MN	6033664	●	-	-
				5 m	DOL-0803-G05MN	6033665	●	-	-
				10 m	DOL-0803-G10MN	6033666	●	-	-
	Female connector M8, 3-pin	Right angle	PVC	2 m	DOL-0803-W02MN	6033667	●	-	-
				5 m	DOL-0803-W05MN	6033668	●	-	-
				10 m	DOL-0803-W10MN	6033669	●	-	-
	Female connector M8, 4-pin	Straight	PVC	2 m	DOL-0804-G02MN	6033670	-	●	-
				5 m	DOL-0804-G05MN	6033671	-	●	-
				10 m	DOL-0804-G10MN	6033672	-	●	-
	Female connector M8, 4-pin	Right angle	PVC	2 m	DOL-0804-W02MN	6033673	-	●	-
				5 m	DOL-0804-W05MN	6033674	-	●	-
				10 m	DOL-0804-W10MN	6033675	-	●	-
	Female connector M12, 4-pin	Straight	PVC	2 m	DOL-1204-G02MN	6028128	-	●	-
				5 m	DOL-1204-G05MN	6028130	-	●	-
				10 m	DOL-1204-G10MN	6028132	-	●	-
	Female connector M12, 4-pin	Right angle	PVC	2 m	DOL-1204-W02MN	6028129	-	●	-
				5 m	DOL-1204-W05MN	6028131	-	●	-
				10 m	DOL-1204-W10MN	6028133	-	●	-
	Female connector M12, 4-pin	Right angle	PVC	25 m	DOL-1204-W25MN	6028135	-	●	-
				2 m	DOL-1204-L02MN	6028136	-	●	-
				5 m	DOL-1204-L05MN	6028137	-	●	-
	Female connector M12, 4-pin	Right angle	PVC	10 m	DOL-1204-L10MN	6028138	-	●	-
				25 m	DOL-1204-L25MN	6028139	-	●	-
				2 m	DOL-1205-G02MN	6028140	-	-	●
	Female connector M12, 5-pin	Straight	PVC	5 m	DOL-1205-G05MN	6028141	-	-	●
				10 m	DOL-1205-G10MN	6028142	-	-	●



- Food & Beverage double-ended cordsets

Figure	Connector	Configuration	Jacket material	Cable length	Model name	Part no.	M12, 4-pin
	Female M12 / Male M12	Straight female / straight male	PVC	0.6 m	DSL-1204-G0M6N	6028194	●
				2 m	DSL-1204-G02MN	6028195	●
				5 m	DSL-1204-G05MN	6028196	●
		PVC	Right angle female / Straight male	0.6 m	DSL-1204-B0M6N	6028197	●
				2 m	DSL-1204-B02MN	6028198	●
				5 m	DSL-1204-B05MN	6028199	●

Food & Beverage cordset dimensional drawings

DOL-0803-GxxMN, DOL-0804-GxxMN

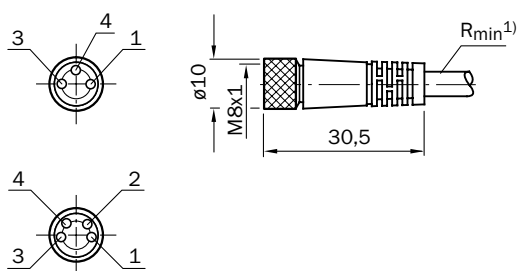

DOL-0803-WxxMN, DOL-0804-WxxMN

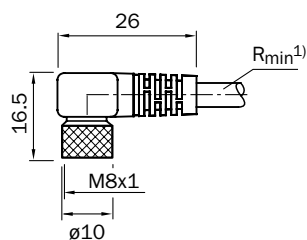

DOL-1204-GxxMN, DOL-1205-GxxMN

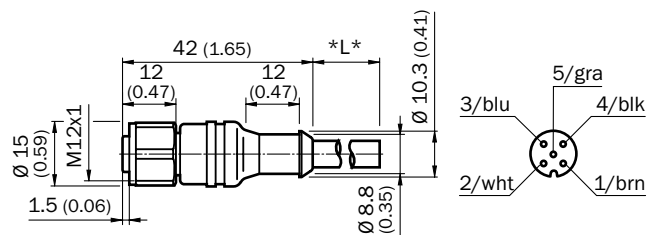

Dimensions in mm (inch)

DOL-1204-WxxMN

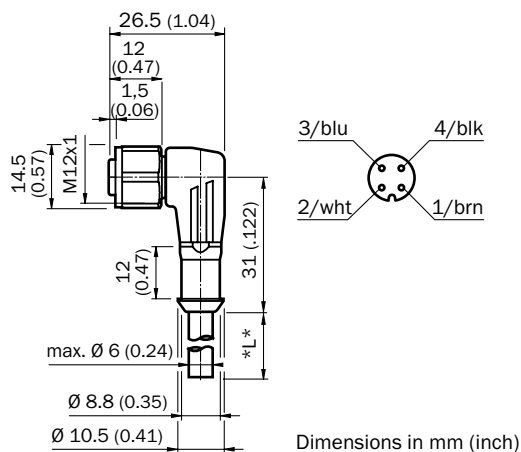

Dimensions in mm (inch)



DOL-1204-LxxMN

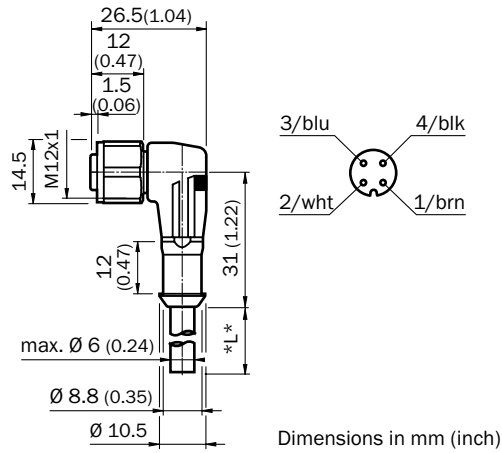

DSL-1204-GxxMN

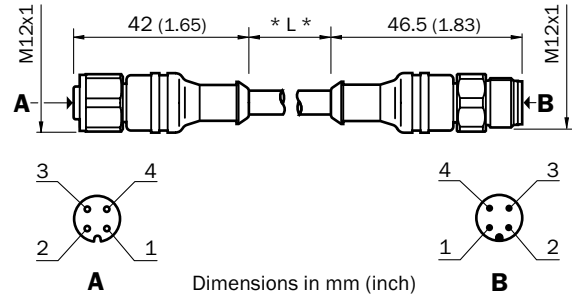

DSL-1204-BxxMN

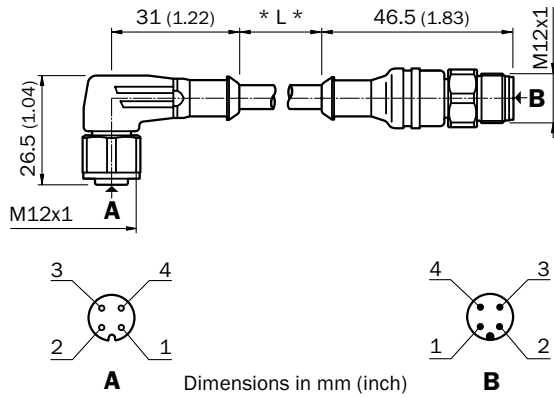

Field wireable connectors

Figure	Connector	Connector	Pins	Configuration	Jacket material	Model name	Part no.
	Female connector	M8	3-pin	Straight	PBT	DOS-0803-G	7902077
				Right angle		DOS-0803-W	7902078
			4-pin	Straight	PBT	DOS-0804-G	6009974
				Right angle		DOS-0804-W	6009975
		M12	4-pin	Straight	PBT	DOS-1204-G	6007302
					PBT, stainless steel hex nut	DOS-1204-GN	6028357
				Right angle	PBT	DOS-1204-W	6007303
					PBT, stainless steel hex nut	DOS1204-WN	6028358
		M12	5-pin	Straight	-	DOS-1205-G	6009719
				Right angle	-	DOS-1205-W	6009720
	Male connector	M8	3-pin	Straight	PBT	STE-0803-G	6037322
			4-pin	Straight	PBT	STE-0804-G	6037323
		M12	4-pin	Straight	PBT	STE-1204-G	6009932
					PBT, stainless steel hex nut	STE-1204-GN	6028359
	Right angle	PBT	STE-1204-W	6022084			
	Duo-male connector	M12	4-pin	Straight	PBT, stainless steel hex nut	STE-1204-TN	6028360
	Male connector	M12	5-pin	Straight	PBT	STE-1205-G	6022083
				Right angle	PBT	STE-1205-W	6022082

Field wireable connector dimensional drawings

DOS-0803-G

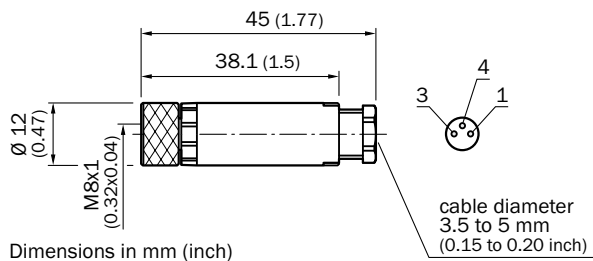

DOS-0803-W

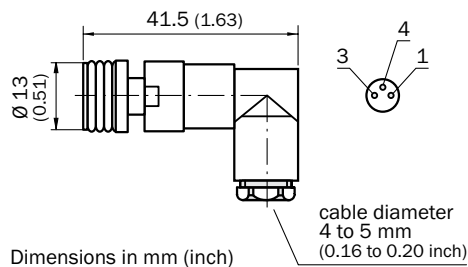

DOS-0804-G

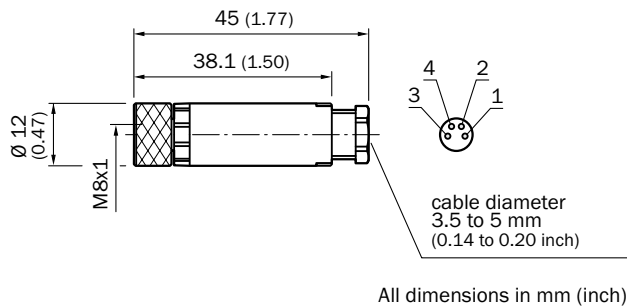

DOS-0804-W

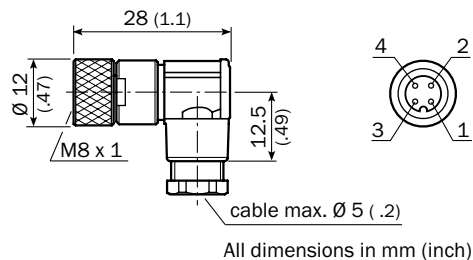

DOS-1204-G(N)

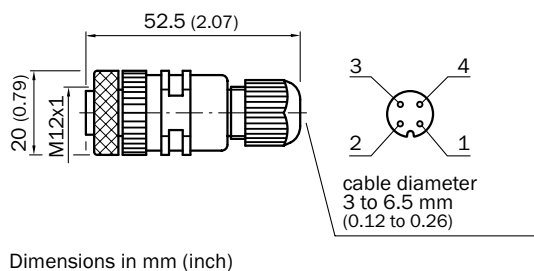

DOS-1204-W(N)

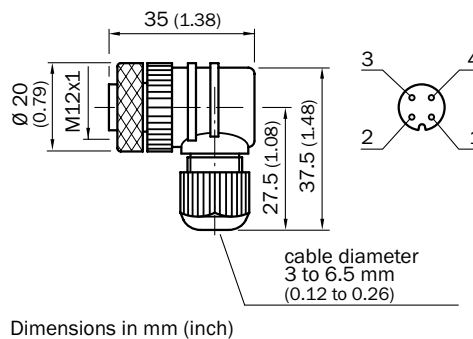

DOS-1205-G

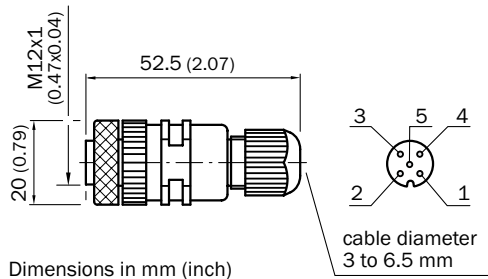

DOS-1205-W

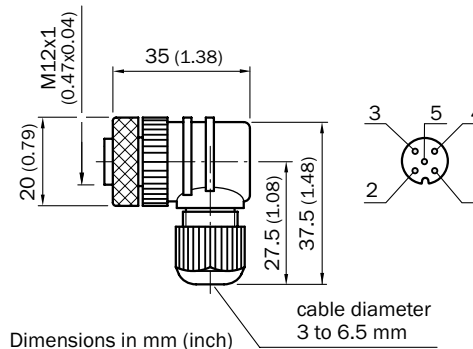

STE-0803-G

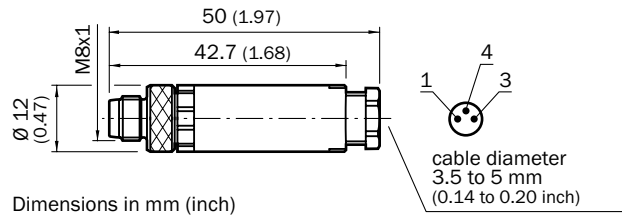

STE-0804-G

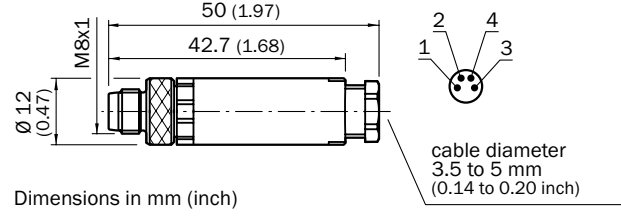

STE-1204-G(N)

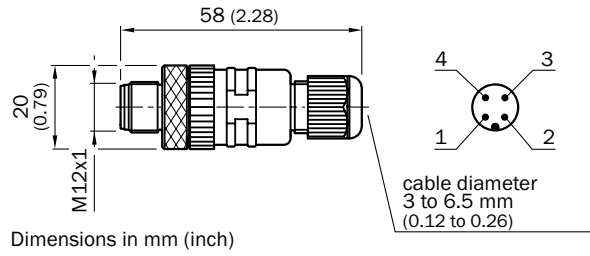

STE-1204-W

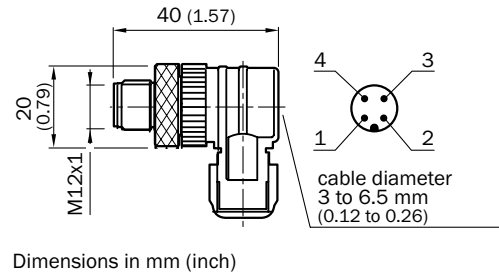

STE-1204-TN

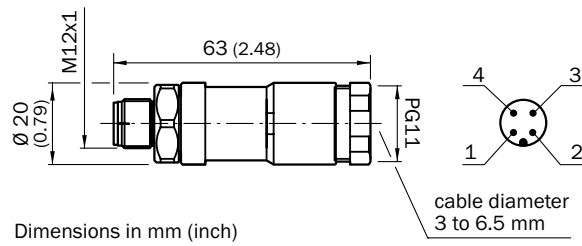

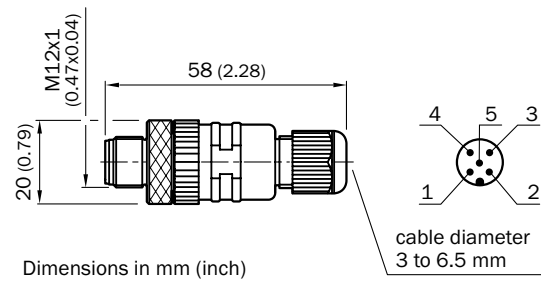

STE-1205-G

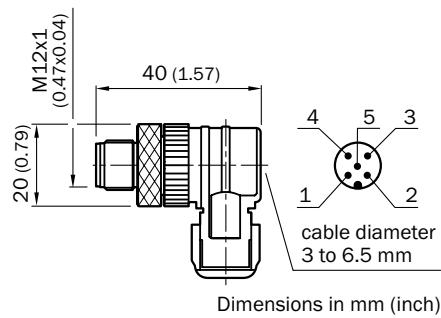

STE-1205-W



Intrinsically safe Namur amplifier

Figure	Supply voltage	Output function	Approvals	Model name	Part no.	IM Namur	MM Namur
	AC/DC 24 ... 230 V ¹⁾	2 channels with invertible SPDT relay	II (1) G [Ex ia] IIC II (1) D [Ex iaD] II (3) G Ex nAC [ia] IIC T4 X	EN2-2EX-1	6041096	●	●
	DC 19.2 ... 30 V	2 channels with invertible NO relay	II (1) GD [Ex ia] IIC, IIB II (3) G Ex nAC II T4 X	EN2-2EX-3	6041095	●	●

Intrinsically safe Namur amplifier dimensional drawings

EN2-2EX-1

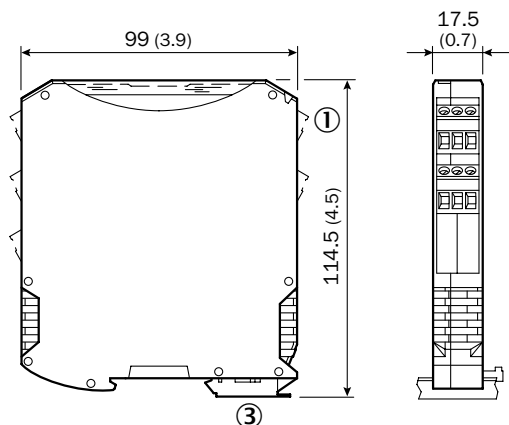

- ① Screw terminals
- ③ Metal lock for DIN rail mounting

EN2-2EX-3

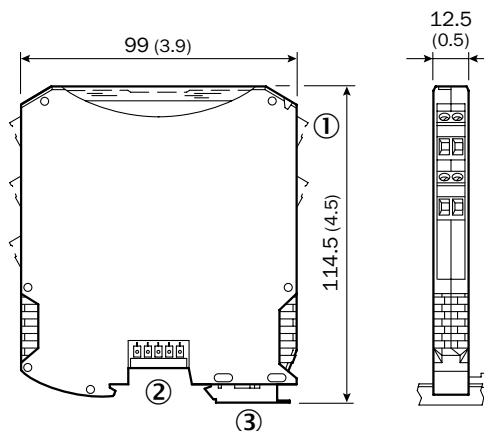

- ① Screw terminals
- ② DIN rail mounting
- ③ Metal lock for DIN rail mounting

Dimensions in mm (inch)







Important information about SICK sensor solutions

From A for Active area to W for Wire-break protection, the following pages contain explanations of key terminology in a concise, easy-to-read format. Definitions of all key terms related to innovations and proximity sensor solutions from SICK can be found here.

This glossary also provides valuable information about directives and standards such as conformity, protection classes, electrical characteristics and much more.

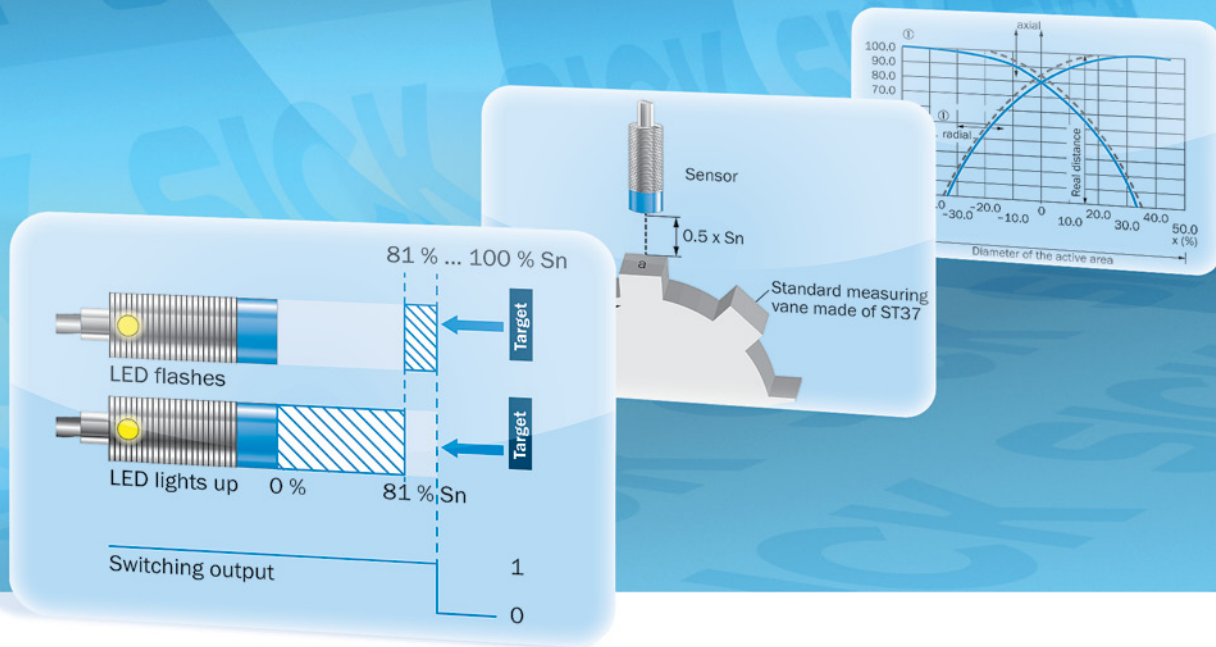

Appendix

Glossary	H-284
Explosion protection according to ATEX.	H-292
Index	H-294

A

Active area

The active area of a proximity sensor is defined as the area covered by the sensing range. It is also the area over which the sensor responds to the approach of activated material through an output state change.

Adjustment indicators

The optical adjustment indicators enables fast adjustment of the sensors. The LED indicator flashes in the range 81 – 100% of the nominal sensing range and in continuous display overflow when it reaches the secure sensing range (81%).

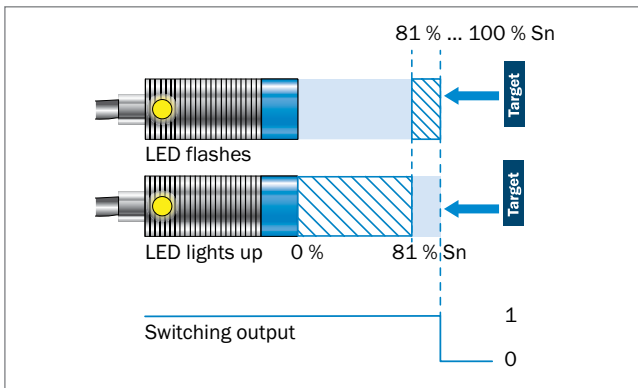

Ambient temperature, operation/storage

The ambient temperature indicates the range within which the proximity sensor works properly.

Assured sensing range Sa

→ See "Sensing range assured Sa" on page H-288

ATE Directive 94/5/EC

→ See "Explosion protection according to ATEX" on page H-292

B C

Bandwidth

The bandwidth describes the highest frequency for periodic sensor operation, where the output signal decreases by less than 3 dB. Bandwidth is always measured at half sensing range ($\frac{1}{2} S_n$).

Coercive field strength H

The coercive field strength H is the required negative field strength in kA/m (or Oersted Oe) that is necessary to demagnetize a magnet. The higher the value, the better the demagnetization resistance. A distinction is made between BHC and JH0. The coercive field strength JH0 is important for all magnetic materials with small remanence and high coercive field strength (e.g., barium ferrite). JH0 results from the hysteresis loop.

Current consumption

Power consumption refers to the current consumption of 3- and 4-wire sensors without a load being connected.

Current consumption, attenuated

→ See "NAMUR" on page H-286

Current consumption, unattenuated

→ See "NAMUR" on page H-286

E F

EC-type examination certificate

→ See "Explosion protection according to ATEX" on page H-292

Electrical wiring

Example connection diagram DC 2-wire:

2-wire, NO

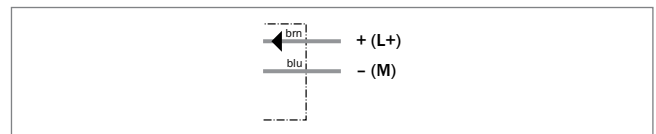

Example connection diagram DC 3-wire:

3-wire PNP, NO

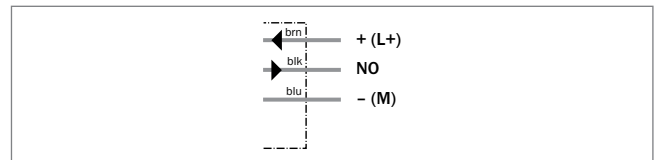

3-wire, NPN, NC

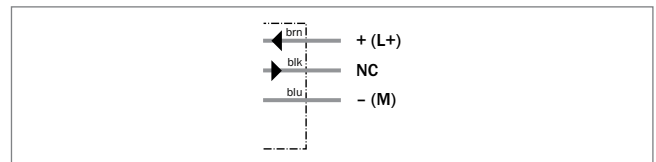

Example connection diagram DC 4-wire:

4-wire, NC / NO

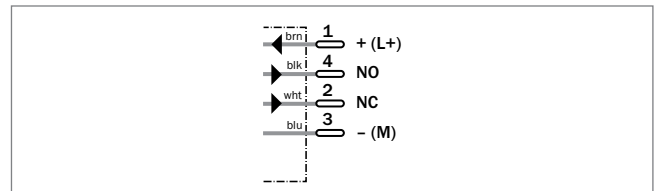

→ See "Output function" on page H-287

EMC

According to EC Directive 2004/108/EC on electromagnetic compatibility, systems and components must satisfy certain properties in order to function smoothly in an electromagnetic environment.

Enclosure rating

The IP enclosure rating indicates the extent of a device's protection against contact with impurities such as dust or water. The code starts with the letters IP and is followed by the first digit, which is an ascending indicator of the degree of protection against contact and impurities, while the second digit is an indicator of protection against ingress of water:

- IP 65: Complete protection against dust and protection against water jets
- IP 67: Complete protection against dust and protection against water in 1 m of water for a period of 30 minutes at a constant room temperature
- IP 68: Freely definable
- IP 69K: Protection against high pressure cleaning according to EN 60529. Jet duration 30s depending on jet angle 0 - 90° in 30° steps at a water pressure of 80 - 100 bar and a water temperature of 80 ± 5 °C.

→ See "Table of IP enclosure ratings" on page H-290

Equipment category

→ See "Explosion protection according to ATEX" on page H-292

Equipment groups

→ See "Explosion protection according to ATEX" on page H-292

Ex area category

→ See "Explosion protection according to ATEX" on page H-292

Explosive groups

→ See "Explosion protection according to ATEX" on page H-292

External Teach

Allows the user to make the required settings via the control cable of the sensor.

H I J

Hysteresis

Hysteresis describes the difference between the activation and deactivation point of the sensor based on the target's axial approach to the active sensor area. The hysteresis is defined as a percentage of the real sensing range S_r .

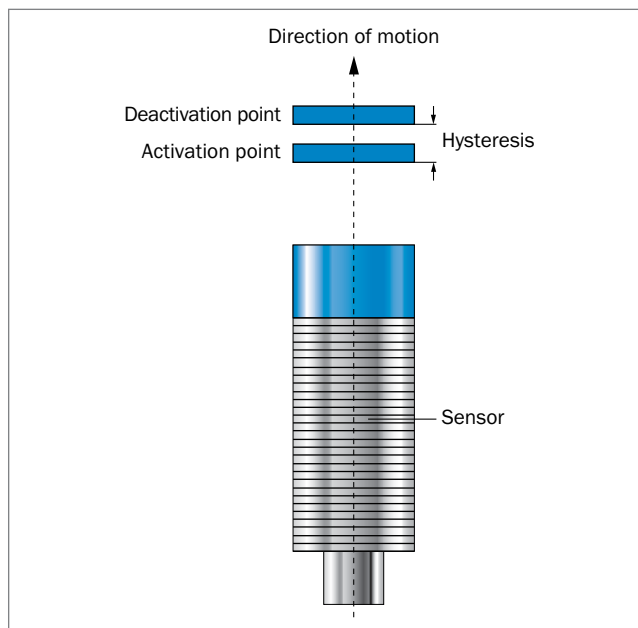

Installation type

Flush

Flush proximity sensors can be mounted with the active area flush in an activated material. These sensors can also be installed non-flush.

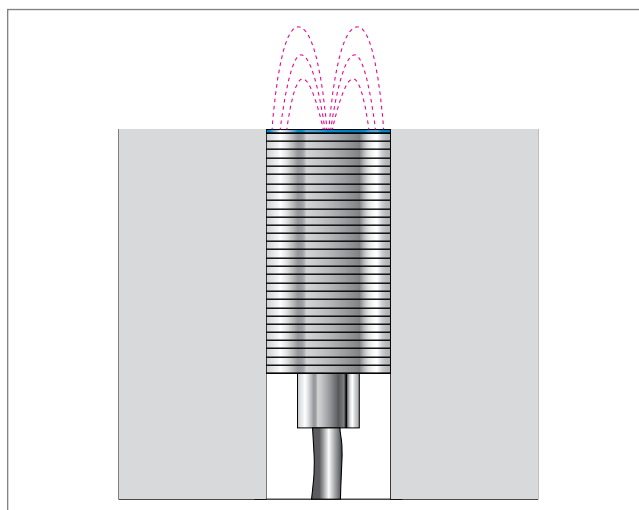

Non-flush

A non-flush proximity sensor requires free space around the active area, in which there should be no activated material. The size of the space is based on the type. The sensing range is greater than with flush versions.

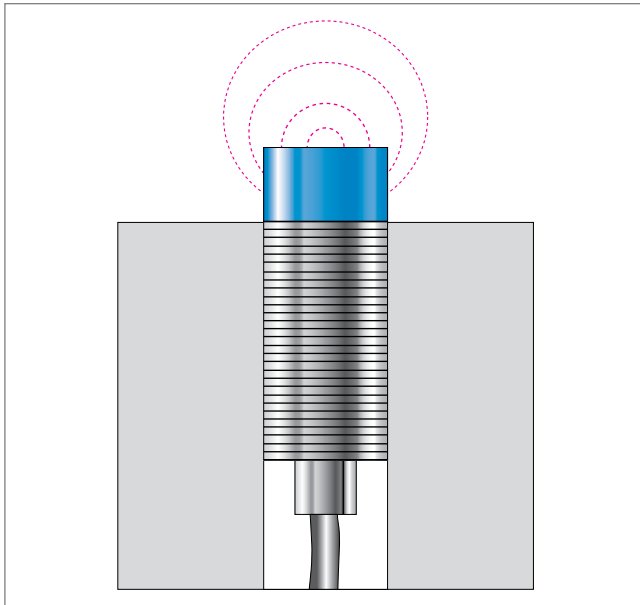

Quasi-flush

A quasi-flush proximity sensor requires free space around the active area, in which there should be no activated material. The size of the space is based on the type. Although these sensors look identical to flush sensors, they may not be completely enclosed by metal.

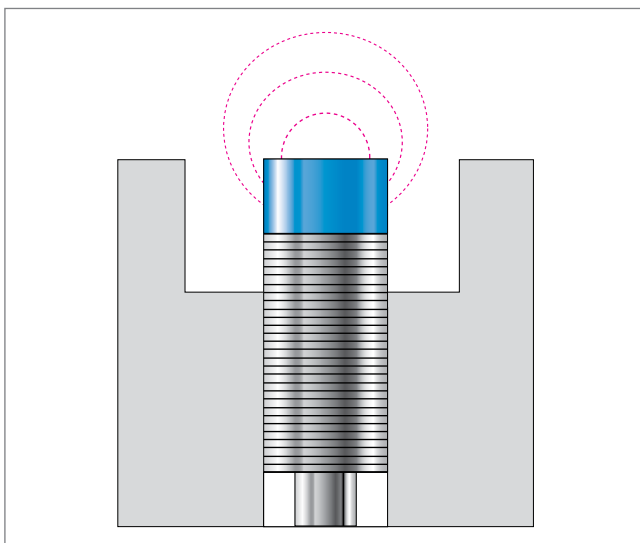

L

Lateral approach

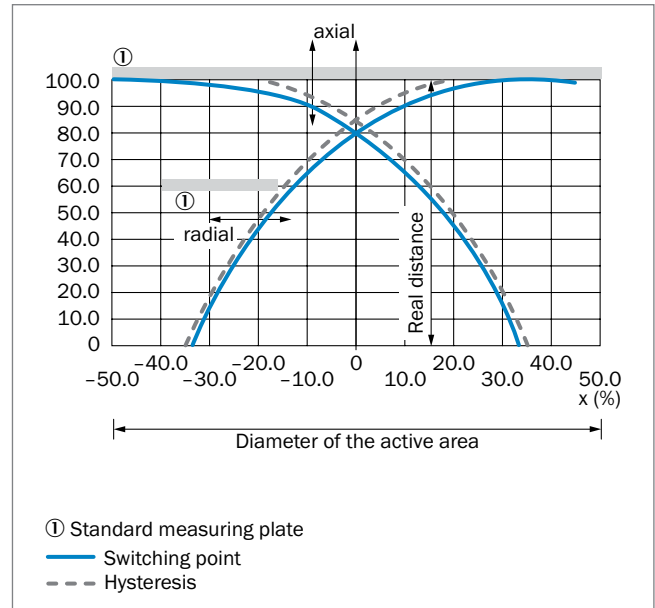

Load resistance, min.

Describes the smallest current which is required for self-supply of 2-wire sensors to function in the switched-on state.

M

Magnetic alignment

Responds to magnetic field lines that only act on the sensor through the front of the housing (axial axis).

Max. tightening torque

The maximum allowable force that can be used when turning a thread without damaging the thread. For sensors with a cylindrical design, it prevents overextending the sensor housing.

Minimum operating current I_m

→ See "Load resistance, min." on page H-286

N O P Q

NAMUR

Standardization association for measurement and control.

No-load current

→ See "Current consumption" on page H-284

Nominal sensing range

→ See "Sensing range S_n " on page H-288

Nominal sensitivity

→ See "Sensitivity" on page H-288

Off-state current

Describes the current flowing in the off state in the load circuit of the proximity sensor.

Output current Ia

Constant current is defined as the maximum load current for continuous operation.

Output current QA

The current for analog devices, which is present at the output and varies depending on the distance (e.g., in a range of 4–20 mA).

Output function**NO**

A proximity sensor's output circuit with NO function is energized when a target is detected, and de-energized when no target is detected.

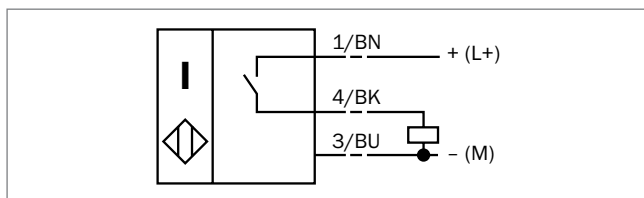
**NC**

A proximity sensor's output circuit with NC function is de-energized when a target is detected, and energized when no target is detected.

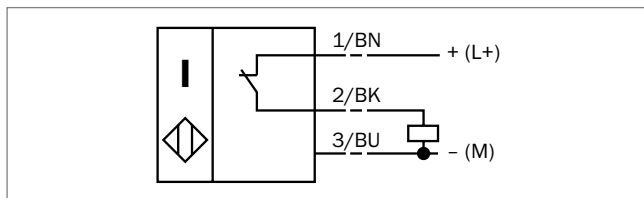
**Complementary output**

Both NO and NC signals are available simultaneously to a proximity sensor with complementary function.

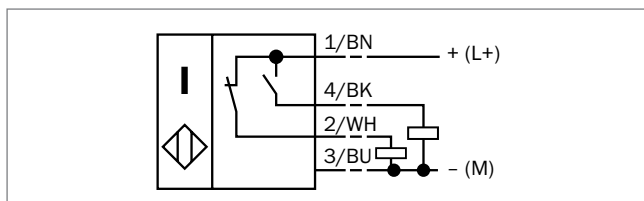
**Programmable**

A proximity sensor with programmable function can, depending on the type, provide NO or NC function and can sometimes even implement PNP or NPN outputs. The type of programming is dependent on the particular type of sensor and can be found in the manual.

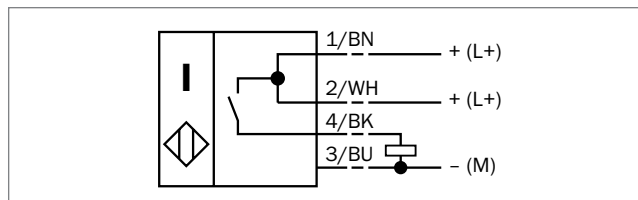
**Output type**

A output type is the output via which the switching state of the sensor is digitally outputted.

NPN output

The negative potential is connected to the load. This output is also referred to as negative switching or current-sinking.

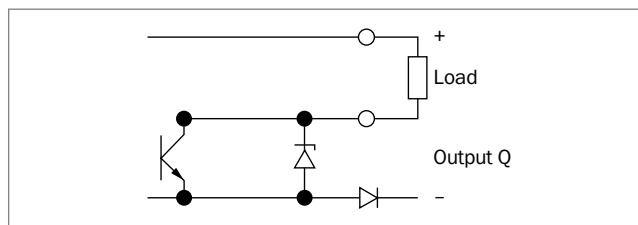
**PNP output**

The positive potential is connected to the load. This output is also known as positive switching or current sourcing.

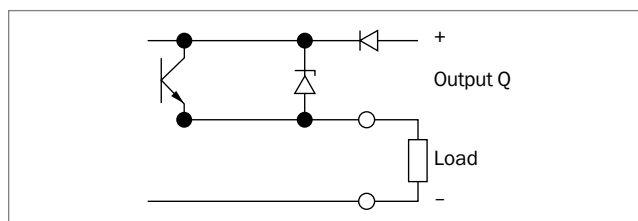
**Output voltage QA**

The voltage for analog devices, which is present at the output and varies depending on the distance (between switching target and sensor) (e.g., in a range of 0 - 10 V).

Power-up pulse protection

The power-up pulse suppression is used to suppress pulses at the output in the time between application of the operating voltage and oscillation of the oscillator.

Protection class

Electrical equipment is classified in relation to existing safety measures for prevention of electric shocks. Protection classes are defined in DIN EN 61140. There are four protection classes ranging from “Basic insulation” (Class 0) to “Safety extra-low voltage (Class 1), double insulation (Class 2), safety transformer” (Class 3).

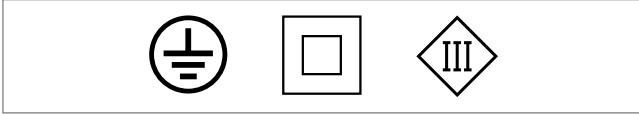

Left: Protection Class 1; middle: Protection Class 2; right: Protection Class 3

R

Real sensing range S_r

The sensing range of an individual proximity switch that is measured at a specified voltage, defined installation conditions and a temperature of $23 \pm 5^\circ\text{C}$.

Reduction factor R_m

When using targets made of a material that does not meet the requirements of the standard target, the sensing range is reduced based on the material used. This behavior is described by the reduction factor.

→ See “The reduction factor (R_m)” on page B-16

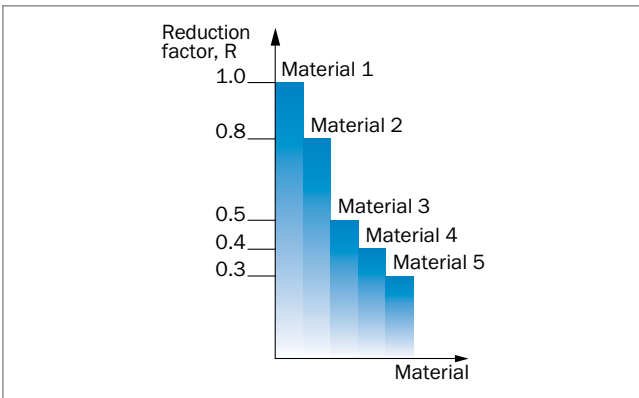

Remanence B_r

The remanence B_r is specified in tesla (T) or millitesla (mT), in the CGS measuring system in gauss (G). The remanence is the remaining magnetization in a magnet or flux density, which has been magnetized in a closed circuit to saturation.

Repeatability

The repeatability describes the percentage deviation of the switching point. It is measured over a period of eight hours at an ambient temperature of $23 \pm 5^\circ\text{C}$, relative humidity up to 90 % and a fixed supply voltage of 24 V DC for DC devices or 230 V AC for AC devices.

The difference between any two measurements shall not exceed 10% of the real sensing range (S_r).

This definition applies only for sensors with output type stage.

Resolution

The resolution describes the smallest possible change that can be detected by the sensor.

Reverse polarity protection

Reverse polarity protection is protection built into a proximity sensor against damage caused by mixing supply voltage connections.

Ripple

Residual ripple is defined as the superimposed AC component (maximum allowable peak, expressed as a % of U_{U_V}) of the DC operating voltage (typically 10%).

S

Sensing range assured S_a

The distance at which a response of the proximity sensor is ensured under the specified temperature, installation and voltage conditions.

Sensing range S_n

The distance at which the active surface axially approaching standard switching flag triggers a signal change. Manufacturing deviations and external factors are not considered.

Sensing range S_r

→ See “Real sensing range S_r ” on page H-288

Sensitivity

Represents the strength of the magnetic field in mT (millitesla), which is necessary to activate the sensor. Sensors with high sensitivity can detect even weak magnetic fields.

Shock resistance

According to IEC 60068-2-27

6 shocks (six separate tests) are executed in each direction along three mutually perpendicular axes:

- Pulse shape: half sine
- Acceleration: $\leq 30\text{ g}$
- Pulse duration: 11 ms

Short-circuit protection

Short-circuit protection protects against overload and a direct short circuit. After exceeding the trigger threshold, the output is disabled. Then it is periodically (pulsed) queried whether the short circuit persists. After eliminating the short-circuit, the output is switched on again.

Short-time withstand current

Describes the current which can temporarily flow in the load circuit, without the sensor being destroyed.

Supply voltage

The supply voltage describes the voltage range within which the proximity sensor works properly.

Switching frequency

The switching frequency is defined as the maximum number of times the activated state is switched to the deactivated state in hertz. It is measured using a half sensing range ($\frac{1}{2} S_n$) and a standard target. The measurement value shall be satisfied if either the on-time (t_1) or off-time (t_2) is less than 50 microseconds.

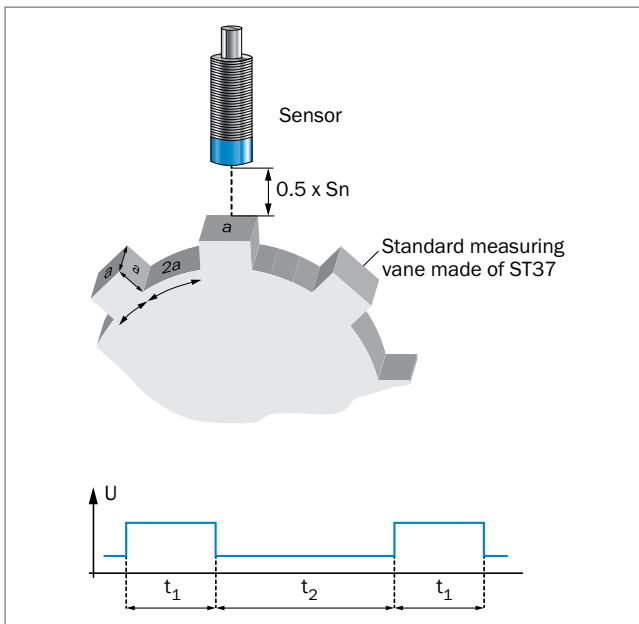

T

Teach-in

→ See "External Teach" on page H-285

Temperature classes

→ See "Explosion protection according to ATEX" on page H-292

Temperature drift (% of S_r)

Temperature drift is a shift in the switching point caused by a change in ambient temperature.

Time delay before availability

The time delay before availability is the time it takes for the proximity sensor to be ready after power-up.

Types of flammable protection

→ See "Explosion protection according to ATEX" on page H-292

V

Vibration resistance

According to IEC 60068-2-6

The test shall be conducted in three mutually perpendicular axes under the following conditions:

Frequency range: 10 to 55 Hz

Amplitude: 1 mm

Oscillation period: 5 min

Duration of the service life at resonance frequency or at 55 Hz: 30 min on each axis.

Voltage drop

Voltage drop is defined as the voltage loss that occurs with maximum continuous current I_a across the switching stage of the proximity switch. In particular, this behavior is observed in the series circuit.

W

Wire-break protection

Due to broken wire protection, the output remains locked if the supply cable breaks. Malfunctions are thereby prevented.

Table of IP enclosure ratings

<p>2nd digit: Protection against ingress of water</p>											
		No protection	Drip-water vertical	Drip-water tilted	Spray water	Splash water	Jet water	Strong jet of water	Temporary immersion	Lasting immersion	100 bar, 16 l/min., 80 °C
IEC 529 DIN 40050		IP...0	IP...1	IP...2	IP...3	IP...4	IP...5	IP...6	IP...7	IP...8	IP...9K
<p>IP 0... No protection</p>	IP 00										
<p>IP 1... Size of foreign body ≥ 50 mm Ø</p>	IP 10	IP 11	IP 12								
<p>IP 2... Size of foreign body ≥ 12 mm Ø</p>	IP 20	IP 21	IP 22	IP 23							
<p>IP 3... Size of foreign body ≥ 2.5 mm Ø</p>	IP 30	IP 31	IP 32	IP 33	IP 34						
<p>IP 4... Size of foreign body ≥ 1 mm Ø</p>	IP 40	IP 41	IP 42	IP 43	IP 44						
<p>IP 5... Dust-protected</p>	IP 50			IP 53	IP 54	IP 55	IP 56				
<p>IP 6... Dust-proof</p>	IP 60					IP 65	IP 66	IP 67	IP 68	IP 69K	



Explosion protection according to ATEX

ATEX Directive 94/9

The directive 94/9/EC in the European Union is the framework for approximation of the laws of the Member States concerning equipment and protective systems for use in potentially explosive atmospheres. Generally called ATEX (for "Atmosphère explosible"), this directive was implemented in Germany with the 11th Ordinance of the Equipment and Product Safety Act ("Explosion Protection Regulation"/11th BPSGV). Thus, there exist detailed rules for the marketing of new equipment and protective systems for use in hazardous locations. In accordance with the regulations of the directive, products are classified into equipment groups and categories.

Equipment groups

Equipment group I

Encompasses equipment for use in underground mining, including surface equipment.

Equipment group II

Encompasses equipment for use in surface operations and is subdivided into categories 1–3.

Categories and criteria

Category 1 – Very high safety measures

Equipment for use in areas (zones) in which explosive atmospheres are present continuously, long-term or frequently. Even for rarely occurring problems, explosion protection must be guaranteed. This category corresponds to Zones 0 for gases, vapors and mists, as well as Zones 20 for dust environments, where an explosive atmosphere occurs continuously, long-term or frequently in the form of a cloud of combustible dust in the air.

The conditions of Zones 0 and 20 might also occur inside boxes, pipe lines and equipment.

Category 2 – High safety measures

Equipment for use in areas (zones) in which explosive atmospheres only occasionally occur. Explosion protection must also be guaranteed for frequently occurring equipment problems. This category corresponds to Zones 1 for gases, vapors and mists, as well as Zones 21 for dust environments, where an explosive atmosphere occurs occasionally in the form of a cloud of combustible dust in the air under normal operation. This zone can, for example, include areas in the immediate vicinity of e.g., powder filling and emptying points and areas where dust deposits occur and in areas of normal operation give rise occasionally to an explosive concentration of combustible dust when mixed with air.

Category 3 – Normal safety measures

Equipment for use in areas (zones) in which explosive atmospheres are not expected to occur. However, in the event that an explosive atmosphere does occur, it occurs only very rarely and only temporarily. Under normal operation, category 3 equipment must guarantee the required safety measures.

The corresponding zones are Zone 2 for gases, vapors and mists, as well as Zone 22 for areas in which under normal operation it is not expected that an explosive atmosphere in the form of a cloud of combustible dust in air occurs and if it does, then only briefly. This can include areas around dust containing instruments, protective systems and components in which dust can escape due to lack of tightness and cause dust deposits.

Equipment group II						
Equipment for use in other hazardous areas						
	Category 1		Category 2		Category 3	
Danger	Constant, frequent or over a long period		Occasional		Seldom and over a short period	
Requirements	Very high safety		High safety		Normal safety	
Zone	Zone 0	Zone 20	Zone 1	Zone 21	Zone 2	Zone 22
Substance group	G	D	G	D	G	D

G = Gas, D = Dust.

Certificate

After a test body for a device has ensured compliance with the basic safety requirements, it generates a test report. This test report is the basis for a certificate authority (notified body) to issue an EC type-examination certificate.

The CE and ATEX symbols may only be attached to the product when yet another certificate of a notified body per Directive 97/9 concerning the quality assurance of the production of the products has also been granted for the corresponding product group and when the manufacturer has issued a conformity declaration concerning the conformity of the products with the construction type treated in the EC type-examination certificate.

Principles of explosion protection

To establish uniform standards in the determination of protective measures, flammable liquids and gases are divided into explosion groups and temperature classes based on their explosion-relevant properties.

Explosive groups

Gases and vapors are classified into three explosive groups (IIA, IIB and IIC) based on their specific flammability. The danger increases from explosion group IIA to IIC (the higher IIC explosion group always includes the lower IIB and IIA groups).

Temperature classes

To help plan for an installation, 6 temperature classes (T1 to T6) have been established for the approved surface temperatures. Depending on their respective ignition temperatures, certain flammable gases and vapors can be classified under these temperature classes. For the temperature classes, the following maximum allowable surface temperatures are valid for equipment (the higher temperature classes encompass the lower classes, e.g., T6 includes the lower temperature classes T5 to T1):

Class	Max. surface temperature		
	T1	450 °C	T4
T2	300 °C	T5	100 °C
T3	200 °C	T6	85 °C

Types of flammable protection

Technical means must be used to ensure that no ignition source can take effect according to the classification of a given explosive mixture (gap width, temperature class). There are several technical possibilities to achieve explosion protection of an electrical device. The types of flammable protection are listed in the table. On the explosive identification label of a device, the type of flammable protection accorded to the device is indicated by the initial letters of the type of flammable protection.

Flammable protection	Description
Flameproof Encapsulation (d (drive enclosure))	The components that could trigger ignition are installed in an enclosure that withstands the explosion pressure. The openings of the enclosure are designed such that an outward transmission of the explosion is prevented.
Enhanced safety (e (enhanced safety))	The development of sparks, electric arcs, or impermissible temperatures that could function as a source of ignition, is prevented by additional measures and an increased degree of safety.
Pressurized apparatus (p (pressurization, purging))	The device enclosure is filled with a protective gas. An excess pressure is maintained so that an explosive gas mixture cannot reach the possible ignition sources arranged in the interior of the enclosure. If necessary, gas flows continuously through the enclosure.
Intrinsic safety (i (intrinsic safety))	The supply of the electric equipment is led through a safety barrier that limits current and voltage to such an extent that the minimum ignition energy and ignition temperature of an explosive mixture is not reached.
Oil immersion (o (oil immersion))	The parts of the electric equipment from which an ignition can arise are immersed in a protective liquid (mostly oil).
Sand encasing (q (quartz filled))	The equipment is filled with fine-grained sand. A possible electric arc is cooled so much that the ignition of an explosive mixture is impossible. The surface temperature must not exceed the limit value.
Molded encapsulation (m (molded))	The parts of the electric equipment that can create ignition sources are embedded in casting compound so that an electric arc cannot pass through to an explosive mixture outside the casing.
Ignition protection methods (n (non-incendive, non-sparking))	In normal operation and with defined errors, there is no risk of ignition from the electric equipment.

All data without guarantee

Part no.	Model name	Page
1016857	IH06-02BPO-VT1	C-151
1017405	MQ10-60APS-KPO	E-246
1026614	MM18-00A-N-ZCO	E-238
1029861	MM18-00APS-ZCO	E-229
1029950	MM12-90APS-ZCO	E-228
1029951	MM12-90APS-ZU0	E-228
1029952	MM18-00APS-ZU0	E-229
1040026	MM12-60ANS-ZUK	E-228
1040027	MM08-60APS-ZUK	E-228
1040029	MM18-70APS-ZUK	E-229
1040065	MM12-60APO-ZUK	E-228
1040066	MM08-60ANS-ZUK	E-228
1040067	MM08-60APS-ZTK	E-228
1040068	MM08-60ANS-ZTK	E-228
1040069	MM12-60APS-ZUK	E-228
1040070	MM12-60APS-ZCK	E-228
1040071	MM12-60ANS-ZCK	E-228
1040072	MM18-70APS-ZCK	E-229
1040073	MM18-70ANS-ZCK	E-229
1040085	MM18-70ANS-ZUK	E-229
1040731	IME12-02BPSZC0K	C-58
1040732	IME12-02BPSZC0S	C-58
1040733	IME12-02BPSZW2K	C-58
1040734	IME12-02BPSZW2S	C-58
1040735	IME12-02BPOZC0K	C-58
1040736	IME12-02BPOZC0S	C-58
1040737	IME12-02BPOZW2K	C-58
1040738	IME12-02BPOZW2S	C-58
1040739	IME12-02BNSZC0K	C-58
1040740	IME12-02BNSZC0S	C-58
1040741	IME12-02BNSZW2K	C-58
1040742	IME12-02BNSZW2S	C-58
1040743	IME12-02BNOZC0S	C-58
1040744	IME12-02BNOZC0K	C-58
1040745	IME12-02BNOZW2K	C-58
1040746	IME12-02BNOZW2S	C-58
1040747	IME12-04NPSZC0K	C-59
1040748	IME12-04NPSZC0S	C-59
1040749	IME12-04NPSZW2K	C-59
1040750	IME12-04NPSZW2S	C-59
1040751	IME12-04NPOZC0K	C-59
1040752	IME12-04NPOZC0S	C-59
1040753	IME12-04NPOZW2K	C-59
1040754	IME12-04NPOZW2S	C-59
1040755	IME12-04NNSZC0K	C-59
1040756	IME12-04NNSZC0S	C-59
1040757	IME12-04NNSZW2S	C-59
1040758	IME12-04NNSZW2K	C-59
1040759	IME12-04NNOZC0K	C-59
1040760	IME12-04NNOZC0S	C-59
1040761	IME12-04NNOZW2K	C-59
1040762	IME12-04NNOZW2S	C-59
1040763	IME12-04BPSZC0K	C-58
1040764	IME12-04BPSZC0S	C-58
1040765	IME12-04BPSZW2K	C-58
1040766	IME12-04BPSZW2S	C-58
1040767	IME12-04BPOZC0K	C-58
1040768	IME12-04BPOZC0S	C-58

Part no.	Model name	Page
1040769	IME12-04BPOZW2K	C-58
1040770	IME12-04BPOZW2S	C-58
1040771	IME12-04BNSZC0K	C-58
1040772	IME12-04BNSZC0S	C-58
1040773	IME12-04BNSZW2K	C-58
1040774	IME12-04BNSZW2S	C-58
1040775	IME12-04BNOZC0K	C-58
1040776	IME12-04BNOZC0S	C-58
1040777	IME12-04BNOZW2K	C-58
1040778	IME12-04BNOZW2S	C-58
1040779	IME12-08NPSZC0K	C-59
1040780	IME12-08NPSZC0S	C-59
1040781	IME12-08NPSZW2K	C-59
1040782	IME12-08NPSZW2S	C-59
1040783	IME12-08NPOZC0K	C-59
1040784	IME12-08NPOZC0S	C-59
1040785	IME12-08NPOZW2K	C-59
1040786	IME12-08NPOZW2S	C-59
1040787	IME12-08NNSZC0K	C-59
1040788	IME12-08NNSZC0S	C-59
1040789	IME12-08NNSZW2K	C-59
1040790	IME12-08NNSZW2S	C-59
1040791	IME12-08NNOZC0K	C-59
1040792	IME12-08NNOZW2K	C-59
1040793	IME12-08NNOZW2S	C-59
1040826	IME12-08NNOZC0S	C-59
1040837	IME08-1B5PSZT0K	C-40
1040838	IME08-1B5PSZT0S	C-40
1040839	IME08-1B5PSZW2K	C-40
1040840	IME08-1B5PSZW2S	C-40
1040841	IME08-1B5POZT0K	C-40
1040842	IME08-1B5POZT0S	C-40
1040843	IME08-1B5POZW2K	C-40
1040844	IME08-1B5POZW2S	C-40
1040845	IME08-1B5NSZT0K	C-40
1040846	IME08-1B5NSZT0S	C-40
1040847	IME08-1B5NSZW2K	C-40
1040848	IME08-1B5NSZW2S	C-40
1040849	IME08-1B5NOZT0K	C-40
1040850	IME08-1B5NOZT0S	C-40
1040851	IME08-1B5NOZW2K	C-40
1040852	IME08-1B5NOZW2S	C-40
1040853	IME08-2N5PSZT0K	C-41
1040854	IME08-2N5PSZT0S	C-41
1040855	IME08-2N5PSZW2K	C-41
1040856	IME08-2N5PSZW2S	C-41
1040857	IME08-2N5POZT0K	C-41
1040858	IME08-2N5POZT0S	C-41
1040859	IME08-2N5POZW2K	C-41
1040860	IME08-2N5POZW2S	C-41
1040861	IME08-2N5NSZT0K	C-41
1040862	IME08-2N5NSZT0S	C-41
1040863	IME08-2N5NSZW2K	C-41
1040864	IME08-2N5NSZW2S	C-41
1040865	IME08-2N5NOZT0K	C-41
1040866	IME08-2N5NOZT0S	C-41
1040867	IME08-2N5NOZW2K	C-41
1040868	IME08-2N5NOZW2S	C-41

Part no.	Model name	Page
1040869	IME08-02BPSZT0K	C-40
1040870	IME08-02BPSZT0S	C-40
1040871	IME08-02BPSZW2K	C-40
1040872	IME08-02BPSZW2S	C-40
1040873	IME08-02BPOZT0K	C-40
1040874	IME08-02BPOZT0S	C-40
1040875	IME08-02BPOZW2K	C-40
1040876	IME08-02BPOZW2S	C-40
1040877	IME08-02BNSZT0K	C-40
1040878	IME08-02BNSZT0S	C-40
1040879	IME08-02BNSZW2K	C-40
1040880	IME08-02BNSZW2S	C-40
1040881	IME08-02BNOZT0K	C-40
1040882	IME08-02BNOZT0S	C-40
1040883	IME08-02BNOZW2K	C-40
1040884	IME08-02BNOZW2S	C-40
1040885	IME08-04NPSZT0K	C-41
1040886	IME08-04NPSZT0S	C-41
1040887	IME08-04NPSZW2K	C-41
1040888	IME08-04NPSZW2S	C-41
1040889	IME08-04NPOZT0K	C-41
1040890	IME08-04NPOZT0S	C-41
1040891	IME08-04NPOZW2K	C-41
1040892	IME08-04NPOZW2S	C-41
1040893	IME08-04NNSZT0K	C-41
1040894	IME08-04NNSZT0S	C-41
1040895	IME08-04NNSZW2K	C-41
1040896	IME08-04NNSZW2S	C-41
1040897	IME08-04NNOZT0K	C-41
1040898	IME08-04NNOZT0S	C-41
1040899	IME08-04NNOZW2K	C-41
1040900	IME08-04NNOZW2S	C-41
1040933	IME18-05BPSZC0K	C-78
1040934	IME18-05BPSZC0S	C-78
1040935	IME18-05BPSZW2K	C-78
1040936	IME18-05BPSZW2S	C-78
1040937	IME18-05BPOZC0K	C-78
1040938	IME18-05BPOZC0S	C-78
1040939	IME18-05BPOZW2K	C-78
1040940	IME18-05BPOZW2S	C-78
1040941	IME18-05BNSZC0K	C-78
1040942	IME18-05BNSZC0S	C-78
1040943	IME18-05BNSZW2K	C-78
1040944	IME18-05BNSZW2S	C-78
1040945	IME18-05BNOZC0K	C-78
1040946	IME18-05BNOZC0S	C-78
1040947	IME18-05BNOZW2K	C-78
1040948	IME18-05BNOZW2S	C-78
1040949	IME18-08NPSZC0K	C-79
1040950	IME18-08NPSZC0S	C-79
1040951	IME18-08NPSZW2K	C-79
1040952	IME18-08NPSZW2S	C-79
1040953	IME18-08NPOZC0K	C-79
1040954	IME18-08NPOZC0S	C-79
1040955	IME18-08NPOZW2K	C-79
1040956	IME18-08NPOZW2S	C-79
1040957	IME18-08NNSZC0K	C-79
1040958	IME18-08NNSZC0S	C-79

Part no.	Model name	Page
1040959	IME18-08NNSZW2K	C-79
1040960	IME18-08NNSZW2S	C-79
1040961	IME18-08NNOZC0K	C-79
1040962	IME18-08NNOZC0S	C-79
1040964	IME18-08NNOZW2S	C-79
1040965	IME18-08BPSZC0K	C-78
1040966	IME18-08BPSZC0S	C-78
1040967	IME18-08BPSZW2K	C-78
1040968	IME18-08BPSZW2S	C-78
1040969	IME18-08BPOZC0K	C-78
1040970	IME18-08BPOZC0S	C-78
1040971	IME18-08BPOZW2K	C-78
1040972	IME18-08BPOZW2S	C-78
1040973	IME18-08BNSZC0K	C-78
1040974	IME18-08BNSZC0S	C-78
1040975	IME18-08BNSZW2K	C-78
1040976	IME18-08BNSZW2S	C-78
1040977	IME18-08BNOZC0K	C-78
1040978	IME18-08BNOZC0S	C-78
1040979	IME18-08BNOZW2K	C-78
1040980	IME18-08BNOZW2S	C-78
1040981	IME18-12NPSZC0K	C-79
1040982	IME18-12NPSZC0S	C-79
1040983	IME18-12NPSZW2K	C-79
1040984	IME18-12NPSZW2S	C-79
1040985	IME18-12NPOZC0K	C-79
1040986	IME18-12NPOZC0S	C-79
1040987	IME18-12NPOZW2K	C-79
1040988	IME18-12NPOZW2S	C-79
1040989	IME18-12NNSZC0K	C-79
1040990	IME18-12NNSZC0S	C-79
1040991	IME18-12NNSZW2K	C-79
1040992	IME18-12NNSZW2S	C-79
1040993	IME18-12NNOZC0K	C-79
1040994	IME18-12NNOZC0S	C-79
1040995	IME18-12NNOZW2K	C-79
1040996	IME18-12NNOZW2S	C-79
1040997	IME30-10BPSZC0K	C-92
1040998	IME30-10BPSZC0S	C-92
1040999	IME30-10BPSZW2K	C-92
1041000	IME30-10BPSZW2S	C-92
1041001	IME30-10BPOZC0K	C-92
1041002	IME30-10BPOZC0S	C-92
1041003	IME30-10BPOZW2K	C-92
1041004	IME30-10BPOZW2S	C-92
1041005	IME30-10BNSZC0K	C-92
1041006	IME30-10BNSZC0S	C-92
1041007	IME30-10BNSZW2K	C-92
1041008	IME30-10BNSZW2S	C-92
1041009	IME30-10BNOZC0S	C-92
1041010	IME30-10BNOZC0K	C-92
1041011	IME30-10BNOZW2K	C-92
1041012	IME30-10BNOZW2S	C-92
1041013	IME30-15NPSZC0K	C-93
1041014	IME30-15NPSZC0S	C-93
1041015	IME30-15NPSZW2K	C-93
1041016	IME30-15NPSZW2S	C-93
1041017	IME30-15NPOZC0K	C-93

Part no.	Model name	Page
1041018	IME30-15NPOZC0S	C-93
1041019	IME30-15NPOZW2K	C-93
1041020	IME30-15NPOZW2S	C-93
1041021	IME30-15NNSZC0K	C-93
1041022	IME30-15NNSZC0S	C-93
1041023	IME30-15NNSZW2K	C-93
1041024	IME30-15NNSZW2S	C-93
1041025	IME30-15NNOZC0K	C-93
1041026	IME30-15NNOZC0S	C-93
1041027	IME30-15NNOZW2K	C-93
1041028	IME30-15NNOZW2S	C-93
1041029	IME30-15BPSZC0K	C-92
1041030	IME30-15BPSZC0S	C-92
1041031	IME30-15BPSZW2K	C-92
1041032	IME30-15BPSZW2S	C-92
1041033	IME30-15BPOZC0K	C-92
1041034	IME30-15BPOZC0S	C-92
1041035	IME30-15BPOZW2K	C-92
1041036	IME30-15BPOZW2S	C-92
1041037	IME30-15BNSZC0K	C-92
1041038	IME30-15BNSZC0S	C-92
1041039	IME30-15BNSZW2K	C-92
1041040	IME30-15BNSZW2S	C-92
1041041	IME30-15BNOZC0K	C-92
1041042	IME30-15BNOZC0S	C-92
1041043	IME30-15BNOZW2K	C-92
1041044	IME30-15BNOZW2S	C-92
1041045	IME30-20NPSZC0K	C-93
1041046	IME30-20NPSZC0S	C-93
1041047	IME30-20NPSZW2K	C-93
1041048	IME30-20NPSZW2S	C-93
1041049	IME30-20NPOZC0K	C-93
1041050	IME30-20NPOZC0S	C-93
1041051	IME30-20NPOZW2K	C-93
1041052	IME30-20NPOZW2S	C-93
1041053	IME30-20NNSZC0K	C-93
1041054	IME30-20NNSZC0S	C-93
1041055	IME30-20NNSZW2K	C-93
1041056	IME30-20NNSZW2S	C-93
1041057	IME30-20NNOZC0K	C-93
1041058	IME30-20NNOZC0S	C-93
1041059	IME30-20NNOZW2K	C-93
1041060	IME30-20NNOZW2S	C-93
1042973	IME12-04BPSZT0K	C-58
1043660	IME12-04NPPZC0K	C-59
1044127	IME18-12NPPZC0S	C-79
1046743	IME18-05BPPZC0S	C-78
1046761	MM12-90A-N-ZUD	E-238
1046894	IME18-08NPPZC0S	C-79
1047255	MM18-70APO-ZCK	E-229
1050765	MM18-70APS-VCK	E-229
1051013	MM12-90ANS-ZU0	E-228
1051127	IME08-02BNSZC0S	C-40
1051205	IME08-02BPSZC0S	C-40
1051207	IME08-02BPOZC0S	C-40
1051208	IME08-04NPOZC0S	C-41
1051209	IME08-04NPSZC0S	C-41
1055428	IQ12-04BPSKW2S	C-176

Part no.	Model name	Page
1055429	IQ12-04BP0KW2S	C-176
1055430	IQ12-04BNSKW2S	C-176
1055431	IQ12-04BN0KW2S	C-176
1055432	IQ12-04BPSKT0S	C-176
1055433	IQ12-04BP0KT0S	C-176
1055434	IQ12-04BNSKT0S	C-176
1055435	IQ12-04BN0KT0S	C-176
1055436	IQ12-08NPSKW2S	C-176
1055437	IQ12-08NP0KW2S	C-176
1055438	IQ12-08NNSKW2S	C-176
1055439	IQ12-08NN0KW2S	C-176
1055440	IQ12-08NPSKT0S	C-176
1055441	IQ12-08NP0KT0S	C-176
1055442	IQ12-08NNSKT0S	C-176
1055443	IQ12-08NN0KT0S	C-176
1055444	IQ12-04BPPKW2S	C-176
1055445	IQ12-04BNPKW2S	C-176
1055447	IQ10-03BPSKW2S	C-170
1055449	IQ10-03BP0KW2S	C-170
1055450	IQ10-03BNSKW2S	C-170
1055452	IQ10-03BN0KW2S	C-170
1055453	IQ10-03BPSKT0S	C-170
1055454	IQ10-03BP0KT0S	C-170
1055455	IQ10-03BNSKT0S	C-170
1055456	IQ10-03BN0KT0S	C-170
1055457	IQ10-06NPSKW2S	C-170
1055458	IQ10-06NP0KW2S	C-170
1055459	IQ10-06NNSKW2S	C-170
1055460	IQ10-06NN0KW2S	C-170
1055461	IQ10-06NPSKT0S	C-170
1055462	IQ10-06NP0KT0S	C-170
1055463	IQ10-06NNSKT0S	C-170
1055464	IQ10-06NN0KT0S	C-170
1055465	IQ10-03BPPKW2S	C-170
1055466	IQ10-03BNPKW2S	C-170
1055490	IQ08-02BPSKW2S	C-158
1055491	IQ08-02BP0KW2S	C-158
1055492	IQ08-02BNSKW2S	C-158
1055493	IQ08-02BN0KW2S	C-158
1055494	IQ08-02BPSKT0S	C-158
1055495	IQ08-02BP0KT0S	C-158
1055496	IQ08-02BNSKT0S	C-158
1055497	IQ08-02BN0KT0S	C-158
1055498	IQ08-04NPSKW2S	C-159
1055499	IQ08-04NP0KW2S	C-159
1055500	IQ08-04NNSKW2S	C-159
1055501	IQ08-04NN0KW2S	C-159
1055502	IQ08-04NPSKT0S	C-159
1055503	IQ08-04NP0KT0S	C-159
1055504	IQ08-04NNSKT0S	C-159
1055505	IQ08-04NN0KT0S	C-159
1056423	IME12-04BPPZW2K	C-58
1056708	IME18-08BPPZC0S	C-78
1057551	IME30-15BPPZW2K	C-92
2043770	BEF-EA-CM30	G-260
2051477	BEF-KH-M08	G-260
2051478	BEF-KHF-M08	G-260
2051479	BEF-KH-M12	G-260

Part no.	Model name	Page
2051480	BEF-KHF-M12	G-260
2051481	BEF-KH-M18	G-260
2051482	BEF-KHF-M18	G-260
2051611	BEF-KHS-N05	G-263
2051612	BEF-KHS-N06	G-263
2051621	BEF-KHS-N05N	G-263
2051622	BEF-KHS-N06N	G-263
2062372	BEF-KHS-N10	G-263
2062373	BEF-KHS-N10N	G-263
4056052	BEF-MS12L-A	G-263
4056053	BEF-MS12L-B	G-263
4056054	BEF-MS12G-A	G-263
4056055	BEF-MS12G-B	G-263
4056056	BEF-MS12Z-A	G-263
4056057	BEF-MS12Z-B	G-263
4058912	BEF-MS12L-NA	G-263
4058913	BEF-MS12L-NB	G-263
4058914	BEF-MS12G-NA	G-263
4058915	BEF-MS12G-NB	G-263
4058916	BEF-MS12Z-NA	G-263
4058917	BEF-MS12Z-NB	G-263
5308445	BEF-WN-M30	G-258
5308446	BEF-WN-M18	G-258
5308447	BEF-WN-M12	G-258
5312973	BEF-WN-M18-ST02	G-260
5320947	BEF-WN-M18N	G-258
5320948	BEF-WG-M18N	G-258
5320949	BEF-WN-M12N	G-258
5320950	BEF-WG-M12N	G-258
5321721	BEF-WN-M08	G-258
5321722	BEF-WG-M08	G-258
5321869	BEF-WG-M12	G-258
5321870	BEF-WG-M18	G-258
5321871	BEF-WG-M30	G-258
5321878	BEF-RMC-D12	G-263
5322626	BEF-KHS-KH3	G-263
5322627	BEF-KHS-KH3N	G-263
6007302	DOS-1204-G	G-277
6007303	DOS-1204-W	G-277
6008489	DOL-0803-W02M	G-267
6008899	DOL-1205-G02M	G-268
6009382	DOL-1204-G02M	G-267
6009383	DOL-1204-W02M	G-267
6009719	DOS-1205-G	G-277
6009720	DOS-1205-W	G-277
6009866	DOL-1204-G05M	G-267
6009867	DOL-1204-W05M	G-267
6009868	DOL-1205-G05M	G-268
6009870	DOL-0804-G02M	G-267
6009871	DOL-0804-W02M	G-267
6009872	DOL-0804-G05M	G-267
6009873	DOL-0804-W05M	G-267
6009932	STE-1204-G	G-277
6009974	DOS-0804-G	G-277
6009975	DOS-0804-W	G-277
6010541	DOL-1204-W10M	G-267
6010543	DOL-1204-G10M	G-267
6010544	DOL-1205-G10M	G-268

Part no.	Model name	Page
6010754	DOL-0804-G10M	G-267
6010755	DOL-0804-W10M	G-267
6010785	DOL-0803-G02M	G-267
6011591	IM05-0B8PS-ZW1	C-34
6020110	IM05-0B8PS-ZT1	C-34
6020111	IM08-1B5PS-ZWK	C-48
6020112	IM08-1B5PS-ZTK	C-48
6020113	IH04-0B8PS-VW1	C-144
6020114	IH04-0B8PS-VT1	C-144
6020136	CM18-08BPP-KW1	D-204
6020141	IH03-0B6PS-VU1	C-144
6020142	IH03-0B6NS-VU1	C-144
6020143	IH03-0B6PO-VU1	C-144
6020145	IM04-0B6PS-ZU1	C-34
6020146	IM04-0B6NS-ZU1	C-34
6020147	IM04-0B6PO-ZU1	C-34
6020149	IH04-0B8NS-VW1	C-144
6020152	IH04-0B8NS-VT1	C-144
6020155	IM05-0B8NS-ZW1	C-34
6020157	IM05-0B8NO-ZW1	C-34
6020158	IM05-0B8NS-ZT1	C-34
6020159	IM05-0B8PO-ZT1	C-34
6020161	IQ05-0B8PS-ZU1	C-158
6020162	IQ05-0B8NS-ZU1	C-158
6020163	IQ05-0B8PO-ZU1	C-158
6020165	IH06-1B5PS-VWK	C-150
6020166	IH06-1B5NS-VWK	C-150
6020167	IH06-1B5PO-VWK	C-150
6020169	IH06-1B5PS-VTK	C-150
6020170	IH06-1B5NS-VTK	C-150
6020171	IH06-1B5PO-VTK	C-150
6020173	IM08-1B5NS-ZWK	C-48
6020174	IM08-1B5PO-ZWK	C-48
6020176	IM08-1B5NS-ZTK	C-48
6020177	IM08-1B5PO-ZTK	C-48
6020310	IM12-02BDS-ZW1	C-52
6020311	IM12-02BDO-ZW1	C-52
6020312	IM12-02BDS-ZC1	C-52
6020314	IM12-04NDS-ZW1	C-52
6020315	IM12-04NDO-ZW1	C-52
6020316	IM12-04NDS-ZC1	C-52
6020317	IM12-04NDO-ZC1	C-52
6020318	IM18-05BDS-ZW1	C-72
6020320	IM18-05BDS-ZC1	C-72
6020321	IM18-05BDO-ZC1	C-72
6020322	IM18-08NDS-ZW1	C-72
6020324	IM18-08NDS-ZC1	C-72
6020326	IM30-10BDS-ZW1	C-86
6020328	IM30-10BDS-ZC1	C-86
6020330	IM30-15NDS-ZW1	C-86
6020332	IM30-15NDS-ZC1	C-86
6020388	CM18-08BPP-KC1	D-204
6020389	CM18-12NPP-KW1	D-204
6020410	CM18-12NPP-KC1	D-204
6020473	CM30-16BPP-KW1	D-204
6020475	CM30-16BPP-KC1	D-204
6020476	CM30-25NPP-KW1	D-204
6020477	CM30-25NPP-KC1	D-204

Part no.	Model name	Page
6020478	CQ35-25NPP-KW1	D-216
6020479	CQ35-25NPP-KC1	D-216
6021123	IM08-01B-N-ZW0	C-126
6021124	IM12-02B-N-ZW0	C-126
6021125	IM12-04N-N-ZW0	C-126
6021126	IM18-05B-N-ZW0	C-126
6021127	IM18-08N-N-ZW0	C-126
6021128	IM30-10B-N-ZW0	C-126
6021129	IM30-15N-N-ZW0	C-126
6021455	CM18-08BNP-KW1	D-204
6021456	CM18-08BNP-KC1	D-204
6021457	CM18-12NNP-KW1	D-204
6021458	CM18-12NNP-KC1	D-204
6021459	CM30-16BNP-KW1	D-204
6021460	CM30-16BNP-KC1	D-204
6021461	CM30-25NNP-KW1	D-204
6021462	CM30-25NNP-KC1	D-204
6021463	CQ35-25NNP-KW1	D-216
6021464	CQ35-25NNP-KC1	D-216
6022009	DOL-0803-G05M	G-267
6022010	DOL-0803-W05M	G-267
6022011	DOL-0803-G10M	G-267
6022012	DOL-0803-W10M	G-267
6022082	STE-1205-W	G-277
6022083	STE-1205-G	G-277
6022084	STE-1204-W	G-277
6022565	DSL-1204-G0M6	G-271
6022567	DSL-1204-G02M	G-271
6022569	DSL-1204-G05M	G-271
6022570	DSL-8203-G0M6	G-270
6022571	DSL-8204-G0M6	G-271
6022572	DSL-8203-G02M	G-270
6022573	DSL-8204-G02M	G-271
6025566	IM30-22BPS-ZCK	C-101
6025568	IM30-22BPO-ZCK	C-101
6025569	IM18-12BPS-ZCK	C-101
6025574	IM08-03BPS-ZT1	C-100
6025814	IQ40-15BPP-KK1	C-186
6025815	IQ40-20NPP-KK1	C-186
6025816	IQ40-15BAP-KK1	C-187
6025817	IQ40-15BDP-KK1	C-186
6025874	IH06-02BPS-VWK	C-151
6025875	IH06-02BNS-VWK	C-151
6025877	IH06-02BPS-VTK	C-151
6025878	IH06-02BNS-VTK	C-151
6025879	IH06-02BPO-VTK	C-151
6025880	IH06-04NPS-VWK	C-151
6025881	IH06-04NNS-VWK	C-151
6025882	IH06-04NPS-VTK	C-151
6025883	IH06-04NNS-VTK	C-151
6025884	IH06-04NPO-VTK	C-151
6025888	DOL-0803-G02MC	G-267
6025889	DOL-0803-G05MC	G-267
6025890	DOL-0803-G10MC	G-267
6025891	DOL-0803-W02MC	G-267
6025892	DOL-0803-W05MC	G-267
6025893	DOL-0803-W10MC	G-267
6025894	DOL-0804-G02MC	G-267

Part no.	Model name	Page
6025895	DOL-0804-G05MC	G-267
6025896	DOL-0804-G10MC	G-267
6025897	DOL-0804-W02MC	G-267
6025898	DOL-0804-W05MC	G-267
6025899	DOL-0804-W10MC	G-267
6025900	DOL-1204-G02MC	G-267
6025901	DOL-1204-G05MC	G-267
6025902	DOL-1204-G10MC	G-267
6025903	DOL-1204-W02MC	G-267
6025904	DOL-1204-W05MC	G-267
6025905	DOL-1204-W10MC	G-267
6025906	DOL-1205-G02MC	G-268
6025907	DOL-1205-G05MC	G-268
6025908	DOL-1205-G10MC	G-268
6025914	DSL-8203-G0M6C	G-270
6025915	DSL-8203-G02MC	G-270
6025916	DSL-8203-B0M6C	G-270
6025917	DSL-8203-B02MC	G-270
6025918	DSL-8204-G0M6C	G-271
6025919	DSL-8204-G02MC	G-271
6025920	DSL-8204-B0M6C	G-271
6025921	DSL-8204-B02MC	G-271
6025926	DSL-1204-G0M6C	G-271
6025927	DSL-1204-G02MC	G-271
6025931	DSL-1205-G02MC	G-271
6026194	CM18-08BNP-TWO	D-212
6026195	CM18-08BPP-TWO	D-212
6026473	IQ80-50BPP-KCO	C-192
6027505	IM08-03BPS-ZW1	C-100
6027506	IM08-06NPS-ZW1	C-100
6027507	IM08-06NNS-ZW1	C-100
6027508	IM08-06NPS-ZT1	C-100
6027509	IM12-06BPS-ZW1	C-100
6027510	IM12-06BPO-ZW1	C-100
6027511	IM12-06BPS-ZC1	C-100
6027512	IM12-10NPS-ZW1	C-100
6027513	IM12-10NNS-ZW1	C-100
6027514	IM12-10NPS-ZC1	C-100
6027515	IM18-12BPS-ZW1	C-101
6027516	IM18-12BNS-ZW1	C-101
6027517	IM18-12BPS-ZC1	C-101
6027518	IM18-20NPS-ZW1	C-101
6027519	IM18-20NPS-ZC1	C-101
6027520	IM30-22BNS-ZW1	C-101
6027521	IM30-22BPS-ZC1	C-101
6027522	IM30-40NPS-ZC1	C-101
6027572	IM12-06BPS-NC1	C-120
6027573	IM12-06BNS-NC1	C-120
6027574	IM12-06BPO-NC1	C-120
6027575	IM12-10NPS-NC1	C-120
6027576	IM12-10NNS-NC1	C-120
6027577	IM18-10BPS-NC1	C-120
6027578	IM18-10BNS-NC1	C-120
6027579	IM18-10BPO-NC1	C-120
6027580	IM18-20NPS-NC1	C-120
6027581	IM18-20NNS-NC1	C-120
6027582	IM30-20BPS-NC1	C-120
6027583	IM30-20BNS-NC1	C-120

Part no.	Model name	Page
6027584	IM30-40NPS-NC1	C-120
6027585	IM30-40NNS-NC1	C-120
6027944	DOL-1204-L05M	G-268
6027945	DOL-1204-L02M	G-268
6027946	DOL-1204-L10M	G-268
6028074	IM08-03BNS-ZW1	C-100
6028093	IM18-20NNS-ZW1	C-101
6028128	DOL-1204-G02MN	G-274
6028129	DOL-1204-W02MN	G-274
6028130	DOL-1204-G05MN	G-274
6028131	DOL-1204-W05MN	G-274
6028132	DOL-1204-G10MN	G-274
6028133	DOL-1204-W10MN	G-274
6028134	DOL-1204-G25MN	G-274
6028135	DOL-1204-W25MN	G-274
6028136	DOL-1204-L02MN	G-274
6028137	DOL-1204-L05MN	G-274
6028138	DOL-1204-L10MN	G-274
6028139	DOL-1204-L25MN	G-274
6028140	DOL-1205-G02MN	G-274
6028141	DOL-1205-G05MN	G-274
6028142	DOL-1205-G10MN	G-274
6028194	DSL-1204-G0M6N	G-275
6028195	DSL-1204-G02MN	G-275
6028196	DSL-1204-G05MN	G-275
6028197	DSL-1204-B0M6N	G-275
6028198	DSL-1204-B02MN	G-275
6028199	DSL-1204-B05MN	G-275
6028357	DOS-1204-GN	G-277
6028358	DOS1204-WN	G-277
6028359	STE-1204-GN	G-277
6028360	STE-1204-TN	G-277
6028411	CM30-16BAP-KW1	D-204
6028413	CM30-25NAP-KW1	D-204
6029280	DSL-1205-G01MC	G-271
6029281	DSL-1205-G1M5C	G-271
6029282	DSL-1205-G05MC	G-271
6030132	CQ28-10NPP-KW1	D-216
6030133	CQ28-10NNP-KW1	D-216
6030524	IM12-06BNS-ZC1	C-100
6030608	DSL-8203-G05MC	G-270
6033033	IM30-22BNS-ZC1	C-101
6033087	IM30-40NNS-ZC1	C-101
6033244	DSL-1204-G01MC	G-271
6033245	DSL-1204-G05MC	G-271
6033664	DOL-0803-G02MN	G-274
6033665	DOL-0803-G05MN	G-274
6033666	DOL-0803-G10MN	G-274
6033667	DOL-0803-W02MN	G-274
6033668	DOL-0803-W05MN	G-274
6033669	DOL-0803-W10MN	G-274
6033670	DOL-0804-G02MN	G-274
6033671	DOL-0804-G05MN	G-274
6033672	DOL-0804-G10MN	G-274
6033673	DOL-0804-W02MN	G-274
6033674	DOL-0804-W05MN	G-274
6033675	DOL-0804-W10MN	G-274
6033698	DSL-1204-G10MC	G-271

Part no.	Model name	Page
6034403	DSL-8204-G05M	G-271
6034404	DSL-8204-G10M	G-271
6034406	DSL-1204-G10M	G-271
6034664	DSL-0804-G0M6	G-271
6034665	DSL-0804-G02M	G-271
6034822	DSL-1204-G1M5	G-271
6035215	IMF12-02BPPVCOS	C-112
6035216	IMF12-02BNPVCOS	C-112
6035217	IMF12-04NPPVCOS	C-112
6035218	IMF12-04NNPVCOS	C-112
6035219	IMF12-04BPPVCOS	C-112
6035220	IMF12-04BNPVCOS	C-112
6035221	IMF12-08NPPVCOS	C-113
6035222	IMF12-08NNPVCOS	C-113
6035223	IMF18-05BPPVCOS	C-113
6035224	IMF18-05BNPVCOS	C-113
6035225	IMF18-08NPPVCOS	C-113
6035226	IMF18-08NNPVCOS	C-113
6035227	IMF18-08BPPVCOS	C-113
6035228	IMF18-08BNPVCOS	C-113
6035229	IMF18-12NPPVCOS	C-113
6035230	IMF18-12NNPVCOS	C-113
6035452	IMF12-02BPSVCOS	C-112
6035453	IMF12-02BNSVCOS	C-112
6035454	IMF12-02BPOVCOS	C-112
6035455	IMF12-02BNOVCOS	C-112
6035456	IMF12-04NPSVCOS	C-112
6035457	IMF12-04NNSVCOS	C-112
6035458	IMF12-04NPOVCOS	C-112
6035459	IMF12-04NNOVCOS	C-112
6035460	IMF12-04BPSVCOS	C-112
6035461	IMF12-04BNSVCOS	C-112
6035462	IMF12-04BPOVCOS	C-112
6035463	IMF12-04BNOVCOS	C-112
6035464	IMF12-08NPSVCOS	C-113
6035465	IMF12-08NNSVCOS	C-113
6035466	IMF12-08NPOVCOS	C-113
6035467	IMF12-08NNOVCOS	C-113
6035468	IMF18-05BPSVCOS	C-113
6035469	IMF18-05BNSVCOS	C-113
6035470	IMF18-05BPOVCOS	C-113
6035471	IMF18-05BNOVCOS	C-113
6035472	IMF18-08NPSVCOS	C-113
6035473	IMF18-08NNSVCOS	C-113
6035474	IMF18-08NPOVCOS	C-113
6035475	IMF18-08NNOVCOS	C-113
6035476	IMF18-08BPSVCOS	C-113
6035477	IMF18-08BNSVCOS	C-113
6035478	IMF18-08BPOVCOS	C-113
6035479	IMF18-08BNOVCOS	C-113
6035480	IMF18-12NPSVCOS	C-113
6035481	IMF18-12NNSVCOS	C-113
6035482	IMF18-12NPOVCOS	C-113
6035483	IMF18-12NNOVCOS	C-113
6036335	DSL-0804-G02MC	G-271
6036384	DOL-1205-G05MAC	G-268
6036385	DOL-1205-G10MAC	G-268
6036472	DOL-0803-G15M	G-267

Part no.	Model name	Page
6036473	DOL-0803-W15M	G-267
6037070	IQ40-20BPSKCOK	C-182
6037071	IQ40-40NPSKCOK	C-182
6037072	IQ40-20BPPKCOK	C-182
6037073	IQ40-40NPPKCOK	C-182
6037322	STE-0803-G	G-277
6037323	STE-0804-G	G-277
6038602	IH03-0B6PS-VR1	C-144
6038954	DSL-1205-G10MC	G-271
6038956	DSL-1205-G15MC	G-271
6038957	DSL-1205-G20MC	G-271
6039087	DSL-0804-G20M	G-271
6039089	DSL-0804-G0M6C	G-271
6039090	DSL-0804-G05MC	G-271
6039181	DSL-8204-G05MC	G-271
6039182	DSL-8204-B05MC	G-271
6039185	DSL-8203-B05MC	G-270
6041095	EN2-2EX-3	G-280
6041096	EN2-2EX-1	G-280
6041751	DOL-1205-W05MAC	G-268
6041752	DOL-1205-W10MAC	G-268
6041782	IMA08-04BE3ZCOK	C-134
6041792	IMA12-06BE3ZCOK	C-134
6041793	IMA18-10BE1ZCOK	C-134
6041794	IMA18-20NE1ZCOK	C-134
6041795	IMA30-20BE1ZCOK	C-135
6041796	IMA30-40NE1ZCOK	C-135
6041997	IM18-20NNS-ZC1	C-101
6042017	IQ04-1B5PSKW2S	C-164
6042018	IQ04-1B5POKW2S	C-164
6042019	IQ04-1B5NSKW2S	C-164
6042020	IQ04-1B5NOKW2S	C-164
6042022	IQ06-03BPSKU2S	C-164
6042023	IQ06-03BP0KU2S	C-164
6042024	IQ06-03BNSKU2S	C-164
6042025	IQ06-03BNOKU2S	C-164
6042043	IQ20-07BPSDPOS	C-164
6042044	IQ20-07BNSDPOS	C-164
6042045	IQ20-07BPPDQOS	C-164
6042046	IQ25-05BPSDU2S	C-164
6042047	IQ25-05BPPDU2S	C-164
6042050	DSL-0804-G1M5	G-271
6042085	IM04-0B6PS-ZR1	C-34
6045178	IH04-0B8PS-VR1	C-144
6049733	IM05-1B5NSVU2S	C-34
6049734	IM05-1B5NOVU2S	C-34
6049735	IM05-1B5PSVU2S	C-34
6049736	IM05-1B5POVU2S	C-34
6049737	IM05-1B5NSVTOS	C-34
6049738	IM05-1B5NOVTOS	C-34
6049739	IM05-1B5PSVTOS	C-34
6049740	IM05-1B5POVTOS	C-34
7900177	IH06-02BPS-VW1	C-151
7900178	IH06-02BNS-VW1	C-151
7900179	IH06-02BPS-VT1	C-151
7900180	IH06-02BNS-VT1	C-151
7900181	IH06-04NPS-VW1	C-151
7900182	IH06-04NNS-VW1	C-151

Part no.	Model name	Page
7900183	IH06-04NPS-VT1	C-151
7900219	IQ40-15BPP-KK0	C-186
7900221	IQ40-20NPP-KK0	C-186
7900227	IQ80-60NPP-KK0	C-192
7900278	MQ10-60APS-KU0	E-246
7900279	MQ10-60ANS-KU0	E-246
7900280	MQ10-60APS-KT0	E-246
7900281	MQ10-60ANS-KT0	E-246
7900286	MM12-60A-N-ZW0	E-238
7900287	MM12-60A-N-ZC0	E-238
7900288	MM18-70A-N-ZW0	E-238
7900289	MM18-70A-N-ZC0	E-238
7901782	MAG-1003-S (M 5.0)	G-266
7901783	MAG-0625-A (M 5.0)	G-266
7901784	MAG-2006-B (M 4.0)	G-266
7901785	MAG-3010-B (M 3.0)	G-266
7901786	MAG-3015-B (M 1.0)	G-266
7902077	DOS-0803-G	G-277
7902078	DOS-0803-W	G-277
7902086	MAG-3515-B (M 2.0)	G-266
7902118	IM12-02BAS-ZU0	C-52
7902119	IM12-02BAO-ZU0	C-52
7902120	IM12-04NAS-ZU0	C-52
7902121	IM12-04NAO-ZU0	C-52
7902122	IM18-05BUS-ZU0	C-72
7902123	IM18-05BUO-ZU0	C-72
7902124	IM18-08NUS-ZU0	C-72
7902125	IM18-08NUO-ZU0	C-72
7902126	IM30-10BUS-ZU0	C-86
7902127	IM30-10BUO-ZU0	C-86
7902128	IM30-15NUS-ZU0	C-86
7902129	IM30-15NUO-ZU0	C-86
7902130	IH20-10NUS-KU0	C-151
7902131	IH20-10NUO-KU0	C-151
7902134	IH34-30NUS-KU0	C-152
7902135	IH34-30NUO-KU0	C-152
7902136	IQ40-15BUP-KK0	C-186
7902137	IQ40-20NUP-KK0	C-186
7902138	IQ80-60NUP-KK0	C-192
7902927	IM12-02BCP-ZW1	C-66
7902928	IM12-02BCP-ZC1	C-66
7902929	IM12-04NCP-ZW1	C-66
7902930	IM12-04NCP-ZC1	C-66



Model name	Part no.	Page
BEF-EA-CM30	2043770	G-260
BEF-KH-M08	2051477	G-260
BEF-KH-M12	2051479	G-260
BEF-KH-M18	2051481	G-260
BEF-KHF-M08	2051478	G-260
BEF-KHF-M12	2051480	G-260
BEF-KHF-M18	2051482	G-260
BEF-KHS-KH3	5322626	G-263
BEF-KHS-KH3N	5322627	G-263
BEF-KHS-N05	2051611	G-263
BEF-KHS-N05N	2051621	G-263
BEF-KHS-N06	2051612	G-263
BEF-KHS-N06N	2051622	G-263
BEF-KHS-N10	2062372	G-263
BEF-KHS-N10N	2062373	G-263
BEF-MS12G-A	4056054	G-263
BEF-MS12G-B	4056055	G-263
BEF-MS12G-NA	4058914	G-263
BEF-MS12G-NB	4058915	G-263
BEF-MS12L-A	4056052	G-263
BEF-MS12L-B	4056053	G-263
BEF-MS12L-NA	4058912	G-263
BEF-MS12L-NB	4058913	G-263
BEF-MS12Z-A	4056056	G-263
BEF-MS12Z-B	4056057	G-263
BEF-MS12Z-NA	4058916	G-263
BEF-MS12Z-NB	4058917	G-263
BEF-RMC-D12	5321878	G-263
BEF-WG-M08	5321722	G-258
BEF-WG-M12	5321869	G-258
BEF-WG-M12N	5320950	G-258
BEF-WG-M18	5321870	G-258
BEF-WG-M18N	5320948	G-258
BEF-WG-M30	5321871	G-258
BEF-WN-M08	5321721	G-258
BEF-WN-M12	5308447	G-258
BEF-WN-M12N	5320949	G-258
BEF-WN-M18	5308446	G-258
BEF-WN-M18-ST02	5312973	G-258
BEF-WN-M18N	5320947	G-260
BEF-WN-M30	5308445	G-258
CM18-08BNP-KC1	6021456	D-204
CM18-08BNP-KW1	6021455	D-204
CM18-08BNP-TW0	6026194	D-212
CM18-08BPP-KC1	6020388	D-204
CM18-08BPP-KW1	6020136	D-204
CM18-08BPP-TW0	6026195	D-212
CM18-12NNP-KC1	6021458	D-204
CM18-12NNP-KW1	6021457	D-204
CM18-12NPP-KC1	6020410	D-204
CM18-12NPP-KW1	6020389	D-204
CM30-16BAP-KW1	6028411	D-204
CM30-16BNP-KC1	6021460	D-204
CM30-16BNP-KW1	6021459	D-204
CM30-16BPP-KC1	6020475	D-204
CM30-16BPP-KW1	6020473	D-204
CM30-25NAP-KW1	6028413	D-204
CM30-25NNP-KC1	6021462	D-204

Model name	Part no.	Page
CM30-25NNP-KW1	6021461	D-204
CM30-25NPP-KC1	6020477	D-204
CM30-25NPP-KW1	6020476	D-204
CQ28-10NNP-KW1	6030133	D-216
CQ28-10NPP-KW1	6030132	D-216
CQ35-25NNP-KC1	6021464	D-216
CQ35-25NNP-KW1	6021463	D-216
CQ35-25NPP-KC1	6020479	D-216
CQ35-25NPP-KW1	6020478	D-216
DOL-0803-G02M	6010785	G-267
DOL-0803-G02MC	6025888	G-267
DOL-0803-G02MN	6033664	G-274
DOL-0803-G05M	6022009	G-267
DOL-0803-G05MC	6025889	G-267
DOL-0803-G05MN	6033665	G-274
DOL-0803-G10M	6022011	G-267
DOL-0803-G10MC	6025890	G-267
DOL-0803-G10MN	6033666	G-274
DOL-0803-G15M	6036472	G-267
DOL-0803-W02M	6008489	G-267
DOL-0803-W02MC	6025891	G-267
DOL-0803-W02MN	6033667	G-274
DOL-0803-W05M	6022010	G-267
DOL-0803-W05MC	6025892	G-267
DOL-0803-W05MN	6033668	G-274
DOL-0803-W10M	6022012	G-267
DOL-0803-W10MC	6025893	G-267
DOL-0803-W10MN	6033669	G-274
DOL-0803-W15M	6036473	G-267
DOL-0804-G02M	6009870	G-267
DOL-0804-G02MC	6025894	G-267
DOL-0804-G02MN	6033670	G-274
DOL-0804-G05M	6009872	G-267
DOL-0804-G05MC	6025895	G-267
DOL-0804-G05MN	6033671	G-274
DOL-0804-G10M	6010754	G-267
DOL-0804-G10MC	6025896	G-267
DOL-0804-G10MN	6033672	G-274
DOL-0804-W02M	6009871	G-267
DOL-0804-W02MC	6025897	G-267
DOL-0804-W02MN	6033673	G-274
DOL-0804-W05M	6009873	G-267
DOL-0804-W05MC	6025898	G-267
DOL-0804-W05MN	6033674	G-274
DOL-0804-W10M	6010755	G-267
DOL-0804-W10MC	6025899	G-267
DOL-0804-W10MN	6033675	G-274
DOL-1204-G02M	6009382	G-267
DOL-1204-G02MC	6025900	G-267
DOL-1204-G02MN	6028128	G-274
DOL-1204-G05M	6009866	G-267
DOL-1204-G05MC	6025901	G-267
DOL-1204-G05MN	6028130	G-274
DOL-1204-G10M	6010543	G-267
DOL-1204-G10MC	6025902	G-267
DOL-1204-G10MN	6028132	G-274
DOL-1204-G25MN	6028134	G-274
DOL-1204-L02M	6027945	G-268

Model name	Part no.	Page	Model name	Part no.	Page
DOL-1204-L02MN	6028136	G-274	DSL-1204-G0M6N	6028194	G-271
DOL-1204-L05M	6027944	G-268	DSL-1204-G10M	6034406	G-275
DOL-1204-L05MN	6028137	G-274	DSL-1204-G10MC	6033698	G-271
DOL-1204-L10M	6027946	G-268	DSL-1204-G1M5	6034822	G-271
DOL-1204-L10MN	6028138	G-274	DSL-1205-G01MC	6029280	G-271
DOL-1204-L25MN	6028139	G-274	DSL-1205-G02MC	6025931	G-271
DOL-1204-W02M	6009383	G-267	DSL-1205-G05MC	6029282	G-271
DOL-1204-W02MC	6025903	G-267	DSL-1205-G10MC	6038954	G-271
DOL-1204-W02MN	6028129	G-274	DSL-1205-G15MC	6038956	G-271
DOL-1204-W05M	6009867	G-267	DSL-1205-G1M5C	6029281	G-271
DOL-1204-W05MC	6025904	G-267	DSL-1205-G20MC	6038957	G-271
DOL-1204-W05MN	6028131	G-274	DSL-8203-B02MC	6025917	G-270
DOL-1204-W10M	6010541	G-267	DSL-8203-B05MC	6039185	G-270
DOL-1204-W10MC	6025905	G-267	DSL-8203-B0M6C	6025916	G-270
DOL-1204-W10MN	6028133	G-274	DSL-8203-G02M	6022572	G-270
DOL-1204-W25MN	6028135	G-274	DSL-8203-G02MC	6025915	G-270
DOL-1205-G02M	6008899	G-268	DSL-8203-G05MC	6030608	G-270
DOL-1205-G02MC	6025906	G-268	DSL-8203-G0M6	6022570	G-270
DOL-1205-G02MN	6028140	G-274	DSL-8203-G0M6C	6025914	G-270
DOL-1205-G05M	6009868	G-268	DSL-8204-B02MC	6025921	G-271
DOL-1205-G05MAC	6036384	G-268	DSL-8204-B05MC	6039182	G-271
DOL-1205-G05MC	6025907	G-268	DSL-8204-B0M6C	6025920	G-271
DOL-1205-G05MN	6028141	G-274	DSL-8204-G02M	6022573	G-271
DOL-1205-G10M	6010544	G-268	DSL-8204-G02MC	6025919	G-271
DOL-1205-G10MAC	6036385	G-268	DSL-8204-G05M	6034403	G-271
DOL-1205-G10MC	6025908	G-268	DSL-8204-G05MC	6039181	G-271
DOL-1205-G10MN	6028142	G-274	DSL-8204-G0M6	6022571	G-271
DOL-1205-W05MAC	6041751	G-268	DSL-8204-G0M6C	6025918	G-271
DOL-1205-W10MAC	6041752	G-268	DSL-8204-G10M	6034404	G-271
DOS-0803-G	7902077	G-277	EN2-2EX-1	6041096	G-280
DOS-0803-W	7902078	G-277	EN2-2EX-3	6041095	G-280
DOS-0804-G	6009974	G-277	IH03-0B6NS-VU1	6020142	C-144
DOS-0804-W	6009975	G-277	IH03-0B6PO-VU1	6020143	C-144
DOS-1204-G	6007302	G-277	IH03-0B6PS-VR1	6038602	C-144
DOS-1204-GN	6028357	G-277	IH03-0B6PS-VU1	6020141	C-144
DOS-1204-W	6007303	G-277	IH04-0B8NS-VT1	6020152	C-144
DOS-1205-G	6009719	G-277	IH04-0B8NS-VW1	6020149	C-144
DOS-1205-W	6009720	G-277	IH04-0B8PS-VR1	6045178	C-144
DOS1204-WN	6028358	G-277	IH04-0B8PS-VT1	6020114	C-144
DSL-0804-G02M	6034665	G-271	IH04-0B8PS-VW1	6020113	C-144
DSL-0804-G02MC	6036335	G-271	IH06-02BNS-VT1	7900180	C-150
DSL-0804-G05MC	6039090	G-271	IH06-02BNS-VTK	6025878	C-150
DSL-0804-G0M6	6034664	G-271	IH06-02BNS-VW1	7900178	C-150
DSL-0804-G0M6C	6039089	G-271	IH06-02BNS-VWK	6025875	C-150
DSL-0804-G1M5	6042050	G-271	IH06-02BPO-VT1	1016857	C-150
DSL-0804-G20M	6039087	G-271	IH06-02BPO-VTK	6025879	C-150
DSL-1204-B02MN	6028198	G-275	IH06-02BPS-VT1	7900179	C-151
DSL-1204-B05MN	6028199	G-275	IH06-02BPS-VTK	6025877	C-151
DSL-1204-B0M6N	6028197	G-275	IH06-02BPS-VW1	7900177	C-151
DSL-1204-G01MC	6033244	G-271	IH06-02BPS-VWK	6025874	C-151
DSL-1204-G02M	6022567	G-271	IH06-04NNS-VTK	6025883	C-151
DSL-1204-G02MC	6025927	G-275	IH06-04NNS-VW1	7900182	C-151
DSL-1204-G02MN	6028195	G-271	IH06-04NNS-VWK	6025881	C-151
DSL-1204-G05M	6022569	G-271	IH06-04NPO-VTK	6025884	C-151
DSL-1204-G05MC	6033245	G-271	IH06-04NPS-VT1	7900183	C-151
DSL-1204-G05MN	6028196	G-271	IH06-04NPS-VTK	6025882	C-151
DSL-1204-G0M6	6022565	G-275	IH06-04NPS-VW1	7900181	C-151
DSL-1204-G0M6C	6025926	G-271	IH06-04NPS-VWK	6025880	C-151

Model name	Part no.	Page
IH06-1B5NS-VTK	6020170	C-151
IH06-1B5NS-VWK	6020166	C-151
IH06-1B5PO-VTK	6020171	C-151
IH06-1B5PO-VWK	6020167	C-151
IH06-1B5PS-VTK	6020169	C-151
IH06-1B5PS-VWK	6020165	C-151
IH20-10NUO-KU0	7902131	C-151
IH20-10NUS-KU0	7902130	C-151
IH34-30NUO-KU0	7902135	C-152
IH34-30NUS-KU0	7902134	C-152
IM04-0B6NS-ZU1	6020146	C-34
IM04-0B6PO-ZU1	6020147	C-34
IM04-0B6PS-ZR1	6042085	C-34
IM04-0B6PS-ZU1	6020145	C-34
IM05-0B8NO-ZW1	6020157	C-34
IM05-0B8NS-ZT1	6020158	C-34
IM05-0B8NS-ZW1	6020155	C-34
IM05-0B8PO-ZT1	6020159	C-34
IM05-0B8PS-ZT1	6020110	C-34
IM05-0B8PS-ZW1	6011591	C-34
IM05-1B5NOVT0S	6049738	C-34
IM05-1B5NOVU2S	6049734	C-34
IM05-1B5NSVT0S	6049737	C-34
IM05-1B5NSVU2S	6049733	C-34
IM05-1B5POVT0S	6049740	C-34
IM05-1B5POVU2S	6049736	C-34
IM05-1B5PSVT0S	6049739	C-34
IM05-1B5PSVU2S	6049735	C-34
IM08-01B-N-ZW0	6021123	C-48
IM08-03BNS-ZW1	6028074	C-48
IM08-03BPS-ZT1	6025574	C-48
IM08-03BPS-ZW1	6027505	C-48
IM08-06NNS-ZW1	6027507	C-48
IM08-06NPS-ZT1	6027508	C-48
IM08-06NPS-ZW1	6027506	C-126
IM08-1B5NS-ZTK	6020176	C-100
IM08-1B5NS-ZWK	6020173	C-100
IM08-1B5PO-ZTK	6020177	C-100
IM08-1B5PO-ZWK	6020174	C-100
IM08-1B5PS-ZTK	6020112	C-100
IM08-1B5PS-ZWK	6020111	C-100
IM12-02B-N-ZW0	6021124	C-52
IM12-02BAO-ZU0	7902119	C-52
IM12-02BAS-ZU0	7902118	C-66
IM12-02BCP-ZC1	7902928	C-66
IM12-02BCP-ZW1	7902927	C-52
IM12-02BDO-ZW1	6020311	C-52
IM12-02BDS-ZC1	6020312	C-52
IM12-02BDS-ZW1	6020310	C-126
IM12-04N-N-ZW0	6021125	C-52
IM12-04NAO-ZU0	7902121	C-52
IM12-04NAS-ZU0	7902120	C-66
IM12-04NCP-ZC1	7902930	C-66
IM12-04NCP-ZW1	7902929	C-52
IM12-04NDO-ZC1	6020317	C-52
IM12-04NDO-ZW1	6020315	C-52
IM12-04NDS-ZC1	6020316	C-52
IM12-04NDS-ZW1	6020314	C-126

Model name	Part no.	Page
IM12-06BNS-NC1	6027573	C-120
IM12-06BNS-ZC1	6030524	C-100
IM12-06BPO-NC1	6027574	C-120
IM12-06BPO-ZW1	6027510	C-100
IM12-06BPS-NC1	6027572	C-120
IM12-06BPS-ZC1	6027511	C-100
IM12-06BPS-ZW1	6027509	C-100
IM12-10NNS-NC1	6027576	C-120
IM12-10NNS-ZW1	6027513	C-100
IM12-10NPS-NC1	6027575	C-120
IM12-10NPS-ZC1	6027514	C-100
IM12-10NPS-ZW1	6027512	C-100
IM18-05B-N-ZW0	6021126	C-72
IM18-05BDO-ZC1	6020321	C-72
IM18-05BDS-ZC1	6020320	C-72
IM18-05BDS-ZW1	6020318	C-126
IM18-05BUO-ZU0	7902123	C-72
IM18-05BUS-ZU0	7902122	C-72
IM18-08N-N-ZW0	6021127	C-72
IM18-08NDS-ZC1	6020324	C-72
IM18-08NDS-ZW1	6020322	C-126
IM18-08NUO-ZU0	7902125	C-72
IM18-08NUS-ZU0	7902124	C-72
IM18-10BNS-NC1	6027578	C-120
IM18-10BPO-NC1	6027579	C-120
IM18-10BPS-NC1	6027577	C-120
IM18-12BNS-ZW1	6027516	C-101
IM18-12BPS-ZC1	6027517	C-101
IM18-12BPS-ZCK	6025569	C-101
IM18-12BPS-ZW1	6027515	C-101
IM18-20NNS-NC1	6027581	C-120
IM18-20NNS-ZC1	6041997	C-101
IM18-20NNS-ZW1	6028093	C-101
IM18-20NPS-NC1	6027580	C-120
IM18-20NPS-ZC1	6027519	C-101
IM18-20NPS-ZW1	6027518	C-101
IM30-10B-N-ZW0	6021128	C-86
IM30-10BDS-ZC1	6020328	C-86
IM30-10BDS-ZW1	6020326	C-126
IM30-10BUO-ZU0	7902127	C-86
IM30-10BUS-ZU0	7902126	C-86
IM30-15N-N-ZW0	6021129	C-86
IM30-15NDS-ZC1	6020332	C-86
IM30-15NDS-ZW1	6020330	C-126
IM30-15NUO-ZU0	7902129	C-86
IM30-15NUS-ZU0	7902128	C-86
IM30-20BNS-NC1	6027583	C-120
IM30-20BPS-NC1	6027582	C-120
IM30-22BNS-ZC1	6033033	C-101
IM30-22BNS-ZW1	6027520	C-101
IM30-22BPO-ZCK	6025568	C-101
IM30-22BPS-ZC1	6027521	C-101
IM30-22BPS-ZCK	6025566	C-101
IM30-40NNS-NC1	6027585	C-120
IM30-40NNS-ZC1	6033087	C-101
IM30-40NPS-NC1	6027584	C-120
IM30-40NPS-ZC1	6027522	C-101
IMA08-04BE3ZCOK	6041782	C-134

Model name	Part no.	Page
IMA12-06BE3ZCOK	6041792	C-134
IMA18-10BE1ZCOK	6041793	C-134
IMA18-20NE1ZCOK	6041794	C-134
IMA30-20BE1ZCOK	6041795	C-135
IMA30-40NE1ZCOK	6041796	C-135
IME08-02BNOZTOK	1040881	C-40
IME08-02BNOZTOS	1040882	C-40
IME08-02BNOZW2K	1040883	C-40
IME08-02BNOZW2S	1040884	C-40
IME08-02BNSZCOS	1051127	C-40
IME08-02BNSZTOK	1040877	C-40
IME08-02BNSZTOS	1040878	C-40
IME08-02BNSZW2K	1040879	C-40
IME08-02BNSZW2S	1040880	C-40
IME08-02BPOZCOS	1051207	C-40
IME08-02BPOZTOK	1040873	C-40
IME08-02BPOZTOS	1040874	C-40
IME08-02BPOZW2K	1040875	C-40
IME08-02BPOZW2S	1040876	C-40
IME08-02BPSZCOS	1051205	C-40
IME08-02BPSZTOK	1040869	C-40
IME08-02BPSZTOS	1040870	C-40
IME08-02BPSZW2K	1040871	C-40
IME08-02BPSZW2S	1040872	C-40
IME08-04NNOZTOK	1040897	C-40
IME08-04NNOZTOS	1040898	C-40
IME08-04NNOZW2K	1040899	C-40
IME08-04NNOZW2S	1040900	C-40
IME08-04NNSZTOK	1040893	C-40
IME08-04NNSZTOS	1040894	C-40
IME08-04NNSZW2K	1040895	C-40
IME08-04NNSZW2S	1040896	C-40
IME08-04NPOZCOS	1051208	C-40
IME08-04NPOZTOK	1040889	C-40
IME08-04NPOZTOS	1040890	C-40
IME08-04NPOZW2K	1040891	C-40
IME08-04NPOZW2S	1040892	C-40
IME08-04NPSZCOS	1051209	C-40
IME08-04NPSZTOK	1040885	C-40
IME08-04NPSZTOS	1040886	C-40
IME08-04NPSZW2K	1040887	C-41
IME08-04NPSZW2S	1040888	C-41
IME08-1B5NOZTOK	1040849	C-41
IME08-1B5NOZTOS	1040850	C-41
IME08-1B5NOZW2K	1040851	C-41
IME08-1B5NOZW2S	1040852	C-41
IME08-1B5NSZTOK	1040845	C-41
IME08-1B5NSZTOS	1040846	C-41
IME08-1B5NSZW2K	1040847	C-41
IME08-1B5NSZW2S	1040848	C-41
IME08-1B5POZTOK	1040841	C-41
IME08-1B5POZTOS	1040842	C-41
IME08-1B5POZW2K	1040843	C-41
IME08-1B5POZW2S	1040844	C-41
IME08-1B5PSZTOK	1040837	C-41
IME08-1B5PSZTOS	1040838	C-41
IME08-1B5PSZW2K	1040839	C-41
IME08-1B5PSZW2S	1040840	C-41

Model name	Part no.	Page
IME08-2N5NOZTOK	1040865	C-41
IME08-2N5NOZTOS	1040866	C-41
IME08-2N5NOZW2K	1040867	C-41
IME08-2N5NOZW2S	1040868	C-41
IME08-2N5NSZTOK	1040861	C-41
IME08-2N5NSZTOS	1040862	C-41
IME08-2N5NSZW2K	1040863	C-41
IME08-2N5NSZW2S	1040864	C-41
IME08-2N5POZTOK	1040857	C-41
IME08-2N5POZTOS	1040858	C-41
IME08-2N5POZW2K	1040859	C-41
IME08-2N5POZW2S	1040860	C-41
IME08-2N5PSZTOK	1040853	C-41
IME08-2N5PSZTOS	1040854	C-41
IME08-2N5PSZW2K	1040855	C-41
IME08-2N5PSZW2S	1040856	C-41
IME12-02BNOZCOK	1040744	C-58
IME12-02BNOZCOS	1040743	C-58
IME12-02BNOZW2K	1040745	C-58
IME12-02BNOZW2S	1040746	C-58
IME12-02BNSZCOK	1040739	C-58
IME12-02BNSZCOS	1040740	C-58
IME12-02BNSZW2K	1040741	C-58
IME12-02BNSZW2S	1040742	C-58
IME12-02BPOZCOK	1040735	C-58
IME12-02BPOZCOS	1040736	C-58
IME12-02BPOZW2K	1040737	C-58
IME12-02BPOZW2S	1040738	C-58
IME12-02BPSZCOK	1040731	C-58
IME12-02BPSZCOS	1040732	C-58
IME12-02BPSZW2K	1040733	C-58
IME12-02BPSZW2S	1040734	C-58
IME12-04BNOZCOK	1040775	C-58
IME12-04BNOZCOS	1040776	C-58
IME12-04BNOZW2K	1040777	C-58
IME12-04BNOZW2S	1040778	C-58
IME12-04BNSZCOK	1040771	C-58
IME12-04BNSZCOS	1040772	C-58
IME12-04BNSZW2K	1040773	C-58
IME12-04BNSZW2S	1040774	C-58
IME12-04BPOZCOK	1040767	C-58
IME12-04BPOZCOS	1040768	C-58
IME12-04BPOZW2K	1040769	C-58
IME12-04BPOZW2S	1040770	C-58
IME12-04BPPZW2K	1056423	C-58
IME12-04BPSZCOK	1040763	C-58
IME12-04BPSZCOS	1040764	C-58
IME12-04BPSZTOK	1042973	C-58
IME12-04BPSZW2K	1040765	C-58
IME12-04BPSZW2S	1040766	C-58
IME12-04NNOZCOK	1040759	C-59
IME12-04NNOZCOS	1040760	C-59
IME12-04NNOZW2K	1040761	C-59
IME12-04NNOZW2S	1040762	C-59
IME12-04NNSZCOK	1040755	C-59
IME12-04NNSZCOS	1040756	C-59
IME12-04NNSZW2K	1040758	C-59
IME12-04NNSZW2S	1040757	C-59

Model name	Part no.	Page
IME12-04NPOZC0K	1040751	C-59
IME12-04NPOZC0S	1040752	C-59
IME12-04NPOZW2K	1040753	C-59
IME12-04NPOZW2S	1040754	C-59
IME12-04NPPZC0K	1043660	C-59
IME12-04NPSZC0K	1040747	C-59
IME12-04NPSZC0S	1040748	C-59
IME12-04NPSZW2K	1040749	C-59
IME12-04NPSZW2S	1040750	C-59
IME12-08NNOZC0K	1040791	C-59
IME12-08NNOZC0S	1040826	C-59
IME12-08NNOZW2K	1040792	C-59
IME12-08NNOZW2S	1040793	C-59
IME12-08NNSZC0K	1040787	C-59
IME12-08NNSZC0S	1040788	C-59
IME12-08NNSZW2K	1040789	C-59
IME12-08NNSZW2S	1040790	C-59
IME12-08NPOZC0K	1040783	C-59
IME12-08NPOZC0S	1040784	C-59
IME12-08NPOZW2K	1040785	C-59
IME12-08NPOZW2S	1040786	C-59
IME12-08NPSZC0K	1040779	C-59
IME12-08NPSZC0S	1040780	C-59
IME12-08NPSZW2K	1040781	C-59
IME12-08NPSZW2S	1040782	C-59
IME18-05BNOZC0K	1040945	C-78
IME18-05BNOZC0S	1040946	C-78
IME18-05BNOZW2K	1040947	C-78
IME18-05BNOZW2S	1040948	C-78
IME18-05BNSZC0K	1040941	C-78
IME18-05BNSZC0S	1040942	C-78
IME18-05BNSZW2K	1040943	C-78
IME18-05BNSZW2S	1040944	C-78
IME18-05BPOZC0K	1040937	C-78
IME18-05BPOZC0S	1040938	C-78
IME18-05BPOZW2K	1040939	C-78
IME18-05BPOZW2S	1040940	C-78
IME18-05BPPZC0S	1046743	C-78
IME18-05BPSZC0K	1040933	C-78
IME18-05BPSZC0S	1040934	C-78
IME18-05BPSZW2K	1040935	C-78
IME18-05BPSZW2S	1040936	C-78
IME18-08BNOZC0K	1040977	C-78
IME18-08BNOZC0S	1040978	C-78
IME18-08BNOZW2K	1040979	C-78
IME18-08BNOZW2S	1040980	C-78
IME18-08BNSZC0K	1040973	C-78
IME18-08BNSZC0S	1040974	C-78
IME18-08BNSZW2K	1040975	C-78
IME18-08BNSZW2S	1040976	C-78
IME18-08BPOZC0K	1040969	C-78
IME18-08BPOZC0S	1040970	C-78
IME18-08BPOZW2K	1040971	C-78
IME18-08BPOZW2S	1040972	C-78
IME18-08BPPZC0S	1056708	C-78
IME18-08BPSZC0K	1040965	C-78
IME18-08BPSZC0S	1040966	C-78
IME18-08BPSZW2K	1040967	C-78

Model name	Part no.	Page
IME18-08BPSZW2S	1040968	C-78
IME18-08NNOZC0K	1040961	C-79
IME18-08NNOZC0S	1040962	C-79
IME18-08NNOZW2S	1040964	C-79
IME18-08NNSZC0K	1040957	C-79
IME18-08NNSZC0S	1040958	C-79
IME18-08NNSZW2K	1040959	C-79
IME18-08NNSZW2S	1040960	C-79
IME18-08NPOZC0K	1040953	C-79
IME18-08NPOZC0S	1040954	C-79
IME18-08NPOZW2K	1040955	C-79
IME18-08NPOZW2S	1040956	C-79
IME18-08NPPZC0S	1046894	C-79
IME18-08NPSZC0K	1040949	C-79
IME18-08NPSZC0S	1040950	C-79
IME18-08NPSZW2K	1040951	C-79
IME18-08NPSZW2S	1040952	C-79
IME18-12NNOZC0K	1040993	C-79
IME18-12NNOZC0S	1040994	C-79
IME18-12NNOZW2K	1040995	C-79
IME18-12NNOZW2S	1040996	C-79
IME18-12NNSZC0K	1040989	C-79
IME18-12NNSZC0S	1040990	C-79
IME18-12NNSZW2K	1040991	C-79
IME18-12NNSZW2S	1040992	C-79
IME18-12NPOZC0K	1040985	C-79
IME18-12NPOZC0S	1040986	C-79
IME18-12NPOZW2K	1040987	C-79
IME18-12NPOZW2S	1040988	C-79
IME18-12NPPZC0S	1044127	C-79
IME18-12NPSZC0K	1040981	C-79
IME18-12NPSZC0S	1040982	C-79
IME18-12NPSZW2K	1040983	C-79
IME18-12NPSZW2S	1040984	C-79
IME30-10BNOZC0K	1041010	C-92
IME30-10BNOZC0S	1041009	C-92
IME30-10BNOZW2K	1041011	C-92
IME30-10BNOZW2S	1041012	C-92
IME30-10BNSZC0K	1041005	C-92
IME30-10BNSZC0S	1041006	C-92
IME30-10BNSZW2K	1041007	C-92
IME30-10BNSZW2S	1041008	C-92
IME30-10BPOZC0K	1041001	C-92
IME30-10BPOZC0S	1041002	C-92
IME30-10BPOZW2K	1041003	C-92
IME30-10BPOZW2S	1041004	C-92
IME30-10BPSZC0K	1040997	C-92
IME30-10BPSZC0S	1040998	C-92
IME30-10BPSZW2K	1040999	C-92
IME30-10BPSZW2S	1041000	C-92
IME30-15BNOZC0K	1041041	C-92
IME30-15BNOZC0S	1041042	C-92
IME30-15BNOZW2K	1041043	C-92
IME30-15BNOZW2S	1041044	C-92
IME30-15BNSZC0K	1041037	C-92
IME30-15BNSZC0S	1041038	C-92
IME30-15BNSZW2K	1041039	C-92
IME30-15BNSZW2S	1041040	C-92

Model name	Part no.	Page
IME30-15BPOZCOK	1041033	C-92
IME30-15BPOZCOS	1041034	C-92
IME30-15BPOZW2K	1041035	C-92
IME30-15BPOZW2S	1041036	C-92
IME30-15BPPZW2K	1057551	C-92
IME30-15BPSZCOK	1041029	C-92
IME30-15BPSZCOS	1041030	C-92
IME30-15BPSZW2K	1041031	C-92
IME30-15BPSZW2S	1041032	C-92
IME30-15NNOZCOK	1041025	C-93
IME30-15NNOZCOS	1041026	C-93
IME30-15NNOZW2K	1041027	C-93
IME30-15NNOZW2S	1041028	C-93
IME30-15NNSZCOK	1041021	C-93
IME30-15NNSZCOS	1041022	C-93
IME30-15NNSZW2K	1041023	C-93
IME30-15NNSZW2S	1041024	C-93
IME30-15NPOZCOK	1041017	C-93
IME30-15NPOZCOS	1041018	C-93
IME30-15NPOZW2K	1041019	C-93
IME30-15NPOZW2S	1041020	C-93
IME30-15NPSZCOK	1041013	C-93
IME30-15NPSZCOS	1041014	C-93
IME30-15NPSZW2K	1041015	C-93
IME30-15NPSZW2S	1041016	C-93
IME30-20NNOZCOK	1041057	C-93
IME30-20NNOZCOS	1041058	C-93
IME30-20NNOZW2K	1041059	C-93
IME30-20NNOZW2S	1041060	C-93
IME30-20NNSZCOK	1041053	C-93
IME30-20NNSZCOS	1041054	C-93
IME30-20NNSZW2K	1041055	C-93
IME30-20NNSZW2S	1041056	C-93
IME30-20NPOZCOK	1041049	C-93
IME30-20NPOZCOS	1041050	C-93
IME30-20NPOZW2K	1041051	C-93
IME30-20NPOZW2S	1041052	C-93
IME30-20NPSZCOK	1041045	C-93
IME30-20NPSZCOS	1041046	C-93
IME30-20NPSZW2K	1041047	C-93
IME30-20NPSZW2S	1041048	C-93
IMF12-02BNOVCOS	6035455	C-112
IMF12-02BNPVCOS	6035216	C-112
IMF12-02BNSVCOS	6035453	C-112
IMF12-02BPOVCOS	6035454	C-112
IMF12-02BPPVCOS	6035215	C-112
IMF12-02BPSVCOS	6035452	C-112
IMF12-04BNOVCOS	6035463	C-112
IMF12-04BNPVCOS	6035220	C-112
IMF12-04BNSVCOS	6035461	C-112
IMF12-04BPOVCOS	6035462	C-112
IMF12-04BPPVCOS	6035219	C-112
IMF12-04BPSVCOS	6035460	C-112
IMF12-04NNOVCOS	6035459	C-112
IMF12-04NPPVCOS	6035218	C-112
IMF12-04NNSVCOS	6035457	C-112
IMF12-04NPOVCOS	6035458	C-112
IMF12-04NPPVCOS	6035217	C-112

Model name	Part no.	Page
IMF12-04NPSVCOS	6035456	C-112
IMF12-08NNOVCOS	6035467	C-113
IMF12-08NNPVCOS	6035222	C-113
IMF12-08NNSVCOS	6035465	C-113
IMF12-08NPOVCOS	6035466	C-113
IMF12-08NPPVCOS	6035221	C-113
IMF12-08NPSVCOS	6035464	C-113
IMF18-05BNOVCOS	6035471	C-113
IMF18-05BNPVCOS	6035224	C-113
IMF18-05BNSVCOS	6035469	C-113
IMF18-05BPOVCOS	6035470	C-113
IMF18-05BPPVCOS	6035223	C-113
IMF18-05BPSVCOS	6035468	C-113
IMF18-08BNOVCOS	6035479	C-113
IMF18-08BNPVCOS	6035228	C-113
IMF18-08BNSVCOS	6035477	C-113
IMF18-08BPOVCOS	6035478	C-113
IMF18-08BPPVCOS	6035227	C-113
IMF18-08BPSVCOS	6035476	C-113
IMF18-08NNOVCOS	6035475	C-113
IMF18-08NNPVCOS	6035226	C-113
IMF18-08NNSVCOS	6035473	C-113
IMF18-08NPOVCOS	6035474	C-113
IMF18-08NPPVCOS	6035225	C-113
IMF18-08NPSVCOS	6035472	C-113
IMF18-12NNOVCOS	6035483	C-113
IMF18-12NNPVCOS	6035230	C-113
IMF18-12NNSVCOS	6035481	C-113
IMF18-12NPOVCOS	6035482	C-113
IMF18-12NPPVCOS	6035229	C-113
IMF18-12NPSVCOS	6035480	C-113
IQ04-1B5NOKW2S	6042020	C-164
IQ04-1B5NSKW2S	6042019	C-164
IQ04-1B5POKW2S	6042018	C-164
IQ04-1B5PSKW2S	6042017	C-164
IQ05-0B8NS-ZU1	6020162	C-158
IQ05-0B8PO-ZU1	6020163	C-158
IQ05-0B8PS-ZU1	6020161	C-158
IQ06-03BNOKU2S	6042025	C-164
IQ06-03BNSKU2S	6042024	C-164
IQ06-03BPOKU2S	6042023	C-164
IQ06-03BPSKU2S	6042022	C-164
IQ08-02BNOKTOS	1055497	C-158
IQ08-02BNOKW2S	1055493	C-158
IQ08-02BNSKTOS	1055496	C-158
IQ08-02BNSKW2S	1055492	C-158
IQ08-02BPOKTOS	1055495	C-158
IQ08-02BPOKW2S	1055491	C-158
IQ08-02BPSKTOS	1055494	C-158
IQ08-02BPSKW2S	1055490	C-158
IQ08-04NNOKTOS	1055505	C-159
IQ08-04NNOKW2S	1055501	C-159
IQ08-04NNSKTOS	1055504	C-159
IQ08-04NNSKW2S	1055500	C-159
IQ08-04NPOKTOS	1055503	C-159
IQ08-04NPOKW2S	1055499	C-159
IQ08-04NPSKTOS	1055502	C-159
IQ08-04NPSKW2S	1055498	C-159

Model name	Part no.	Page
IQ10-03BNOKT0S	1055456	C-170
IQ10-03BNOKW2S	1055452	C-170
IQ10-03BNPKW2S	1055466	C-170
IQ10-03BNSKT0S	1055455	C-170
IQ10-03BNSKW2S	1055450	C-170
IQ10-03BPOKT0S	1055454	C-170
IQ10-03BPOKW2S	1055449	C-170
IQ10-03BPPKW2S	1055465	C-170
IQ10-03BPSKT0S	1055453	C-170
IQ10-03BPSKW2S	1055447	C-170
IQ10-06NNOKT0S	1055464	C-170
IQ10-06NNOKW2S	1055460	C-170
IQ10-06NNSKT0S	1055463	C-170
IQ10-06NNSKW2S	1055459	C-170
IQ10-06NPOKT0S	1055462	C-170
IQ10-06NPOKW2S	1055458	C-170
IQ10-06NPSKT0S	1055461	C-170
IQ10-06NPSKW2S	1055457	C-170
IQ12-04BNOKT0S	1055435	C-176
IQ12-04BNOKW2S	1055431	C-176
IQ12-04BNPKW2S	1055445	C-176
IQ12-04BNSKT0S	1055434	C-176
IQ12-04BNSKW2S	1055430	C-176
IQ12-04BPOKT0S	1055433	C-176
IQ12-04BPOKW2S	1055429	C-176
IQ12-04BPPKW2S	1055444	C-176
IQ12-04BPSKT0S	1055432	C-176
IQ12-04BPSKW2S	1055428	C-176
IQ12-08NNOKT0S	1055443	C-176
IQ12-08NNOKW2S	1055439	C-176
IQ12-08NNSKT0S	1055442	C-176
IQ12-08NNSKW2S	1055438	C-176
IQ12-08NPOKT0S	1055441	C-176
IQ12-08NPOKW2S	1055437	C-176
IQ12-08NPSKT0S	1055440	C-176
IQ12-08NPSKW2S	1055436	C-176
IQ20-07BNSDPOS	6042044	C-164
IQ20-07BPPDQ0S	6042045	C-164
IQ20-07BPSDPOS	6042043	C-164
IQ25-05BPPDU2S	6042047	C-164
IQ25-05BPSDU2S	6042046	C-164
IQ40-15BAP-KK1	6025816	C-187
IQ40-15BDP-KK1	6025817	C-186
IQ40-15BPP-KK0	7900219	C-186
IQ40-15BPP-KK1	6025814	C-186
IQ40-15BUP-KK0	7902136	C-186
IQ40-20BPPK0K	6037072	C-182
IQ40-20BPSK0K	6037070	C-182
IQ40-20NPP-KK0	7900221	C-186
IQ40-20NPP-KK1	6025815	C-186
IQ40-20NUP-KK0	7902137	C-186
IQ40-40NPPK0K	6037073	C-182
IQ40-40NPSK0K	6037071	C-182
IQ80-50BPP-KC0	6026473	C-192
IQ80-60NPP-KK0	7900227	C-192
IQ80-60NUP-KK0	7902138	C-192
MAG-0625-A (M 5.0)	7901783	G-266
MAG-1003-S (M 5.0)	7901782	G-266

Model name	Part no.	Page
MAG-2006-B (M 4.0)	7901784	G-266
MAG-3010-B (M 3.0)	7901785	G-266
MAG-3015-B (M 1.0)	7901786	G-266
MAG-3515-B (M 2.0)	7902086	G-266
MM08-60ANS-ZTK	1040068	E-228
MM08-60ANS-ZUK	1040066	E-228
MM08-60APS-ZTK	1040067	E-228
MM08-60APS-ZUK	1040027	E-228
MM12-60A-N-ZC0	7900287	E-228
MM12-60A-N-ZW0	7900286	E-228
MM12-60ANS-ZCK	1040071	E-238
MM12-60ANS-ZUK	1040026	E-238
MM12-60APO-ZUK	1040065	E-228
MM12-60APS-ZCK	1040070	E-228
MM12-60APS-ZUK	1040069	E-228
MM12-90A-N-ZUD	1046761	E-228
MM12-90ANS-ZU0	1051013	E-238
MM12-90APS-ZC0	1029950	E-228
MM12-90APS-ZU0	1029951	E-228
MM18-00A-N-ZC0	1026614	E-238
MM18-00APS-ZC0	1029861	E-229
MM18-00APS-ZU0	1029952	E-229
MM18-70A-N-ZC0	7900289	E-229
MM18-70A-N-ZW0	7900288	E-229
MM18-70ANS-ZCK	1040073	E-238
MM18-70ANS-ZUK	1040085	E-238
MM18-70APO-ZCK	1047255	E-229
MM18-70APS-VCK	1050765	E-229
MM18-70APS-ZCK	1040072	E-229
MM18-70APS-ZUK	1040029	E-229
MQ10-60ANS-KT0	7900281	E-246
MQ10-60ANS-KU0	7900279	E-246
MQ10-60APS-KP0	1017405	E-246
MQ10-60APS-KT0	7900280	E-246
MQ10-60APS-KU0	7900278	E-246
STE-0803-G	6037322	G-277
STE-0804-G	6037323	G-277
STE-1204-G	6009932	G-277
STE-1204-GN	6028359	G-277
STE-1204-TN	6028360	G-277
STE-1204-W	6022084	G-277
STE-1205-G	6022083	G-277
STE-1205-W	6022082	G-277

SICK at a glance

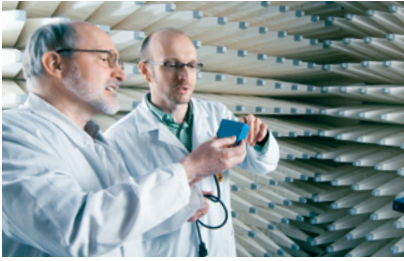

Leading technologies

With a staff of more than 5,800 and nearly 50 subsidiaries and representations worldwide, SICK is one of the leading and most successful manufacturers of sensor technology. The power of innovation and solution competency have made SICK the global market leader. No matter what the project and industry may be, talking with an expert from SICK will provide you with an ideal basis for your plans – there is no need to settle for anything less than the best.



Unique product range

- Non-contact detecting, counting, classifying, positioning and measuring of any type of object or media
- Accident and operator protection with sensors, safety software and services
- Automatic identification with bar code and RFID readers
- Laser measurement technology for detecting the volume, position and contour of people and objects
- Complete system solutions for analysis and flow measurement of gases and liquids



Comprehensive services

- SICK LifeTime Services – for safety and productivity
- Application centers in Europe, Asia and North America for the development of system solutions under real-world conditions
- E-Business Partner Portal www.mysick.com – price and availability of products, requests for quotation and online orders

Worldwide presence with subsidiaries in the following countries:

Australia
Belgium/Luxembourg
Brasil
Česká Republika
Canada
China
Danmark
Deutschland
España
France
Great Britain
India
Israel
Italia
Japan

México
Nederland
Norge
Österreich
Polska
România
Russia
Schweiz
Singapore
Slovenija
South Africa
South Korea
Suomi
Sverige
Taiwan
Türkiye
United Arab Emirates
USA

Please find detailed addresses and additional representatives and agencies in all major industrial nations at www.sick.com